

17.5 mm - 1 Solid State Relay 0.7A MUS2 Part number 88827004



- Multi-function or mono-function
- Multi-range
- Multi-voltage
- Screw or spring terminals
- LED status indicator (relay version)
- Possibility of external load connection in parallel to the control input
- 3-wire PNP sensor compatible

Part numbers

	Type	Functions	Timing	Output	Nominal rating	Connections	Supply voltage
88 827 004	MUS2	A - Ac - At - B - Bw - C - D - Di - H - Ht	0,1 s → 100 h	Solid state	0,7 A	Screw terminals	24 → 240 V AC

Specifications

Timing

Timing ranges (7 ranges)	1 s - 10 s - 1 min - 10 min - 1 h - 10 h - 100 h
Repetition accuracy with constant parameters	± 0.5 % (IEC/EN 61812-1)
Drift Temperature	± 0,05 % / °C
Drift Voltage	± 0,2 % / V
Display accuracy according to IEC/EN 61812-1	± 10 % / 25 °C
Immunity from micro power cuts : typical	< 10 ms

Supply

Multi-voltage power supply	Depending on version
Frequency (Hz)	50 / 60
Operating factor	100 %

Output specification

Rated power	2000 VA/80 W
Maximum breaking current	8 AAC 250 VAC resistive 8 ADC 30 VDC resistive
Minimum breaking current	10 mA / 5 VDC
Voltage breaking capacity	250 VAC / 8 AAC resistive 250 VDC / 0,3 A resistive
Electrical life (operations)	10 ⁵ 8 A 250 VAC resistive
Mechanical life (operations)	10 x 10 ⁶
Breakdown voltage acc. to IEC/EN 61812-1	2,5 kV / 1 min / 1 mA / 50 Hz
Impulse voltage acc. to IEC/EN 60664-1, IEC/EN 61812-1	5 kV wave 1.2 / 50 µs

General characteristics

Conformity to standards	IEC/EN 61812-1 IEC/EN 61000-6-1 IEC/EN 61000-6-2 IEC/EN 61000-6-3 IEC/EN 61000-6-4
Certifications	CE, UL, cUL, CSA, GL
Temperature limits use (°C)	-20 → +60
Temperature limits stored (°C)	-30 → +60
Installation category (acc. to IEC/EN 60664-1)	Voltage surge category III
Creepage distance and clearance acc. to IEC/EN 60664-1	4 kV / 3 mm
Protection (IEC/EN 60529)	IP20 IP40
Degree of protection acc. to IEC/EN 60529 Front face	IP50
Vibration resistance acc. to IEC/EN 60068-2-6	20 m/s ² 10 Hz → 150 Hz
Relative humidity no condensation acc. to IEC/EN 60068-2-30	93 % non-condensing
Electromagnetic compatibility - Immunity to electrostatic discharges acc to IEC/EN 61000-4-2	Level III (Air 8 kV / Contact 6 kV)
Immunity to radiated, radio-frequency, electromagnetic field acc. IEC/EN 61000-4-3	Level I (1 V/m : 2,0 G Hz → 2,7 G Hz) Level II (3 V/m : 1,4 G Hz → 2,0 G Hz)

	Level III (10 V/m : 80 M Hz →1 G Hz)
Immunity to rapid transient bursts acc. to IEC/EN 61000-4-4	Level III (direct 2 kV / Capacitive coupling clamp 1 kV)
Immunity to shock waves on power supply acc. to IEC/EN 61000-4-5	Level III (2 kV / common mode 2 kV/residual current mode 1 kV)
Immunity to radio frequency in common mode acc. to IEC/EN 61000-4-6	Level III (10V rms : 0.15 M Hz to 80 M Hz)
Immunity to voltage dips and breaks acc. to IEC/EN 61000-4-11	0 % residual voltage, 1 cycle 70 % residual voltage, 25/30 cycles
Mains-borne and radiated emissions acc. to EN 55022 (CISPR22), EN55011 (CISPR11)	Class B
Fixing : Symmetrical DIN rail	35 mm
Terminal capacity Single-wire without ferrule	1 x 0,5 →3,3 mm ² (AWG 20 →AWG 12) 2 x 0,5 →2,5 mm ² (AWG 20 →AWG 14)
Terminal capacity Multi-wire with ferrule	1 x 0,5 →2,5 mm ² (AWG 20 →AWG 14) 2 x 0,5 →1,5 mm ² (AWG 20 →AWG 16)
Housing material	Self-extinguishing
Shock test IEC/EN 60068-2-27	15 g - 11 ms
Short interruption on power line acc to IEC/EN 61000-4-11	0 % residual voltage, 250/300 cycles

Timing

Minimum pulse duration typically (relay version)	
Minimum pulse duration typically (solid state version)	
Minimum pulse duration typically (relay version under load)	
Maximum reset time by de-energisation typically (relay version)	
Maximum reset time by de-energisation typically (solid state version)	

Solid state output

Breaking capacity	0,7 A AC / DC 20 °C (0,5 A UL)
Traduction à placer ici	5 mA/ °C
Maximum admissible current	20 A ≤ 10 ms
Minimum breaking current	10 mA
Leakage current	< 5 mA
Voltage breaking capacity	250 VAC / DC
Maximum voltage drop at terminals	3 wire 4V 2 wire 8V
Electrical life (operations)	10 ⁸
Breakdown voltage acc. to IEC/EN 60664-1, IEC/EN 60255-5	2.5 kV to 1 mA / 1 min
Input type	Volt-free contact 3-wire PNP output control option residual voltage : 0.4V whatever the timer power supply

Dimensions (mm)

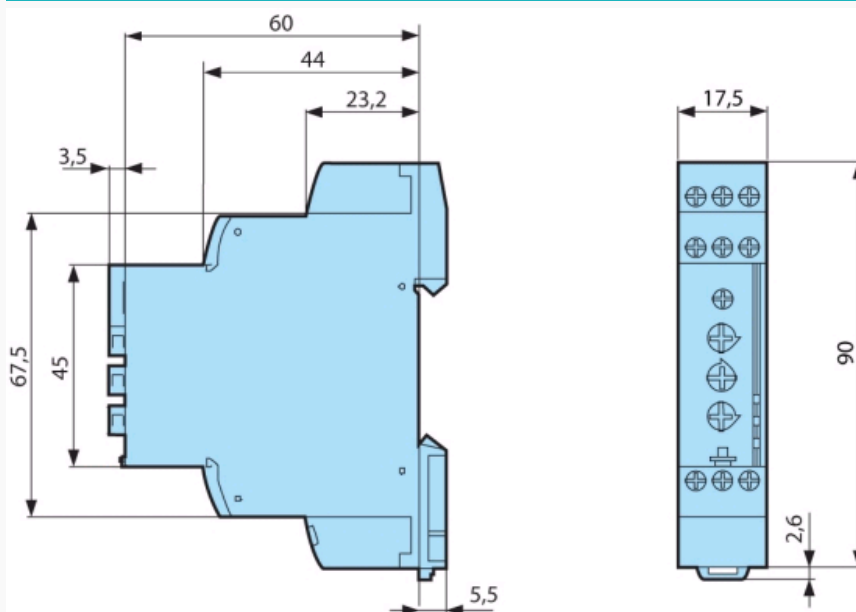

Curves

Function A

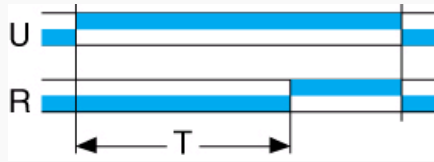

Function A

Delay on energisation 1 relay

Curves

Function Ac

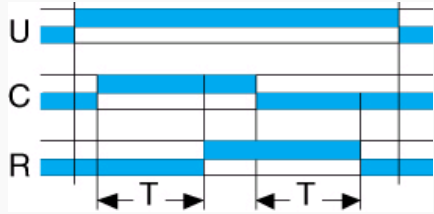

Function Ac

Timing after closing and opening of control contact 1 relay

Curves

Function At

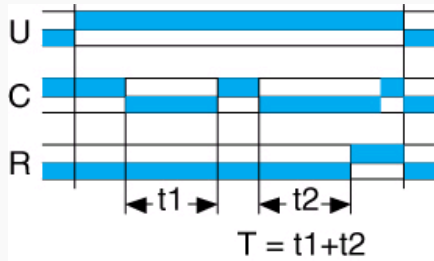

Function At

Timing on energisation with memory 1 relay

Curves

Function B

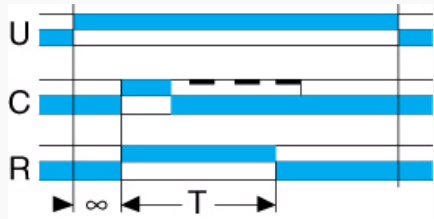

Function B

Timing on impulse one shot 1 relay

Curves

Function Bw

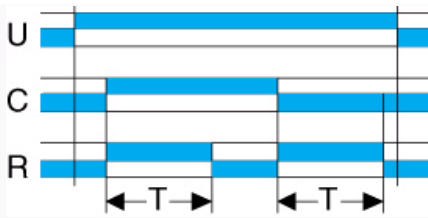

Function Bw
Pulse output (adjustable) 1 relay

Curves

Function C

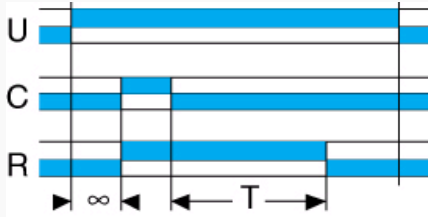

Function C
Timing after impulse 1 relay

Curves

Function D

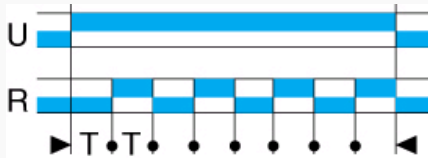

Function D
Flip-flop Pause start 1 relay

Curves

Function Di

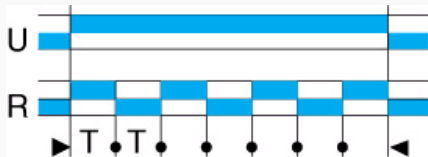

Function Di
Flip-flop Pulse start 1 relay

Curves

Function H



Function H
Timing on energisation 1 relay

Curves

Function Ht

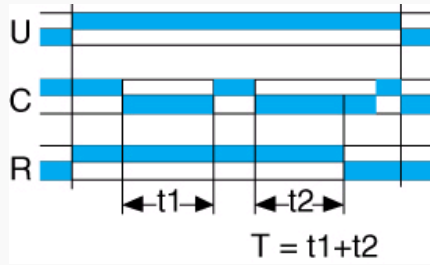

Function Ht

Delay on energisation with memory 1 relay

Connections

Solid state output

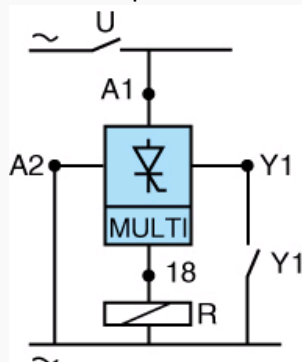

Connections

CA MUS2

CA MUS2