

SAM-M8Q

Easy-to-use u-blox M8 GNSS antenna module

Hardware integration manual



Abstract

This document describes the hardware features and specifications of the SAM-M8Q patch antenna module, which features the u-blox M8 concurrent GNSS engine with reception of GPS, GLONASS, Galileo and QZSS signals.

Document information

Title	SAM-M8Q	
Subtitle	Easy-to-use u-blox M8 GNSS antenna module	
Document type	Hardware integration manual	
Document number	UBX-16018358	
Revision and date	R07	28-May-2020
Document status	Production information	

Product status	Corresponding content status	
In Development / Prototype	Objective Specification	Target values. Revised and supplementary data will be published later.
Engineering Sample	Advance Information	Data based on early testing. Revised and supplementary data will be published later.
Initial Production	Early Production Information	Data from product verification. Revised and supplementary data may be published later.
Mass Production / End of Life	Production Information	Document contains the final product specification.

European Union regulatory compliance

SAM-M8Q smart antenna module complies with all relevant requirements for RED 2014/53/EU. The SAM-M8Q Declaration of Conformity (DoC) is available at www.u-blox.com within Support > Product resources > Conformity Declaration.

This document applies to the following products:

Product name	Type number	Firmware version	PCN reference
SAM-M8Q	SAM-M8Q-0-10	ROM SPG 3.01	N/A

u-blox or third parties may hold intellectual property rights in the products, names, logos and designs included in this document. Copying, reproduction, modification or disclosure to third parties of this document or any part thereof is only permitted with the express written permission of u-blox.

The information contained herein is provided "as is" and u-blox assumes no liability for its use. No warranty, either express or implied, is given, including but not limited to, with respect to the accuracy, correctness, reliability and fitness for a particular purpose of the information. This document may be revised by u-blox at any time without notice. For the most recent documents, visit www.u-blox.com.

Copyright © u-blox AG.



Contents

Document information	2
Contents	3
1 Hardware description	4
1.1 Overview	4
1.2 Configuration	4
1.3 Connecting power	4
1.4 Interfaces.....	5
1.4.1 UART	5
1.4.2 Display data channel (DDC)	5
1.5 I/O pins.....	6
1.5.1 RESET_N: Reset.....	6
1.5.2 EXTINT: External interrupt	6
1.5.3 TIMEPULSE.....	6
1.5.4 SAFEBOOT_N.....	7
1.6 Electromagnetic interference on I/O lines	7
2 Design	8
2.1 Pin description	8
2.2 Minimal design.....	8
2.3 Footprint and paste mask.....	9
2.4 Antenna.....	10
2.5 Embedded antenna operation.....	11
2.6 PCB layout suggestion	12
2.7 Layout design-in: Thermal management.....	12
3 Product handling	14
3.1 Packaging, shipping, storage and moisture preconditioning	14
3.2 Soldering	14
3.3 EOS/ESD/EMI precautions.....	17
3.3.1 Electromagnetic interference (EMI)	18
3.4 Applications with cellular modules.....	18
Appendix	21
A Glossary	21
B Recommended parts	21
Related documents	22
Revision history	22
Contact	23

1 Hardware description

1.1 Overview

The SAM-M8Q module is a concurrent GNSS patch antenna module featuring the high performance u-blox M8 GNSS engine with reception of GPS, GLONASS, Galileo and QZSS signals. Available in an LGA package, it is easy to integrate and combines exceptional positioning performance with highly flexible power, design, and connectivity options. SMT pads allow fully automated assembly with standard pick and place and reflow-soldering equipment for cost-efficient, high-volume production enabling short time-to-market.

-  For product features see the SAM-M8Q Data sheet [1].
-  To determine which u-blox product best meets your needs, see the product selector tables on the u-blox website (www.u-blox.com).

1.2 Configuration



The configuration settings can be modified using UBX protocol configuration messages; see the u-blox 8 / u-blox M8 Receiver Description including Protocol Specification [2]. The modified settings remain effective until power-down or reset. If these settings have been stored in battery-backed RAM (BBR), the modified configuration will be retained, as long as the backup battery supply is not interrupted.

1.3 Connecting power

The SAM-M8Q antenna module has three power supply pins: **VCC**, **VCC_IO** and **V_BCKP**.

VCC: Main supply voltage

The **VCC** pin provides the main supply voltage. During operation, the current drawn by the module can vary by some orders of magnitude, especially if enabling low-power operation modes. For this reason, it is important that the supply circuitry be able to support the peak power for a short time (see the SAM-M8Q Data sheet [1] for specification).

-  When switching from backup mode to normal operation or at start-up, the SAM-M8Q antenna module must charge its internal capacitors in the core domain. In certain situations, this can result in a significant current draw. For low power applications using power save and backup modes, it is important that the power supply or low ESR capacitors at the module input can deliver this current/charge.
-  Use a proper GND concept. Do not use any series resistors, ferrite beads or coils in the power line.
-  The equipment must be supplied by an external limited power source in compliance with the clause 2.5 of the standard IEC 60950-1.



VCC_IO: IO supply voltage

VCC_IO from the host system supplies the digital I/Os. The wide range of **VCC_IO** allows seamless interfacing to standard logic voltage levels independent of the **VCC** voltage level. In many applications, **VCC_IO** is simply connected to the main supply voltage.

-  Without a **VCC_IO** supply, the system will remain in reset state.

V_BCKP: Backup supply voltage

In case of a power failure on the module supply, **V_BCKP** supplies the real-time clock (RTC) and battery backed RAM (BBR). Use of valid time and the GNSS orbit data at start-up improves the GNSS performance, that is, hot starts and warm starts. If no backup battery is connected, the module performs a cold start at power-up.

-  Avoid high resistance on the **V_BCKP** line: During the switch from main supply to backup supply, a short current adjustment peak can cause high voltage drop on the pin with possible malfunctions.
-  If no backup supply voltage is available, connect the **V_BCKP** pin to **VCC_IO**.
-  As long a supply is connected to **VCC_IO** of SAM-M8Q antenna module, the backup battery is disconnected from the RTC and the BBR to avoid unnecessary battery drain (see Figure 1). In this case, **VCC_IO** supplies power to the RTC and BBR. **V_BCKP** supplies the RTC and BBR in case **VCC_IO** voltage goes below 1.4V.

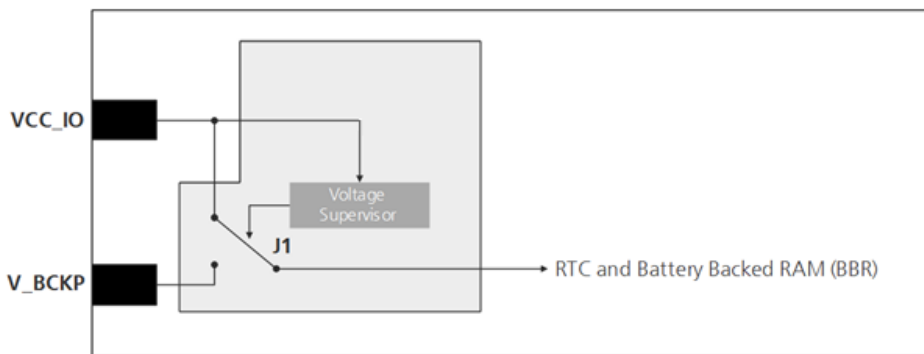

Figure 1: Backup battery and voltage

1.4 Interfaces

1.4.1 UART

The SAM-M8Q antenna module includes a universal asynchronous receiver transmitter (UART) serial interface, **RxD/TxD**, which supports configurable baud rates, as specified in the SAM-M8Q Data sheet [1]. The signal output and input level is 0 V to **VCC_IO**. An interface based on RS232 standard levels (+/- 12 V) can be implemented using level shifters, such as Maxim MAX3232. Hardware handshake signals and synchronous operation are not supported.

1.4.2 Display data channel (DDC)

An I2C-compatible display data channel (DDC) interface is available with SAM-M8Q antenna modules for serial communication with an external host CPU. The interface only supports operation in slave mode (master mode is not supported). The DDC protocol and electrical interface are fully compatible with the Fast-Mode of the I2C industry standard. DDC pins **SDA** and **SCL** have internal pull-up resistors to **VCC_IO**.

For more information about the DDC implementation, see the u-blox 8 / u-blox M8 Receiver Description including Protocol Specification [2]. For bandwidth information, see the SAM-M8Q Data sheet [1]. For timing parameters, consult the I2C-bus specification [6].

-  The SAM-M8Q DDC interface supports serial communication with u-blox cellular modules. See the specification of the applicable cellular module to confirm compatibility.

TX_READY



The **TX_READY** function is used to indicate when the receiver has data to transmit on DDC interface. A listener can wait on the **TX_READY** signal instead of polling the DDC interfaces. The **UBX-CFG-PRT** message lets you configure the polarity and the number of bytes in the buffer before the **TX_READY** signal goes active. The **TX_READY** function can be mapped to **TXD** (PIO 06). The **TX_READY** function is disabled by default.

-  The **TX_READY** functionality can be enabled and configured by AT commands sent to the u-blox cellular module supporting the feature. For more information see the GPS Implementation and Aiding Features in u-blox wireless modules [7].

1.5 I/O pins

1.5.1 RESET_N: Reset

Driving **RESET_N** low activates a hardware reset of the system. Use this pin only to reset the module. Do not use **RESET_N** to turn the module on and off, since the reset state increases power consumption. The SAM-M8Q **RESET_N** pin is for input only.

-  The RTC time is also reset (but not BBR). This means that the hot start performance will be degraded after a reset.
-  No additional capacitance should be added at **RESET_N** pin to GND (otherwise it could cause a reset at startup).

1.5.2 EXTINT: External interrupt

EXTINT is an external interrupt pin with fixed input voltage thresholds with respect to **VCC_IO** (see the SAM-M8Q Data sheet [1] for more information). It can be used for wake-up functions in power save mode on and for aiding. Leave open if unused, function is disabled by default.

If **EXTINT** is not used for an external interrupt function, the pin can be used as a generic PIO (PIO13). The PIO13 can be configured to function, for example, as an output pin for the TXD Ready feature to indicate that the receiver has data to transmit. For further information, see u-blox 8 / u-blox M8 Receiver Description including Protocol Specification [2].

Power control

The power control feature allows overriding the automatic active/inactive cycle of power save mode. The state of the receiver can be controlled through the **EXTINT** pin. The receiver can also be forced OFF using **EXTINT** when power save mode is not active.

Frequency aiding

The **EXTINT** pin can be used to supply time or frequency aiding data to the receiver.

For time aiding, hardware time synchronization can be achieved by connecting an accurate time pulse to the **EXTINT** pin.

Frequency aiding can be implemented by connecting a periodic rectangular signal with a frequency up to 500 kHz and arbitrary duty cycle (low/high phase duration must not be shorter than 50 ns) to the **EXTINT** pin. Provide the applied frequency value to the receiver using UBX messages.

1.5.3 TIMEPULSE

A configurable time pulse signal is available with SAM-M8Q antenna module. By default, the time pulse signal is configured to one pulse per second. For more information see the u-blox 8 / u-blox M8 Receiver Description including Protocol Specification [2].

1.5.4 SAFEBOOT_N

The **SAFEBOOT_N** pin is for future service, updates and reconfiguration.

1.6 Electromagnetic interference on I/O lines

Any I/O signal line with a length greater than approximately 3 mm can act as an antenna and may pick up arbitrary RF signals transferring them as noise into the GNSS receiver. This specifically applies to unshielded lines, in which the corresponding GND layer is remote or missing entirely, and lines close to the edges of the printed circuit board.

If, for example, a cellular signal radiates into an unshielded high-impedance line, it is possible to generate noise in the order of volts and not only distort receiver operation but also damage it permanently.

On the other hand, noise generated at the I/O pins will emit from unshielded I/O lines. Receiver performance may be degraded when this noise is coupled into the GNSS antenna (see Figure 11).

To avoid interference by improperly shielded lines, it is recommended to use resistors (for example, $R > 20 \Omega$), ferrite beads (for example, BLM15HD102SN1) or inductors (for example, LQG15HS47NJ02) on the I/O lines in series. Choose these components with care because they also affect the signal rise times.

Figure 2 shows an example of EMI protection measures on the RXD/TXD line using a ferrite bead. More information can be found in section 3.3.

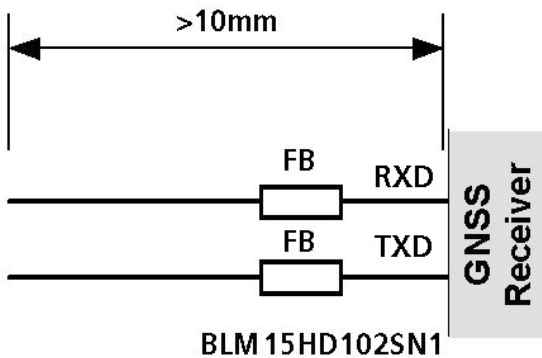

Figure 2: EMI precautions

2 Design

2.1 Pin description

Function	Pin	No.	I/O	Description	Remarks
Power	VCC	17		Main supply	Provide clean and stable supply (low impedance, < 0.2 Ohms).
	GND	1, 4, 5, 6, 10, 11, 15, 16, 20		Ground	Assure a good GND connection to all GND pins of the module.
	VCC_IO	2		VCC_IO	IO supply voltage. Must always be supplied. Usually connect to VCC pin 17.
	V_BCKP	3		Backup supply	It is recommended to connect a backup supply voltage to V_BCKP to enable warm- and hot start features on the positioning module. Otherwise, connect to VCC_IO.
UART	TXD	13	O	Serial port	Can be configured as TX_Ready for DDC interface. Leave open if not used.
	RXD	14	I	Serial port	Leave open if not used.
DDC	SCL	12	I	Serial port	Leave open if not used.
	SDA	9	I/O	Serial port	Leave open if not used.
System	RESET_N	18	I	Reset (Active Low)	Leave open if not used. Do not drive high. Do not connect a capacitor at this pin.
	TIMEPULSE	7	O	1PPS	Configurable timepulse signal (one pulse per second by default). Leave open if not used.
	EXTINT / PIO13	19	I	Ext. interrupt	Leave open if not used. The pin can also be used as a generic PIO (PIO13).
	SAFEBOOT_N	8	I		Leave open.

Table 1: SAM-M8Q pinout

2.2 Minimal design

This is a minimal setup for a SAM-M8Q GNSS antenna module:

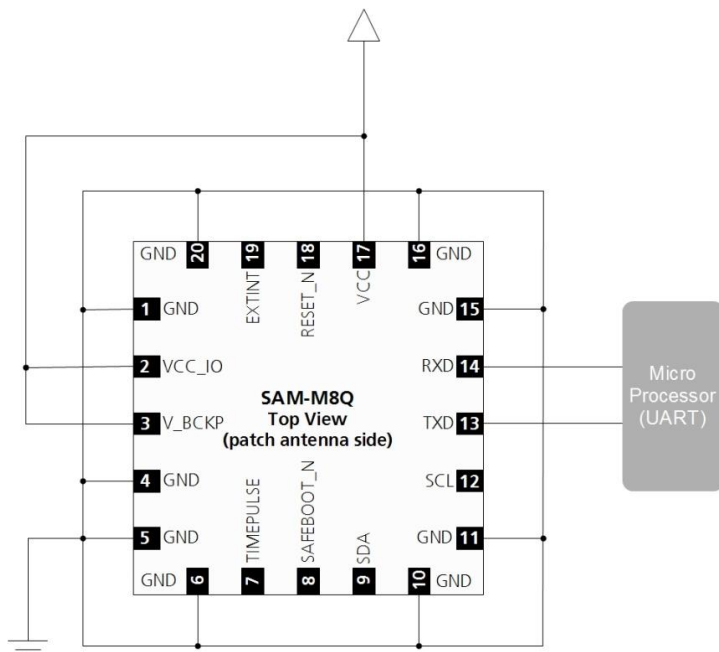

Figure 3: SAM-M8Q GNSS patch antenna design

2.3 Footprint and paste mask

The suggested solder mask openings are the same as the pad layout.

- Be sure to comply with special PCB layout design rules to ensure proper embedded antenna operation when the customer PCB is used as part of antenna. This requires solid ground plane around the module, see section 2.6 for PCB layout suggestions.

Footprint

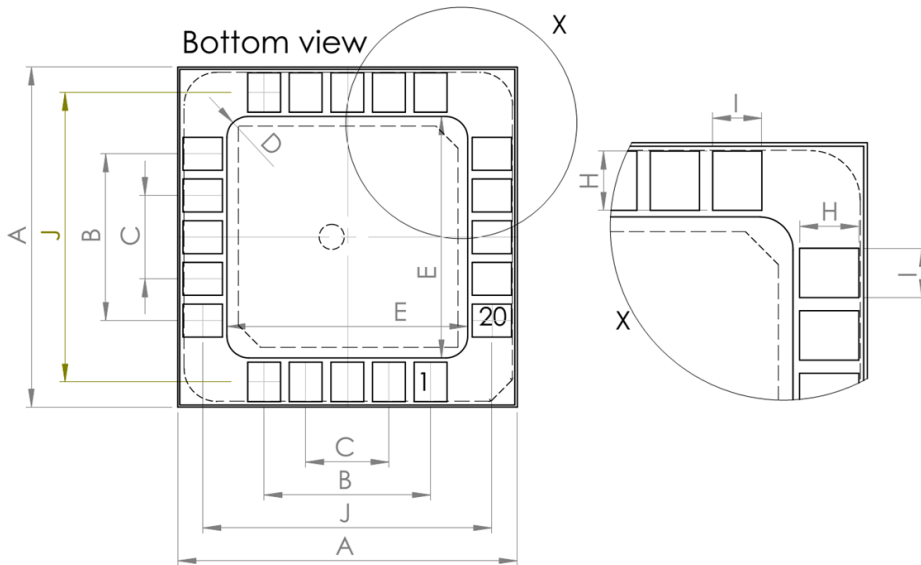

Figure 4: SAM-M8Q footprint

Symbol	Typical [mm]
A	15.50
B	7.60
C	3.80
D	R1.00
E	11.00
F	6.30
H	1.80
I	1.50
J	13.20

Table 2: SAM-M8Q footprint dimensions

Paste mask

- Stencil thickness: 120 μm
- Orange: Pad
- Grey: stencil opening

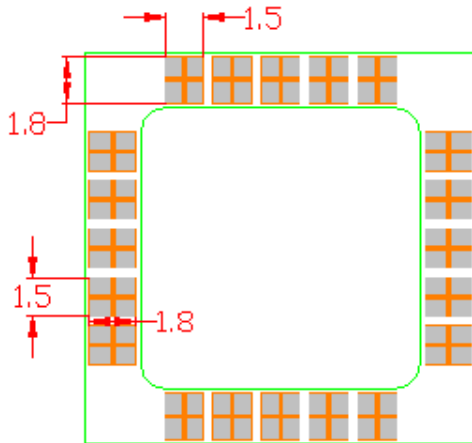

Figure 5: Suggested pad layout and occupied area, top view

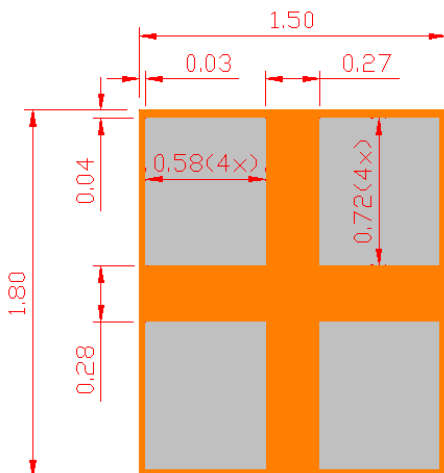

Figure 6: Paste mask detail for each pad

2.4 Antenna

SAM-M8Q GNSS patch antenna module is designed with an integrated GPS/Galileo/GLONASS patch antenna.

Antenna input

The module has an embedded GNSS patch antenna and a SAW band-pass filter before LNA, which provides excellent protection against out-of-band GNSS blocking caused by possible near-by wireless transmitters. The signal is further amplified by the internal low noise amplifier (LNA) inside u-blox's UBX-M8030 GNSS chip.

- Be sure to comply with special PCB layout design rules to ensure proper embedded antenna operation when the customer PCB is used as part of antenna. This requires solid ground plane around the module, see section 2.6 for PCB layout suggestions.

2.5 Embedded antenna operation

The embedded GPS/Galileo/GLONASS patch antenna provides optimal performance in the middle of a 50 x 50 mm ground plane.

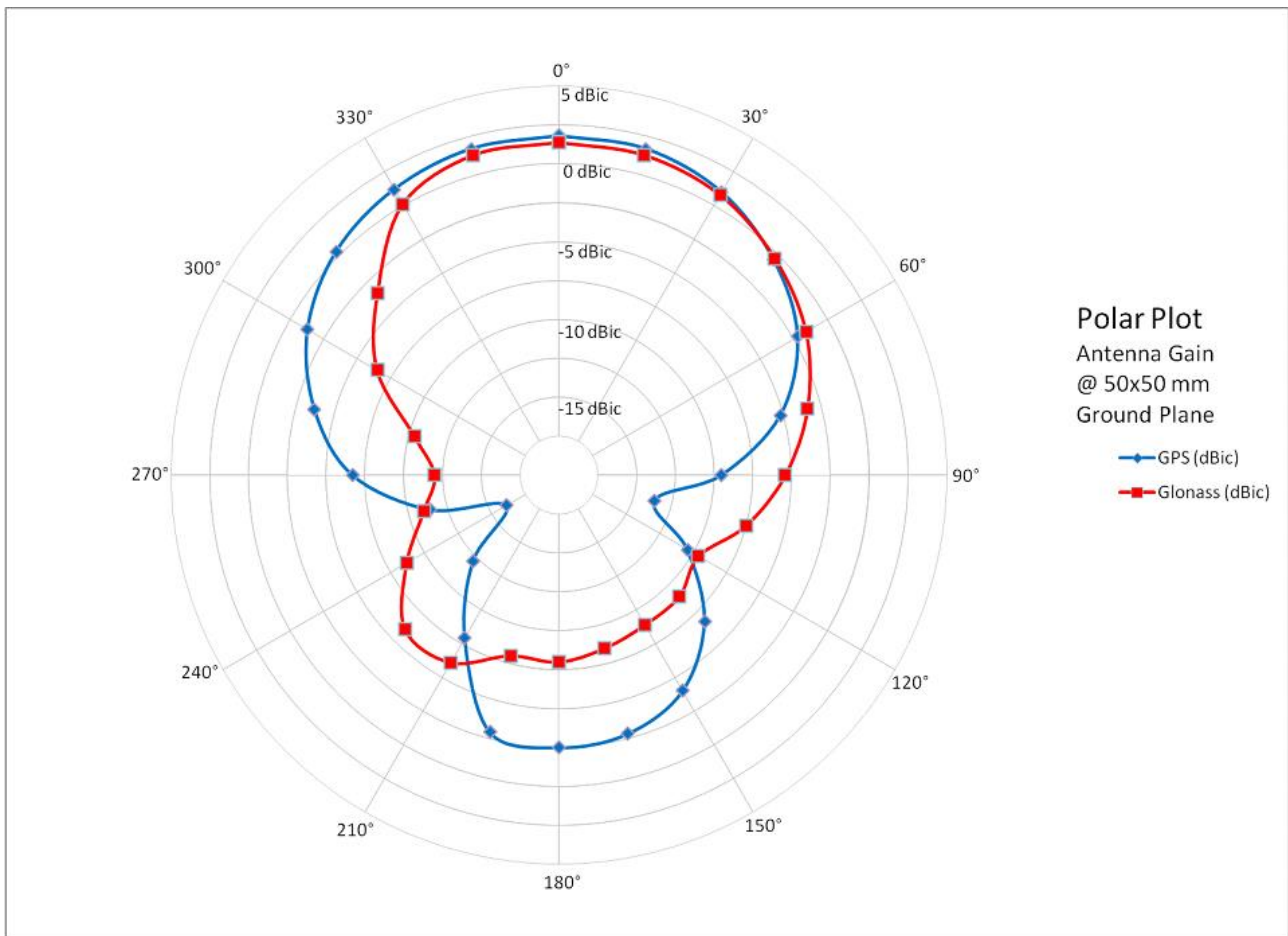

Figure 7: 1.575 GHz typical free space radiation patterns

Place any tall nearby components ($h > 3$ mm) at least 10 mm away from the SAM-M8Q module. An enclosure or plastic cover should have a minimum distance of 5 mm to the antenna.

Placement near a human body (or any biological tissue) can be acceptable by keeping a minimum distance of 10 mm between motherboard and the body. With smaller distances to the body, the radiation efficiency of the antenna will start to reduce due to signal losses in biological tissue.

2.6 PCB layout suggestion

For good performance, it is essential to have a proper layout and placement.

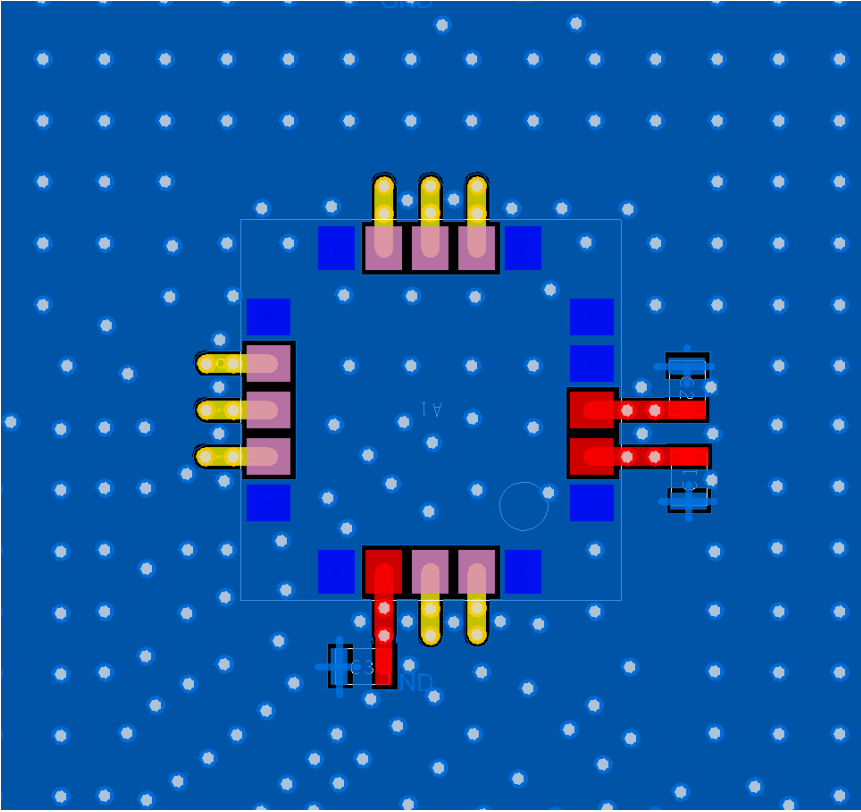

Figure 8: Layout recommendation (top layer)

SAM-M8Q GNSS patch antenna module is intended to be placed in the middle of 50 x 50 mm GND size board, but a larger or a smaller ground plane can also be used. When using a smaller than 40 x 40 mm ground plane, the performance may decrease significantly.

Some important recommendations:

- Easy to connect, but make sure all noisy lines / components are shielded or on inner layers.
- Do not place any noisy parts close to SAM-M8Q, place them as far away as possible or on other side of the PCB.
- It is recommended not to place anything closer than 1 cm to each edge of SAM-M8Q.
- Performance decreases significantly if GND size is smaller than 40 x 40 mm.
- Use at least one layer for solid GND plane, preferably the layer SAM-M8Q is placed on.
- Use a solid GND plane under SAM-M8Q, which forms the shield. No signal traces are allowed below SAM-M8Q.
- Route signal traces away from the module on top layer.
- When necessary, allow signal swap from top to bottom layer clearly away from the module, > 20 mm.
- Use copper pour ground planes on the top and bottom layers; use multiple GND net via holes to tie separate ground plane areas tightly together.

2.7 Layout design-in: Thermal management

During design-in do not place the module near sources of heating or cooling. The receiver oscillator is sensitive to sudden changes in ambient temperature which can adversely impact satellite signal tracking. Sources can include co-located power devices, cooling fans or thermal conduction via the PCB. Take into account the following questions when designing in the module.

- Is the receiver placed away from heat sources?
- Is the receiver placed away from air-cooling sources?
- Is the receiver shielded by a cover/case to prevent the effects of air currents and rapid environmental temperature changes?

 High temperature drift and air vents can affect the GNSS performance. For best performance, avoid high temperature drift and air vents near the module.

3 Product handling

3.1 Packaging, shipping, storage and moisture preconditioning

For information pertaining to reels and tapes, moisture sensitivity levels (MSL), shipment and storage information, as well as drying for preconditioning see the SAM-M8Q Data sheet [1].

Population of modules

 When populating the modules, make sure that the pick and place machine is aligned to the copper pins of the module and not to the module edge.

3.2 Soldering

Soldering paste

Use of "no clean" soldering paste is highly recommended, as it does not require cleaning after the soldering process has taken place. The paste in the example below meets these criteria.

Soldering paste:	OM338 SAC405 / Nr.143714 (Cookson Electronics)
Alloy specification:	Sn 95.5/ Ag 4/ Cu 0.5 (95.5% tin/ 4% silver/ 0.5% copper)
Melting temperature:	217 °C
Stencil thickness:	120 um

The final choice of the soldering paste depends on the approved manufacturing procedures.

The paste-mask geometry for applying soldering paste should meet the recommendations.

Reflow soldering

A convection-type soldering oven is highly recommended over the infrared-type radiation oven. Convection-heated ovens allow precise control of the temperature, and all parts will heat up evenly, regardless of material properties, thickness of components and surface color.

As a reference, see the "IPC-7530 Guidelines for temperature profiling for mass soldering (reflow and wave) processes", published in 2001.

Preheat phase

During the initial heating of component leads and balls, residual humidity will be dried out. Note that this preheat phase will not replace prior baking procedures.

- Temperature rise rate: max. 3 °C/s. If the temperature rise is too rapid in the preheat phase it may cause excessive slumping.
- Time: 60 - 120 s. If the preheat is insufficient, rather large solder balls tend to generate. Conversely, if performed excessively, fine balls and large balls will be generated in clusters.
- End temperature: 150 - 200 °C. If the temperature is too low, non-melting tends to be caused in areas containing large heat capacity.

Heating/ Reflow phase

The temperature rises above the liquidus temperature of 217 °C. Avoid a sudden rise in temperature as the slump of the paste could become worse.

- Limit time above 217 °C liquidus temperature: 40 - 60 s
- Peak reflow temperature: 245 °C

Cooling phase

A controlled cooling avoids negative metallurgical effects of the solder (the solder becomes more brittle) and possible mechanical tensions in the products. Controlled cooling helps to achieve bright solder fillets with a good shape and low contact angle.

- Temperature fall rate: max 4 °C/s

 To avoid falling off, place the SAM-M8Q antenna module on the topside of the motherboard during soldering.

The final soldering temperature chosen at the factory depends on additional external factors like choice of soldering paste, size, thickness and properties of the baseboard. Exceeding the maximum soldering temperature in the recommended soldering profile may permanently damage the module.

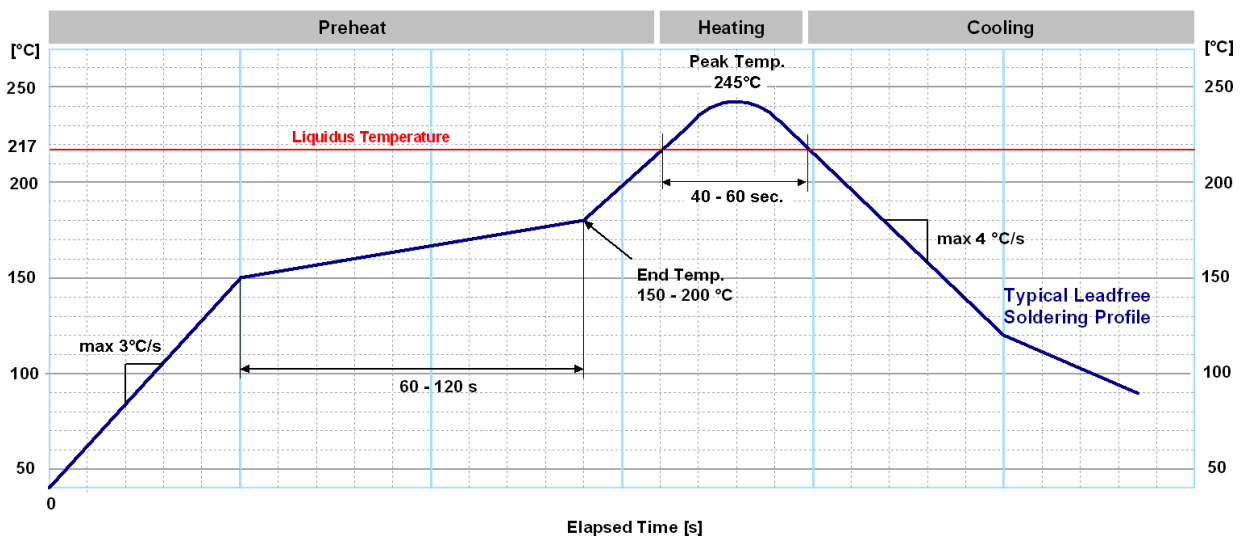



Figure 9: Recommended soldering profile

 SAM-M8Q module **must not** be soldered with a damp heat process.

Optical inspection

After soldering the SAM-M8Q antenna module, consider an optical inspection step to check whether:

- The module is properly aligned and centered over the pads.

Cleaning

In general, cleaning the populated modules is strongly discouraged. Residues underneath the modules cannot be easily removed with a washing process.

- Cleaning with water will lead to capillary effects where water is absorbed into the gap between the baseboard and the module. The combination of residues of soldering flux and encapsulated water leads to short circuits or resistor-like interconnections between neighboring pads.
- Cleaning with alcohol or other organic solvents can result in soldering flux residues flooding into the two housings, areas that are not accessible for post-wash inspections. The solvent will also damage the sticker and the ink-jet printed text.
- Ultrasonic cleaning will permanently damage the module, in particular the quartz oscillators.

The best approach is to use a "no clean" soldering paste and eliminate the cleaning step after the soldering.

Repeated reflow soldering

Only single reflow soldering process is recommended for boards populated with SAM-M8Q GNSS patch antenna module. To avoid upside down orientation during the second reflow cycle, do not submit the SAM-M8Q antenna module to two reflow cycles on a board populated with components on both sides. In such a case, the modules should always be placed on the side of the board that is submitted into the last reflow cycle. This is because of the risk of the module falling off due to the significantly higher weight in relation to other components.

 Repeated reflow soldering processes and soldering the module upside down are not recommended.

Wave soldering

Baseboards with combined through-hole technology (THT) components and surface-mount technology (SMT) devices require wave soldering to solder the THT components. Only a single wave soldering process is encouraged for boards populated with SAM-M8Q antenna module.

Rework

The SAM-M8Q module can be unsoldered from the baseboard using a hot air gun. When using a hot air gun for unsoldering the module, a maximum of one reflow cycle is allowed. In general, we do not recommend using a hot air gun because this is an uncontrolled process and might damage the module.

 Attention: use of a hot air gun can lead to overheating and severely damage the module. Always avoid overheating the module.

After the module is removed, clean the pads before placing and hand soldering a new module.

 Never attempt a rework on the module itself, for example, replacing individual components. Such actions immediately terminate the warranty.

Conformal coating

Certain applications employ a conformal coating of the PCB using HumiSeal® or other related coating products. These materials affect the HF properties of the GNSS patch antenna module.

 Conformal coating of the module will void the warranty.

Casting

These materials affect the HF properties of the GNSS patch antenna including resonant frequency shifts and are not suggested with SAM-M8Q.

 Casting will void the warranty.

Use of ultrasonic processes

Some components on the SAM-M8Q module is sensitive to ultrasonic waves. Use of any ultrasonic processes (cleaning, welding, and so on) may cause damage to the GNSS receiver.



 u-blox offers no warranty against damages to the SAM-M8Q antenna module caused by any ultrasonic processes.

Oxidation of patch antenna

The patch antenna is metalized by silver paste and thus tends to oxidize and changes color. This is normal and is not a case for warranty.

3.3 EOS/ESD/EMI precautions

When integrating GNSS positioning modules into wireless systems, consider electromagnetic and voltage susceptibility issues carefully. Wireless systems include components that can produce electrical overstress (EOS) and electro-magnetic interference (EMI). CMOS devices are more sensitive to such influences because their failure mechanism is defined by the applied voltage, whereas bipolar semiconductors are more susceptible to thermal overstress. The following design guidelines are provided to help in designing robust yet cost-effective solutions.

-  To avoid overstress damage during production or in the field it is essential to observe strict EOS/ESD/EMI handling and protection measures.
-  To prevent overstress damage at the RF_IN of your receiver, never exceed the maximum input power (see the SAM-M8Q Data sheet [1]).

Electrostatic discharge (ESD)

Electrostatic discharge (ESD) is the sudden and momentary electric current that flows between two objects at different electrical potentials caused by direct contact or induced by an electrostatic field. The term is usually used in the electronics and other industries to describe momentary unwanted currents that may cause damage to electronic equipment.





ESD handling precautions

ESD prevention is based on establishing an electrostatic protective area (EPA). The EPA can be a small working station or a large manufacturing area. The main principle of an EPA is that there are no highly charging materials near ESD-sensitive electronics, all conductive materials are grounded, workers are grounded, and charge build-up on ESD-sensitive electronics is prevented. International standards are used to define typical EPA and can be obtained, for example, from International Electrotechnical Commission (IEC) or American National Standards Institute (ANSI).

GNSS positioning modules are sensitive to ESD and require special precautions when handling. Exercise particular care when handling patch antennas, due to the risk of electrostatic charges. In addition to standard ESD safety practices, take the following measures into account whenever handling the receiver.

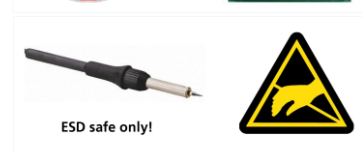
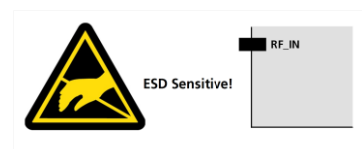
- Unless there is a galvanic coupling between the local GND (i.e. the work table) and the PCB GND, the first point of contact when handling the PCB must always be between the local GND and PCB GND.
- Before mounting an antenna patch, connect ground of the device
- When handling the RF pin, do not come into contact with any charged capacitors and be careful when contacting materials that can develop charges (e.g. patch antenna ~10 pF, coax cable ~50 - 80 pF/m, soldering iron).
- To prevent electrostatic discharge through the RF input, do not touch any exposed antenna area. If there is any risk that such exposed antenna area is touched in a non-ESD protected work area, implement proper ESD protection measures in the design.
- When soldering RF connectors and patch antennas to the receiver's RF pin, make sure to use an ESD safe soldering iron (tip).



-  Failure to observe these precautions can result in severe damage to the GNSS module!
-  GNSS positioning modules are sensitive to electrostatic discharge (ESD). Special precautions are required when handling.

Electrical overstress (EOS)

Electrical overstress (EOS) usually describes situations when the maximum input power exceeds the maximum specified ratings. EOS failure can happen if RF emitters are close to a GNSS receiver or its antenna. EOS causes damage to the chip structures. If EOS damages the RF_IN, it is hard to determine whether the chip structures have been damaged by ESD or EOS.

EOS protection measures

-  For designs with GNSS positioning modules and wireless (for example, GSM/GPRS) transceivers in close proximity, ensure sufficient isolation between the wireless and GNSS antennas. If wireless power output causes the specified maximum power input at the GNSS RF_IN to be exceeded, employ EOS protection measures to prevent overstress damage.

3.3.1 Electromagnetic interference (EMI)

Electromagnetic interference (EMI) is the addition or coupling of energy originating from any RF emitting device. This can cause a spontaneous reset of the GNSS receiver or result in unstable performance. Any unshielded line or segment (>3 mm) connected to the GNSS receiver can effectively act as antenna and lead to EMI disturbances or damage.

The following elements are critical regarding EMI:

- Unshielded connectors (such as pin rows)
- Weakly shielded lines on PCB (for example, on top or bottom layer and especially at the border of a PCB)
- Weak GND concept (for example, small and/or long ground line connections)

EMI protection measures are recommended when RF emitting devices are near the GNSS receiver. To minimize the effect of EMI a robust grounding concept is essential. To achieve electromagnetic robustness follow the standard EMI suppression techniques.

<http://www.murata.com/products/emc/knowhow/index.html>
<http://www.murata.com/products/emc/knowhow/pdf/4to5e.pdf>

Improved EMI protection can be achieved by inserting a resistor (for example, $R > 20 \Omega$), or, better yet, a ferrite bead (BLM15HD102SN1) or an inductor (LQG15HS47NJ02), into any unshielded PCB lines connected to the GNSS receiver. Place the resistor as close to the GNSS receiver pin as possible.

Alternatively, feed-through capacitors with good GND connection can be used to protect against EMI. A selection of feed-through capacitors is listed in Table 4.

Intended use

-  In order to mitigate any performance degradation of a radio equipment under EMC disturbance, system integration shall adopt appropriate EMC design practice and not contain cables over three meters on signal and supply ports.

3.4 Applications with cellular modules

GSM terminals transmit power levels up to 2 W (+33 dBm) peak, 3G and LTE up to 250 mW continuous. Consult the corresponding product data sheet for the absolute maximum power input at the GNSS receiver.

See the GPS Implementation and Aiding Features in u-blox wireless modules [7].

Isolation between GNSS and cellular antenna

In a handheld type design, an isolation of approximately 20 dB can be reached with careful placement of the antennas. If such isolation cannot be achieved, for example, in the case of an integrated cellular /GNSS antenna, an additional input filter is needed on the GNSS side to block the high energy emitted by the cellular transmitter. Examples of these kinds of filters would be the SAW Filters from Epcos (B9444 or B7839) or Murata.

Increasing interference immunity

Interference signals come from in-band and out-band frequency sources.

In-band interference

With in-band interference, the signal frequency is very close to the GNSS constellation frequency used, for example, GPS frequency of 1575 MHz (see Figure 10). Such interference signals are typically caused by harmonics from displays, micro-controller, bus systems, and so on.

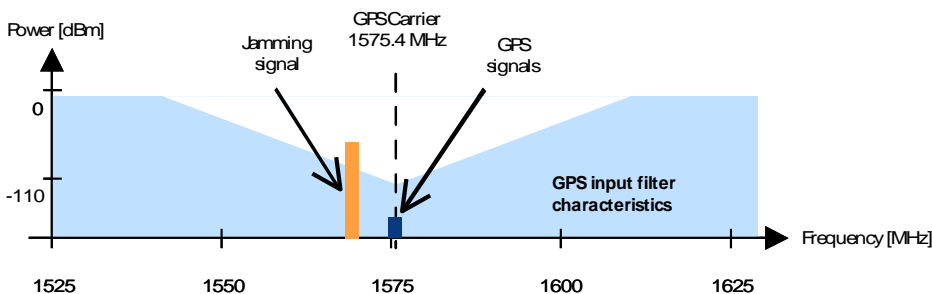

Figure 10: In-band interference signals

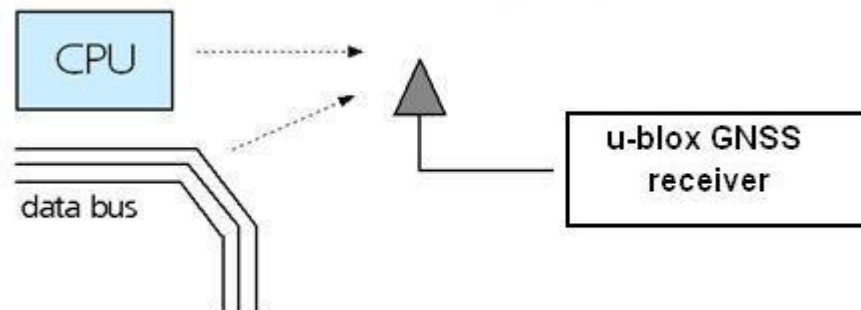

Figure 11: In-band interference sources

Measures against in-band interference include:

- Maintaining a good grounding concept in the design
- Shielding
- Layout optimization
- Filtering
- Placement of the GNSS antenna
- Adding a CDMA, cellular, WCDMA band pass filter before handset antenna

Out-band interference

Out-band interference is caused by signal frequencies that are different from the GNSS carrier (see Figure 12). The main sources are wireless communication systems such as cellular, CDMA, WCDMA, Wi-Fi, BT.

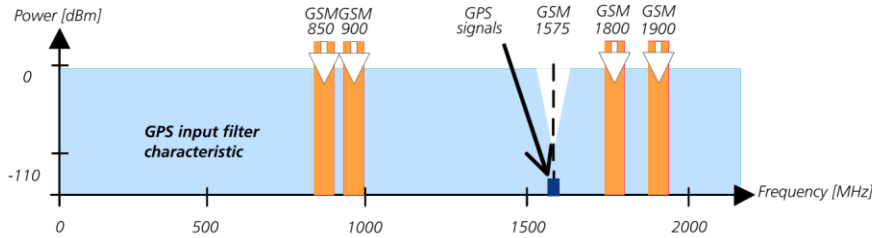

Figure 12: Out-band interference signals

Measures against out-band interference include maintaining a good grounding concept in the design and keep enough distance in between the antennas.

See the GPS Implementation and Aiding Features in u-blox wireless modules [7].

Appendix

A Glossary

Abbreviation	Definition
ANSI	American National Standards Institute
CDMA	Code Division Multiple Access
EMC	Electromagnetic compatibility
EMI	Electromagnetic interference
EOS	Electrical Overstress
EPA	Electrostatic Protective Area
ESD	Electrostatic discharge
Galileo	European navigation system
GLONASS	Russian satellite system
GND	Ground
GNSS	Global Navigation Satellite System
GPS	Global Positioning System
GSM	Global System for Mobile Communications
IEC	International Electrotechnical Commission
PCB	Printed circuit board
QZSS	Quasi-Zenith Satellite System

Table 3: Explanation of the abbreviations and terms used

B Recommended parts

Recommended parts are selected on data sheet basis only. Other components may also be used.

Part	Manufacturer	Part ID	Remarks	Parameters to consider
Ferrite bead	Murata	BLM15HD102SN1	FB	High IZI at fGSM
Feed-through capacitor for signal	Murata	NFL18SP157X1A3	Monolithic type	For data signals, 34 pF load capacitance
		NFA18SL307V1A45	Array type	For data signals, 4 circuits in 1 package
Feed-through capacitor	Murata	NFM18PC	0603 2A	Rs < 0.5 Ω
		NFM21P....	0805 4A	

Table 4: Recommended parts

Related documents

- [1] SAM M8Q Data sheet, [UBX-16012619](#)
- [2] u-blox 8 / u-blox M8 Receiver Description Including Protocol Specification, [UBX-13003221](#)
- [3] GNSS FW3.01 Release Notes (Public version), [UBX-16000319](#)
- [4] GPS Antenna Application Note, GPS-X-08014
- [5] GPS Compendium, GPS-X-02007
- [6] I2C-bus specification, Rev. 6 - 4 April 2014,
http://www.nxp.com/documents/user_manual/UM10204.pdf
- [7] GNSS Implementation in Cellular Modules, [UBX-13001849](#)

 For regular updates to u-blox documentation and to receive product change notifications, register on our homepage (www.u-blox.com).

Revision history

Revision	Date	Name	Comments
R01	25-Nov-2016	mdur	Initial release
R02	22-Dec-2016	mdur	Added the preface page and the document status (Objective Specification), minor update in Table 2.
R03	14-Feb-2017	mdur	Advance Information
R04	13-Mar-2017	mdur	Early Production Information
R05	24-Oct-2017	mdur	Production Information, added information on RED DoC in European Union regulatory compliance (page 2), added Intended use statement in section 3.3.1 Electromagnetic interference (EMI)
R06	29-Jan-2019	mdur	Added information on EXTINT pin usage as generic PIO13 in Section 1.5.2 and Table 1: SAM-M8Q pinout
R07	28-May-2020	mala	Added section 2.7 Layout design-in: Thermal management. Editorial changes to reflect the latest style guide updates.

Contact

For complete contact information, visit us at www.u-blox.com.

u-blox Offices

North, Central and South America

u-blox America, Inc.

Phone: +1 703 483 3180

E-mail: info_us@u-blox.com

Regional Office West Coast:

Phone: +1 408 573 3640

E-mail: info_us@u-blox.com

Technical Support:

Phone: +1 703 483 3185

E-mail: support@u-blox.com

Headquarters

Europe, Middle East, Africa

u-blox AG

Phone: +41 44 722 74 44

E-mail: info@u-blox.com

Support: support@u-blox.com

Asia, Australia, Pacific

u-blox Singapore Pte. Ltd.

Phone: +65 6734 3811

E-mail: info_ap@u-blox.com

Support: support_ap@u-blox.com

Regional Office Australia:

Phone: +61 2 8448 2016

E-mail: info_anz@u-blox.com

Support: support_ap@u-blox.com

Regional Office China (Beijing):

Phone: +86 10 68 133 545

E-mail: info_cn@u-blox.com

Support: support_cn@u-blox.com

Regional Office China (Chongqing):

Phone: +86 23 6815 1588

E-mail: info_cn@u-blox.com

Support: support_cn@u-blox.com

Regional Office China (Shanghai):

Phone: +86 21 6090 4832

E-mail: info_cn@u-blox.com

Support: support_cn@u-blox.com

Regional Office China (Shenzhen):

Phone: +86 755 8627 1083

E-mail: info_cn@u-blox.com

Support: support_cn@u-blox.com

Regional Office India:

Phone: +91 80 405 092 00

E-mail: info_in@u-blox.com

Support: support_in@u-blox.com

Regional Office Japan (Osaka):

Phone: +81 6 6941 3660

E-mail: info_jp@u-blox.com

Support: support_jp@u-blox.com

Regional Office Japan (Tokyo):

Phone: +81 3 5775 3850

E-mail: info_jp@u-blox.com

Support: support_jp@u-blox.com

Regional Office Korea:

Phone: +82 2 542 0861

E-mail: info_kr@u-blox.com

Support: support_kr@u-blox.com

Regional Office Taiwan:

Phone: +886 2 2657 1090

E-mail: info_tw@u-blox.com

Support: support_tw@u-blox.com