



MF303x, MF304x, MF306x, MF308x



DESCRIPTION

The MF303x, MF304x, MF306x and MF308x series of devices consist of a GaAs infrared emitting diode optically coupled to a monolithic silicon detector performing the function of a zero voltage crossing bilateral triac driver. They are designed for use with a discrete power triac in the interface of logic systems to equipment powered from 110 to 240 VAC lines.

FEATURES

- Zero Voltage Crossing
- V_{DRM}
 - MF303x 250V
 - MF304x 400V
 - MF306x 600V
 - MF308x 800V
- Mini Flat Package
- Isolation Voltage $3750V_{RMS}$
- Wide Operating Temperature Range $-40^{\circ}C$ to $110^{\circ}C$
- Pb Free and RoHS Compliant
- UL File E91231 for MF304x, MF306x
- Safety Approval Pending for MF303x, MF308x

APPLICATIONS

- Solenoid / Valve Controls
- Light Controls
- AC Motor Drivers
- Temperature Controls
- AC Motor Starters
- Solid State Relays

ORDER INFORMATION

- Available in Tape & Reel

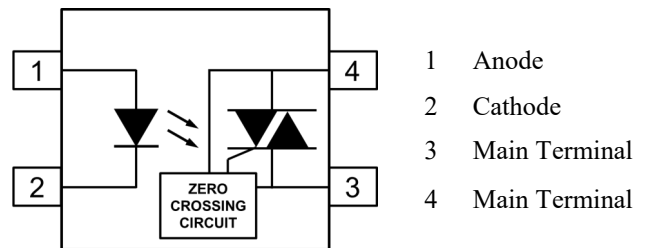

ABSOLUTE MAXIMUM RATINGS

Input

Forward Current	60mA
Peak Forward Current (1 μ s pulse 300pps)	1A
Reverse Voltage	6V
Power Dissipation	100mW

Output

Off-State Output Terminal Voltage	
MF303x	250V
MF304x	400V
MF306x	600V
MF308x	800V
On-state RMS Current	$70mA_{RMS}$
Power Dissipation	300mW

Total Package

Isolation Voltage	$3750V_{RMS}$
Operating Temperature	-40 to $110^{\circ}C$
Storage Temperature	-55 to $150^{\circ}C$
Lead Soldering Temperature (10s)	$260^{\circ}C$

ISOCOM COMPONENTS 2004 LTD

Unit 25B, Park View Road West, Park View Industrial Estate
Hartlepool, Cleveland, TS25 1PE, United Kingdom
Tel : +44 (0)1429 863 609 Fax : +44 (0)1429 863 581
e-mail : sales@isocom.co.uk
<http://www.isocom.com>

ISOCOM COMPONENTS ASIA LTD

Hong Kong Office
Block A, 8/F, Wah Hing Industrial Mansions
36 Tai Yau Street, San Po Kong, Kowloon, Hong Kong
Tel : +852 2995 9217 Fax : +852 8161 6292
e-mail : sales@isocom.com.hk



MF303x, MF304x, MF306x, MF308x

ELECTRICAL CHARACTERISTICS ($T_A = 25^\circ\text{C}$ unless otherwise specified)

INPUT

Parameter	Symbol	Test Condition	Min	Typ.	Max	Unit
Forward Voltage	V_F	$I_F = 30\text{mA}$			1.5	V
Reverse Current	I_R	$V_R = 6\text{V}$			10	μA

OUTPUT

Parameter	Symbol	Test Condition	Min	Typ.	Max	Unit
Peak Off-State Current	I_{DRM}	$V_{\text{DRM}} = \text{Rated } V_{\text{DRM}}$ $I_F = 0\text{mA}$ Note 1			100	nA
On-State Voltage	V_{TM}	$I_{\text{TM}} = 100\text{mA (peak)}$			3	V
Critical Rate of Rise of Off-State Voltage	dv/dt		1000			V/ μs

COUPLED

Parameter	Symbol	Test Condition	Min	Typ.	Max	Unit
Input Trigger Current	I_{FT}	$V_{\text{TM}} = 3\text{V}$ MF3030 / MF3040 MF3060 / MF3080 MF3031 / MF3041 MF3061 / MF3081 MF3032 / MF3042 MF3062 / MF3082 MF3033 / MF3043 MF3063 / MF3083 Note 2			30 15 10 5	V
Holding Current (either direction)	I_{H}			280		μA

Note 1 : Test Voltage must be applied within dv/dt rating.

Note 2 : Guaranteed to trigger at an I_F value less than or equal to max I_{FT} , recommended I_F lies between Rated I_{FT} to Absolute Max I_F .



MF303x, MF304x, MF306x, MF308x

ELECTRICAL CHARACTERISTICS ($T_A = 25^\circ\text{C}$ unless otherwise specified)

ZERO CROSSING CHARACTERISTICS

Parameter	Symbol	Test Condition	Min	Typ.	Max	Unit
Inhibit Voltage	V_{INH}	$I_F = \text{Rated } I_{FT}$ MT1-MT2 Voltage above which device will not trigger			20	V
Leakage Current in Inhibit State	I_{DRM2}	$I_F = \text{Rated } I_{FT}$ $V_{DRM} = \text{Rated } V_{DRM}$ Off-state			1000	μA

ISOLATION

Parameter	Symbol	Test Condition	Min	Typ.	Max	Unit
Isolation Voltage	V_{ISO}	R.H. = 40% to 60% $t = 1 \text{ min}$	3750			V_{RMS}

Measured with input leads shorted together and output leads shorted together.



MF303x, MF304x, MF306x, MF308x

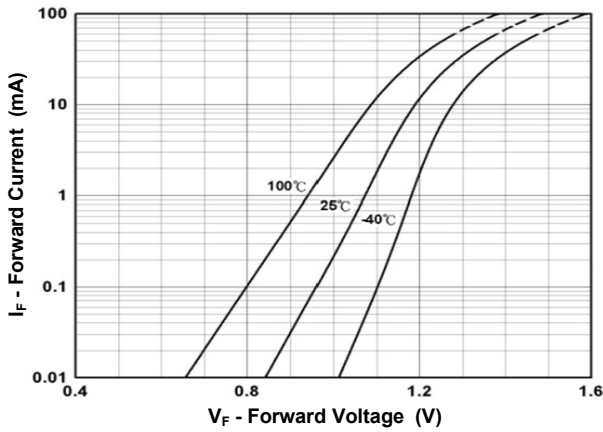

Fig 1 Forward Current vs Forward Voltage

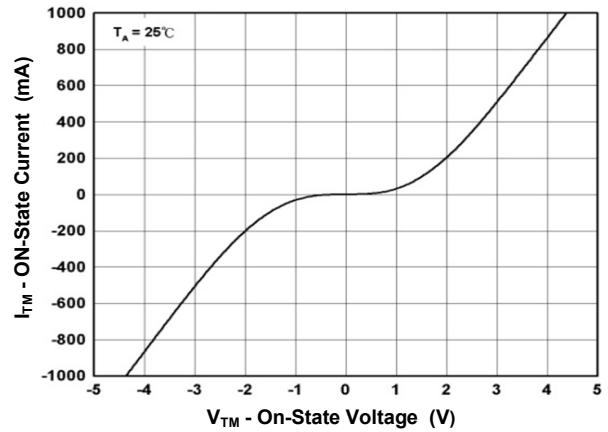

Fig 2 On-State Characteristics

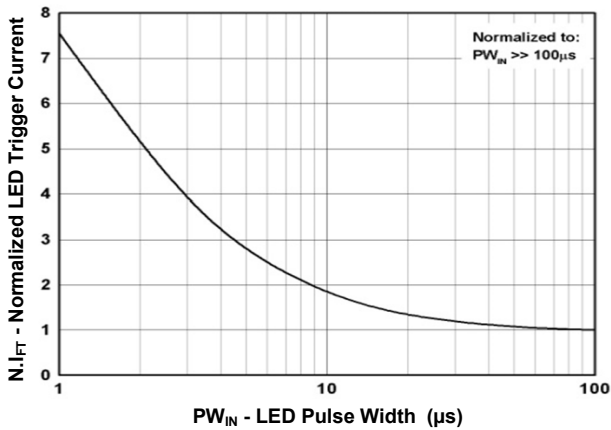

Fig 3 Normalized LED Trigger Current vs LED Pulse Width

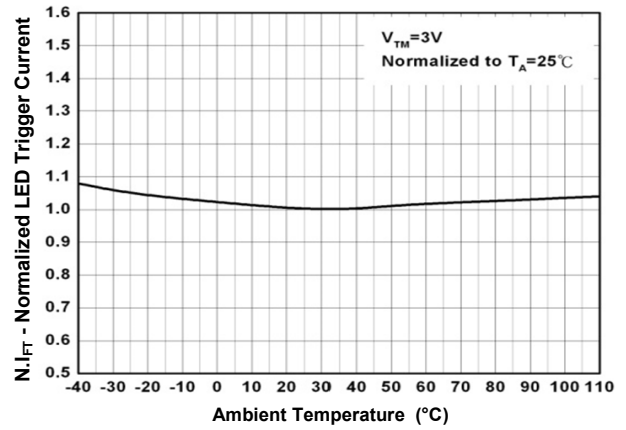

Fig 4 Normalized LED Trigger Current vs Ambient Temperature

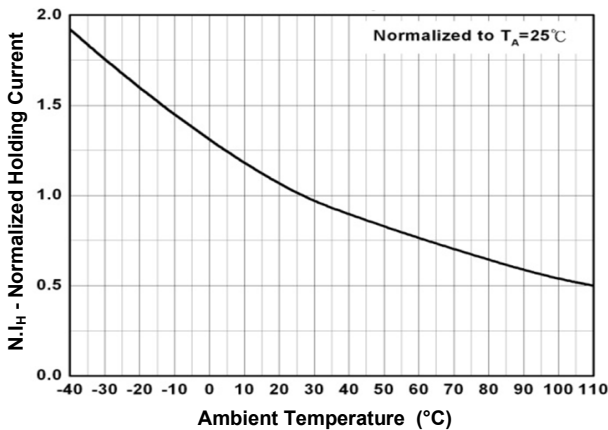

Fig 5 Holding Current vs Ambient Temperature

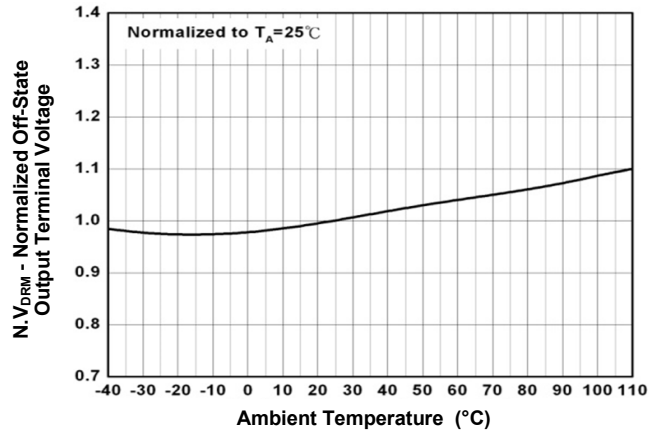

Fig 6 Off-State Output Terminal Voltage vs Ambient Temperature



MF303x, MF304x, MF306x, MF308x

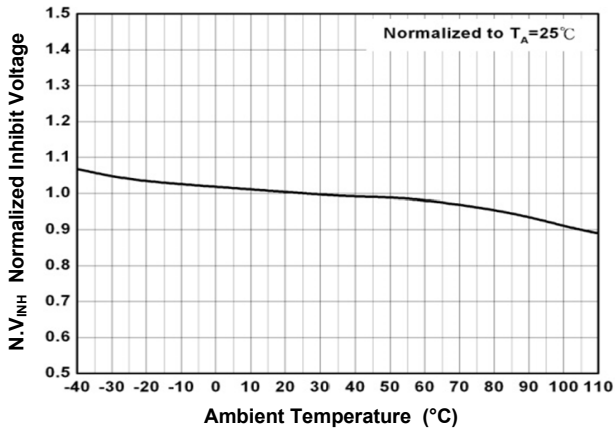

Fig 7 Normalized Inhibit Voltage vs Ambient Temperature

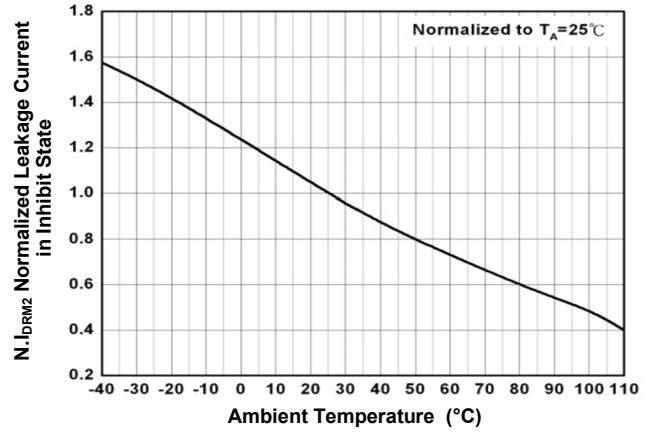

Fig 8 Normalized Leakage Current in Inhibit State vs Ambient Temperature

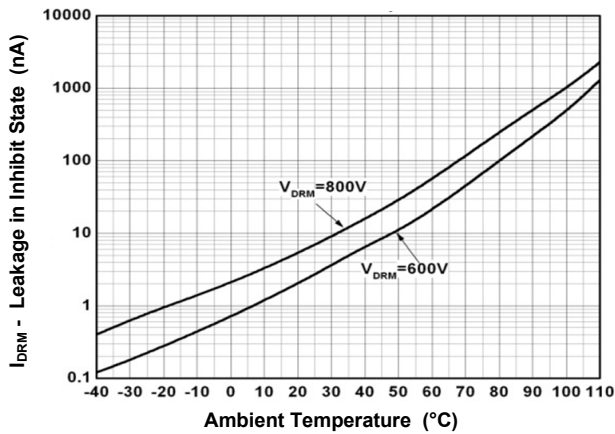

Fig 9 Leakage Current vs Ambient Temperature



MF303x, MF304x, MF306x, MF308x

ORDER INFORMATION

IS281			
After PN	PN	Description	Packing quantity
None	MF3030, MF3031, MF3032, MF3033 MF3040, MF3041, MF3042, MF3043 MF3060, MF3061, MF3062, MF3063 MF3080, MF3081, MF3082, MF3083	Surface Mount Tape & Reel	3000 pcs per reel
<p>NOTE : MF3033 may be supported when ordering MF3030, MF3031, MF3032 MF3043 may be supported when ordering MF3040, MF3041, MF3042 MF3063 may be supported when ordering MF3060, MF3061, MF3062 MF3083 may be supported when ordering MF3080, MF3081, MF3082</p>			

DEVICE MARKING

Note : MF3063 is used as example

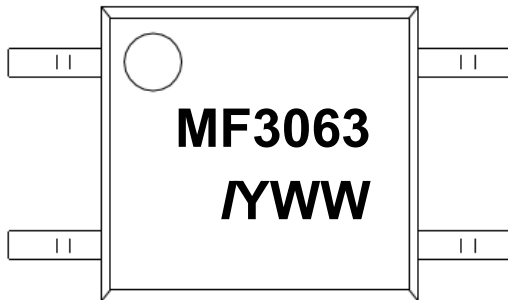

- MF3063 Device Part Number
- I* Isocom
- Y Year Code (A = 2010, B = 2011, etc.)
- WW 2 digit Week Code

Note :	Device	Optional Marking
	MF3033	MF303#
	MF3043	MF304#
	MF3063	MF306# / MF3064
	MF3083	MF308#

MF303x, MF304x, MF306x, MF308x

PACKAGE DIMENSIONS (mm)

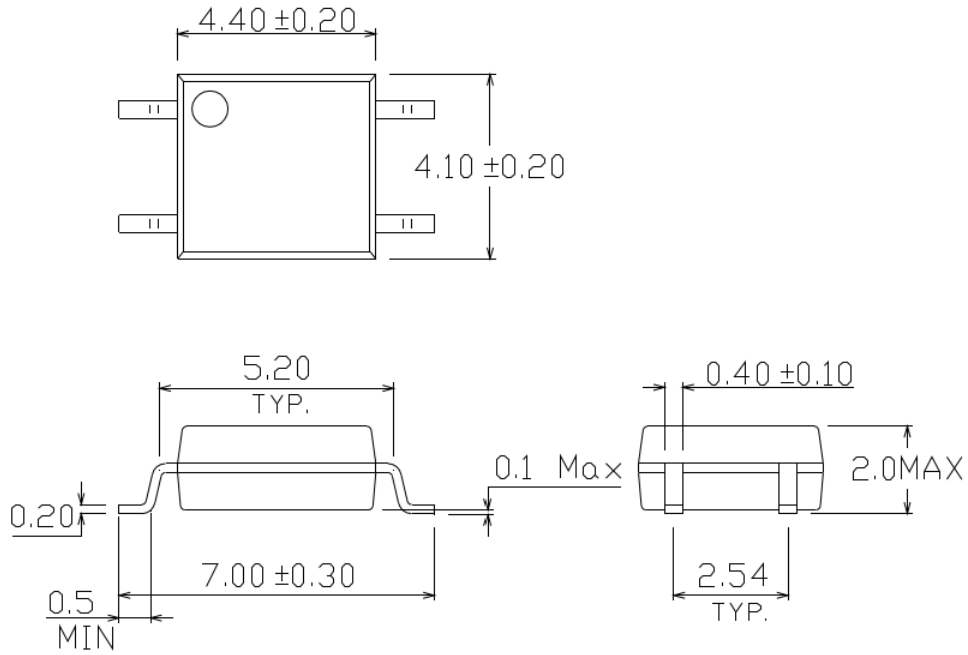

RECOMMENDED PAD LAYOUT (mm)

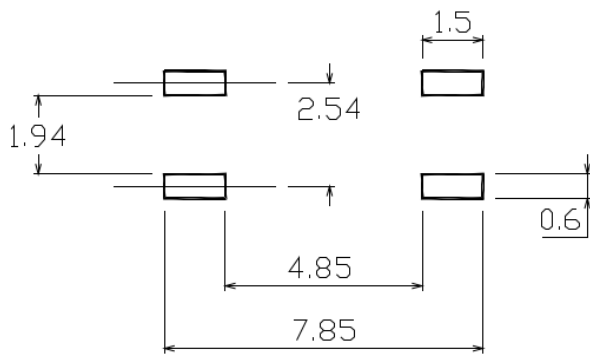



MF303x, MF304x, MF306x, MF308x

TAPE AND REEL PACKAGING (mm)

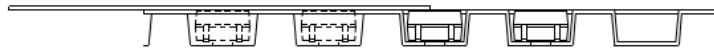
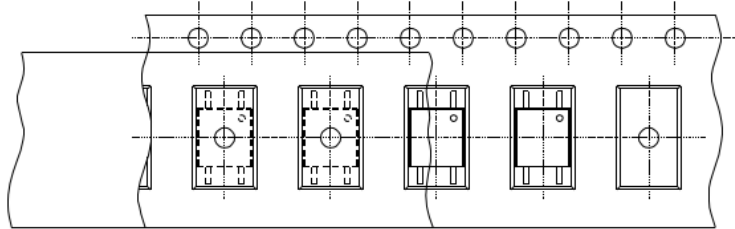

Direction of feed from reel

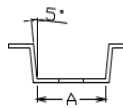
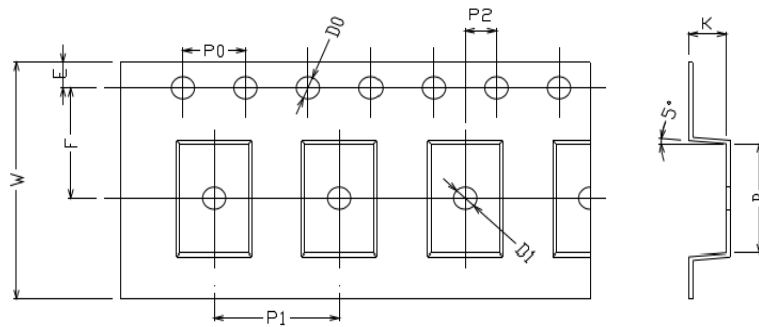
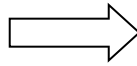

Dimension No.	A	B	Do	D1	E	F
Dimension(mm)	4.4±0.1	7.4±0.1	1.5±0.1/-0	1.5±0.1	1.75±0.1	7.5±0.1
Dimension No.	Po	P1	P2	t	W	K
Dimension (mm)	4.0±0.15	8.0±0.1	2.0±0.1	0.25±0.03	16.0±0.2	2.4±0.1



MF303x, MF304x, MF306x, MF308x

IR REFLOW SOLDERING TEMPERATURE PROFILE
(One Time Reflow Soldering is Recommended)

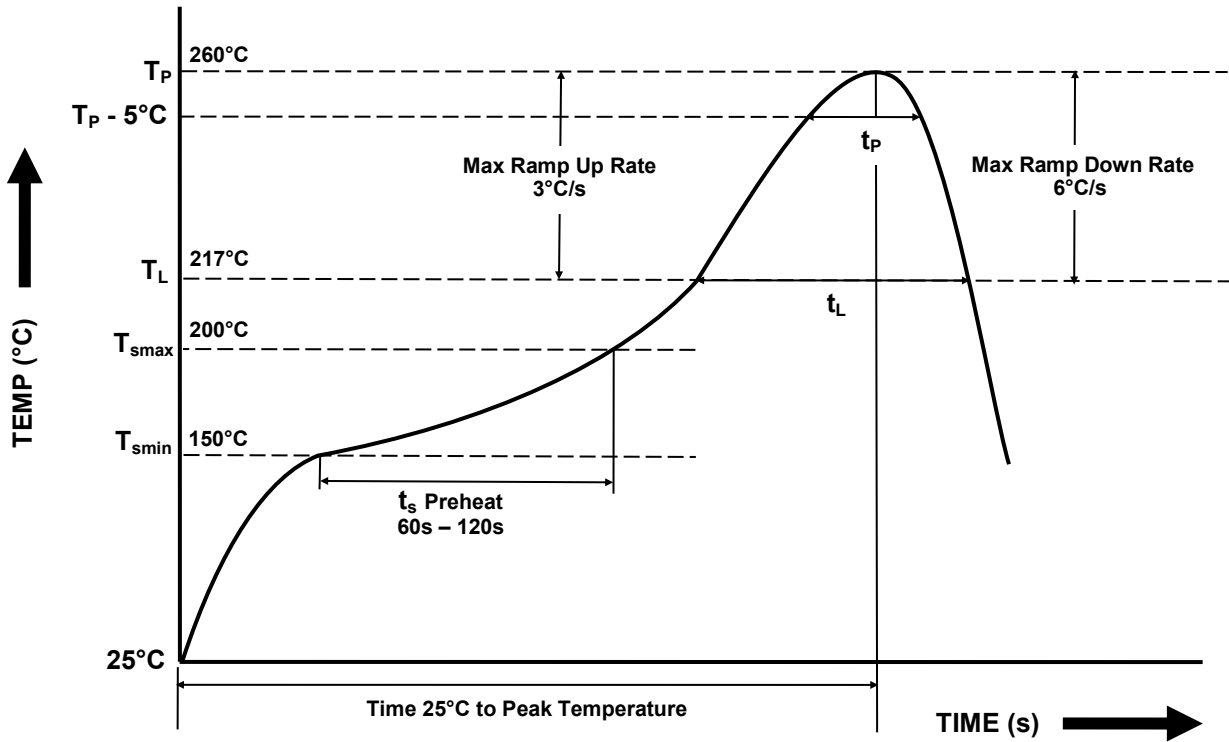

Profile Details	Conditions
Preheat - Min Temperature (T _{SMIN}) - Max Temperature (T _{SMAX}) - Time T _{SMIN} to T _{SMAX} (t _s)	150°C 200°C 60s – 120s
Soldering Zone - Peak Temperature (T _P) - Liquidous Temperature (T _L) - Time within 5°C of Actual Peak Temperature (T _P – 5°C) - Time maintained above T _L (t _L) - Ramp Up Rate (T _L to T _P) - Ramp Down Rate (T _P to T _L)	260°C 217°C 30s 60s – 100s 3°C/s max 6°C/s max
Average Ramp Up Rate (T _{smax} to T _P)	3°C/s max
Time 25°C to Peak Temperature	8 minutes max

DISCLAIMER

Isocom Components is continually working to improve the quality and reliability of its products. Nevertheless, semiconductor devices in general can malfunction or fail due to their inherent electrical sensitivity and vulnerability to physical stress. It is the responsibility of the buyer, when utilizing Isocom Components products, to comply with the standards of safety in making a safe design for the entire system, and to avoid situations in which a malfunction or failure of such Isocom Components products could cause loss of human life, bodily injury or damage to property.

In developing your designs, please ensure that Isocom Components products are used within specified operating ranges as set forth in the most recent Isocom Components products specifications.

The Isocom Components products listed in this document are intended for usage in general electronics applications (computer, personal equipment, office equipment, measuring equipment, industrial robotics, domestic appliances, etc.). These Isocom Components products are neither intended nor warranted for usage in equipment that requires extraordinarily high quality and/or reliability or a malfunction or failure of which may cause loss of human life or bodily injury ("Unintended Usage"). Unintended Usage include atomic energy control instruments, airplane or spaceship instruments, transportation Instruments, traffic signal instruments, combustion control instruments, medical Instruments, all types of safety devices, etc... Unintended Usage of Isocom Components products listed in this document shall be made at the customer's own risk.

Gallium arsenide (GaAs) is a substance used in the products described in this document. GaAs dust and fumes are toxic. Do not break, cut or pulverize the product, or use chemicals to dissolve them. When disposing of the products, follow the appropriate regulations. Do not dispose of the products with other industrial waste or with domestic garbage.

The products described in this document are subject to the foreign exchange and foreign trade laws.

The information contained herein is presented only as a guide for the applications of our products. No responsibility is assumed by Isocom Components for any infringements of intellectual property or other rights of the third parties which may result from its use. No license is granted by implication or otherwise under any intellectual property or other rights of Isocom Components or others.

The information contained herein is subject to change without notice.