



**NIKK**  
SWITCHES

# ▶ New Products



## SmartSwitch Frameless OLED Pushbutton

Full Screen, high definition programmable pushbutton switch. Features contrast and resolution of 96x64 pixels in a compact screen. Range of over 65,000 colors. Guaranteed operating life of 50,000 hours minimum. Consists of dust tight construction with low energy consumption.

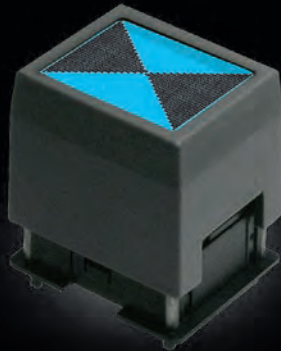

## SmartSwitch Wide View Switches

LCD 64 x 32 high resolution pushbuttons, compact pushbutton and display with larger screen, narrow frame, superior visibility. Standard pushbuttons, compact pushbuttons or display with wider view and 36 x 24 resolution.

### ▶ What is a SmartSwitch?

SmartSwitch products combine a pushbutton or rocker switch with a programmable OLED or LCD display for a space saving, simplified, multi-function device.

### ▶ Why SmartSwitch?

- Simplify complex, multi-decision operations
- Reduce panel space, installation time and cost
- Smallest off-the-shelf OLED and LCD devices



## Series KP, NP01, & UB2 with Alternating Legends

Bicolor LED illumination paired with alternating legends allows for a multitude of customized legend display options. New super bright bicolors Red/Green or Amber/Blue.



### Series M Dual Seal Waterproof Toggle

Superb quality and construction design eliminates the need for a separate waterproof boot. Dual seal provides increased protection against wet environments and debris. Polished, chrome-plated actuator delivers in terms of sleek design and functionality.



### Series SK Antistatic Snap-in Keylock

Totally sealed quality construction with internal o-ring, gasket between base and housing and insert-molded terminals provide increased protection. Housing and bushing of high insulating material withstands over 15 kilovolts of electrostatic discharge.



### Series UB Alternating Legends

Bicolors red/green and amber/blue with alternating standard or custom legends. Super bright LED provides brilliant uniform illumination. Small behind panel dimension for easy snap-in mounting in tight spaces.



### Series YB2 Panel Seal Pushbuttons

Innovative new caps with the look of classic, elegant stainless steel when nonilluminated. Features LED color or legends when illuminated. Antistatic properties with enhanced durability against environmental concerns. Meets IP65 of IEC60529 standards.

# Contents by Type

Toggles  
A  
Rocker  
B  
Pushbuttons  
C  
Illuminated PB  
D  
Programmable  
E  
Keylocks  
F  
Rotaries  
G  
Slides  
H  
Tactiles  
J  
Tilt  
K  
Touch  
L  
Indicators  
M  
Accessories  
Y  
Supplement  
Z

## Toggles

A Series . . . . .	A4
B Series . . . . .	A12
B Series Illuminated . . . . .	A20
D2 Series . . . . .	A24
G Series . . . . .	A34
G Series Illuminated . . . . .	A38
G3T Series . . . . .	A42

## Section A

M Series . . . . .	A48
M2100 Series Illuminated . . . . .	A80
M2T Series . . . . .	A88
P Series . . . . .	A96
S Series . . . . .	A100
TL Series Illuminated . . . . .	A126
WT Series . . . . .	A132

## Rockers

A Series . . . . .	B4
CW Series . . . . .	B12
CWSB Series Illuminated . . . . .	B18
CWSC Series Illuminated . . . . .	B22
G Series . . . . .	B28
GW Series . . . . .	B32
GW Series Illuminated . . . . .	B36
JW Series . . . . .	B40
JWS Series Illum & Nonillum . . . . .	B50

## Section B

LW Series Illuminated . . . . .	B56
M Series . . . . .	B62
M2100 Series Illuminated . . . . .	B92
M2T Series . . . . .	B98
MLW Series Illuminated . . . . .	B106
P Series . . . . .	B114
SW Series . . . . .	B120
WR Series . . . . .	B124

## Pushbuttons

AB Series . . . . .	C6
BB Series . . . . .	C12
DB Series . . . . .	C18
EB Series . . . . .	C24
FB Series . . . . .	C38
GB Series . . . . .	C44
GB2 Series . . . . .	C48
G3B Series . . . . .	C52
JP Series . . . . .	C58

## Section C

M2B Series . . . . .	C64
MB2000 Series . . . . .	C72
MB2400 Series . . . . .	C96
MB2500 Series . . . . .	C116
SB Series . . . . .	C128
SB4011 Series . . . . .	C38
SCB Series . . . . .	C131
WB Series . . . . .	C134

## Illuminated Pushbuttons

FP01 Series . . . . .	D4
GB Series . . . . .	D8
HB Series Illum & Nonillum . . . . .	D12
HB2 Series . . . . .	D18
KB Series Illum & Nonillum . . . . .	D22
KP Series . . . . .	D36
LB Series Illum & Nonillum . . . . .	D48

## Section D

LP01 Series Illum & Nonillum . . . . .	D68
NP01 Series Illum & Nonillum . . . . .	D74
UB Series Illum & Nonillum . . . . .	D80
UB2 Series Illum & Nonillum . . . . .	D92
YB Series Illum & Nonillum . . . . .	D104
YB2 Series Illum & Nonillum . . . . .	D118

## SmartSwitch Programmable Switches & Displays

Frameless OLED Pushbutton . . . . .	E4
OLED Pushbutton . . . . .	E8
OLED Display . . . . .	E8
OLED Rocker . . . . .	E15
LCD 64 x 32 Pushbutton . . . . .	E22
LCD 64 x 32 Display . . . . .	E26

## Section E

LCD 64 x 32 Compact Pushbutton . . . . .	E28
LCD 36 x 24 Pushbutton . . . . .	E35
LCD 36 x 24 Display . . . . .	E39
LCD 36 x 24 Compact Pushbutton . . . . .	E41
Accessories . . . . .	E48

# Contents by Type

## Keylocks

CK Series High Security . . . . .	F3
SK Series Low, Medium Security . . .	F9
SK Series Antistatic, PCB Mount . .	F15

## Section F

SK Series Process Sealed, PCB . . .	F19
SK Series Antistatic, Snap-in . . . .	F25

A  
Toggles

B  
Rockers

C  
Pushbuttons

D  
Illuminated PB

E  
Programmable

F  
Keylocks

G  
Rotaries

H  
Slides

J  
Tactiles

K  
Tilt

L  
Touch

M  
Indicators

Y  
Accessories

Z  
Supplement

## Rotaries

FRO1 Series . . . . .	G4
FRO2 Series . . . . .	G12
HS Series . . . . .	G46
MR Series Logic Level . . . . .	G16
MR Series Power Level . . . . .	G22

## Section G

MRB Series . . . . .	G28
ND Series . . . . .	G34
ND3 Series . . . . .	G38
PS Series . . . . .	G46
TS Series . . . . .	G46

## Slides

AS Series . . . . .	H4
CS Series . . . . .	H10
FS Series . . . . .	H14
JSO1 & JSO3 Series . . . . .	H18
JSO2 & JSO4 Series . . . . .	H24
MS Series . . . . .	H30

## Section H

MS Series Illuminated. . . . .	H38
SM Series . . . . .	H42
SS Series. . . . .	H44
SS Series Illuminated. . . . .	H49
SS3 Series . . . . .	H53

## Tactiles

CB Series . . . . .	J4
CB3 Series . . . . .	J8
HPO2 Series . . . . .	J12
HPO3 Series . . . . .	J16
JB Series . . . . .	J20

## Section J

JB Series Illuminated . . . . .	J28
JF Series . . . . .	J34
JF Series Illuminated . . . . .	J40
JL Series Illuminated . . . . .	J46

## Tilt Switches

DSA Series . . . . .	K3
----------------------	----

## Section K

DSB Series . . . . .	K3
----------------------	----

## Touch Screens & Membranes

FT Series Touch Screens . . . . .	L3
-----------------------------------	----

## Section L

FM Series Membranes . . . . .	L15
-------------------------------	-----

## Indicators

Matching Indicators for Series: A, G, HB, JF, KB, LB, PO1 (MLW), UB, UB2, YB . . .	M2
--	----

## Section M

## Accessories & Hardware

Adaptors, Bezels, Boots, Caps, Hardware, Keys, Knobs, Lamps, Mounters, O-rings, Paddles, Protective Covers & Guards, Rockers, Sockets, Tools . . . . .	Y1 - Y34
--	----------

## Section Y

## Supplement

Product Safety Precautions, In-House Standard Test Methods, General Tolerances, Materials & Conversions, Electrical Ratings, Lamps & LEDs, Ballast Resistors, Processing Data, Standards & Approvals, Terms & Acronyms . . . . .	Z1 - Z27
Product Overview . . . . .	Z28 - Z29
Index by Model No. . . . .	Z30 - Z33

## Section Z

# Contents by Series

Series	Description	Section/Page	Series	Description	Section/Page
<b>A</b>	Subminiature/Toggle/Process Seal	A4	<b>G</b>	Ultra-miniature/Illum Toggle/Process Seal/PC Mnt	A38
<b>A</b>	Subminiature/Rocker/Process Seal	B4	<b>G</b>	Ultra-miniature/Rocker/Process Seal/PC Mount	B28
<b>A</b>	Subminiature/Indicator/PC Mount	M3	<b>G</b>	Ultra-miniature/Indicator/PC Mount	M5
<b>AB</b>	Subminiature/Pushbutton/Process Seal	C6	<b>GB</b>	Ultra-miniature/Pushbutton/Process Seal/PC Mnt	C44
<b>AS</b>	Subminiature/Slide/PC Mount	H4	<b>GB</b>	Ultra-miniature/Illum Plunger/Process Seal/PC Mnt	D8
<b>AT</b>	Accessories & Hardware	Y2	<b>GB2</b>	Ultra-thin/Pushbutton/PC Mount	C48
<b>B</b>	Subminiature/Toggle/Antistatic/Process Seal	A12	<b>G3B</b>	Ultra-miniature/Process Seal Pushbutton/SMT	C52
<b>B</b>	Subminiature/Fully Illuminated Toggle/Process Seal	A20	<b>G3T</b>	Ultra-miniature/Process Seal Toggle/SMT	A42
<b>BB</b>	Subminiature/Pushbutton/Antistatic/Process Seal	C12	<b>GW</b>	Ultra-thin/Rocker/PC Mount	B32
<b>CB</b>	6mm/Process Seal Tactile/Through-Hole Mount	J4	<b>GW</b>	Ultra-thin/Fully Illuminated Paddle/PC Mount	B36
<b>CB3</b>	6mm/Process Seal Tactile/SMT	J8	<b>HB</b>	Subminiature/Illum & Nonillum PB/Panel Mount	D12
<b>CK</b>	16 & 19mm Hi Security Keylock/Bushing Mount	F3	<b>HB</b>	Subminiature/Indicator/Panel Mount	M6
<b>CS</b>	Miniature/Slide/Antistatic/PC Mount	H10	<b>HB2</b>	Subminiature/Audio-Video Pushbutton/PC Mount	D18
<b>CW</b>	Miniature/Power Rocker/Snap-in/Panel Mount	B12	<b>HP02</b>	6mm Tactile/Through-hole Mount	J12
<b>CWSB</b>	Miniature/Power Rocker/Neon Lighted	B18	<b>HP03</b>	6mm Tactile/SMT	J16
<b>CWSC</b>	Miniature/Power Rocker/LED Lighted	B22	<b>HS</b>	Standard Size/Rotary/6 & 12 amp/1-6 Pole	G46
<b>D2</b>	Miniature/Toggle/Light Duty	A24	<b>IS</b>	Programmable/Frameless OLED Pushbutton/96 x 64	E4
<b>DB</b>	Miniature/Pushbutton/Light Touch	C18	<b>IS</b>	Programmable/OLED Pushbutton/64 x 48	E8
<b>DSA</b>	Mercury-free/Sealed/Tilt Switch	K3	<b>IS</b>	Programmable/OLED Display/52 x 36	E8
<b>DSB</b>	Contactless/Photo Interrupter/Sealed/Tilt Switch	K3	<b>IS</b>	Programmable/OLED Rocker/96 x 64	E15
<b>EB</b>	Miniature/Light Touch Pushbutton/Panel Mount	C24	<b>IS</b>	Programmable/Pushbutton/LCD 64 x 32	E22
<b>EB</b>	Miniature/Light Touch Pushbutton/Snap-in Mount	C30	<b>IS</b>	Programmable/Display/LCD 64 x 32	E26
<b>FB</b>	Subminiature/Pushbutton/Panel Mount	C38	<b>IS</b>	Programmable/Compact Pushbutton/LCD 64 x 32	E28
<b>FM</b>	Illum, 12 or 16 Keys/Nonillum, 4 or 16/Membrane	L15	<b>IS</b>	Programmable/Pushbutton/LCD 36 x 24	E35
<b>FP01</b>	Contactless/Illuminated Pushbutton/Snap-in Mount	D4	<b>IS</b>	Programmable/Display/LCD 36 x 24	E39
<b>FR01</b>	10mm Ultra-Thin/DIP Rotary/Through-hole	G4	<b>IS</b>	Programmable/Compact Pushbutton/LCD 36 x 24	E43
<b>FR02</b>	10mm Ultra-Thin/DIP Rotary/SMT	G12	<b>JB</b>	Low Profile/Tactile/Process Seal	J20
<b>FS</b>	Miniature/Slide/High Frequency/PC Mount	H14	<b>JB</b>	Low Profile/Illuminated Tactile/Process Seal	J28
<b>FT</b>	Resistive/5-Wire, 4-Wire & Digital/Touch Screen	L3	<b>JF</b>	Ultra-thin/Tactile/Process Seal	J34
<b>G</b>	Ultra-miniature/Toggle/Process Seal/PC Mount	A34	<b>JF</b>	Ultra-thin/Illuminated Tactile/Process Seal	J40
			<b>JF</b>	Ultra-thin/Indicator/Process Seal	M8
			<b>JL</b>	Ultra-thin/Illuminated Tactile/PC Mount	J46
			<b>JP</b>	TV Rated/Pushbutton/Snap-in Mount	C58
			<b>JS01</b>	DIP Slide/Through-hole/Standard Actuator	H18
			<b>JS02</b>	DIP Slide/SMT/Standard Actuator	H24
			<b>JS03</b>	DIP Slide/Through-hole/Piano Actuator	H18
			<b>JS04</b>	DIP Slide/SMT/Piano Actuator	H24

# Contents by Series

Series	Description	Section/Page	Series	Description	Section/Page
<b>JWL</b>	TV Rated/16 Amp Rocker/Snap-in Mount	B40	<b>P01</b>	Miniature/Indicator/for MLW Series	M19
<b>JWM</b>	TV Rated/10 Amp Rocker/Snap-in Mount	B40	<b>PS</b>	Standard Size/Rotary/30 Amp/1-5 Pole	G46
<b>JWS</b>	10 Amp Rocker/Snap-in Mount	B50	<b>S</b>	Standard Size/Toggle/Low Capacity	A101
<b>KB</b>	Miniature/Illum, Nonillum Pushbutton/Panel Mount	D22	<b>S</b>	Standard Size/Toggle/Medium Capacity	A103
<b>KB</b>	Miniature/Indicator/Panel Mount	M9	<b>S</b>	Standard Size/Toggle/Medium-High Capacity	A108
<b>KP</b>	Illuminated Audio-Video Pushbutton	D36	<b>S</b>	Standard Size/Toggle/High Capacity	A119
<b>LB</b>	Standard Size/Illum, Nonillum PB/Panel Mount	D48	<b>SB</b>	Standard Size/Pushbutton/Low-Medium Capacity	C128
<b>LB</b>	Standard Size/Illum, Nonillum PB/Panel Seal	D59	<b>SB40</b>	Miniature/Pushbutton/Panel Mount	C38
<b>LB</b>	Standard Size/Indicator/Panel Mount	M14	<b>SCB</b>	Standard Size/Pushbutton/Snap Action	C131
<b>LP01</b>	Short Body/Illum, Nonillum PB/Panel Mount	D68	<b>SK</b>	12mm Low & Med Security Keylock/Bushing Mnt	F9
<b>LW</b>	Standard Size/Dual Lamp Rocker/Power Rated	B56	<b>SK</b>	Subminiature Keylock/Antistatic/Process Seal	F15
<b>LW</b>	Standard Size/Illuminated Rocker/Hi Capacity	B61	<b>SK</b>	Miniature Keylock/Process Seal	F19
<b>M</b>	Miniature/Toggle/Multi-function	A48	<b>SK</b>	Miniature Keylock/Antistatic/Snap-in/Custom	F25
<b>M</b>	Miniature/Rocker & Paddle/Multi-function	B62	<b>SM</b>	Ultra-miniature/Slide/PC Mount	H42
<b>M2B</b>	Miniature/Pushbutton/Process Seal	C64	<b>SS</b>	Ultra-miniature/Slide/PC Mount	H44
<b>M2T</b>	Miniature/Toggle/Process Seal	A88	<b>SS</b>	Ultra-miniature/Illuminated Slide/PC Mount	H49
<b>M2T</b>	Miniature/Rocker & Paddle/Process Seal	B98	<b>SS3</b>	Ultra-miniature/Slide/SMT	H53
<b>M2100</b>	Miniature/LED Tip Toggle	A80	<b>SW</b>	Standard Size/Rockers/Medium Capacity	B120
<b>M2100</b>	Miniature/LED Tip Rocker & Paddle	B92	<b>SW</b>	Standard Size/Rockers/High Capacity	B122
<b>MB2000</b>	Miniature/Pushbutton/Momentary & Alternate Action	C72	<b>TL</b>	Miniature/Illuminated Toggle/Panel Mount	A126
<b>MB2400</b>	Miniature/Pushbutton/Light Touch/Momentary	C96	<b>TS</b>	Standard Size/Rotary/6 Amp/1-5 Pole	G46
<b>MB2500</b>	Miniature/Pushbutton/Light Touch/Momentary	C116	<b>UB</b>	Low Profile/Illum, Nonillum PB/PC & Snap-in	D80
<b>MLW</b>	Miniature/Illuminated Rocker, Paddle/Power Rated	B106	<b>UB</b>	Low Profile/Indicator/PC & Snap-in	M21
<b>MR</b>	Rotary/Logic Level/1/2" Diameter/Process Seal	G16	<b>UB2</b>	Low Profile/Illum, Nonillum PB/PC & Snap-in	D92
<b>MR</b>	Rotary/Power Level/1/2" Diameter/Enclosed	G22	<b>UB2</b>	Low Profile/Indicator/PC & Snap-in	M26
<b>MRB</b>	Rotary/Process Seal/Logic Level/PC Mount	G28	<b>WB</b>	Std Size/Pushbutton/Environmentally Sealed	C134
<b>MS</b>	Miniature/Slide/Power & Logic Level	H30	<b>WR</b>	Standard Size/Rocker/Environmentally Sealed	B124
<b>MS</b>	Miniature/Illuminated Slide/Power Level	H38	<b>WT</b>	Standard Size/Toggle/Environmentally Sealed	A132
<b>ND</b>	8mm DIP Rotary/Process Seal/Binary Coded	G34	<b>YB</b>	Short Body/Illum, Nonillum PB/Panel Mount	D104
<b>ND3</b>	8mm DIP Rotary/SMT/Binary Coded	G38	<b>YB</b>	Short Body/Indicator/Panel Mount	M29
<b>NP01</b>	Submini/Illumin PB/Smooth Actuation/PC Mount	D74	<b>YB2</b>	22mm/Short Body/Illuminated PB/Panel Mount	D118
<b>P</b>	Standard Size/Toggle/Panel Mount	A96			
<b>P</b>	Standard Size/Rocker & Paddle/Panel Mount	B114			

# Switch Selection Guide

## TOGGLES - SECTION A

MAXIMUM RATING	SIZE	MOUNTING					TERMINALS					PROCESS SEAL	SERIES	PAGE NO.
		PC Board	Bush-ing	Snap-in	Two Screw	Solder Lug	PC	Quick Connect	Wire-Wrap	Screw	SMT Gull Wing			
0.4VA @ 28V AC/DC	ultra-mini	•					•					•	G	A34
0.4VA @ 28V AC/DC	ultra-mini	•					•					•	G Illum	A38
0.4VA @ 28V AC/DC	ultra-mini										•	•	G3T	A42
0.4VA @ 28V AC/DC	submini	•					•					•	A	A4
0.4VA @ 28V AC/DC	submini	•					•					•	B	A12
0.4VA @ 28V AC/DC	submini	•					•					•	B Illum	A20
0.4VA @ 28V AC/DC	miniature	•	•			•	•	•	•			•	M	A48
0.4VA @ 28V AC/DC	miniature	•				•	•					•	M2T	A88
0.4VA @ 28V AC/DC	miniature	•	•			•	•	•					M2100	A80
0.4VA @ 28V AC/DC	miniature		•			•							TL	A126
0.4VA @ 48V AC/DC	miniature	•	•			•							D2	A24
6A @ 125V AC	miniature	•	•			•	•	•	•				M	A48
6A @ 125V AC	miniature	•				•						•	M2T	A88
6A @ 125V AC	miniature	•	•			•	•	•					M2100	A80
6A @ 125V AC	miniature		•			•							TL	A126
10A @ 125V AC	standard	•	•			•	•	•					P	A96
10A @ 125V AC	standard		•			•			wire lead	•			WT	A132
5A @ 125V AC	standard		•			•							S Low Cap	A101
15~20A @ 125V AC	standard		•			•		•					S Med Cap	A103
15~25A @ 125V AC	standard		•			•		•			•		S Med/Hi	A108
30~50A @ 125V AC	standard		•								•		S Hi Cap	A119
30A @ 125V AC/DC	standard		•								•		S AC/DC	A119

## ROCKERS - SECTION B

MAXIMUM RATING	SIZE	MOUNTING					TERMINALS					PROCESS SEAL	SERIES	PAGE NO.
		PC Board	Bush-ing	Snap-in	Two Screw	Solder Lug	PC	Quick Connect	Wire-Wrap	Screw				
0.4VA @ 28V AC/DC	ultra-mini	•					•					•	G	B28
0.4VA @ 28V AC/DC	ultra-mini	•					•						GW	B32
0.4VA @ 28V AC/DC	ultra-mini	•					•						GW Illum	B36
0.4VA @ 28V AC/DC	submini	•					•					•	A	B4
0.4VA @ 28V AC/DC	miniature	•		•	•	•	•	•	•				M	B62
0.4VA @ 28V AC/DC	miniature	•				•	•					•	M2T	B98
0.4VA @ 28V AC/DC	miniature	•		•	•	•	•	•					M2100	B92
3A @ 250V AC	miniature			•		•							CWT	B12
5A @ 125V AC	miniature			•		•							MLW	B106
6A @ 125V AC	miniature			•		•							CWT	B12
6A @ 125V AC	miniature	•		•	•	•	•	•	•				M	B62
6A @ 125V AC	miniature	•				•						•	M2T	B98
6A @ 125V AC	miniature	•		•	•	•	•	•					M2100	B92
6A @ 125/250V AC	miniature			•		•		•					JWS	B50
6A @ 250V AC	miniature	•		•		•		•					CWS	B12
9A @ 125V AC	miniature			•		•		•					CWSB Illum	B18
9A @ 125V AC	miniature			•		•		•					CWSC Illum	B22
10A @ 125V AC	standard			•	•	•	•	•					P	B114
10A @ 125V AC	standard			•		•							LW	B56
10A @ 125/250V AC	miniature			•		•		•					JWS	B50
10A @ 125/250V AC	standard			•		•		•					JWM	B40
15A @ 125/250V AC	standard			•		•		•	wire lead	•			WR	B124
16A @ 125/250V AC	standard			•		•		•					JWL	B40
20A @ 110V AC	standard				•	•							LW	B56
15~20A @ 125V AC	standard				•	•							SW Med	B120
30A @ 125V AC/DC	standard				•	•					•		SW Hi Cap	B122



# Switch Selection Guide

## PUSHBUTTONS - SECTION C

MAXIMUM RATING	SIZE	MOUNTING					TERMINALS					PROCESS SEAL	SERIES	PAGE NO.
		PC Board	Bush-ing	Snap-in	Two Screw	Solder Lug	PC	Quick Connect	Wire-Wrap	Screw	SMT Gull Wing			
0.4VA @ 28V AC/DC	ultra-mini	•					•					•	GB	C44
0.4VA @ 28V AC/DC	ultra-mini	•					•						GB2	C48
0.4VA @ 28V AC/DC	ultra-mini										•	•	G3B	C52
0.4VA @ 28V AC/DC	submini	•					•					•	AB	C6
0.4VA @ 28V AC/DC	submini	•					•					•	BB	C12
0.4VA @ 28V AC/DC	miniature	•	•				•						DB	C18
0.4VA @ 28V AC/DC	miniature	•	•	•		•	•						EB	C24
0.4VA @ 28V AC/DC	submini		•				turret						FB	C38
0.4VA @ 28V AC/DC	miniature	•					•					•	M2B	C64
0.4VA @ 28V AC/DC	miniature	•	•	•		•	•	•	•				MB2000	C72
0.4VA @ 28V AC/DC	miniature	•	•	•		•	•	•	•				MB2400	C96
0.4VA @ 28V AC/DC	miniature	•	•	•		•	•						MB2500	C116
0.4VA @ 28V AC/DC	miniature		•			•							SB4011	C38
500mA @ 125V AC	submini		•				turret						FB	C38
1A @ 125V AC	miniature	•					•					•	M2B	C64
3A @ 125V AC	miniature	•	•	•		•	•						EB	C24
3A @ 125V AC	miniature	•	•	•		•	•		•				MB2400	C96
3A @ 125V AC	miniature	•	•	•		•	•						MB2500	C116
3A @ 125V AC	miniature		•			•							SB4011	C38
6A @ 125V AC	miniature	•	•	•		•	•	•	•				MB2000	C72
6A @ 125V AC	standard		•			•			wire lead	•			WB	C134
10A @ 125/250V AC	standard			•		•		•					JPM	C58
15A @ 125V AC	standard		•			•				•			SB	C128
15A @ 125V AC	standard		•					•					SCB	C131
16A @ 125/250V AC	standard			•		•		•					JPL	C58

## ILLUMINATED PUSHBUTTONS - SECTION D

MAXIMUM RATING	SIZE	MOUNTING					TERMINALS					PROCESS SEAL	SERIES	PAGE NO.
		PC Board	Bush-ing	Snap-in	Two Screw	Solder Lug	PC	Quick Connect	Wire-Wrap	Screw				
0.4VA @ 28V AC/DC	ultra-mini	•					•						GB	D8
0.4VA @ 28V AC/DC	submini	•					•						HB2	D18
0.4VA @ 28V AC/DC	submini	•					•						NP01	D74
0.4VA @ 28V AC/DC	miniature	•	•	•		•	•						KB	D22
0.4VA @ 28V AC/DC	miniature	•		•		•	•						UB	D80
0.4VA @ 28V AC/DC	miniature	•		•		•	•						UB2	D92
0.4VA @ 28V AC/DC	miniature		•	•		•	•	•					YB	D104
0.4VA @ 28V AC/DC	standard	•	•	•		•	•	•					LB	D48
0.4VA @ 28V AC/DC	standard		•			•		•				•	YB2	D118
0.1A @ 30V AC/DC	submini		•			•							HB	D12
100mA @ 12V DC	miniature	•					•						KP	D36
1A @ 125/250V AC	miniature	•	•	•		•	•						KB	D22
3A @ 125/250V AC	miniature		•	•		•	•	•					YB	D104
3A @ 125/250V AC	miniature		•	•		•	•	•					LP01	D68
3A @ 125/250V AC	standard	•	•	•		•	•	•					LB	D48
3A @ 125/250V AC	standard		•			•		•				•	YB2	D118
5A @ 125/250V AC	miniature	•		•		•	•						UB	D80
5A @ 125/250V AC	miniature	•		•		•	•						UB2	D92
5V Photo Interrupter	standard			•									* FP01	D4

\* See FP01 Series for connector options

# Switch Selection Guide

## SMARTSWITCH PROGRAMMABLE - SECTION E

MAXIMUM RATING	SIZE	LCD	OLED	RESOLUTION (PIXELS)	MOUNTING		TERMINALS	SERIES	PAGE NO.
					PC Board	Snap-in	PC		
<b>PUSHBUTTON</b>									
100mA @ 12V DC	standard		•	96 x 64	•		•	IS	E4
100mA @ 12V DC	standard		•	64 x 48	•		•	IS	E8
100mA @ 12V DC	standard	•		64 x 32	•		•	IS	E22
100mA @ 12V DC	compact	•		64 x 32	•		•	IS	E28
100mA @ 12V DC	standard	•		36 x 24	•	* •	•	IS	E35
100mA @ 12V DC	compact	•		36 x 24	•		•	IS	E41
<b>DISPLAY</b>									
	standard		•	52 x 36				IS	E8
	standard	•		64 x 32				IS	E26
	standard	•		36 x 24				IS	E39
<b>ROCKER</b>									
3VA maximum DC			•	96 x 64			•	IS	E15

\* Mounting option with Panel Mount Housing

## KEYLOCKS - SECTION F

MAXIMUM RATING	SIZE	MOUNTING	INDEXING	TERMINALS	POSITIONS	PROCESS SEAL	SERIES	PAGE NO.
0.4VA @ 28V AC/DC	submini	PC Board	45°	PC	3	•	SK	F15
0.4VA @ 28V AC/DC	submini	PC Board	45°	PC	5	•	SK	F15
0.4VA @ 28V AC/DC	miniature	PC Board	90°	PC	2	•	SK	F19
0.4VA @ 28V AC/DC	miniature	PC Board	45°	PC	3	•	SK	F19
0.4VA @ 28V AC/DC	miniature	Snap-in	45°	Solder Lug	3		SK	F25
3A @ 125V AC	miniature	Bushing	45°	Solder Lug	3		SK	F9
3A @ 125V AC	miniature	Bushing	90°	Solder Lug	2		SK	F9
3A @ 250V AC	standard	Bushing	90°	Solder Lug	2		CK	F3
3A @ 250V AC	standard	Bushing	45°	Solder Lug	3		CK	F3

## ROTARIES - SECTION G

MAXIMUM RATING	SIZE	MOUNTING		INDEXING Step Size	TERMINALS				PROCESS SEAL	SERIES	PAGE NO.
		PC Board	Bush-ing		Solder Lug	PC	Screw	SMT Gull Wing			
0.4VA @ 28V AC/DC	miniature	•		30°		•			•	MRF	G16
0.4VA @ 28V AC/DC	miniature	•	•	30°		•			•	MRK	G16
0.4VA @ 28V AC/DC	miniature	•	•	45° & 90°		•			•	MRB	G28
0.4VA @ 28V AC/DC	miniature		•	60°		turret				MRY	G22
100mA @ 5/50V DC	ultra-mini	•		22.5° & 36°		•			•	ND	G34
100mA @ 5/50V DC	ultra-mini			22.5° & 36°				•	•	ND3	G38
100mA @ 5/50V DC	submini	•	•	22.5° & 36°		•				FR01	G4
100mA @ 5/50V DC	submini			22.5° & 36°				•		FR02	G12
250mA @ 125V AC	miniature	•	•	30°		•			•	MRA	G16
1A @ 30V DC	miniature		•	45°		turret				MRX	G22
2A @ 30V DC	miniature		•	60°		turret				MRY	G22
2A @ 125V AC	miniature		•	45°		turret				MRX	G22
3A @ 30V DC	miniature		•	60°	•					MRT23	G22
3A @ 125V AC	miniature		•	60°		turret				MRY	G22
4A @ 30V DC	miniature		•	120°	•					MRT22	G22
5A @ 125V AC	miniature		•	60°	•					MRT23	G22
6A @ 125V AC	standard		•	45°	•					HS13	G46
6A @ 125/250V AC	standard		•	30°				•		TS	G46
10A @ 125V AC	miniature		•	120°	•					MRT22	G22
12A @ 125V AC	standard		•	30°	•					HS16	G46
30A @ 125/250V AC	standard		•	30°				•		PS	G46

# Switch Selection Guide

## SLIDES - SECTION H

MAXIMUM RATING	SIZE	MOUNTING					TERMINALS					PROCESS SEAL	SERIES	PAGE NO.	
		PC Board	Bush-ing	Snap-in	Two Screw	Solder Lug	PC	Quick Connect	Wire-Wrap	Screw	SMT Gull Wing				
0.4VA @ 28V AC/DC	ultra-mini	•					•							SS	H44
0.4VA @ 28V AC/DC	ultra-mini											•		SS3	H53
0.4VA @ 28V AC/DC	submini	•					•							AS	H4
0.4VA @ 28V AC/DC	miniature	•					•							FS	H14
0.4VA @ 28V AC/DC	miniature	•			•	•	•							MS	H30
1.0mA @ 10mV AC/DC	ultra-mini	•					•							SM	H42
25mA @ 24V DC	ultra-mini	•					•							JS01, JS03	H18
25mA @ 24V DC	ultra-mini											•		JS02, JS04	H24
0.1A @ 12V DC	ultra-mini											•		SS3	H53
0.1A @ 30V DC	ultra-mini	•					•							SS	H44
0.1A @ 30V DC	ultra-mini	•					•							SS Illum	H49
0.1A @ 50V DC	ultra-mini	•					•							JS01, JS03	H18
0.1A @ 50V DC	ultra-mini											•		JS02, JS04	H24
500mA @ 12V DC	ultra-mini	•					•							SM	H42
3A @ 125V AC	miniature	•					•							CS	H10
6A @ 125V AC	miniature	•			•	•	•							MS	H30
6A @ 125V AC	miniature	•			•	•	•							MS Illum	H38

## TACTILES - SECTION J

MAXIMUM RATING	SIZE	MOUNTING					TERMINALS					PROCESS SEAL	SERIES	PAGE NO.	
		PC Board	Bush-ing	Snap-in	Two Screw	Solder Lug	PC	Quick Connect	Wire-Wrap	Screw	SMT Gull Wing				
0.4VA @ 28V AC/DC	ultra-mini	•					•							HP02	J12
0.4VA @ 28V AC/DC	ultra-mini											•		HP03	J16
3VA @ 28V DC	ultra-mini	•					•							HP02	J12
3VA @ 28V DC	ultra-mini											•		HP03	J16
50mA @ 24V DC	ultra-mini	•					•						•	CB	J4
50mA @ 24V DC	ultra-mini											•	•	CB3	J8
50mA @ 24V DC	submini	•					•						•	JF	J34
50mA @ 24V DC	submini	•					•							JF Illum	J40
50mA @ 24V DC	submini	•					•						•	JB	J20
50mA @ 24V DC	submini	•					•						•	JB Illum	J28
50mA @ 24V DC	submini	•					•							JL	J46
125mA @ 24V DC	submini	•					•						•	JB	J20
125mA @ 24V DC	submini	•					•						•	JB Illum	J28

## TILT SWITCHES - SECTION K

MAXIMUM RATING	SIZE	MOUNTING				TERMINALS				PROCESS SEAL	SERIES	PAGE NO.		
		PC Board	Bush-ing	Snap-in	Two Screw	Solder Lug	PC	Quick Connect	Wire-Wrap				Screw	
0.1A @ 12V DC	miniature	•					•						DSA	K3
5V Photo Interrupter	submini	•					•					•	DSB	K3

# Switch Selection Guide

## TOUCH SCREENS - SECTION L

MAXIMUM RATING	TECHNOLOGY	INPUT METHOD	* STANDARD SCREEN SIZES	SERIES	PAGE NO.
5.5V DC	5-Wire Resistive	Finger, Gloved Finger or Stylus	10.4" ~ 15.0"	FT	L3
1mA @ 5V DC (resistive load)	4-Wire Resistive		5.7" ~ 15.0"	FT	L8
	Digital	Finger	5.7"	FT	L14

\* Custom sizes available; contact factory for more information.

## MEMBRANE SWITCH KEYPADS - SECTION L

MAXIMUM RATING	ILLUMINATION	NUMBER OF KEYS	SURFACE SHEET		Overlay	SERIES	PAGE NO.
			Black	Gray			
20mA @ 24V DC	Nonilluminated	4	•			FM	L15
		4		•			
		16	•				
		16		•			
	Dot Illuminated with Overlay	12			Gray Surface Sheet with Embossed White Keypad & Gray Legends		
		16					





## A Series.....A4

0.4VA Logic Level; Process Sealed  
Straight, Right Angle, & Vertical PC  
PCB Mount



## B Series.....A12

Antistatic; Process Sealed  
0.4VA Logic Level  
Straight, Right Angle, & Vertical PC  
PCB Mount



## B Series Illuminated.....A20

Subminiature Fully Illuminated; Process Sealed  
0.4VA Logic Level  
Straight, Right Angle, & Vertical PC  
PCB Mount



## D2 Series.....A24

0.4VA Logic Level  
Straight, Right Angle, & Vertical PC  
PCB Mount



## G Series.....A34

Ultra-Miniature; Process Sealed  
0.4VA Logic Level  
Straight, Right Angle, & Vertical PC  
PCB Mount



## G Series Illuminated.....A38

Ultra-Miniature Fully Illuminated  
0.4VA Logic Level  
Straight, Right Angle, & Vertical PC  
PCB Mount



## G3T Series.....A42

Ultra-Miniature; Process Sealed SMT  
0.4VA Logic Level  
Gull-wing Terminals  
Upright & Right Angle Mount



## M Series.....A48

Dual Seal Waterproof, IP67 Rated  
6A Power Level & 0.4VA Logic Level  
12mm Bushing, Solder Lug Terminals



## M Series.....A52

Bushing Mount  
6A Power Level & 0.4VA Logic Level  
Solder Lug, Quick Connect, Straight PC, & Wirewrap



**M Series** .....A64  
 Straight PC with Bracket  
 6A Power Level & 0.4VA Logic Level  
 PCB Mount



**M Series** .....A70  
 Right Angle & Vertical PC  
 6A Power Level & 0.4VA Logic Level  
 PCB Mount



**M2100 Series Illuminated** .....A80  
 6A Power Level & 0.4VA Logic Level  
 LED Tipped Toggle  
 Solder Lug, Quick Connect, & PC  
 Bushing, Flat Frame & Snap-in Mount



**M2T Series** .....A88  
 Process Sealed  
 6A Power Level & 0.4VA Logic Level  
 Straight, Right Angle, Vertical, & Extended PC  
 PCB Mount



**P Series** .....A96  
 Internationally Approved  
 10A Power Level  
 Solder Lug, Straight PC, & Quick Connect  
 Bushing Mount



**S Series** .....A100  
 5A to 50A Low, Medium, & High Capacity  
 Solder Lug, Quick Connect, & Screw Lug  
 Bushing Mount



**TL Series Illuminated** .....A126  
 6A Power Level or 0.4VA Logic Level  
 Translucent Toggle with Bright or Super Bright LED  
 Solder Lug; Bushing Mount



**WT Series** .....A132  
 Environmentally Sealed  
 10A Power Level  
 Solder Lug, Screw Lug, & Wire Lead  
 Bushing Mount

A	Toggles
	Rockers
	Pushbuttons
	Illuminated PB
	Programmable
	Keylocks
	Rotaries
	Slides
	Tactiles
	Tilt
	Touch
	Indicators
	Accessories
	Supplement

## General Specifications

**Electrical Capacity (Resistive Load)**

**Logic Level:** 0.4VA maximum @ 28V AC/DC maximum  
(Applicable Range 0.1mA ~ 0.1A @ 20mV ~ 28V)  
Note: Find additional explanation of operating range in Supplement section.

**Other Ratings**

**Contact Resistance:** 50 milliohms maximum  
**Insulation Resistance:** 500 megohms minimum @ 500V DC  
**Dielectric Strength:** 500V AC minimum between contacts for 1 minute minimum;  
500V AC minimum between contacts & case for 1 minute minimum  
**Mechanical Life:** 100,000 operations minimum for On-None-On & On-Off-On  
50,000 operations minimum for other circuits  
**Electrical Life:** 50,000 operations minimum  
**Nominal Operating Force:** 1.47N (momentary); 1.18N (maintained) for .394" (10.0mm) toggles  
2.73N (momentary); 1.84N (maintained) for all other toggles  
**Contact Timing:** Nonshorting (break-before-make)  
**Angle of Throw:** 26°

**Materials & Finishes**

**Toggle:** Glass fiber reinforced polyamide for antistatic; nickel plated brass for all others  
**Case Housing:** Glass fiber reinforced polyamide  
**Support Bracket:** Tin plated phosphor bronze  
**Movable Contact:** Phosphor bronze with gold plating  
**Stationary Contacts:** Brass with gold plating  
**Terminals:** Brass with gold plating

**Environmental Data**

**Operating Temperature Range:** -30°C through +85°C (-22°F through +185°F)  
**Humidity:** 90 ~ 95% humidity for 240 hours @ 40°C (104°F)  
**Vibration:** 10 ~ 55Hz with peak-to-peak amplitude of 1.5mm traversing the frequency range  
& returning in 1 minute; 3 right angled directions for 2 hours  
**Shock:** 50G (490m/s<sup>2</sup>) acceleration (tested in 6 right angled directions, with 5 shocks in each direction)

**PCB Processing**

**Soldering:** Wave Soldering Recommended. See Profile A in Supplement section.  
Manual Soldering: See Profile B in Supplement section.  
**Cleaning:** Automated cleaning. See Cleaning Specifications in Supplement section.

**Standards & Certifications**

The A Series toggles have not been tested for UL recognition or CSA certification. These switches are designed for use in a low-voltage, low-current, logic-level circuit. When used as intended in a logic-level circuit, the results do not produce hazardous energy.



# Distinctive Characteristics

Subminiature size saves space on PC boards.

Specifically developed for logic-level applications.

Totally sealed body construction prevents contact contamination and allows time- and money-saving automated soldering and cleaning.

Award-winning STC contact mechanism with benefits unavailable in conventional mechanisms: smoother, positive detent actuation, increased contact stability and unparalleled logic-level reliability. (Additional STC details in Terms & Acronyms; see Supplement contents.)

Molded-in, epoxy sealed or ultrasonically welded terminals lock out flux, solvents, and other contaminants.

.100" x .100" (2.54mm x 2.54mm) terminal spacing conforms to standard PC board grid spacing.

Toggle option in antistatic material available for dissipating electrostatic discharges.

Matching indicators available.

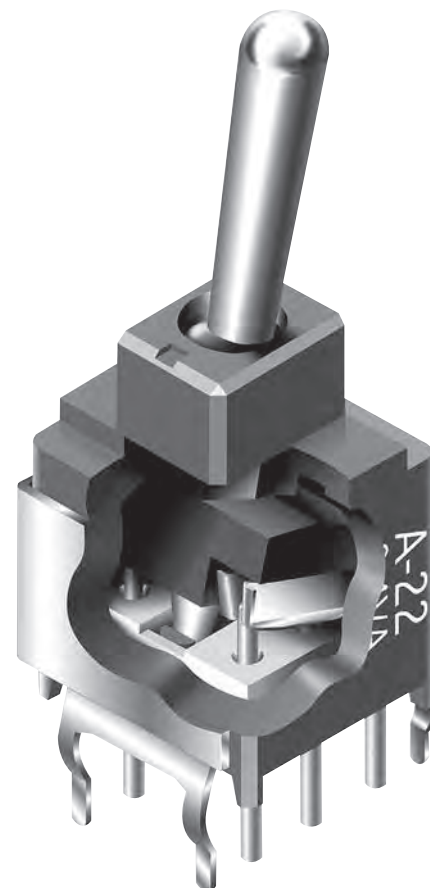

Actual Size

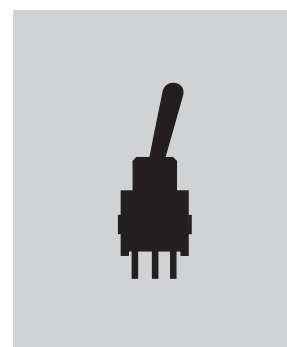

- A Toggles
- Rockers
- Pushbuttons
- Illuminated PB
- Programmable
- Key locks
- Rotaries
- Slides
- Tactiles
- Tilt
- Touch
- Indicators
- Accessories
- Supplement

### TYPICAL SWITCH ORDERING EXAMPLE

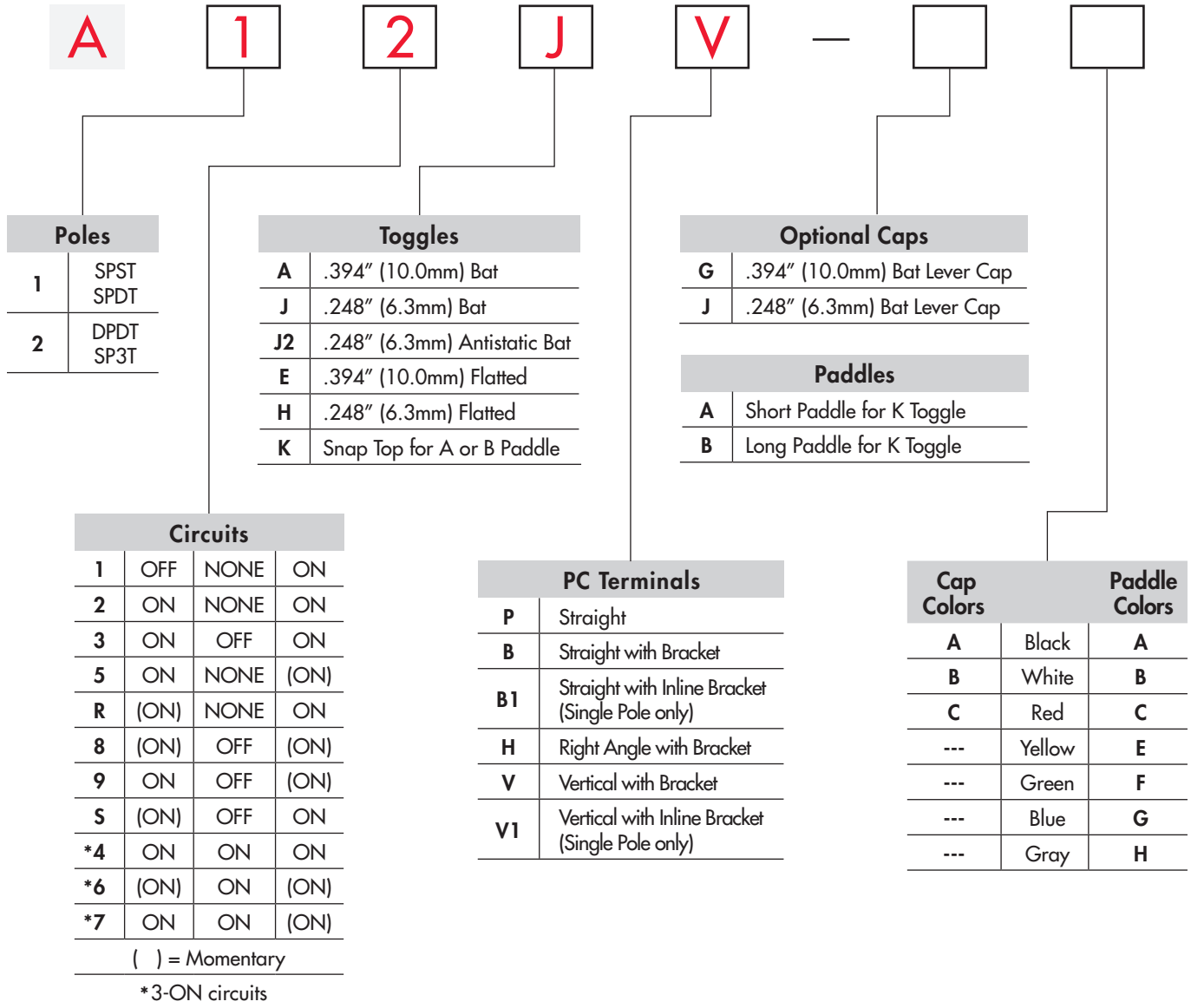

### DESCRIPTION FOR TYPICAL ORDERING EXAMPLE

#### A12JV



## POLES & CIRCUITS

Pole	Model	Toggle Position ( ) = Momentary			Connected Terminals			Throw & Schematics
		Up	Center	Down	Up	Center	Down	
SP	A11	OFF	NONE	ON	OPEN	OPEN	3-1	SPST Note: Terminal numbers are not actually on the switch. 
SP	A12 A13 A15 A1R A18 A19 A1S	ON ON ON (ON) (ON) ON (ON)	NONE OFF NONE NONE OFF OFF OFF	ON ON (ON) ON (ON) (ON) ON	2-3	OPEN	2-1	SPDT 
DP	A22 A23 A25 A2R A28 A29 A2S	ON ON ON (ON) (ON) ON (ON)	NONE OFF NONE NONE OFF OFF OFF	ON ON (ON) ON (ON) (ON) ON	2-3 5-6	OPEN	2-1 5-4	DPDT 

For 3 Throw (3-on)

Pole	Model	Connected Terminals & Schematics			External Connection
		Up	Center	Down	
SP	A24 A26 A27	ON (ON) ON	ON ON ON	ON (ON) (ON)	The SP3T model utilizes a double pole base.  External connections must be made during field installation. 

## TOGGLES

Standard Material & Finish: Brass with Bright Nickel    Material & Finish for J2: Matte finish black glass fiber reinforced polyamide

**A** .394" (10.0mm) Bat

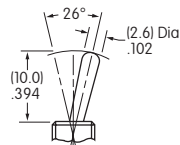

**J** .248" (6.3mm) Bat

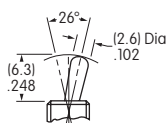

**J2** .248" (6.3mm) Antistatic Bat

Dissipating 20Kv ESD: Straight PC

Dissipating 10Kv ESD: Straight PC with Bracket, Right Angle, & Vertical

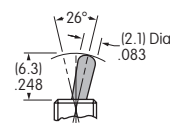

**E** .394" (10.0mm) Flatted

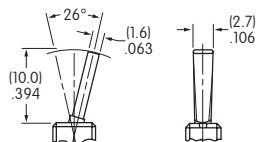

**H** .248" (6.3mm) Flatted

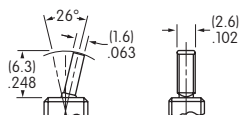

**K** Snap Top for Paddles

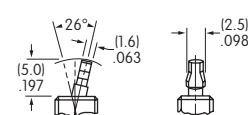

## PC TERMINALS

Use of a support bracket is recommended to increase PCB mounting strength and stability.

**P** Straight

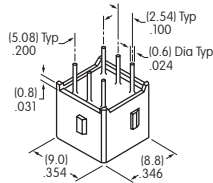

**B** Straight with Bracket

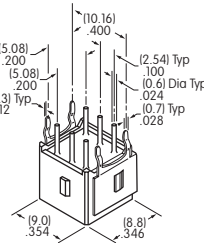

**B1** Straight with Inline Bracket  
Single Pole only

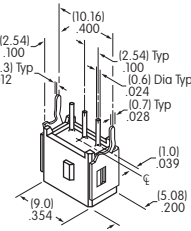

**H** Right Angle  
with Bracket

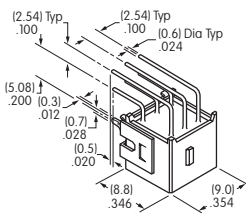

**V** Vertical with Bracket

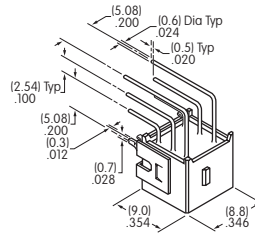

**V1** Vertical with Inline Bracket  
Single Pole only

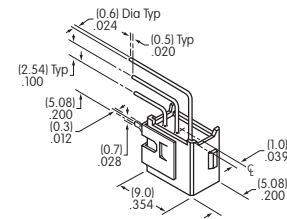

## CAPS & PADDLES

**G** AT4003  
.394" (10.0mm) Bat Lever Cap

Material: PVC  
Colors Available:  
A, B, C

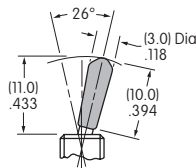

**J** AT4064  
.248" (6.3mm) Bat Lever Cap

Material: PVC  
Colors Available:  
A, B, C

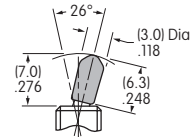

**A** AT467  
Short Paddle

Material: Polyamide  
Colors Available:  
A, B, C, E, F, G, H

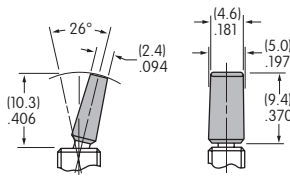

**B** AT468  
Long Paddle

Material: Polyamide  
Colors Available:  
A, B, C, E, F, G, H

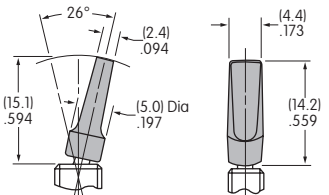

Color Codes:

**A** Black   **B** White   **C** Red   **E** Yellow   **F** Green   **G** Blue   **H** Gray

TYPICAL SWITCH DIMENSIONS

Single Pole

Straight PC

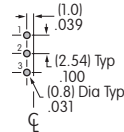
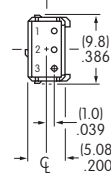
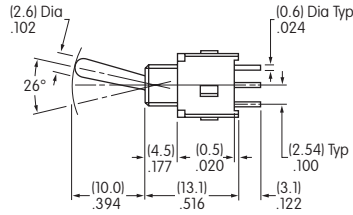
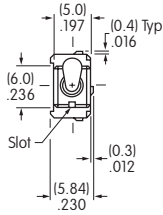

A11 models do not have Terminal 2

A12AP

Double Pole

Straight PC

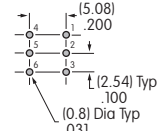
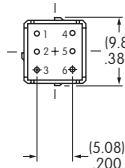
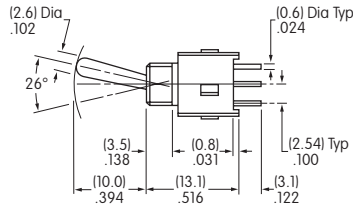
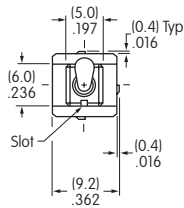

A22AP

Single Pole

Straight PC • Bracket

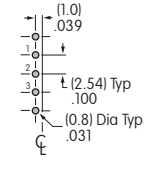
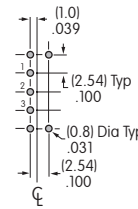
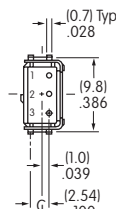
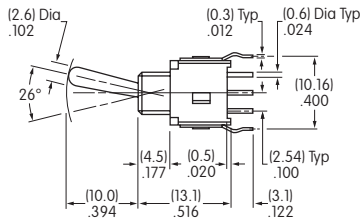
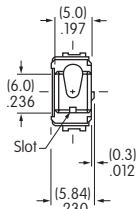

B Terminals

B1 Terminals

A12AB

Double Pole

Straight PC • Bracket

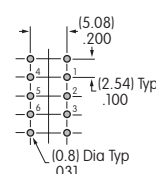
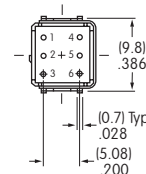
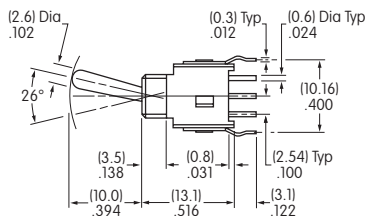
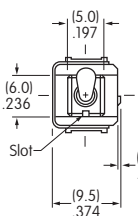

A22AB

## TYPICAL SWITCH DIMENSIONS

Toggles

Rockers

Pushbuttons

Illuminated PB

Programmable

Keylocks

Rotaries

Slides

Tactiles

Tilt

Touch

Indicators

Accessories

Supplement

### Right Angle PC

### Single Pole

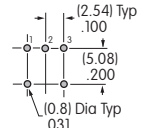
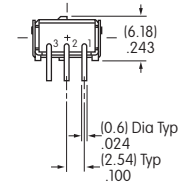
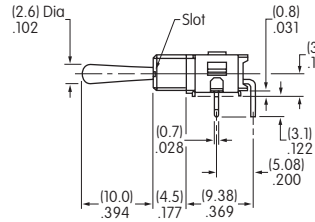
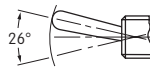
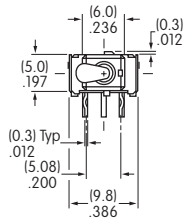

**A12AH**

### Right Angle PC

### Double Pole

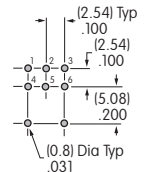
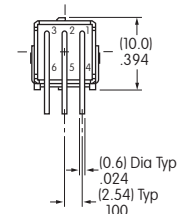
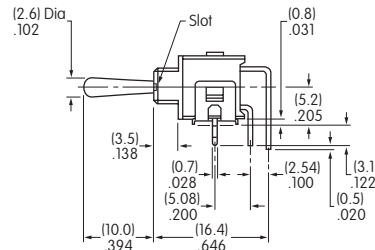
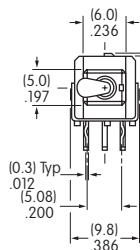

**A22AH**

### Vertical PC

### Single Pole

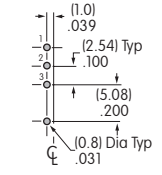
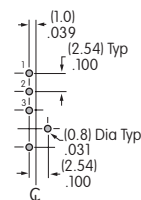
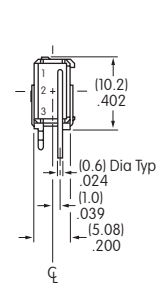
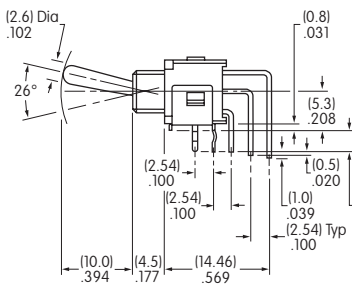
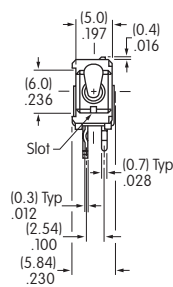

**A12AV**

V Terminals

V1 Terminals

### Vertical PC

### Double Pole

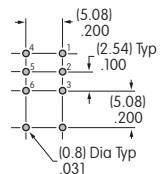
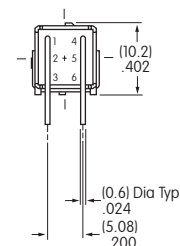
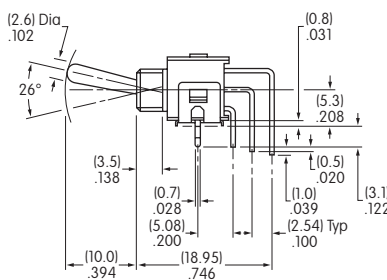
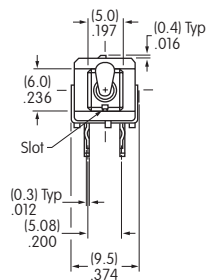

**A22AV**



# A General Specifications

## Electrical Capacity (Resistive Load)

**Logic Level:** 0.4VA maximum @ 28V AC/DC maximum  
(Applicable Range 0.1mA ~ 0.1A @ 20mV ~ 28V)  
Note: Find additional explanation of operating range in Supplement section.

## Other Ratings

**Contact Resistance:** 50 milliohms maximum  
**Insulation Resistance:** 500 megohms minimum @ 500V DC  
**Dielectric Strength:** 500V AC minimum for 1 minute minimum  
**Mechanical Life:** 100,000 operations minimum for On-None-On & On-Off-On  
50,000 operations minimum for other circuits  
50,000 operations minimum for locking lever models

**Electrical Life:** 50,000 operations minimum  
**Nominal Operating Force:** Toggles A, A1, E & K with Long Paddle: 1.47N (momentary); 1.18N (maintained)  
Toggles J & H & K with Short Paddle: 2.72N (momentary); 1.84N (maintained)  
Toggle L: 0.59N

**Contact Timing:** Nonshorting (break-before-make)  
**Angle of Throw:** 26°

## Materials & Finishes

**Toggle:** Nickel plated brass  
**Bushing:** Carbon blended polyamide; nickel plated zinc alloy for locking levers & threaded bushing  
**Gasket:** Nitrile butadiene rubber  
**Case Housing:** Glass fiber reinforced polyamide  
**Support Bracket:** Tin plated phosphor bronze  
**Movable Contact:** Phosphor bronze with gold plating  
**Stationary Contacts:** Copper alloy with gold plating  
**Terminals:** Copper alloy with gold plating

## Environmental Data

**Operating Temperature Range:** -30°C through +85°C (-22°F through +185°F)  
**Humidity:** 90 ~ 95% humidity for 96 hours @ 40°C (104°F)  
**Vibration:** 10 ~ 55Hz with peak-to-peak amplitude of 1.5mm traversing the frequency range & returning in 1 minute; 3 right angled directions for 2 hours  
**Shock:** 50G (490m/s<sup>2</sup>) acceleration (tested in 6 right angled directions, with 5 shocks in each direction)

## Installation

**Mounting Torque:** .30 ~ .45Nm (2.65 ~ 3.98 lb•in) for A1 actuator with threaded bushing only

## PCB Processing

**Soldering:** Wave Soldering Recommended: See Profile A in Supplement section.  
Manual Soldering: See Profile A in Supplement section.  
**Cleaning:** Automated cleaning. See Cleaning specifications in Supplement section.

## Standards & Certifications

**Flammability Standards:** UL94V-0 available  
The B Series toggles have not been tested for UL recognition or CSA certification.  
These switches are designed for use in a low-voltage, low-current, logic-level circuit.  
When used as intended in a logic-level circuit, the results do not produce hazardous energy.



# Distinctive Characteristics

Subminiature size saves space on PC boards.

Specifically developed for logic-level applications.

Antistatic superstructure, consisting of the carbon impregnated bushing and the support bracket, prevents static discharge to the contacts. Static electricity from an operator's touch travels from actuator through the bushing and bracket to the PC board.

Locking lever mechanism offered as a toggle option.

Optional threaded, 6mm diameter bushing for panel seal mounting meets IP65 of IEC60529 specifications (similar to NEMA 4 and 13).

Totally sealed body construction prevents contact contamination and allows time- and money-saving soldering and cleaning. Epoxy sealed terminals lock out flux and other contaminants.

Award-winning STC contact mechanism with benefits unavailable in conventional mechanisms: smoother, positive detent actuation, increased contact stability and unparalleled logic-level reliability. (Additional STC details in Terms & Acronyms; see Supplement section.)

.100" x .100" (2.54mm x 2.54mm) terminal spacing conforms to standard PC board grid spacing.

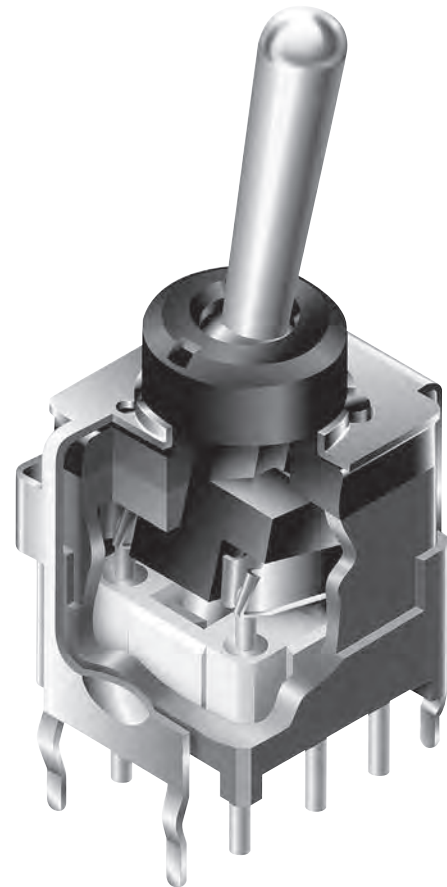

Actual Size

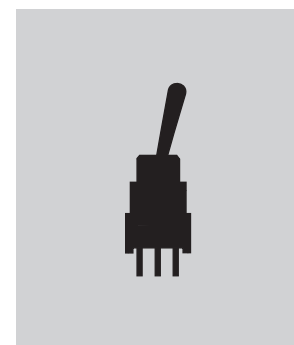

- A Toggles
- Rockers
- Pushbuttons
- Illuminated PB
- Programmable
- Key locks
- Rotaries
- Slides
- Tactiles
- Tilt
- Touch
- Indicators
- Accessories
- Supplement

### TYPICAL SWITCH ORDERING EXAMPLE

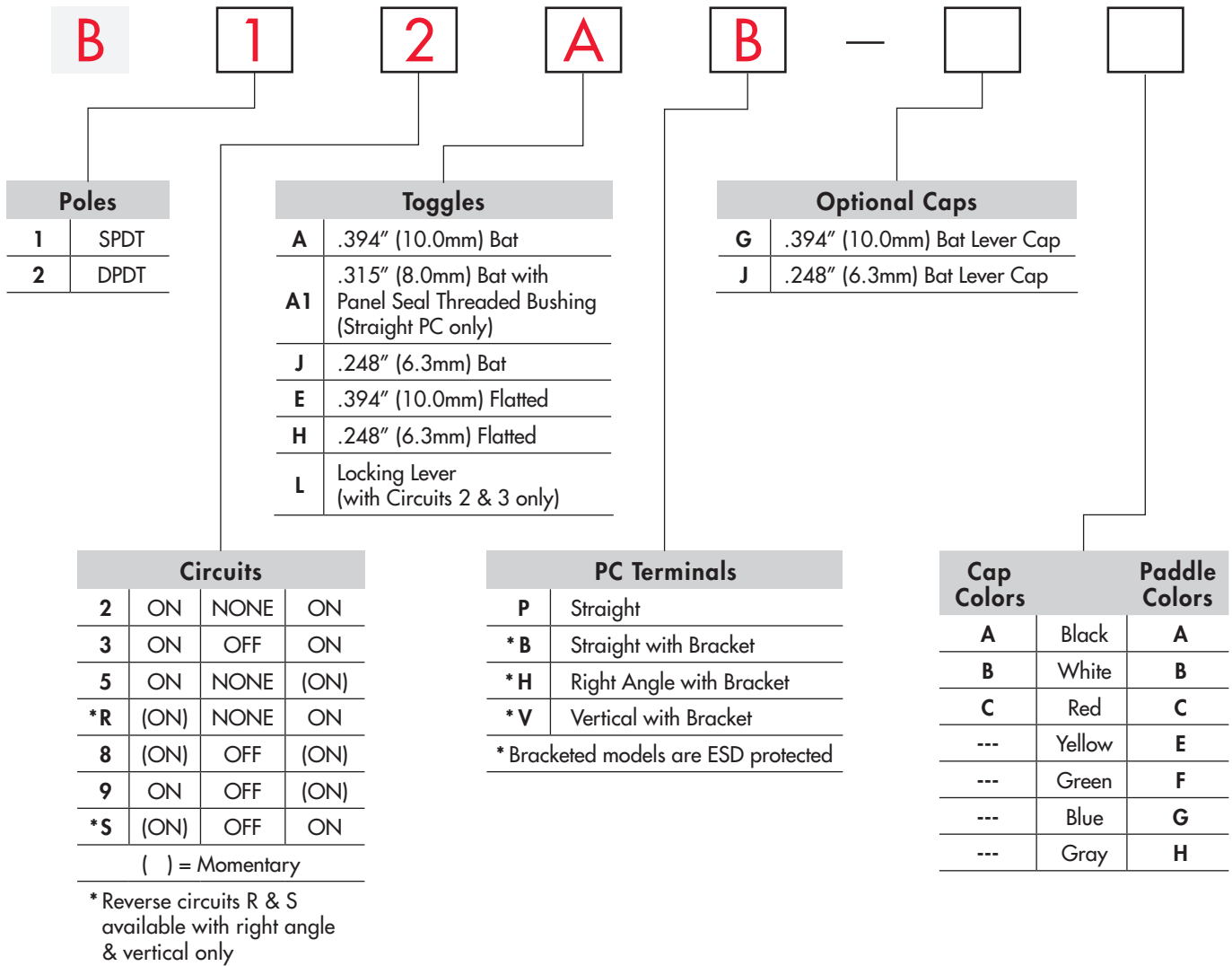

### DESCRIPTION FOR TYPICAL ORDERING EXAMPLE

**B12AB**

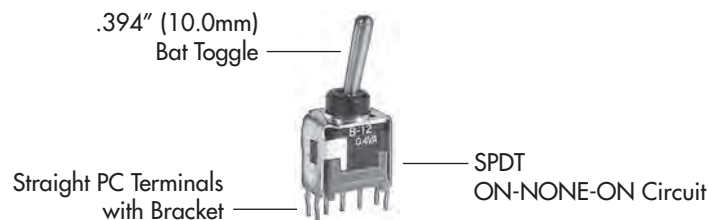

## POLES & CIRCUITS

Pole	Model	Toggle Position ( ) = Momentary			Connected Terminals			Throw & Schematics
		Up	Center	Down	Up	Center	Down	
								Note: Terminal numbers are not actually on the switch.
SP	B12 B13 B15 B1R B18 B19 B1S	ON ON ON (ON) (ON) ON (ON)	NONE OFF NONE NONE OFF OFF OFF	ON ON (ON) ON (ON) (ON) ON	2-3	OPEN	2-1	SPDT 
DP	B22 B23 B25 B2R B28 B29 B2S	ON ON ON (ON) (ON) ON (ON)	NONE OFF NONE NONE OFF OFF OFF	ON ON (ON) ON (ON) (ON) ON	2-3 5-6	OPEN	2-1 5-4	DPDT 

## TOGGLES

Standard Material & Finish: Brass with Bright Nickel

**A** .394" (10.0mm)  
Bat

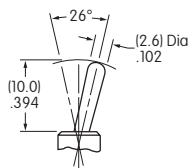

**A1** .315" (8.0mm) Bat with  
Panel Seal Threaded Bushing

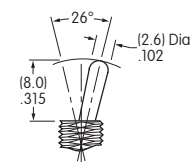

**J** .248" (6.3mm)  
Bat

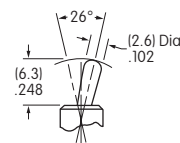

**E** .394" (10.0mm)  
Flatted

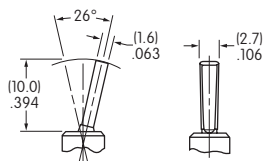

**H** .248" (6.3mm) Flatted

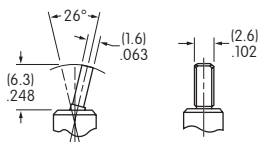

**L** Locking Lever

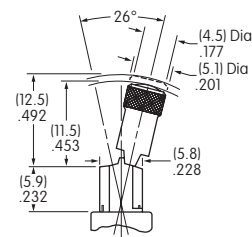

## PC TERMINALS

Use of a support bracket is recommended to increase PCB mounting strength and stability.

**P** Straight

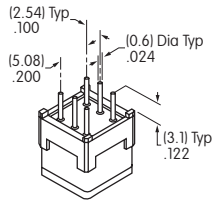

**B** Straight with Bracket

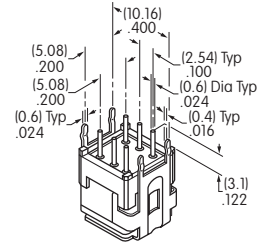

**H** Right Angle with Bracket

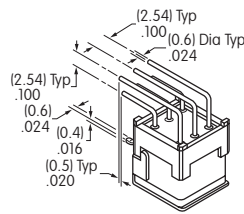

**V** Vertical with Bracket

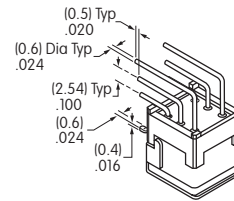

## OPTIONAL CAPS

**G** AT4003  
.394" (10.0mm) Bat Lever Cap

Material: PVC  
Colors Available:  
A, B, C

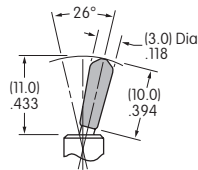

**J** AT4064  
.248" (6.3mm) Bat Lever Cap

Material: PVC  
Colors Available:  
A, B, C

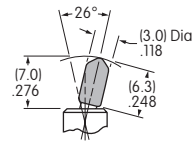

### Color Codes:

- A** Black
- B** White
- C** Red
- E** Yellow
- F** Green
- G** Blue
- H** Gray

## TYPICAL SWITCH DIMENSIONS

### Single Pole

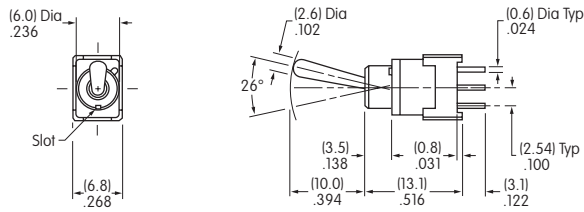

### Straight PC

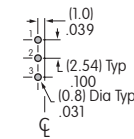

**B12AP**

### Double Pole

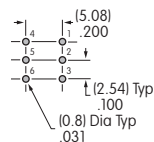
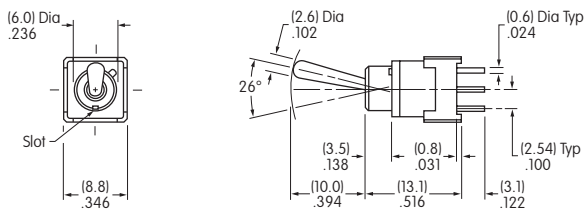

**B22AP**

### Single Pole

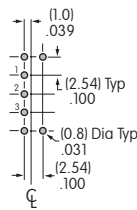
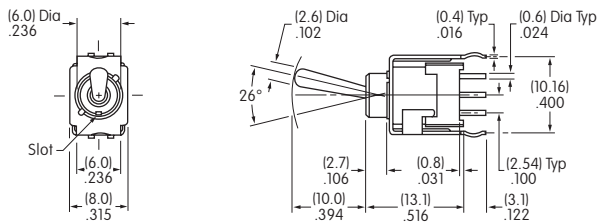

**B12AB**

### Double Pole

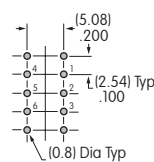
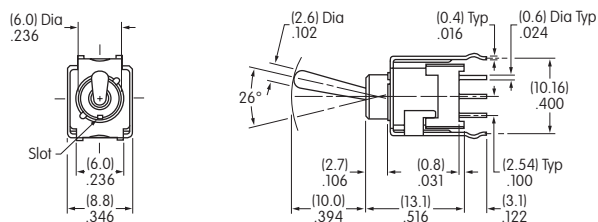

**B22AB**

### Single Pole

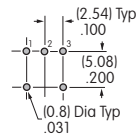
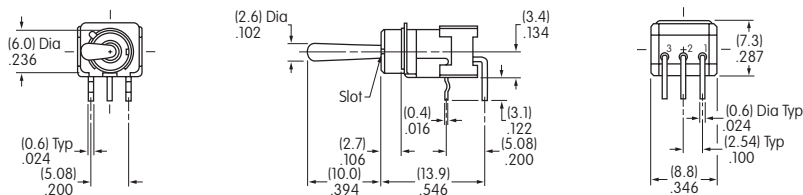

**B12AH**

A  
Toggles

Rockers

Pushbuttons

Illuminated PB

Programmable

Key locks

Rotaries

Slides

Tactiles

Tilt

Touch

Indicators

Accessories

Supplement

## TYPICAL SWITCH DIMENSIONS

### Right Angle PC



**B22AH**

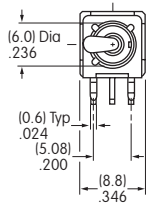

### Double Pole

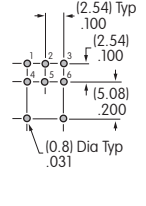
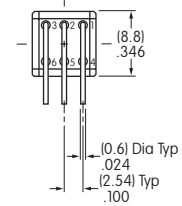
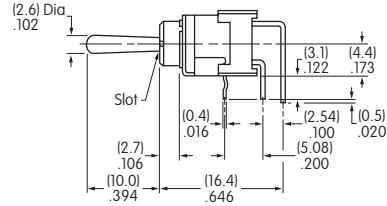

### Vertical PC



**B12AV**

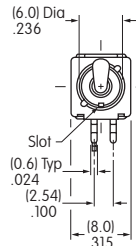

### Single Pole

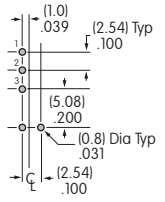
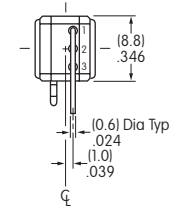
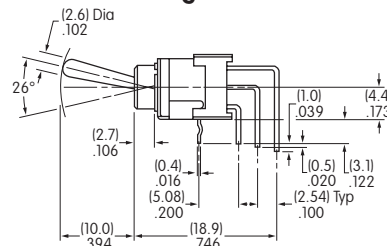

### Vertical PC



**B22AV**

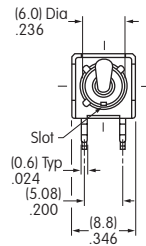

### Double Pole

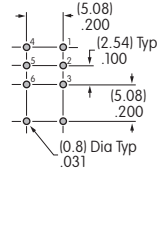
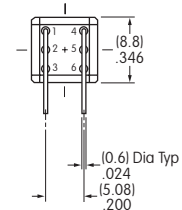
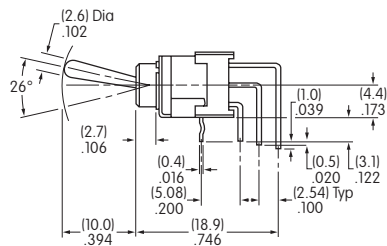

### Locking Lever • Straight PC • Bracket



**B12LB**

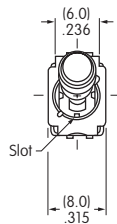

### Single Pole

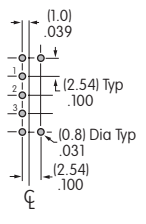
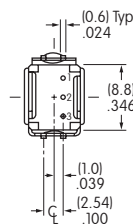
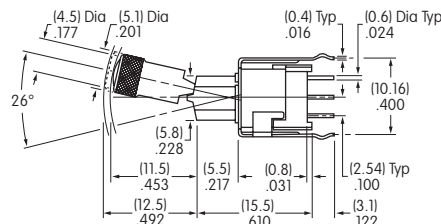

### Locking Lever • Straight PC • Bracket



**B22LB**

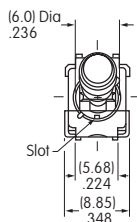

### Double Pole

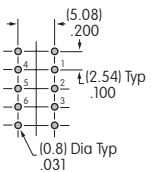
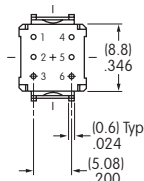
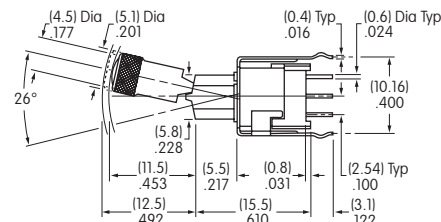

Toggles  
 Rockers  
 Pushbuttons  
 Illuminated PB  
 Programmable  
 Keylocks  
 Rotaries  
 Slides  
 Tactiles  
 Locking Lever • Straight PC • Bracket  
 Tilt  
 Touch  
 Indicators  
 Accessories  
 Supplement

TYPICAL SWITCH DIMENSIONS

Panel Seal • Single Pole

Threaded Bushing • Straight PC

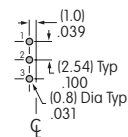
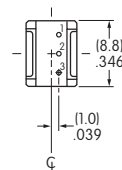
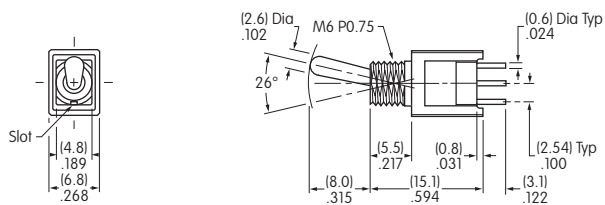

B12A1P

Panel Seal • Double Pole

Threaded Bushing • Straight PC

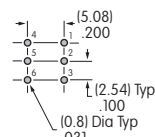
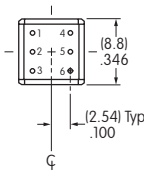
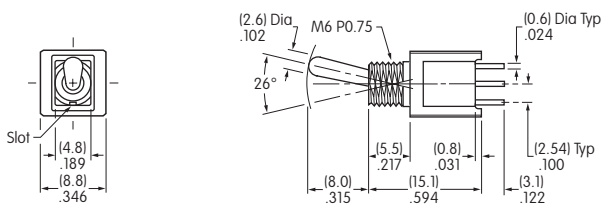

B22A1P

STANDARD HARDWARE & PANEL CUTOUT

AT513M  
Metric Hex Nut

Material:  
Brass,  
Nickel plated

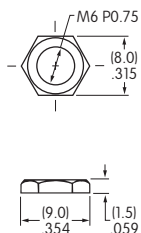

AT063  
Gasket

Material:  
Nitrile butadiene  
rubber

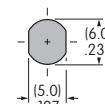
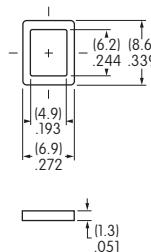

Maximum Panel Thickness  
with Standard Hardware:  
.087" (2.2mm)

# General Specifications

## Electrical Capacity (Resistive Load)

**Logic Level:** 0.4VA maximum @ 28V AC/DC maximum  
(Applicable Range 0.1mA ~ 0.1A @ 20mV ~ 28V)  
Note: Find additional explanation of operating range in Supplement section.

## Other Ratings

**Contact Resistance:** 50 milliohms maximum  
**Insulation Resistance:** 500 megohms minimum @ 500V DC  
**Dielectric Strength:** 500V AC minimum for 1 minute minimum  
**Mechanical Life:** 100,000 operations minimum  
**Electrical Life:** 50,000 operations minimum  
**Nominal Operating Force:** 1.18N  
**Contact Timing:** Nonshorting (break-before-make)  
**Angle of Throw:** 26°

## Materials & Finishes

**Actuator:** Polyamide  
**Bushing Housing:** Polyamide  
**Case Housing:** Glass fiber reinforced polyamide  
**Support Bracket:** Phosphor bronze with tin plating  
**Movable Contact:** Phosphor bronze with gold plating  
**Stationary Contacts:** Brass with tin plating  
**Terminals:** Brass with gold plating

## Environmental Data

**Operating Temperature Range:** -25°C through +55°C (-13°F through +131°F)  
**Humidity:** 90 ~ 95% humidity for 240 hours @ 40°C (104°F)  
**Vibration:** 10 ~ 55Hz with peak-to-peak amplitude of 1.5mm traversing the frequency range & returning in 5 minutes; 3 right angled directions for 2 hours  
**Shock:** 50G (490m/s<sup>2</sup>) acceleration (tested in 3 right angled directions, with 5 shocks in each direction)

## PCB Processing

**Soldering:** Wave Soldering recommended. See Profile A in Supplement section.  
Manual Soldering: See Profile A in Supplement section.  
**Cleaning:** Automated alcohol based cleaning recommended, 5 minutes maximum. Do not use high-purity alcohol (50% alcohol or more) or organic solvent. High alcohol solution can damage clear plastic. See Cleaning specifications in Supplement section.

## Standards & Certifications

The B Series illuminated toggles have not been tested for UL recognition or CSA certification. These switches are designed for use in a low-voltage, low-current, logic-level circuit. When used as intended in a logic-level circuit, the results do not produce hazardous energy.



# Distinctive Characteristics

LED provides maximum illumination to bushing and actuator, indicating actuator status in highly visible green, red, or amber for single color or red/green for bicolor.

Totally sealed body construction prevents contact contamination and allows time- and money-saving automated soldering and cleaning. Molded-in, epoxy sealed terminals lock out flux and other contaminants.

Award-winning STC contact mechanism with benefits unavailable in conventional mechanisms: smoother, positive detent actuation, increased contact stability, and unparalleled logic-level reliability. (Additional STC details in Terms & Acronyms; see Supplement section.)

.100" x .100" (2.54mm x 2.54mm) terminal spacing conforms to standard PC board grid spacing.

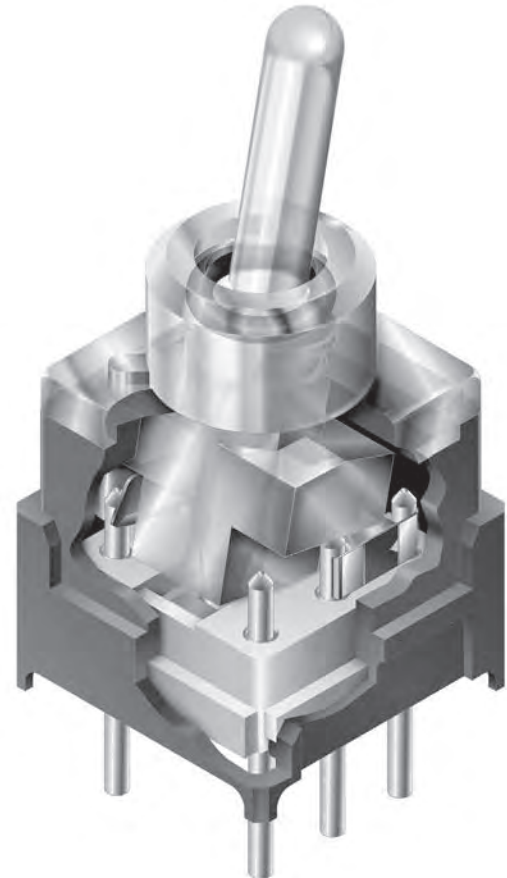

Actual Size

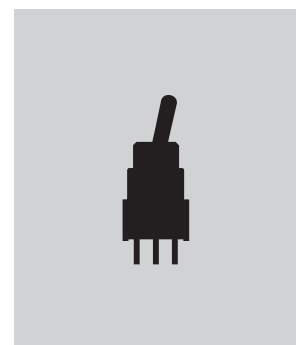

A Toggles

Rockers

Pushbuttons

Illuminated PB

Programmable

Keylocks

Rotaries

Slides

Tactiles

Tilt

Touch

Indicators

Accessories

Supplement

### TYPICAL SWITCH ORDERING EXAMPLE

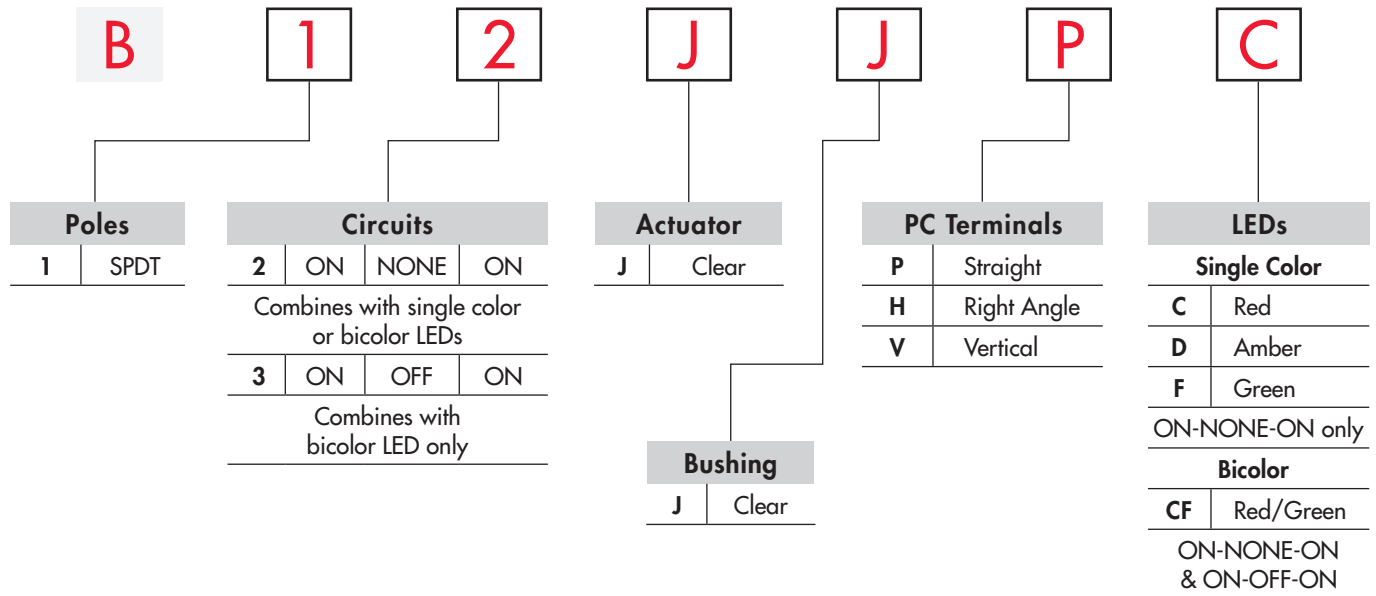

### DESCRIPTION FOR TYPICAL ORDERING EXAMPLE

**B12JJPC**

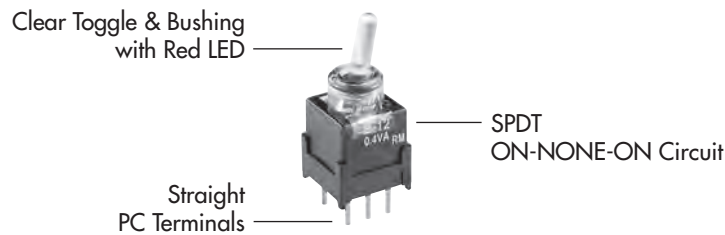

### POLE & CIRCUITS

Pole Throw	Model	Toggle Position			Connected Terminals			Throw & Schematics
		Up	Center	Down	Up	Center	Down	
SPDT	<b>B12</b>	ON	NONE	ON	2-3	NONE	2-1	<p>Note: Terminal numbers are not actually on the switch. LED circuit is isolated and requires an external power source.</p> <p>Single Color</p> <p>Bicolor</p>
	<b>B13</b>	ON	OFF	ON	2-3	OPEN	2-1	

### ACTUATOR & BUSHING

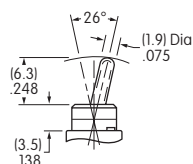

## LED COLORS & SPECIFICATIONS

LEDs are an integral part of the switch and not available separately. The electrical specifications shown are determined at a basic temperature of 25°C. If the source voltage exceeds the rated voltage, a ballast resistor is required. The resistor value can be calculated by using the formula in the Supplement section.

	Colors	Single Color			Bicolor
		<b>C</b> Red	<b>D</b> Amber	<b>F</b> Green	<b>CF</b> Red/Green
Maximum Forward Current	$I_{FM}$	30mA	30mA	25mA	30mA/25mA
Typical Forward Current	$I_F$	20mA	20mA	20mA	20mA/20mA
Forward Voltage	$V_F$	1.95V	2.0V	3.3V	1.95V/3.3V
Maximum Reverse Voltage	$V_{RM}$	5V	5V	5V	5V/5V
Current Reduction Rate Above 25°C	$\Delta I_F$	0.40mA/°C		0.33mA/°C	0.40mA/°C/0.33mA/°C
Ambient Temperature Range		-25°C ~ +55°C			

## PC TERMINALS

**P** Straight

**H** Right Angle with Bracket

**V** Vertical with Bracket

## TYPICAL SWITCH DIMENSIONS

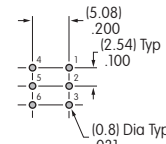
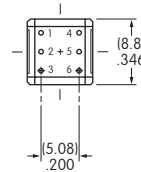
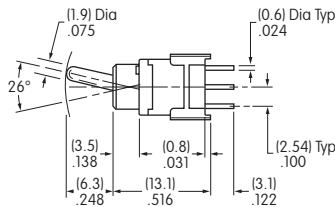
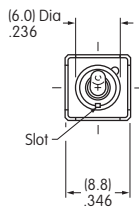

**Straight PC**



**B12JJPC**

Terminal 4 is a support pin on single color models.

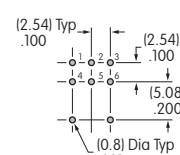
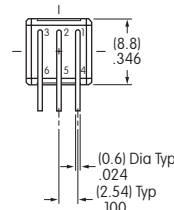
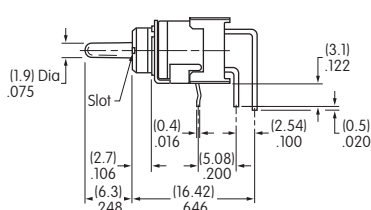
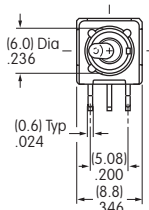
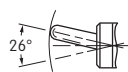

**Right Angle PC**



**B13JJHCF**

Terminal 4 is a support pin on single color models.

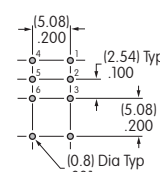
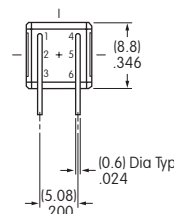
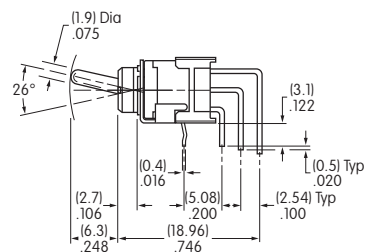
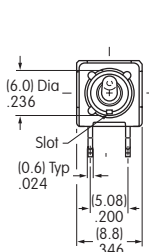

**Vertical PC**



**B13JJVCF**

Terminal 4 is a support pin on single color models.

# General Specifications

## Electrical Capacity (Resistive Load)

**Logic Level:** 0.4VA maximum @ 48V AC/DC maximum  
(Applicable Range 0.1mA ~ 0.1A @ 20mV ~ 48V)  
Note: Find additional explanation of operating range in Supplement section.

## Other Ratings

**Contact Resistance:** 50 milliohms maximum  
**Insulation Resistance:** 1,000 megohms minimum @ 500V DC  
**Dielectric Strength:** 1,000V AC minimum between contacts for 1 minute minimum;  
1,500V AC minimum between contacts & case for 1 minute minimum  
**Mechanical Life:** 100,000 operations minimum for bat lever models  
50,000 operations minimum for locking lever models  
**Electrical Life:** 50,000 operations minimum  
**Contact Timing:** Nonshorting (break-before-make)  
**Angle of Throw:** 24°

## Materials & Finishes

**Toggle/Lever:** Brass with chrome plating  
**Bushing:** Brass with nickel plating  
**Support Bracket:** Straight PC: phosphor bronze with tin plating; right angle & vertical: brass with tin plating  
**Housing:** Polybutylene terephthalate (PBT) (UL94V-0)  
**Base:** 1- and 2-pole GFR polyamide (UL94V-0); 4-pole liquid crystal polymer (LCP) (UL94V-0)  
**Movable Contacts:** Phosphor bronze with gold plating  
**Stationary Contacts:** Brass with gold plating  
**Terminals:** Brass with gold plating

## Environmental Data

**Operating Temp Range:** -10°C through +70°C (+14°F through +158°F)  
**Humidity:** 90 ~ 95% humidity for 240 hours @ 40°C (104°F)  
**Vibration:** 10 ~ 55Hz with peak-to-peak amplitude of 1.5mm traversing the frequency range & returning in 1 minute; 3 right angled directions for 2 hours  
**Shock:** 50G (490m/s<sup>2</sup>) acceleration (tested in 6 right angled directions, with 5 shocks in each direction)

## PCB Processing

**Soldering:** Wave Soldering recommended. See Profile A in Supplement section.  
Manual Soldering: 1- & 2-pole: 3 seconds maximum @ 350°C maximum;  
4-pole: 4 seconds maximum @ 410°C maximum  
**Cleaning:** Hand clean locally using alcohol based solution.  
See Cleaning specifications in Supplement section.

## Standards & Certifications

**Flammability Standards:** UL94V-0 rated housing & base  
The D2 Series toggles have not been tested for UL recognition or CSA certification.  
These switches are designed for use in a low-current, logic level circuit.  
When used as intended in a logic level circuit, the results do not produce hazardous energy.

# Distinctive Characteristics

Base of heat resistant resin meets UL94V-0 flammability rating.

Maximized voltage capability of 48V allows use in medium source applications and increases operating life.

Award-winning STC contact mechanism with benefits unavailable in conventional mechanisms: smoother positive detent actuation, increased contact stability, and unparalleled reliability. (Additional STC details under Terms and Acronyms in the Supplement section.)

Round .031" (0.8mm) diameter PC terminals for easy PCB assembly.

Terminal spacing conforms to standard .100" (2.54mm) PC board grid spacing.

Molded-in terminals prevent entry of flux, solvents, and other contaminants.

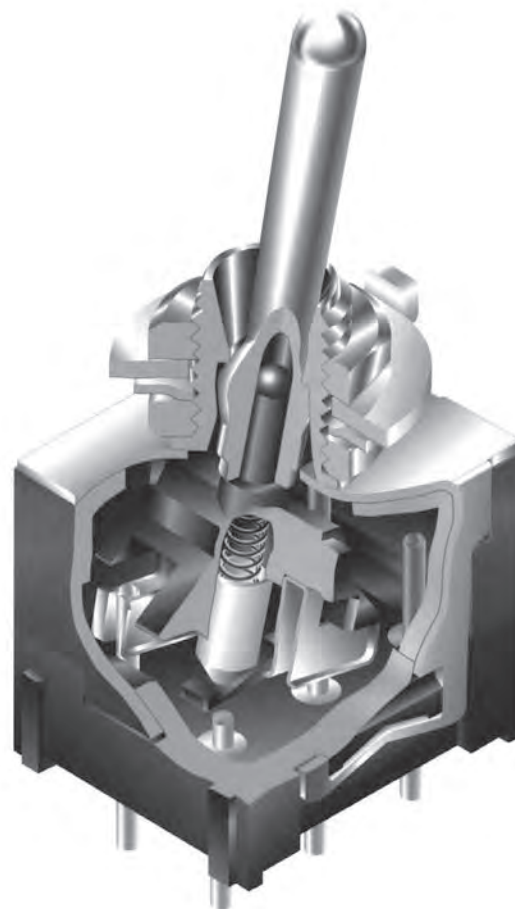

Actual Size

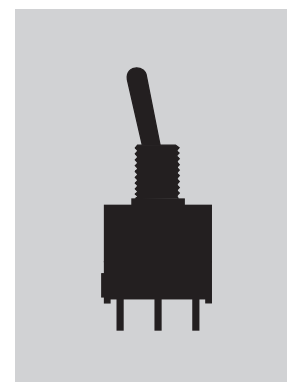

- A Toggles
- Rockers
- Pushbuttons
- Illuminated PB
- Programmable
- Keylocks
- Rotaries
- Slides
- Tactiles
- Tilt
- Touch
- Indicators
- Accessories
- Supplement

### TYPICAL SWITCH ORDERING EXAMPLE

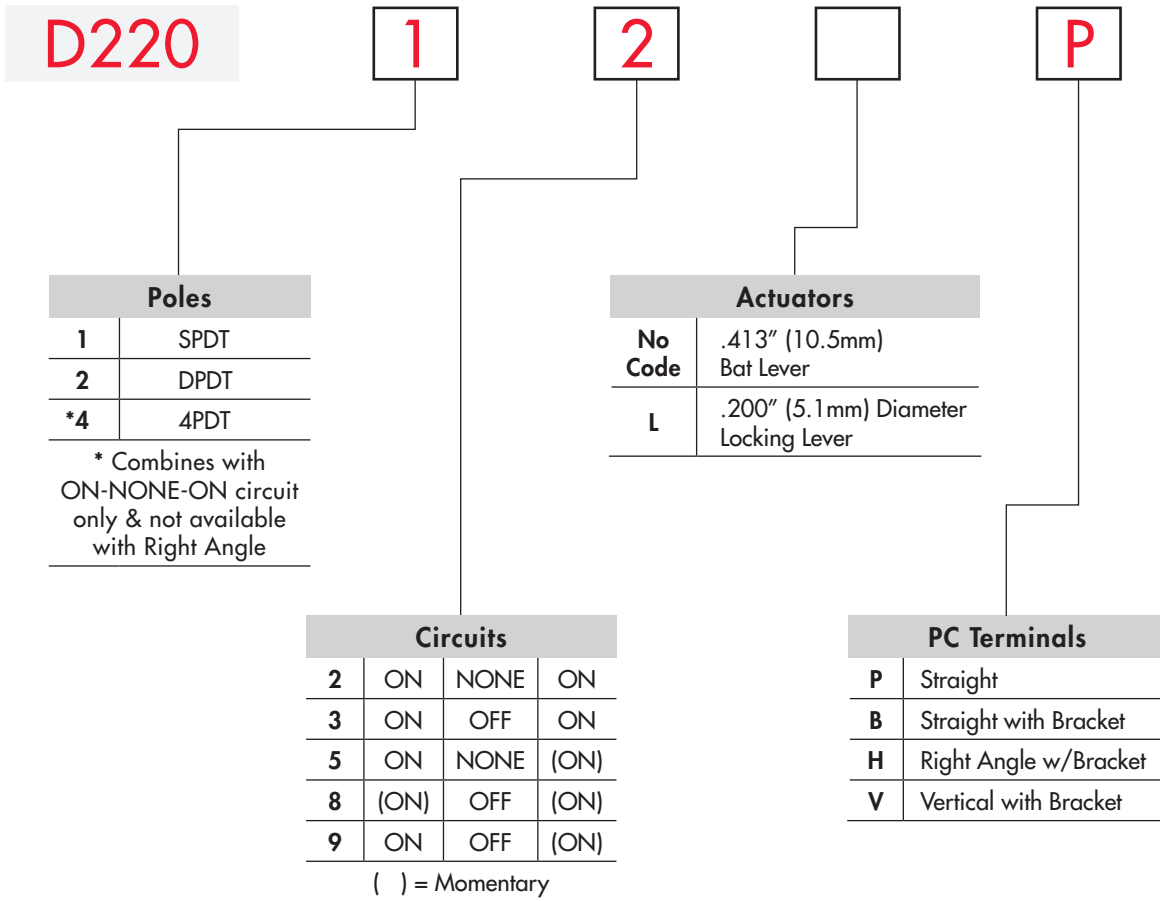







### DESCRIPTION FOR TYPICAL ORDERING EXAMPLE

#### D22012P

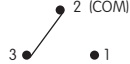
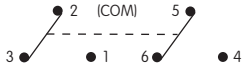
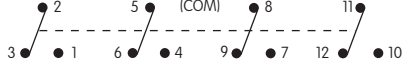

POLES & CIRCUITS

Pole	Model	Toggle Position ( ) = Momentary			Connected Terminals			Throw & Schematics
		Down 	Center 	Up 	Down 	Center 	Up 	
SP	D22012 D22013 D22015 D22018 D22019	ON ON ON (ON) ON	NONE OFF NONE OFF OFF	ON ON (ON) (ON) (ON)	2-3	OPEN	2-1	Note: Terminal numbers are not actually on the switch. 
DP	D22022 D22023 D22025 D22028 D22029	ON ON ON (ON) ON	NONE OFF NONE OFF OFF	ON ON (ON) (ON) (ON)	2-3 5-6	OPEN	2-1 5-4	
4P	D22042	ON	NONE	ON	2-3 5-6 8-9 11-12	OPEN	2-1 5-4 8-7 11-10	

ACTUATORS

No Code

.413" (10.5mm)  
Bat Lever

Material:  
Chrome over brass

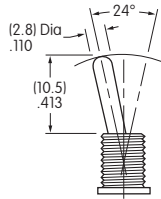

L

.413" (5.1mm) Diameter  
Locking Lever

Material:  
Chrome over brass

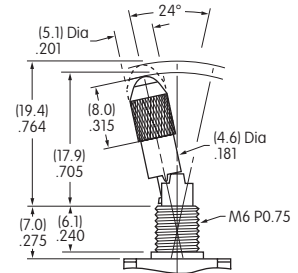

PC TERMINALS

P

Straight



B

Straight with Bracket



H

Right Angle with Bracket



V

Vertical with Bracket

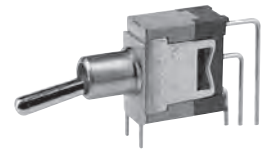

OPTIONAL CAPS & CAP COLORS

AT415  
Bat Lever Cap

Material:  
Polyethylene

Colors Available:  
A B C E F G

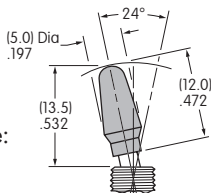

AT444 Bat Lever  
Conical Cap

Material:  
Polyethylene

Colors Available:  
A B C E F G

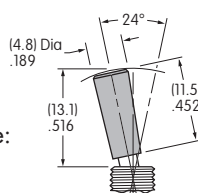

AT427 Cap Supplied  
with Locking Lever

Material:  
Anodized  
Aluminum

Colors Available:  
A C G

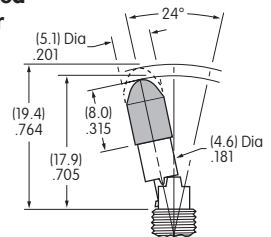

Colors Codes: A Black B White C Red E Yellow F Green G Blue

## TYPICAL SWITCH DIMENSIONS

### Straight PC • Single Pole



D22012P

D22012LP

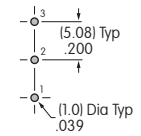
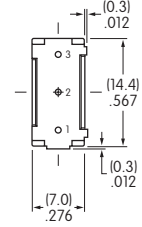
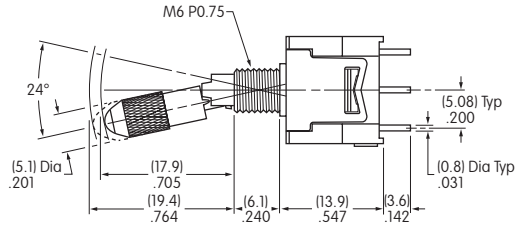
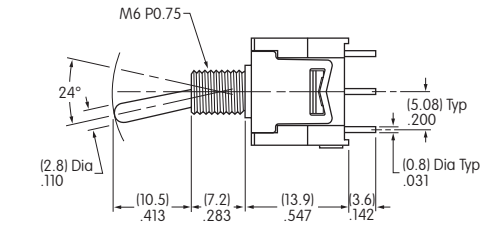
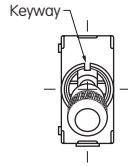
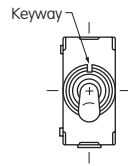

Actuator in Down Position

### Straight PC • Double Pole



D22022P

D22022LP

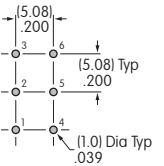
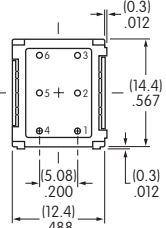
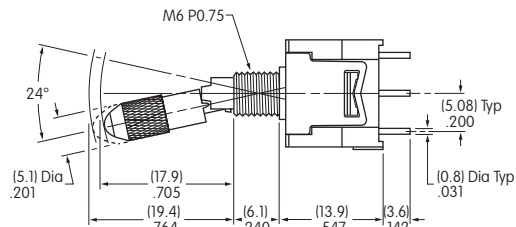
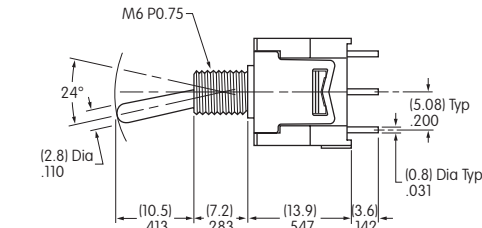
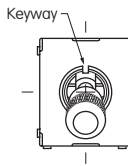
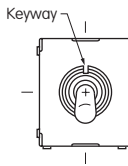

Actuator in Down Position

### Straight PC • Four Pole

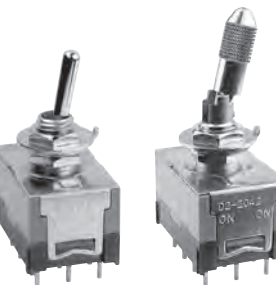

D22042P

D22042LP

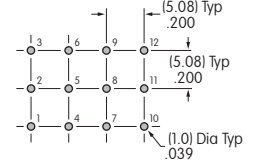
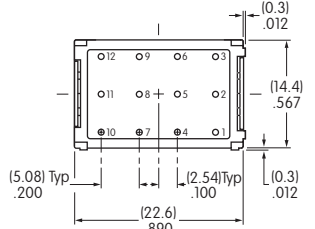
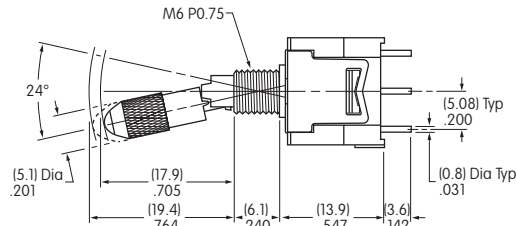
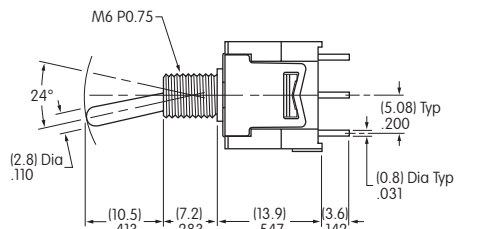
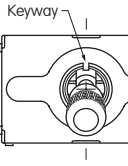
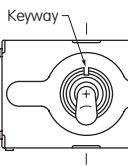

Actuator in Down Position

Rockers

Pushbuttons

Illuminated PB

Programmable

Keylocks

Rotaries

Slides

Tactiles

Tilt

Touch

Indicators

Accessories

Supplement



TYPICAL SWITCH DIMENSIONS

A  
Toggles

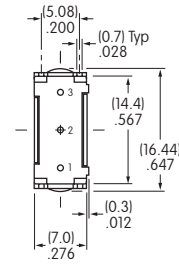
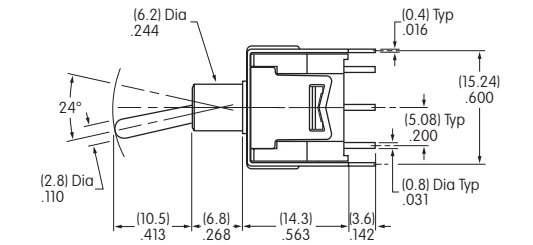
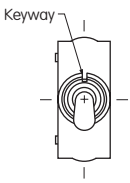

Straight PC • Bracket  
Single Pole

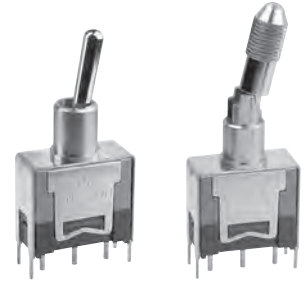

D22012B

D22012LB

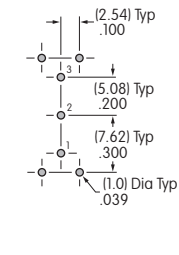
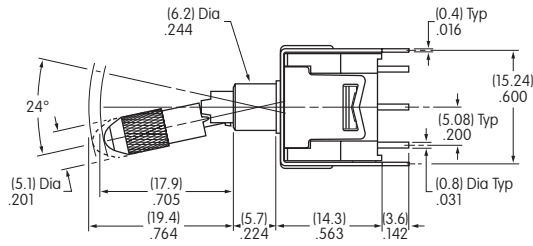
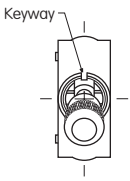

Actuator in Down Position

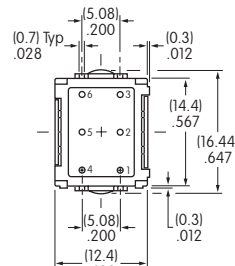
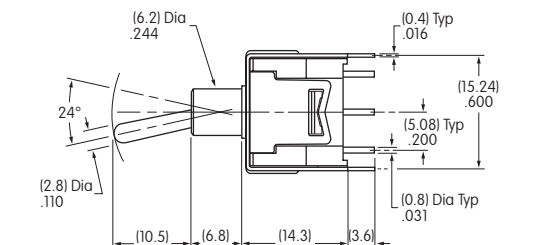
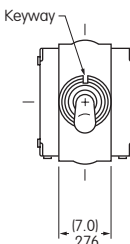

Straight PC • Bracket  
Double Pole

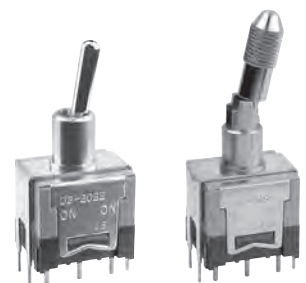

D22022B

D22022LB

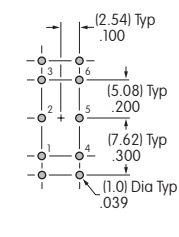
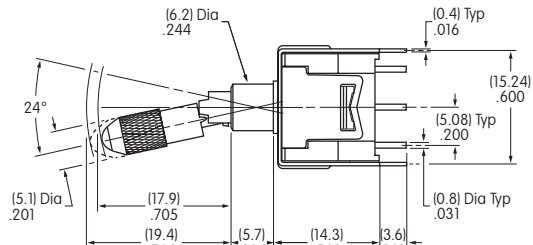
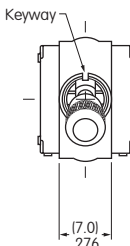

Actuator in Down Position

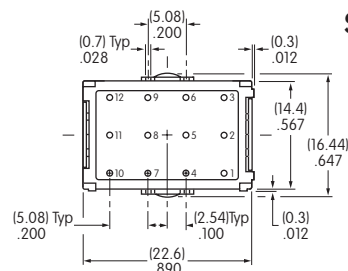
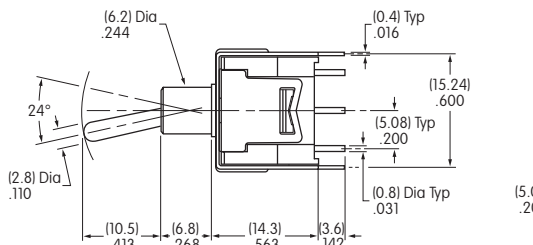
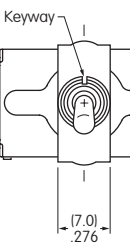

Straight PC • Bracket  
Four Pole

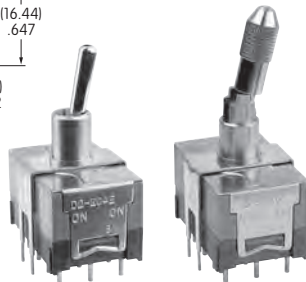

D22042B

D22042LB

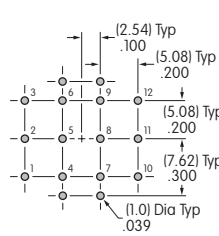
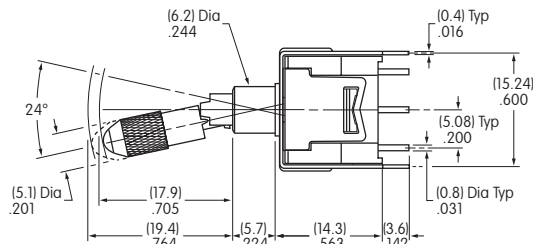
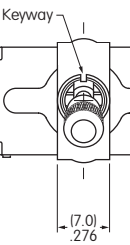

Actuator in Down Position

Rockers

Pushbuttons

Illuminated PB

Programmable

Key locks

Rotaries

Slides

Tactiles

Tilt

Touch

Indicators

Accessories

Supplement

## TYPICAL SWITCH DIMENSIONS

### Right Angle PC • Single Pole

Rockers

Pushbuttons

Illuminated PB

Programmable

Keylocks

Rotaries



**D22012H**

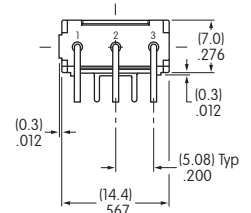
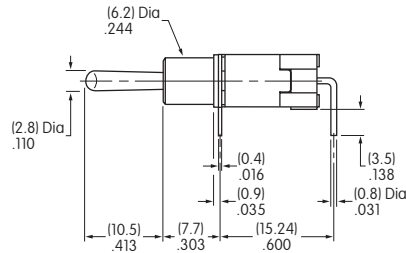
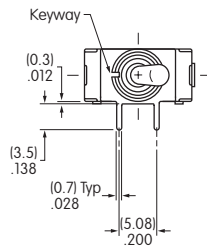

**D22012LH**

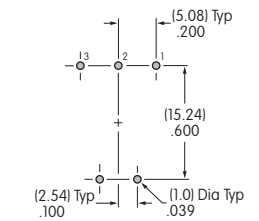
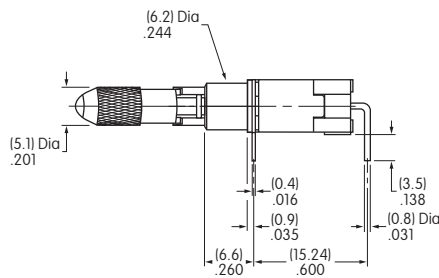
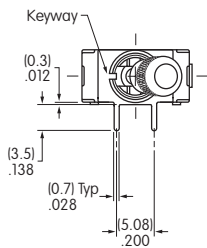

Actuator in Down Position

Slides

Tactiles

Tilt

Touch

Indicators

Accessories

Supplement

### Right Angle PC • Double Pole



**D22022H**

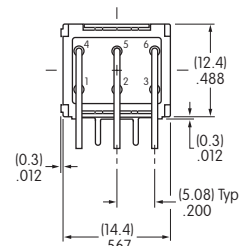
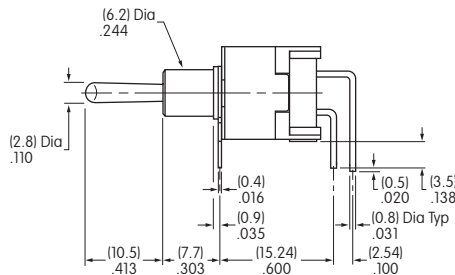
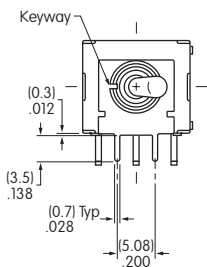

**D22022LH**

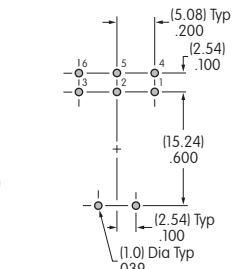
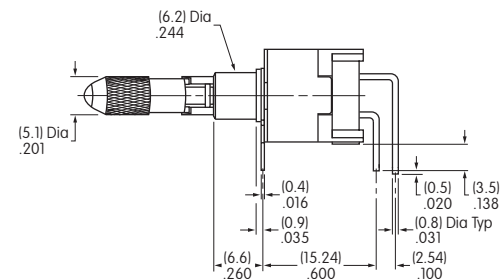
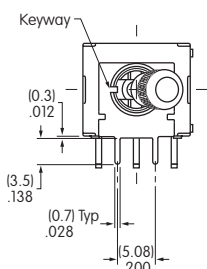

Actuator in Down Position

TYPICAL SWITCH DIMENSIONS

Vertical PC • Single Pole

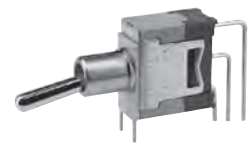
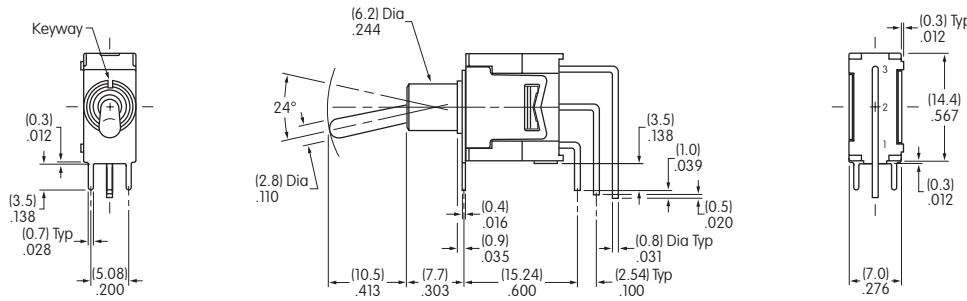

D22012V

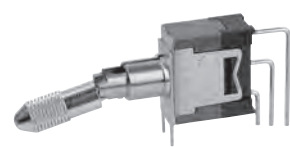
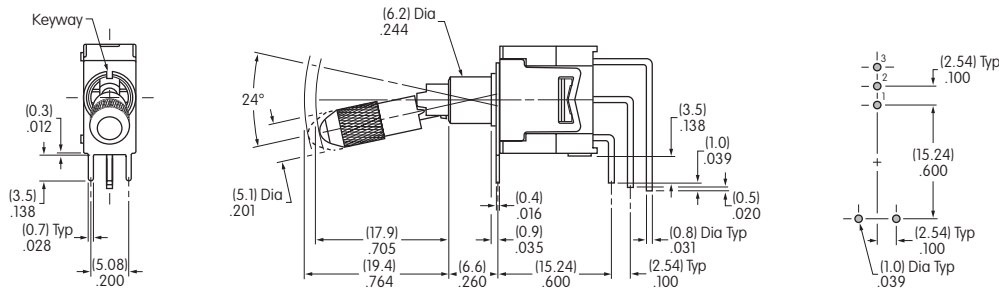

D22012LV

Actuator in Down Position

Vertical PC • Double Pole

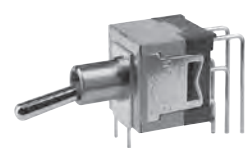
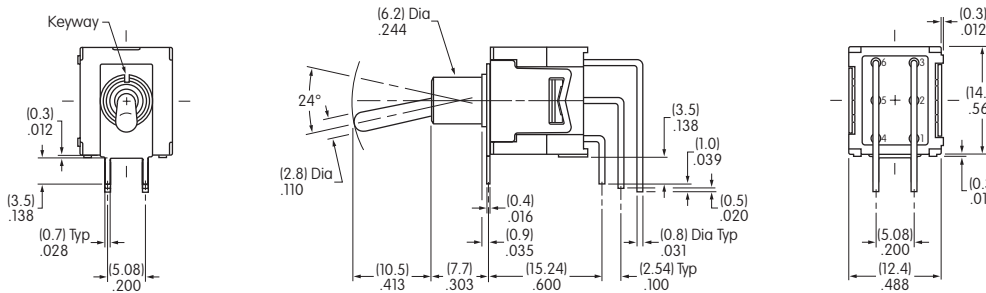

D22022V

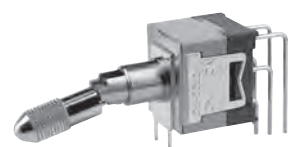
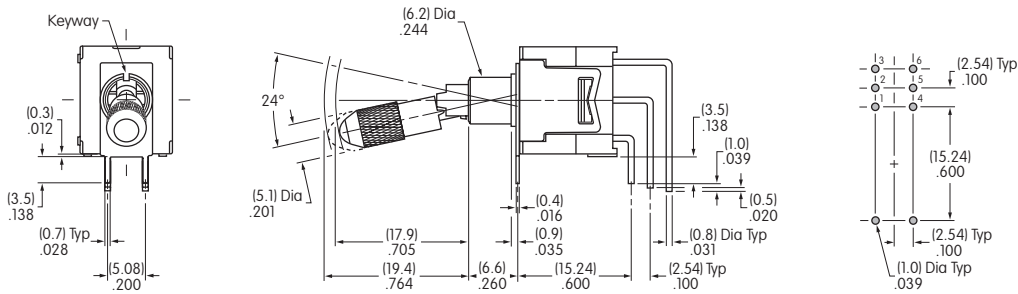

D22022LV

Actuator in Down Position

- A Toggles
- Rockers
- Pushbuttons
- Illuminated PB
- Programmable
- Key locks
- Rotaries
- Slides
- Tactiles
- Tilt
- Touch
- Indicators
- Accessories
- Supplement

## TYPICAL SWITCH DIMENSIONS

### Vertical PC • Four Pole

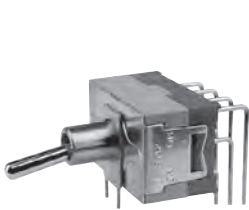

**D22042V**

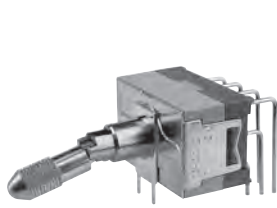
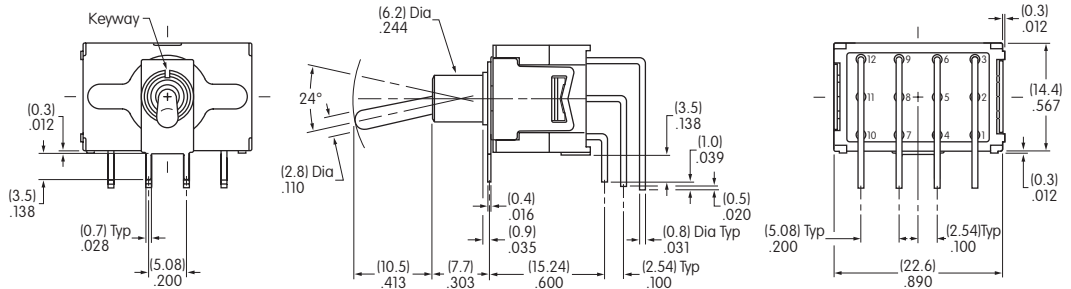

**D22042LV**

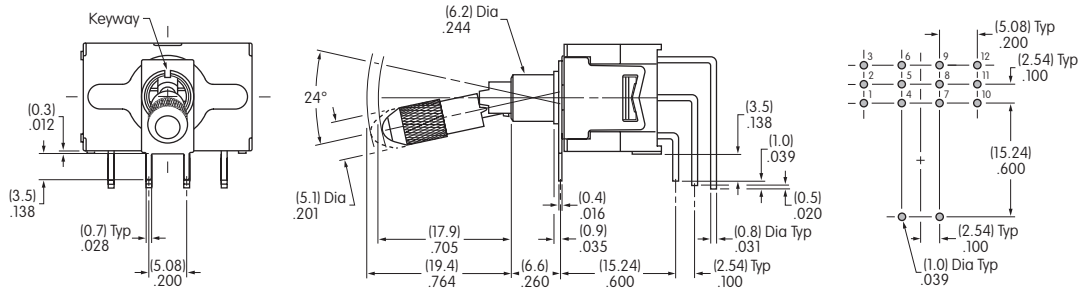

Actuator in Down Position

### STANDARD HARDWARE

### OPTIONAL

**AT513M Hex Nut**  
Brass with nickel plating  
2 supplied

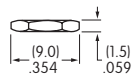
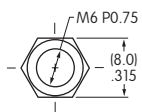

**AT507M Locking Ring**  
Steel with zinc/chromate  
1 supplied

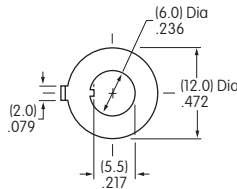

**AT509 Lockwasher**  
Steel with zinc/chromate  
1 supplied

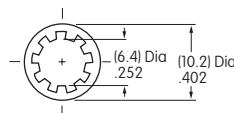

**AT501M Knurled Face Nut**  
Brass with chrome plating

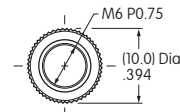

### PANEL CUTOUTS & MAXIMUM PANEL THICKNESS

**With Standard Hardware**

.087" (2.2mm) for Standard Lever

.051" (1.3mm) for Locking Lever

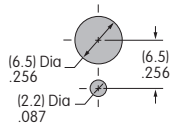

**Without Bottom Hex Nut**

.154" (3.9mm) for Standard Lever

.110" (2.8mm) for Locking Lever

**Without Locking Ring**

.118" (3.0mm) for Standard Lever

.083" (2.1mm) for Locking Lever

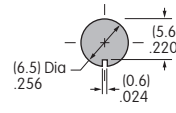

**Without Locking Ring & Bottom Hex Nut**

.185" (4.7mm) for Standard Lever

.142" (3.6mm) for Locking Lever



# General Specifications

## Electrical Capacity (Resistive Load)

**Logic Level:** 0.4VA maximum @ 28V AC/DC maximum  
(Applicable Range 0.1mA ~ 0.1A @ 20mV ~ 28V)  
Note: Find additional explanation of operating range in Supplement section.

## Other Ratings

**Contact Resistance:** 80 milliohms maximum  
**Insulation Resistance:** 500 megohms minimum @ 500V DC  
**Dielectric Strength:** 500V AC minimum for 1 minute minimum  
**Mechanical Life:** 100,000 operations minimum for On-None-On & On-Off-On  
50,000 operations minimum for other circuits  
**Electrical Life:** 100,000 operations minimum for On-None-On & On-Off-On  
50,000 operations minimum for other circuits

**Nominal Operating Force:** 0.93N for momentary & 1.20N for maintained  
**Angle of Throw:** 28°

## Materials & Finishes

**Actuator:** Glass fiber reinforced polyamide  
**Case:** Glass fiber reinforced polyamide  
**Sealing Rings:** Nitrile butadiene rubber  
**Movable Contacts:** Phosphor bronze with gold plating  
**Stationary Contacts:** Phosphor bronze with gold plating  
**Base:** Glass fiber reinforced polyamide  
**Terminals:** Phosphor bronze with gold plating  
**Support Bracket:** Phosphor bronze with tin plating

## Environmental Data

**Operating Temperature Range:** -25°C through +85°C (-13°F through +185°F)  
**Humidity:** 90 ~ 95% humidity for 96 hours @ 40°C (104°F)  
**Vibration:** 10 ~ 55Hz with peak-to-peak amplitude of 1.5mm traversing the frequency range & returning in 1 minute; 3 right angled directions for 2 hours  
**Shock:** 50G (490m/s<sup>2</sup>) acceleration (tested in 6 right angled directions, with 5 shocks in each direction)

## PCB Processing

**Soldering:** Wave Soldering recommended: See Profile A in Supplement section.  
Manual Soldering: See Profile A in Supplement section.  
**Cleaning:** Automated cleaning. See Cleaning specifications in Supplement section.

## Standards & Certifications

The G Series toggles have not been tested for UL recognition or CSA certification. These switches are designed for use in a low-voltage, low-current, logic-level circuit. When used as intended in a logic-level circuit, the results do not produce hazardous energy.

# Distinctive Characteristics

Ultra-miniature size allows high density mounting, and extremely light weight of 0.25 gram makes these switches ideal for handheld equipment.

Totally sealed body construction prevents contact contamination and allows time- and money-saving automated soldering and cleaning.

Molded-in, epoxy sealed terminals lock out flux, solvents, and other contaminants.

Award-winning STC contact mechanism with benefits unavailable in conventional mechanisms: smooth, positive detent actuation, increased contact stability, and unparalleled logic-level reliability. (Additional STC details in Terms & Acronyms; see Supplement section.)

.100" x .100" (2.54mm x 2.54mm) terminal spacing conforms to standard PC board grid spacing. Round terminals facilitate easier through-hole mounting on PC boards.

Matching indicators available.

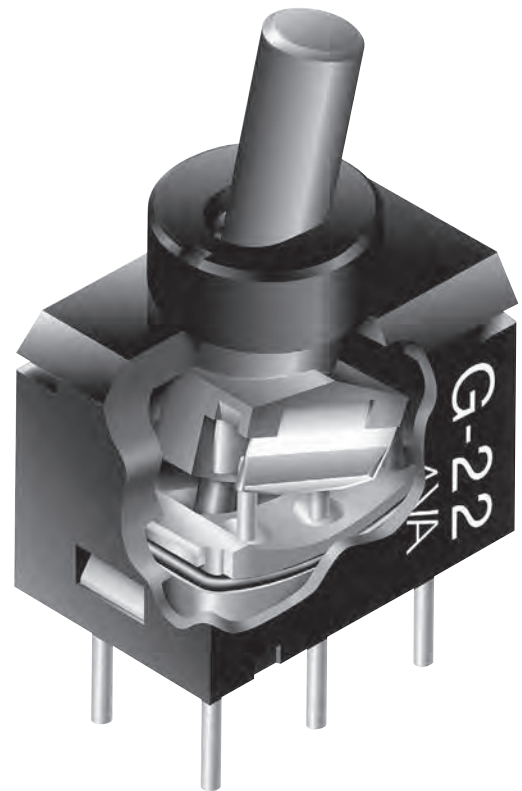

Actual Size

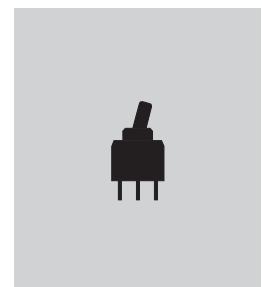

### TYPICAL SWITCH ORDERING EXAMPLE

<b>G</b>	<b>1</b>	<b>3</b>	<b>A</b>	<b>H</b>
<b>Poles</b>	<b>Circuits</b>			<b>Actuator</b>
1   SPDT	2   ON   NONE   ON	3   ON   OFF   ON	A   .150" (3.8mm) Column Toggle	<b>PC Terminals</b>
2   DPDT	5   ON   NONE   (ON)	8   (ON)   OFF   (ON)		P   Straight
	9   ON   OFF   (ON)			H   Right Angle
	( ) = Momentary			V   Vertical

### DESCRIPTION FOR TYPICAL ORDERING EXAMPLE

**G13AH**



### POLES & CIRCUITS

Pole	Model	Toggle Position ( ) = Momentary			Connected Terminals			Throw & Schematics
		Up	Center	Down	Up	Center	Down	
SP	G12 G13 G15 G18 G19	ON ON ON (ON) ON	NONE OFF NONE OFF OFF	ON ON (ON) (ON) (ON)	5-6	OPEN	5-4	SPDT 
DP	G22 G23 G25 G28 G29	ON ON ON (ON) ON	NONE OFF NONE OFF OFF	ON ON (ON) (ON) (ON)	5-6 2-3	OPEN	5-4 2-1	DPDT 

### ACTUATOR

**A** .150" (3.8mm) Column Toggle

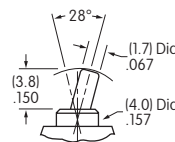



PC TERMINALS

A  
Toggles

**P** Straight

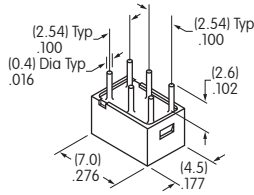

**H** Right Angle

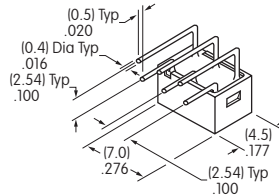

**V** Vertical

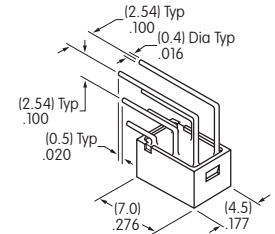

Rockers

Pushbuttons

Illuminated PB

TYPICAL SWITCH DIMENSIONS

Single & Double Pole

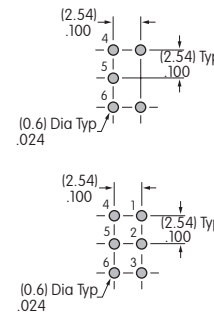
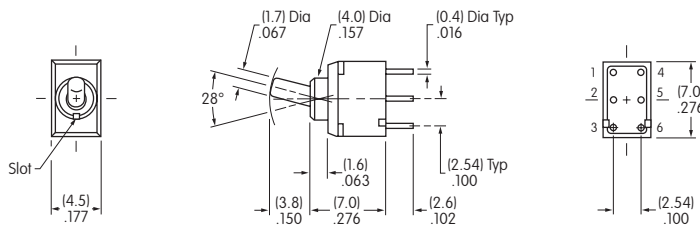

Straight PC



G19AP

Programmable

Keylocks

Rotaries

On single pole models, locations 1 & 3 are for support pins.

Single & Double Pole

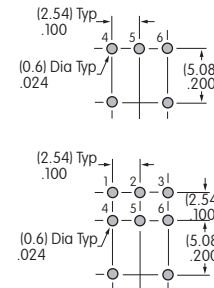
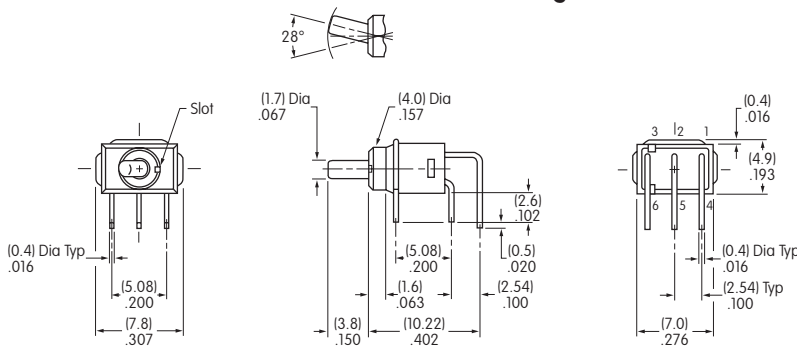

Right Angle PC



G19AH

Slides

Tactiles

Tilt

Single & Double Pole

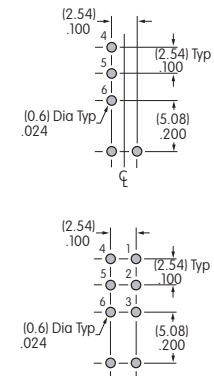
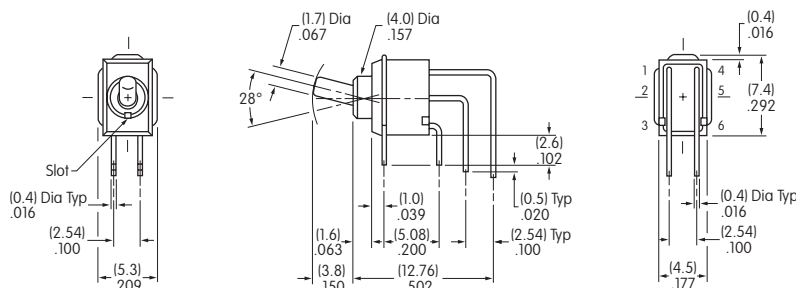

Vertical PC



G22AV

Touch

Indicators

Accessories

Supplement

## General Specifications

**Electrical Capacity (Resistive Load)**

**Logic Level:** 0.4VA maximum @ 28V AC/DC maximum  
(Applicable Range 0.1 mA ~ 0.1A @ 20mV ~ 28V)  
Note: Find additional explanation of operating range in Supplement section.

**Other Ratings**

**Contact Resistance:** 80 milliohms maximum  
**Insulation Resistance:** 500 megohms minimum @ 500V DC  
**Dielectric Strength:** 500V AC minimum for 1 minute minimum  
**Mechanical Life:** 100,000 operations minimum  
**Electrical Life:** 100,000 operations minimum  
10,000 operations minimum @ 0.1A @ 28V AC/DC  
**Nominal Operating Force:** 1.30N  
**Angle of Throw:** 28°

**Materials & Finishes**

**Actuator:** Polyamide  
**Case:** Glass fiber reinforced polyamide  
**Sealing Rings:** Nitrile butadiene rubber  
**Movable Contacts:** Phosphor bronze with gold plating  
**Stationary Contacts:** Phosphor bronze with gold plating  
**Base:** Glass fiber reinforced polyamide  
**Power Terminals:** Phosphor bronze with gold plating  
**Lamp Terminals:** Phosphor bronze with gold plating

**Environmental Data**

**Operating Temperature Range:** -25°C through +55°C (-13°F through +131°F)  
**Humidity:** 90 ~ 95% humidity for 240 hours @ 40°C (104°F)  
**Vibration:** 10 ~ 500Hz with peak-to-peak amplitude of 1.5mm traversing the frequency range & returning in 1 minute; 3 right angled directions for 2 hours  
**Shock:** 50G (490m/s<sup>2</sup>) acceleration (tested in 6 right angled directions, with 5 shocks in each direction)

**PCB Processing**

**Soldering:** Wave Soldering recommended. See Profile A in Supplement section.  
Manual Soldering: See Profile A in Supplement section.  
**Cleaning:** Automated cleaning. See Cleaning specifications in Supplement section.

**Standards & Certifications**

The G Series toggles have not been tested for UL recognition or CSA certification. These switches are designed for use in a low-voltage, low-current, logic-level circuit. When used as intended in a logic-level circuit, the results do not produce hazardous energy.

# Distinctive Characteristics

Fully illuminated toggle for highly visible status indication with LED in red, green, or amber for single color and red/green for bicolor.

Ultra-miniature size allows high density mounting, and extremely light weight makes these switches ideal for handheld equipment.

Totally sealed body construction prevents contact contamination and allows time- and money-saving automated soldering and cleaning.

Molded-in, epoxy sealed terminals lock out flux, solvents, and other contaminants.

Award-winning STC contact mechanism with benefits unavailable in conventional mechanisms: smooth, positive detent actuation, increased contact stability, and unparalleled logic-level reliability. (Additional STC details in Terms & Acronyms; see Supplement section.)

.100" x .100" (2.54mm x 2.54mm) terminal spacing conforms to standard PC board grid spacing. Round terminals facilitate easier through-hole mounting on PC boards.

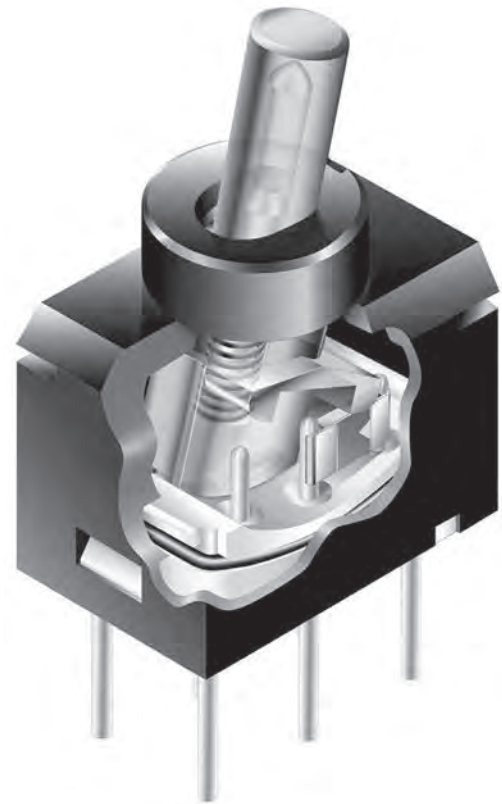

Actual Size

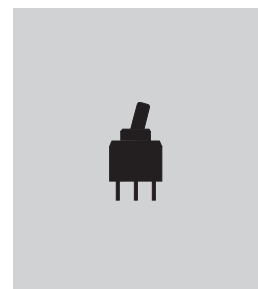

A

Toggles

Rockers

Pushbuttons

Illuminated PB

Programmable

Key locks

Rotaries

Slides

Tactiles

Tilt

Touch

Indicators

Accessories

Supplement

### TYPICAL SWITCH ORDERING EXAMPLE

<b>G</b>	<b>1</b>	<b>2</b>	<b>J</b>	<b>H</b>	<b>C</b>	
<b>Pole</b>	<b>Circuits</b>			<b>Actuator</b>	<b>PC Terminals</b>	<b>LEDS</b>
1   SPDT	2   ON   NONE   ON	J   Clear			P   Straight	<b>Single Color</b>
	Combines with single color or bicolor LEDs				H   Right Angle	C   Red
	3   ON   OFF   ON				V   Vertical	D   Amber
	Combines with bicolor LED only					F   Green
						ON-NONE-ON only
						<b>Bicolor</b>
						CF   Red/Green
						ON-NONE-ON & ON-OFF-ON

**DESCRIPTION FOR TYPICAL ORDERING EXAMPLE**  
**G12JHC**

SPDT  
ON-NONE-ON Circuit  
Clear Toggle, Red LED

Right Angle PC Terminals

### POLES & CIRCUITS

Pole Throw	Model	Toggle Position			Connected Terminals			Schematics	
		Up	Center	Down	Up	Center	Down		
SPDT	<b>G12</b> <b>G13</b>	ON ON	NONE OFF	ON ON	2-3 2-3	NONE OPEN	2-1 2-1		

Note: Terminal numbers are not actually on the switch. LED circuit is isolated and requires an external power source.

### ACTUATOR

**J** Clear Toggle

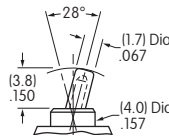

### LED COLORS & SPECIFICATIONS

	Colors	Single Color			Bicolor
		<b>C</b> Red	<b>D</b> Amber	<b>F</b> Green	<b>CF</b> Red/Green
LEDs are an integral part of the switch and not available separately. The electrical specifications shown are determined at a basic temperature of 25°C.					
Maximum Forward Current	$I_{FM}$	30mA	30mA	25mA	30mA/25mA
Typical Forward Current	$I_F$	20mA	20mA	20mA	20mA/20mA
Forward Voltage	$V_F$	2.0V	2.0V	2.1V	2.0V/2.1V
Maximum Reverse Voltage	$V_{RM}$	5V	5V	5V	5V/5V
Current Reduction Rate Above 25°C	$\Delta I_F$	0 - No current Reduction Rate within Ambient Temperature Range			
Ambient Temperature Range		-25° ~ +55°C			

If the source voltage exceeds the rated voltage, a ballast resistor is required.

The resistor value can be calculated by using the formula in the Supplement; see Supplement Index.

## PC TERMINALS

A  
Toggles

**P**

**Straight**

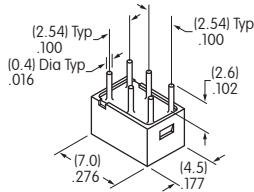

**H**

**Right Angle**

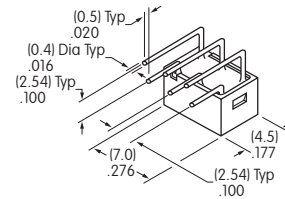

**V**

**Vertical**

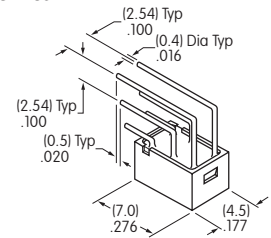

Rockers

Pushbuttons

Illuminated PB

## TYPICAL SWITCH DIMENSIONS

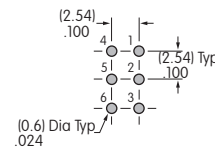
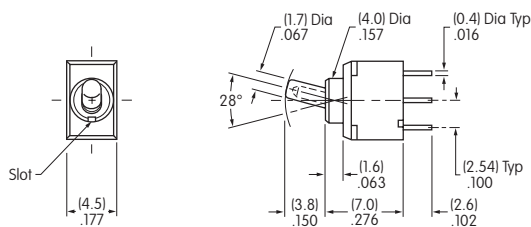

**Straight PC**



5 & 6 are LED terminals; 4 is a support pin on single color models & an LED terminal on bicolor models.

**G12JPC**

Programmable

Keylocks

Rotaries

Slides

**Right Angle PC**

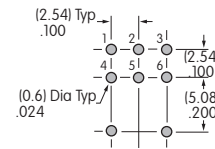
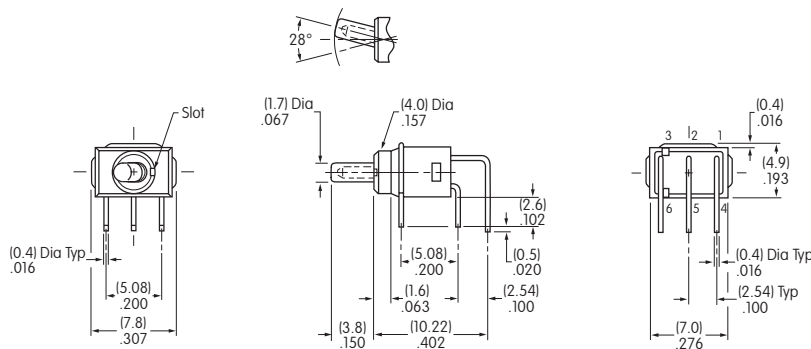

5 & 6 are LED terminals; 4 is a support pin on single color models & an LED terminal on bicolor models.

**G12JHD**

Tactiles

Tilt

Touch

**Vertical PC**

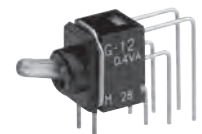
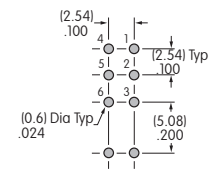
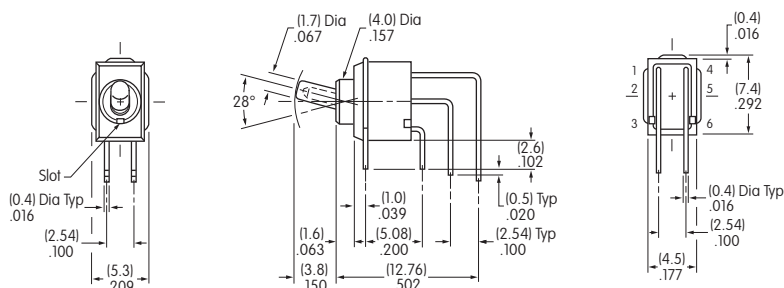

5 & 6 are LED terminals; 4 is a support pin on single color models & an LED terminal on bicolor models.

**G12JVC**

Indicators

Accessories

Supplement

# General Specifications

## Electrical Capacity (Resistive Load)

**Logic Level:** 0.4VA maximum @ 28V AC/DC maximum  
(Applicable Range 0.1mA ~ 0.1A @ 20mV ~ 28V)  
Note: See Supplement section for explanation of operating range.

## Other Ratings

**Contact Resistance:** 80 milliohms maximum  
**Insulation Resistance:** 500 megohms minimum @ 500V DC  
**Dielectric Strength:** 500V AC minimum for 1 minute minimum  
**Mechanical Life:** 50,000 operations minimum  
**Electrical Life:** 50,000 operations minimum  
**Nominal Operating Force:** 1.6N for momentary & 1.7N for maintained  
**Angle of Throw:** 28°

## Materials & Finishes

**Actuator:** Polyphenylene sulfide (UL94V-0)  
**Case:** Polyphenylene sulfide (UL94V-0)  
**Sealing Rings:** Nitrile butadiene rubber  
**Movable Contacts:** Phosphor bronze with gold plating  
**Stationary Contacts:** Phosphor bronze with gold plating  
**Base:** Polyphenylene sulfide (UL94V-0)  
**Terminals:** Phosphor bronze with gold plating

## Environmental Data

**Operating Temperature Range:** -30°C through +85°C (-22°F through +185°F)  
**Humidity:** 90 ~ 95% humidity for 96 hours @ 40°C (104°F)  
**Vibration:** 10 ~ 500Hz with peak-to-peak amplitude of 1.5mm traversing the frequency range & returning in 1 minute; 3 right angled directions for 2 hours  
**Shock:** 50G (490m/s<sup>2</sup>) acceleration (tested in 6 right angled directions, with 5 shocks in each direction)

## Installation

**Mounting:** It is recommended that the body of models for upright mounting without bracket be fastened to a panel or similar support for protection of solder joints from mechanical stress.  
**Coplanarity:** See specifications in Terms & Acronyms in Supplement section

## Processing

**Soldering:** Reflow Soldering recommended. See Profile B in Supplement section.  
Manual Soldering: See Profile B in Supplement section.  
**Cleaning:** Automated cleaning. See Cleaning specifications in Supplement section.

## Standards & Certifications

**Flammability Standard:** UL94V-0 actuator, case & base  
The G3T Series toggles have not been tested for UL recognition or CSA certification. These switches are designed for use in a low-voltage, low-current, logic-level circuit. When used as intended in a logic-level circuit, the results do not produce hazardous energy.

# Distinctive Characteristics

Ultra-miniature size allows high density mounting, and extremely light weight of 0.6 gram makes these switches ideal for handheld equipment.

Tape-reel and stick-tube packaging allow rapid automated placement of surface mount devices. Tape-reel packaging meets EIA-481-D Standard.

Heat resistant resin used for housing, base, and lever allows vapor phase and infrared convection reflow soldering.

Combination of design features achieves total seal and allows automated processing techniques, including flux cleaning procedures: one-piece bushing and housing, rubber seals surrounding actuator and base, epoxy at joint of case and base, and molded-in, epoxy-sealed terminals.

Award-winning STC contact mechanism with benefits unavailable in conventional mechanisms: smoother, positive detent actuation, increased contact stability and unparalleled logic-level reliability. (Additional STC details in Terms & Acronyms; see Supplement section.)

Gull-wing terminals provide mechanical stability during soldering and simplified solder joint inspection.

Coplanarity: all considered surfaces must lie between two parallel planes that are a maximum distance apart of .0059" (0.15mm). (Additional coplanarity details in Terms and Acronyms in the Supplement section.)

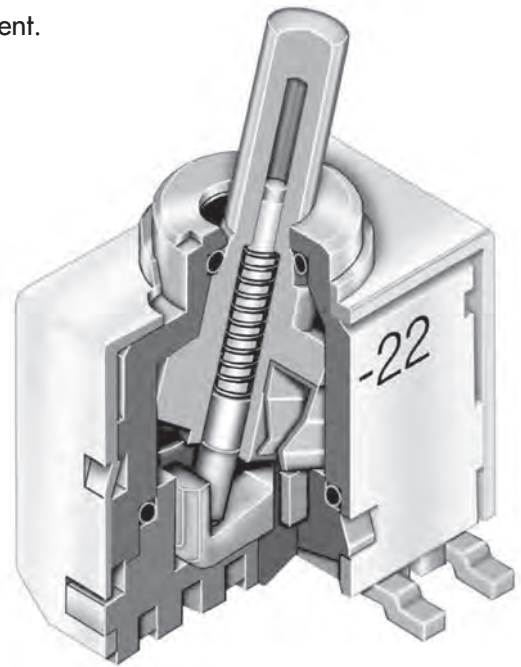

Actual Size

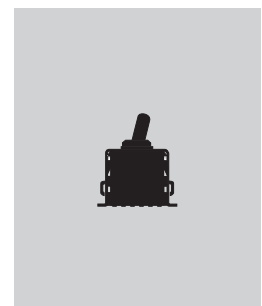

- A Toggles
- Rockers
- Pushbuttons
- Illuminated PB
- Programmable
- Key locks
- Rotaries
- Slides
- Tactiles
- Tilt
- Touch
- Indicators
- Accessories
- Supplement

### TYPICAL SWITCH ORDERING EXAMPLE

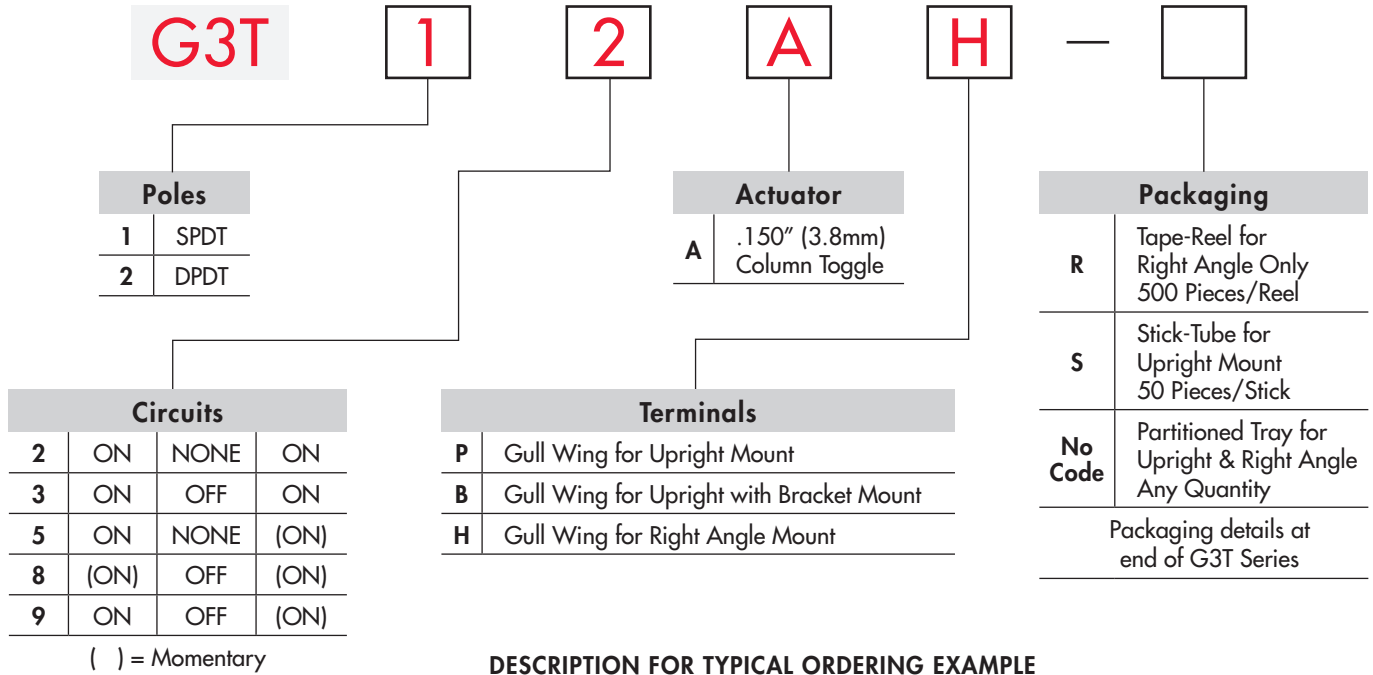

### DESCRIPTION FOR TYPICAL ORDERING EXAMPLE

#### G3T12AH



### POLES & CIRCUITS

Pole	Model	Toggle Position ( ) = Momentary			Connected Terminals			Throw & Schematics
		Up	Center	Down	Up	Center	Down	
SP	G3T12 G3T13 G3T15 G3T18 G3T19	ON ON ON (ON) ON	NONE OFF NONE OFF OFF	ON ON (ON) (ON) (ON)	5-6	OPEN	5-4	SPDT 
DP	G3T22 G3T23 G3T25 G3T28 G3T29	ON ON ON (ON) ON	NONE OFF NONE OFF OFF	ON ON (ON) (ON) (ON)	5-6 2-3	OPEN	5-4 2-1	DPDT 

Note: Terminal numbers are not actually on switch.

### ACTUATOR

**A** .150" (3.8mm) Column Toggle

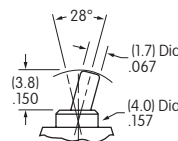



TYPICAL SWITCH DIMENSIONS

Single & Double Pole

Upright Mounting

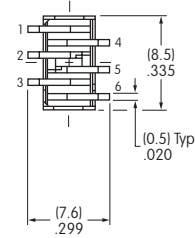
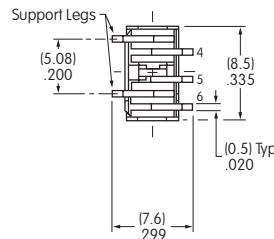
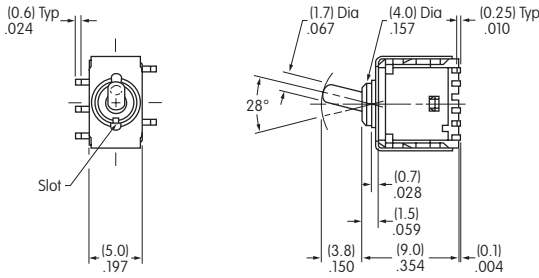

G3T12AP

Single & Double Pole

Upright Mounting with Bracket

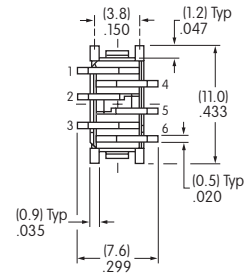
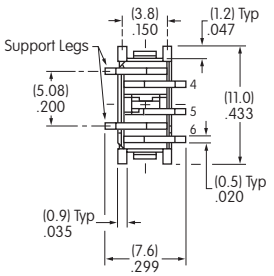
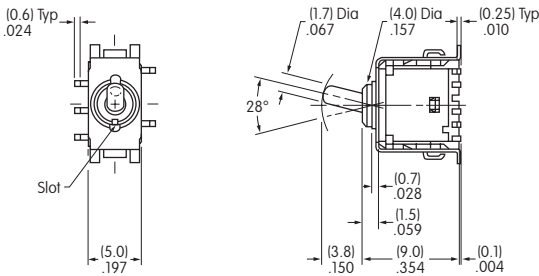

G3T22AB

Right Angle Mounting

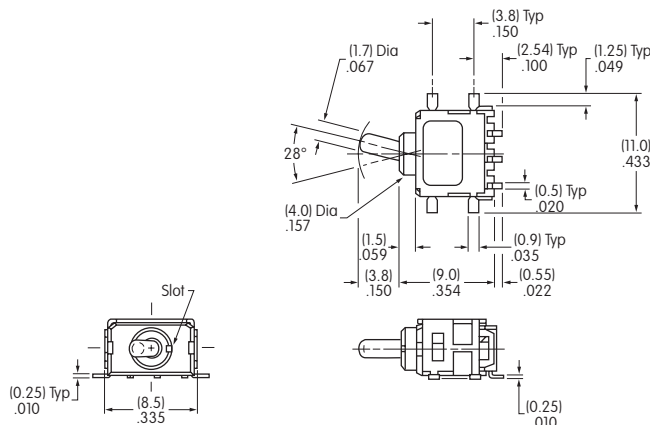

Single Pole

Double Pole

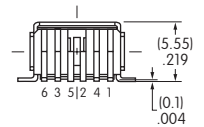
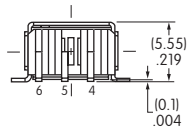

G3T12AH

Pad Layouts for Surface Mount Terminals

Upright Mounting

Upright Mounting with Bracket

Right Angle Mounting

Single Pole Double Throw

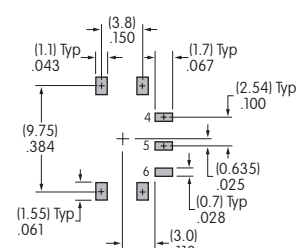
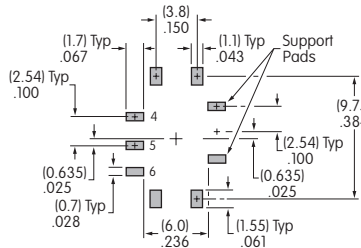
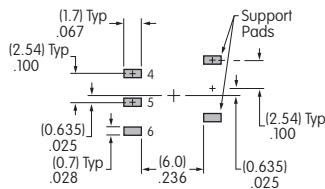

Double Pole Double Throw

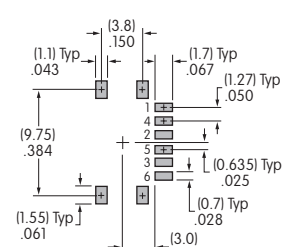
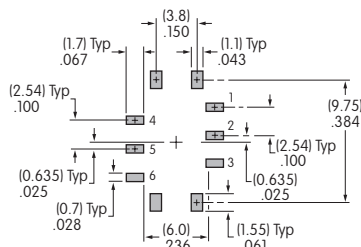
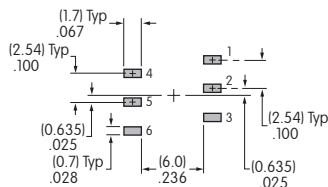

### PACKAGING

#### **R** Tape-Reel for Right Angle

500 pieces per reel

Switches must be ordered in 500-piece increments when tape-reel packaging is selected.

This packaging meets EIA-481-D Standard for "16mm and 24mm Embossed Carrier Taping of Surface Mount Components for Automatic Handling."



#### **S** Stick-Tube for Upright Mount

50 pieces per stick

Switches must be ordered in 50-piece increments when stick-tube packaging is selected.



#### **No Code** Partitioned Tray for Upright & Right Angle

Any quantity

If the G3 upright models are ordered in less than 50-piece increments or the right angle models in less than 500-piece increments, the switches are packaged in a partitioned tray. No code is required.



PACKAGING (CONTINUED)

Tape-Reel Packaging for Right Angle Mount

Each tape-reel of 550 pockets contains 500 switches.

Minimum Leader Length: 7.87" (200mm) Minimum Trailer Length: 1.97" (50mm)

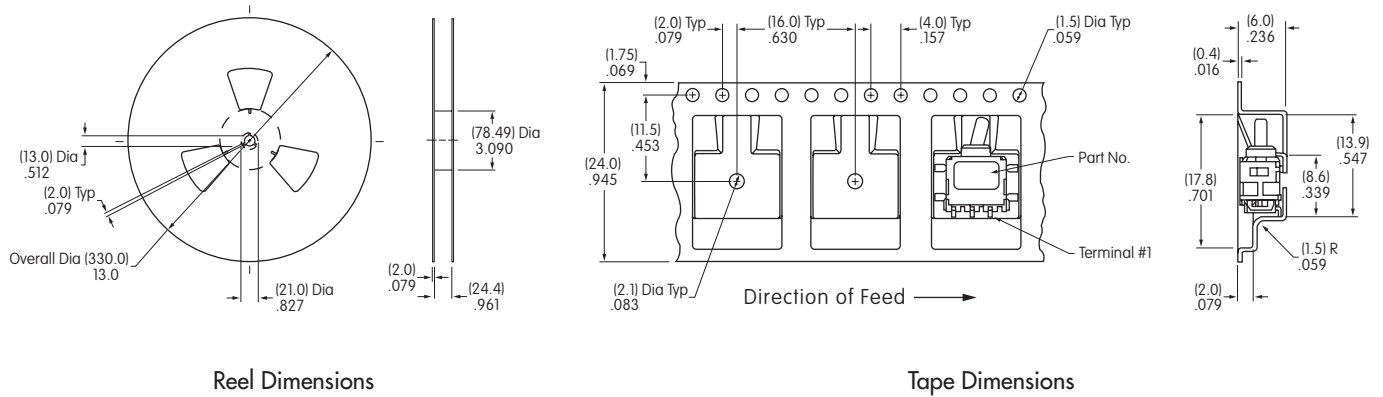

Reel Dimensions

Tape Dimensions

Stick-Tube Packaging for Upright Mount

Each stick-tube contains 50 switches.

L = Length

G3T Upright (code P)  
18.31" (465mm)

G3T Upright with Bracket (code B)  
21.26" (540mm)

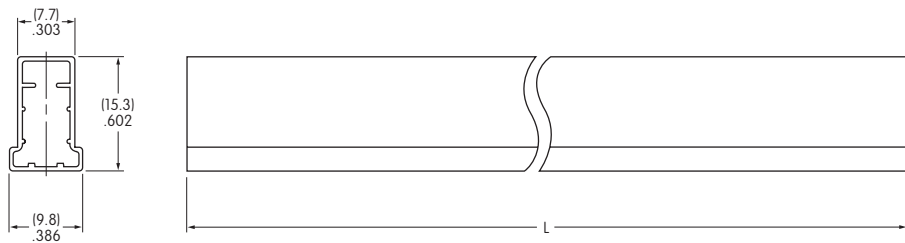

Stick-Tube Dimensions

# A General Specifications

### Electrical Capacity (Resistive Load)

**Power Level (silver):** 6A @ 125V AC & 3A @ 250V AC  
4A @ 30V DC for On-None-On; 3A @ 30V DC for all other circuits

**Logic Level (gold):** 0.4VA maximum @ 28V AC/DC maximum (Applicable Range 0.1mA ~ 0.1A @ 20mV ~ 28V)

### Other Ratings

**Contact Resistance:** 10 milliohms maximum for silver; 20 milliohms maximum for gold

**Insulation Resistance:** 1,000 megohms minimum @ 500V DC

**Dielectric Strength:** 1,000V AC minimum between contacts for 1 minute minimum;  
1,500V AC minimum between contacts and case for 1 minute minimum

**Mechanical Life:** 50,000 operations minimum

**Electrical Life:** 50,000 operations minimum for silver at 3A @ 250V AC; 25,000 operations minimum for silver at 6A @ 125V AC; 50,000 operations minimum for gold

**Angle of Throw:** 25°

### Environmental Data

**Operating Temp Range:** -30°C through +85°C (-22°F through +185°F)

**Sealing:** Waterproofing, achieved with boot at base of lever plus o-rings inside and outside of bushing, meets IP67 of IEC60529 Standards (dust tight and protection against effects of temporary immersion). See further explanation on page A51.

### Processing

**Soldering:** Manual Soldering for Silver: ON-NONE-ON: See Profile B in Supplement section.  
ON-OFF-ON and (ON)-OFF-(ON): See Profile A in Supplement section.  
Manual Soldering for Gold, all circuits: See Profile A in Supplement section.  
Note: Lever must be in OFF (center) position while soldering.

# Distinctive Characteristics

Inner o-ring and external rubber washer seal the switch to achieve IP67 of IEC60529 Standards (dust tight and water protected for temporary immersion).

Waterproof boot at base of toggle further ensures protection against wet environments.

Actual Size

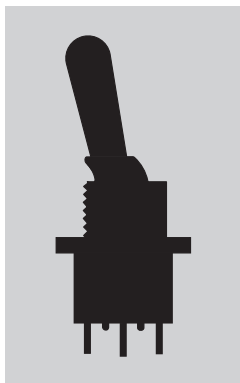

Actuation provides smooth, sturdy tactile feel.

Polished, chrome-plated actuator paired with the waterproof boot not only delivers in terms of sleek design, but also functionality and reliability.

Superb quality and construction design prohibit entry of harmful particles that may otherwise compromise lever operation.

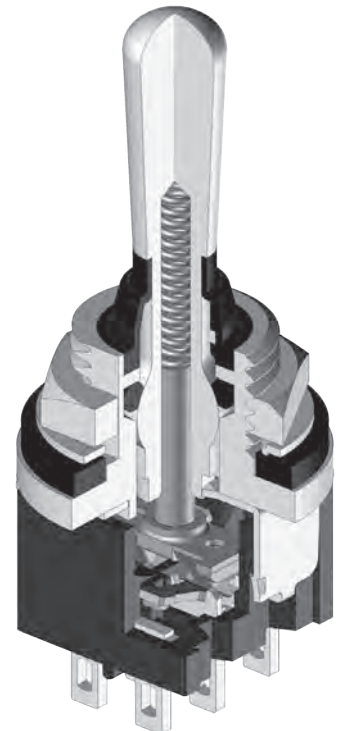

## TYPICAL SWITCH ORDERING EXAMPLE

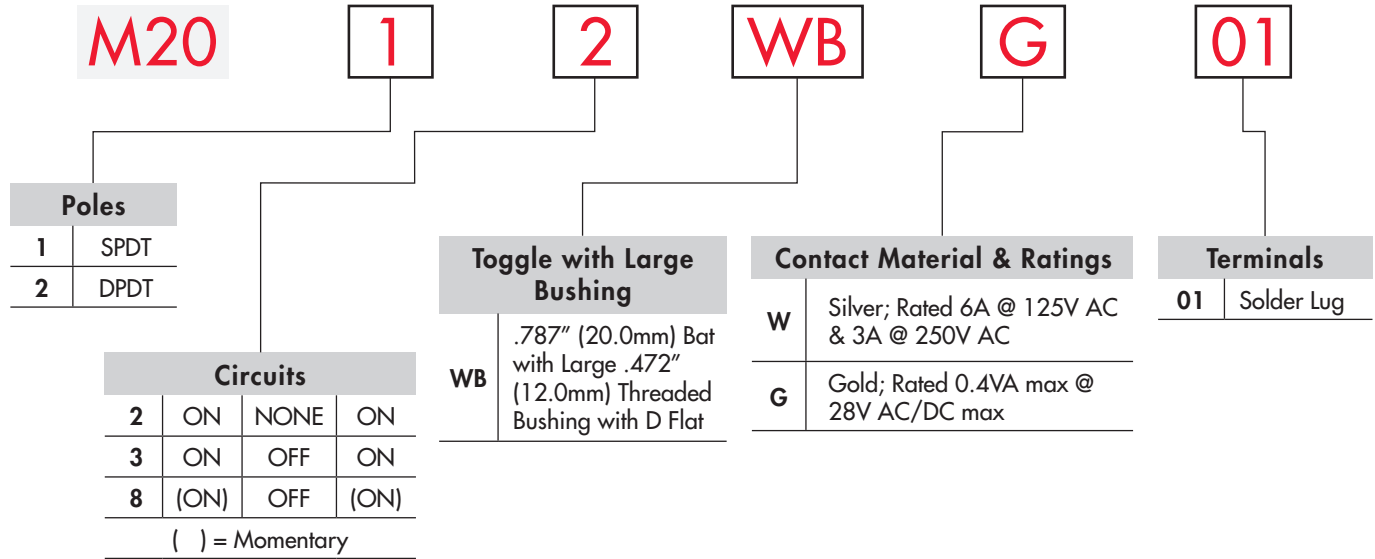

### DESCRIPTION FOR TYPICAL ORDERING EXAMPLE

#### M2012WBG01

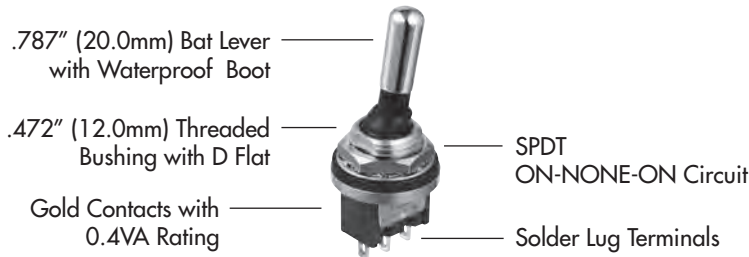

### POLES & CIRCUITS

Pole	Model	Toggle Position ( ) = Momentary			Connected Terminals			Throw & Schematics
		Up	Center	Down	Up	Center	Down	
SP	M2012 M2013 M2018	ON ON (ON)	NONE OFF OFF	ON ON (ON)	2-3 Flat	OPEN	2-1	Note: Terminal numbers are not actually on the switch. 
DP	M2022 M2023 M2028	ON ON (ON)	NONE OFF OFF	ON ON (ON)	2-3 5-6 Flat	OPEN	2-1 5-4	

## STANDARD HARDWARE

**AT503M Hex Face Nut**  
Brass/Chrome

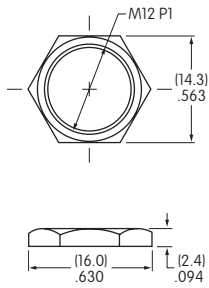

**AT508 Lockwasher**  
Steel with Zinc/Chromate

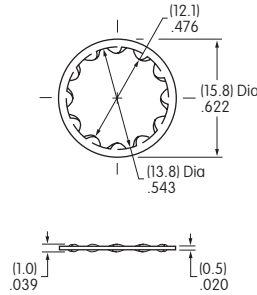

**AT401P O-ring**  
Nitrile Butadiene Rubber

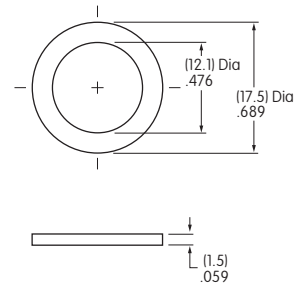

## PANEL CUTOUTS & THICKNESS

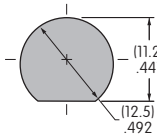

Anti-rotation

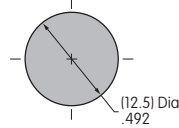

No  
Anti-rotation

Maximum Effective Panel Thickness  
.138" (3.5mm)

## TYPICAL SWITCH DIMENSIONS

**Solder Lug**

**Single Pole**

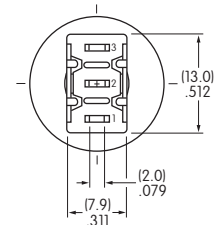
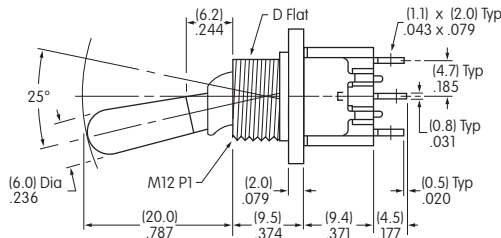
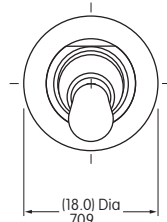

**M2012WBG01**

**Solder Lug**

**Double Pole**

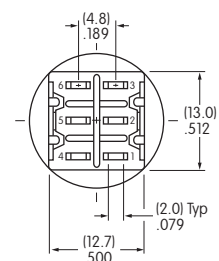
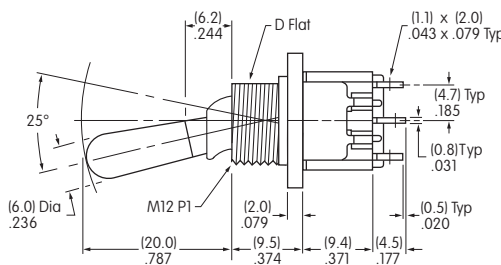
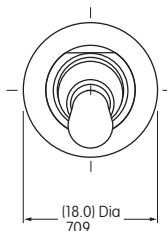

**M2022WBG01**

## APPLICATION CONSIDERATIONS

The Dual Seal Waterproof M Toggle is designed as a panel seal switch, and not to be used under water.

### Material Properties

The material for the waterproof boot is silicone rubber. While silicone rubber has excellent heat, cold and weather resistant properties, it has less durability and oil resistance.

The o-rings are made of nitrile butadiene rubber, which excels in durability and oil and chemical resistance. Its performance is less durable with lower weather and ozone resistant characteristics.

Evaluate the products in regard to your application and intended environment with these properties in mind.

### Waterproof Test Conditions

Waterproofing is measured by submersing the switch 5 centimeters from the water surface (see illustration), and opening and closing 50 times at a frequency of 50 – 60 times per minute. The switch is then submersed 1 meter from the surface and left in this position for 30 minutes.

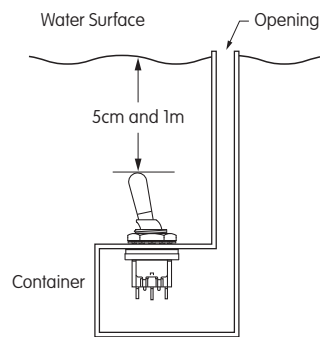

Repeat opening and closing same as previous test. The resulting insulation resistance and voltage capacity are both within the rated values, and water has not entered inside the switch or installation panel.

### Panel Installation

For panel installation, the internal tooth lockwasher is installed above the panel. The external o-ring mounts below the panel.

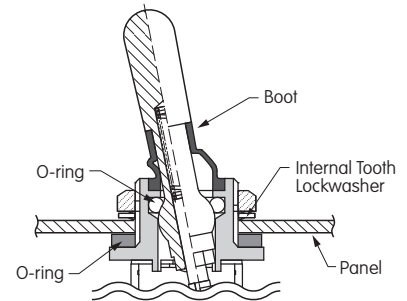

### Applications

- Construction Equipment
- Hospitality and Restaurant
- Transportation
- Medical Equipment
- Machine Tooling
- Marine Equipment \*

\* Salt spray tested as per Mil-STD-810G section 509.5.

A  
Toggles

Rockers

Pushbuttons

Illuminated PB

Programmable

Key locks

Rotaries

Slides

Tactiles

Tilt

Touch

Indicators

Accessories

Supplement

# General Specifications

## Electrical Capacity (Resistive Load)

- Power Level (silver):** 6A @ 125V AC & 3A @ 250V AC  
4A @ 30V DC for On-None-On & On-None-Off; 3A @ 30V DC for all other circuits
- Logic Level (gold):** 0.4VA maximum @ 28V AC/DC maximum (Applicable Range 0.1mA ~ 0.1A @ 20mV ~ 28V)
- Logic/Power Level (gold over silver):** Combines silver & gold ratings  
Note: Find additional explanation of dual rating & operating range in Supplement section.

## Other Ratings

- Contact Resistance:** 10 milliohms maximum for silver; 20 milliohms maximum for gold
- Insulation Resistance:** 1,000 megohms minimum @ 500V DC
- Dielectric Strength:** 1,000V AC minimum between contacts for 1 minute minimum;  
1,500V AC minimum between contacts and case for 1 minute minimum
- Mechanical Life:** 100,000 operations minimum; 50,000 operations minimum for flat, locking & splashproof devices
- Electrical Life:** 25,000 operations minimum for silver; 50,000 operations minimum for gold;  
50,000 operations minimum for silver at 3A @ 125V AC
- Angle of Throw:** 25°

## Materials & Finishes

- Toggle:** Brass with chrome plating
- Bushing:** Brass with nickel plating
- Case:** Diallyl phthalate resin (UL94V-0)
- Movable Contactor:** Phosphor bronze with silver or gold plating
- Movable Contacts:** Silver alloy (code W); copper with gold plating (code G); or silver alloy with gold plating (code A)
- Stationary Contacts:** Silver with silver plating (code W); copper or brass with gold plating (code G);  
or silver with gold plating (code A)
- Terminals:** Copper or brass with silver plating; or copper or brass with gold plating
- Frame:** Stainless steel
- Support Bracket:** Brass with tin plating

## Environmental Data

- Operating Temp Range:** -30°C through +85°C (-22°F through +185°F)
- Humidity:** 90 ~ 95% humidity for 96 hours @ 40°C (104°F)
- Vibration:** 10 ~ 55Hz with peak-to-peak amplitude of 1.5mm traversing the frequency range & returning in 1 minute; 3 right angled directions for 2 hours
- Shock:** 50G (490m/s<sup>2</sup>) acceleration (tested in 6 right angled directions, with 5 shocks in each direction)
- Sealing:** Splashproof bushing options B3, D3, D8, L3, & L8, which have o-rings inside & outside the bushing, meet IP67 of IEC60529 Standards.

## Installation

- Mounting Torque:** 3.0Nm (26.55 lb•in) double nut for large bushing;  
1.5Nm (13 lb•in) double nut & 0.7Nm (6 lb•in) single nut for all other bushings

## Processing

- Soldering:** Wave Soldering (PC version) for Gold: See Profile A in Supplement section.  
Manual Soldering for Gold: See Profile A in Supplement section.  
Wave Soldering (PC version) for Silver: See Profile B in Supplement section.  
Manual Soldering for Silver: See Profile B in Supplement section.  
Note: Lever must be in OFF (center) position while soldering.
- Cleaning:** These devices are not process sealed. Hand clean locally using alcohol based solution.

## Standards & Certifications

- Flammability Standards:** UL94V-0 for case
- UL:** **File No. E44145 - Recognized only when ordered with marking on switch.**  
Add "/U" or "/CUL" before dash in part number to order UL recognized switch.  
All models recognized at 6A @ 125V AC, 3A @ 250V AC or 0.4VA maximum @ 28V DC maximum.
- CSA:** **File No. 023535\_0\_000 - Certified only when ordered with marking on switch.**  
Add "/C" before dash in part number to order CSA certified switch.  
All models certified at 6A @ 125V AC or 3A @ 250V AC or 0.4VA maximum @ 28V maximum.



# Distinctive Characteristics

Antirotation design, standard on noncylindrical levers, mates toggle and bushing; bottom of toggle has two flatted sides which fit into a complementary opening inside bushing.

Antijamming design protects contacts from damage due to excessive downward force on actuator.

High torque bushing construction prevents rotation or separation from frame during installation.

High insulating barriers increase isolation of circuits in multipole devices and provide added protection to contact points.

Molded diallyl phthalate case has a UL flammability rating of 94V-0.

Epoxy sealed terminals prevent entry of solder flux and other contaminants.

Prominent external insulating barriers increase insulation resistance and dielectric strength.

Interlocked actuator block, lever, and interior guide prevent switch failure due to biased lever movement.

Clinching of frame to case well above base and terminals provides 1,500V dielectric strength.

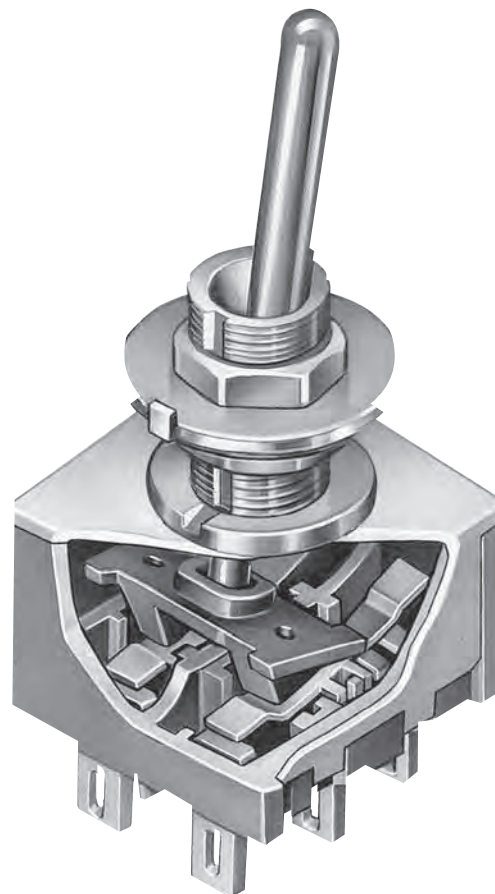

Actual Size

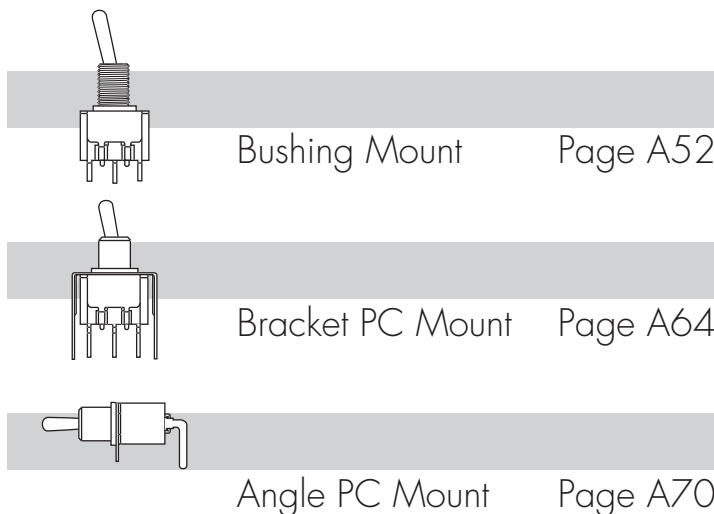
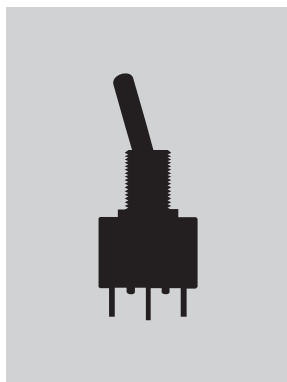

M20

1

3

S

S1

Poles	
1	SPST SPDT
2	DPST DPDT SP3T
3	3PDT
4	4PDT DP3T

Small Toggles	
S	.413" (10.5mm) Bat
S2	.200" (5.08mm) Bat
S3	.256" (6.5mm) Bat
E	.450" (11.4mm) Flatted
*E2	.256" (6.5mm) Flatted
E4	.840" (21.3mm) Flatted
*Q	.550" (14.0mm) Cone
*Q2	.640" (16.26mm) Cone
*Q4	.840" (21.3mm) Cone
*C	.571" (14.5mm) Color Tipped Cone (available in colors A, B & C only)
D	.840" (21.3mm) Color Capped Cone

Specify cap color for toggles C & D at the end of the part number.  
\* Available on 1- and 2-pole only.

Small Bushings	
S1	.350" (8.9mm) Threaded with Keyway
S4	6mm .350" (8.9mm) Threaded with Keyway
S2	.350" (8.9mm) Smooth with Keyway
A1	.280" (7.1mm) Threaded with Keyway
A2	.280" (7.1mm) Smooth with Keyway
D1	.350" (8.9mm) Threaded with D Flat
D4	6mm .350" (8.9mm) Threaded with D Flat
D3	.350" (8.9mm) Threaded Splashproof with D Flat (combines only with S, S2 & S3)
D8	6mm .350" (8.9mm) Threaded Splashproof with D Flat (combines only with S, S2 & S3)

Circuits			
*1	ON	NONE	OFF
2	ON	NONE	ON
3	ON	OFF	ON
5	ON	NONE	(ON)
8	(ON)	OFF	(ON)
9	ON	OFF	(ON)
**4	ON	ON	ON
**6	(ON)	ON	(ON)
**7	ON	ON	(ON)

Large Toggles	
B	.453" (11.5mm) Large Bat
B2	.689" (17.5mm) Large Bat
R	.610" (15.5mm) Large Flatted

Large Bushings	
B1	Large .472" (12mm) Threaded with Keyway
B3	Large .472" (12mm) Threaded Splashproof with D Flat

Locking Lever	
L	.201" (5.1mm) Dia. Locking Lever

Bushings For Locking Levers	
L1	.291" (7.4mm) Threaded with Keyway for Lever Lock
L4	6mm .291" (7.4mm) Threaded with Keyway for Lever Lock
L2	Smooth with Keyway for Lever Lock
L3	.295" (7.5mm) Threaded Splashproof with D Flat for Lever Lock
L8	6mm .295" (7.5mm) Threaded Splashproof with D Flat for Lever Lock

( ) = Momentary

\* ON-NONE-OFF circuit available in 1- and 2-pole only.

\*\* 3-ON circuits

#### IMPORTANT:

Switches are supplied without UL, cULus & CSA marking unless specified.  
**UL, cULus & CSA recognized only when ordered with marking on the switch.**  
 Specific models, ratings, & ordering instructions are noted on the General Specifications page.



## ORDERING EXAMPLE

Contact Materials & Ratings	
<b>W</b>	Silver; Rated 6A @ 125V AC & 3A @ 250V AC
<b>G</b>	Gold; Rated 0.4VA max @ 28V AC/DC max
<b>A</b>	Gold over Silver; Rated 6A @ 125V AC & 0.4VA max @ 28V AC/DC max

Terminals	
<b>01</b>	Solder Lug
<b>02</b>	Quick Connect
<b>03</b>	.250" (6.35mm) Straight PC
<b>05</b>	.425" (10.8mm) Wirewrap
<b>06</b>	.750" (19.05mm) Wirewrap
<b>07</b>	.964" (24.5mm) Wirewrap
<b>08</b>	1.062" (27.0mm) Wirewrap

Optional Caps	
For Small Bat Toggles	
<b>B</b>	For S Bat Toggle
<b>C</b>	Conical Cap for S Bat Toggle
For Large Bat Toggles	
<b>R</b>	For B Toggle
<b>V</b>	For B2 Toggle

Cap Colors	
<b>A</b>	Black
<b>B</b>	White
<b>C</b>	Red
<b>E</b>	Yellow
<b>F</b>	Green
<b>G</b>	Blue

Cap for Locking Lever	
<b>No Code</b>	Nickel Plated Supplied with Switch
<b>A</b>	Black
<b>C</b>	Red
<b>G</b>	Blue





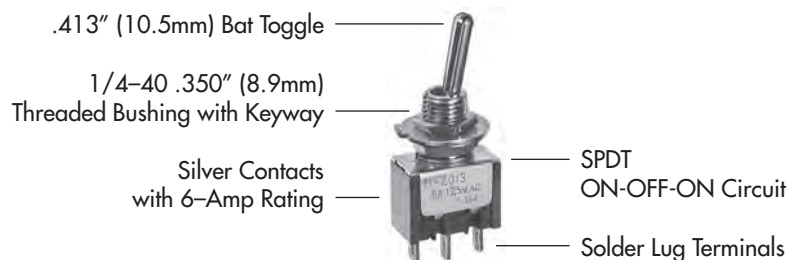





### DESCRIPTION FOR TYPICAL ORDERING EXAMPLE

**M2013SS1W01**

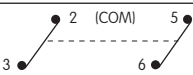
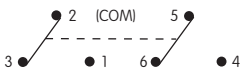

- A Toggles
- Rockers
- Pushbuttons
- Illuminated PB
- Programmable
- Key locks
- Rotaries
- Slides
- Tactiles
- Tilt
- Touch
- Indicators
- Accessories
- Supplement

## POLES & CIRCUITS

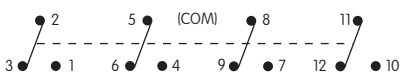
Pole	Model	Toggle Position ( ) = Momentary			Connected Terminals			Throw & Schematics
		Down 	Center 	Up 	Down 	Center 	Up 	
SP	M2011	ON	NONE	OFF	2-3	OPEN	OPEN	SPST 
SP	M2012 M2013 M2015 M2018 M2019	ON ON ON (ON) ON	NONE OFF NONE OFF OFF	ON ON (ON) (ON) (ON)	2-3	OPEN	2-1	SPDT 
DP	M2021	ON	NONE	OFF	2-3 5-6	OPEN	OPEN	DPST 
DP	M2022 M2023 M2025 M2028 M2029	ON ON ON (ON) ON	NONE OFF NONE OFF OFF	ON ON (ON) (ON) (ON)	2-3 5-6	OPEN	2-1 5-4	DPDT 
3P	M2032 M2033 M2035 M2038 M2039	ON ON ON (ON) ON	NONE OFF NONE OFF OFF	ON ON (ON) (ON) (ON)	2-3 5-6 8-9	OPEN	2-1 5-4 8-7	3PDT 
4P	M2042 M2043 M2045 M2048 M2049	ON ON ON (ON) ON	NONE OFF NONE OFF OFF	ON ON (ON) (ON) (ON)	2-3 5-6 8-9 11-12	OPEN	2-1 5-4 8-7 11-10	4PDT 

### For 3 Throw (3-On)

### Connected Terminals & Schematic

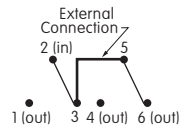
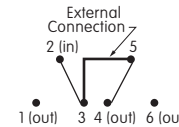
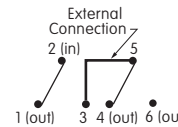
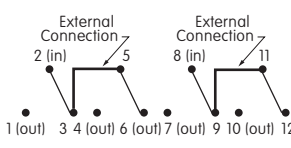
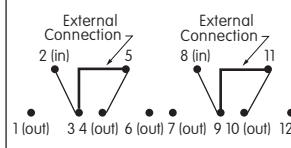
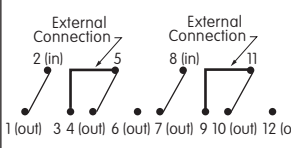
Pole	Model	Down	Center	Up	Down	Center	Up
SP	M2024 M2026 M2027	ON (ON) ON	ON ON ON	ON (ON) (ON)	 2-3 5-6	 2-3 5-4	 2-1 5-4
DP	M2044 M2046 M2047	ON (ON) ON	ON ON ON	ON (ON) (ON)	 2-3 5-6 8-9 11-12	 2-3 5-4 8-9 11-10	 2-1 5-4 8-7 11-10

The SP3T model utilizes a double pole base.

External connection must be made during field installation.

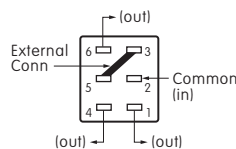

The DP3T model utilizes a four pole base.

External connection must be made during field installation.

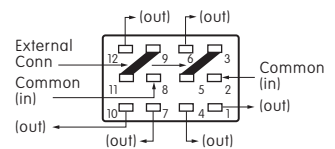

## SMALL TOGGLES

**S** .413" (10.5mm)  
Bat

**S2** .200" (5.08mm)  
Bat

**S3** .256" (6.5mm)  
Bat

### Important:

Toggle length changes based on bushing selected. All illustrations are shown with .350" long bushing. When using a .280" long bushing, toggle length increases .070".

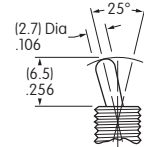
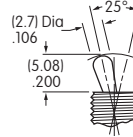
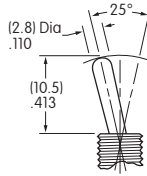

Standard Material & Finish: Brass with Bright Chrome  
Contact factory for optional finishes.

**E** .450" (11.4mm)  
Flatted

**E2** .256" (6.5mm)  
Flatted

**E4** .840" (21.3mm)  
Flatted

**C** .571" (14.5mm)  
Color Tipped Cone  
Supplied with Cap AT445

Colors: A B C  
Material: Polycarbonate

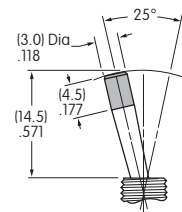
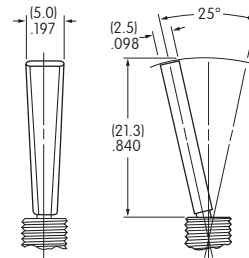
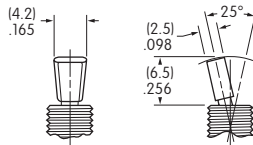
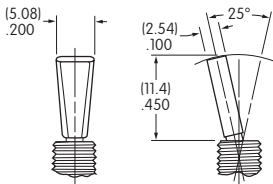

Only Available in 1- & 2-Pole

Only Available in 1- & 2-Pole

**Q** .550" (14.0mm)  
Cone

**Q2** .640" (16.26mm)  
Cone

**Q4** .840" (21.3mm)  
Cone

**D** .840" (21.3mm)  
Color Capped Cone  
Supplied with Cap AT460

Colors: A B C E F G  
Material: Polyethylene

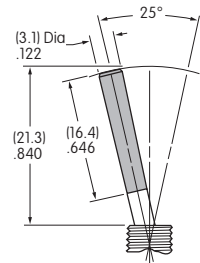
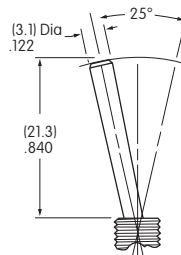
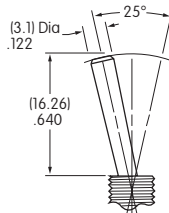
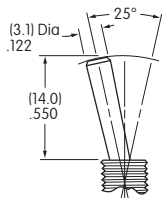

Only Available in 1- & 2-Pole

Only Available in 1- & 2-Pole

Only Available in 1- & 2-Pole

Cap Colors Available:

**A** Black

**B** White

**C** Red

**E** Yellow

**F** Green

**G** Blue

Toggles  
 Rockers  
 Pushbuttons  
 Illuminated PB  
 Programmable  
 Keylocks  
 Rotaries  
 Slides  
 Tactiles  
 Tilt  
 Touch  
 Indicators  
 Accessories  
 Supplement

## SMALL BUSHINGS

**S1** 1/4-40 .350" (8.9mm)  
Threaded with Keyway

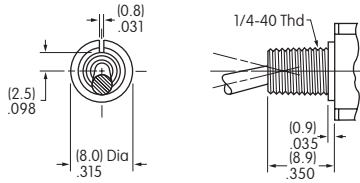

Maximum Panel Thickness with Standard Hardware: .102" (2.6mm)

**S4** 6mm/.350" (8.9mm)  
Threaded with Keyway

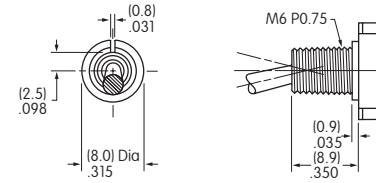

Maximum Panel Thickness with Standard Hardware: .102" (2.6mm)

**S2** .350" (8.9mm)  
Smooth with Keyway

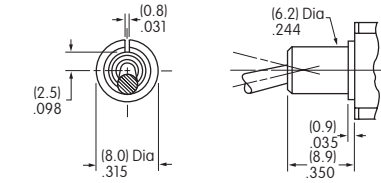

**A1** 1/4-40 .280" (7.1mm)  
Threaded with Keyway

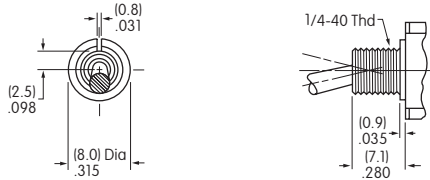

When using this bushing, toggle length is increased by .070". Maximum Panel Thickness with Standard Hardware: .031" (0.8mm)

**A2** .280" (7.1mm)  
Smooth with Keyway

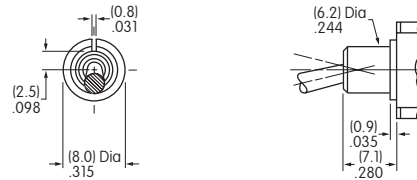

When using this bushing, toggle length is increased by .070".

**D1** 1/4-40 .350" (8.9mm)  
Threaded with D Flat

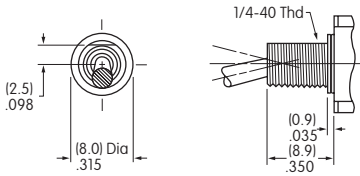

Maximum Panel Thickness with Standard Hardware: .102" (2.6mm)

**D4** 6mm/.350" (8.9mm)  
Threaded with D Flat

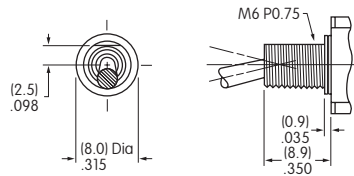

Maximum Panel Thickness with Standard Hardware: .102" (2.6mm)

**D3** 1/4-40 .350" (8.9mm)  
Threaded Splashproof with D Flat

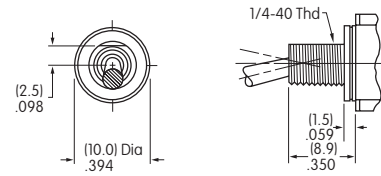

D3 combines only with S, S2 & S3 toggles. Maximum Panel Thickness with Standard Hardware: .193" (4.9mm)

**D8** 6mm/.350" (8.9mm)  
Threaded Splashproof with D Flat

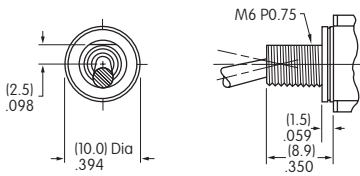

D8 combines only with S, S2 & S3 toggles. Maximum Panel Thickness with Standard Hardware: .193" (4.9mm)

### Standard Hardware Supplied for Small Bushings

	Bushing Codes	S1/S4	A1	D1/D4	D3/D8	L1/L4	L3/L8
Hardware and Quantity	Hex Nut	2	2	2	1	2	1
	Locking Ring	1	1	0	0	1	0
	Lockwasher	1	1	1	0	1	0
	O-ring	0	0	0	1	0	1

For S1, S2, A1, A2 or S4 Bushing with Keyway & for L1 or L4 Bushing

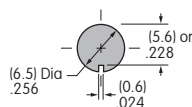

For S1, A1 or S4 Bushing with Locking Ring & for L1 or L4 Bushing

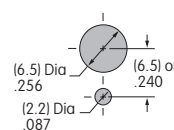

For D1, D4, D3 or D8 Bushing with D Flat & for L3 or L8 Bushing

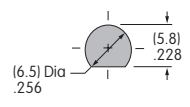

## LARGE TOGGLES

**Toggle & Bushing Combinations:** These toggles combine with the 12mm bushings B1 & B3.

**B** .453" (11.5mm)  
Large Bat

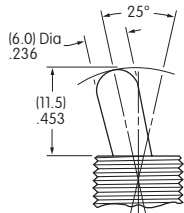

**B2** .689" (17.5mm)  
Large Bat

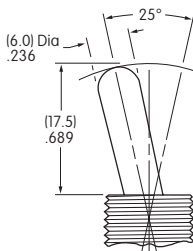

**R** .610" (15.5mm)  
Large Flatted

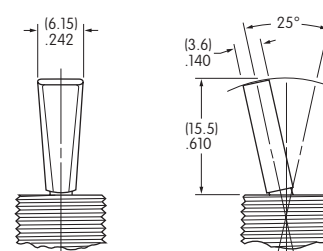

**Standard Material & Finish:** Brass with Bright Chrome  
Optional Finishes: Contact factory for satin chrome or black.

## LARGE BUSHINGS

**B1** Large .472" (12.0mm)  
Threaded with Keyway

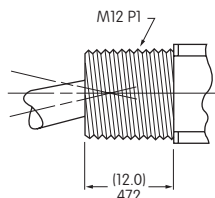
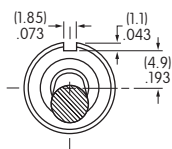

Maximum Panel Thickness with  
Standard Hardware: .216" (5.5mm)

**Standard Hardware for B1:**  
1 hex face nut AT503M, 1 locking ring AT506M,  
1 lockwasher AT508, and 1 hex backup nut AT527M

**B3** Large .472" (12.0mm)  
Threaded Splashproof with D Flat

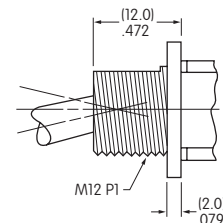
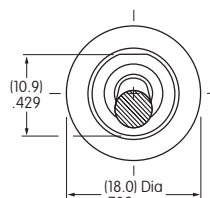

Maximum Panel Thickness with  
Standard Hardware: .256" (6.5mm)

**Standard Hardware for B3:**  
1 hex face nut AT503M  
and 1 o-ring AT401P

### Panel Cutouts

**For B1 Bushing  
with Keyway**

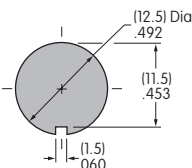

**For B1 Bushing  
with Locking Ring**

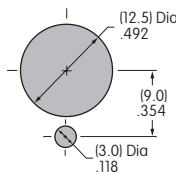

**For B3 Bushing  
with D Flat**

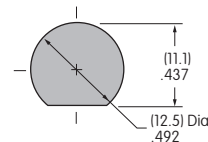

## LOCKING LEVER & BUSHINGS

**LL1** 1/4-40 .291" (7.4mm)  
Threaded with Keyway

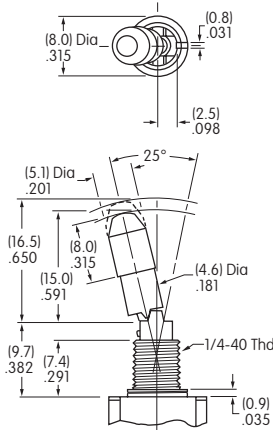

**LL4** 6mm/.291" (7.4mm)  
Threaded with Keyway

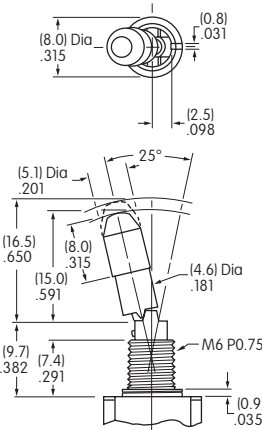

**LL2** Smooth with Keyway

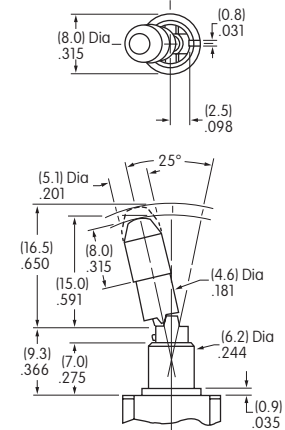

Maximum Panel Thickness with Standard Hardware: .047" (1.2mm)  
Standard Hardware for L1 & L4: 2 hex nuts AT513H or AT513M,  
1 locking ring AT507H or AT507M, and 1 lockwasher AT509

**LL3** 1/4-40 .295" (7.5mm)  
Threaded Splashproof with D Flat

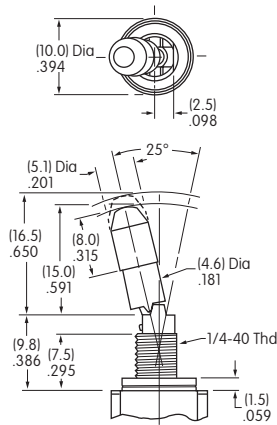

**LL8** 6mm/.295" (7.5mm)  
Threaded Splashproof with D Flat

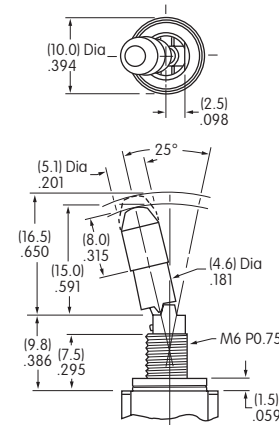

Maximum Panel Thickness with Standard Hardware: .047" (1.2mm)  
Standard Hardware for L3 and L8: 1 hex nut AT513H or AT513M and 1 o-ring AT516

Lever Material & Finish: Brass with Chrome Plating

on-none-on



2 positions lock

on-none-(on)



1 position locks

on-off-(on)  
on-on-(on)



2 positions lock

on-off-on  
on-on-on

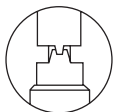

3 positions lock

(on)-off-(on)  
(on)-on-(on)

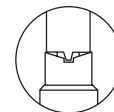

1 position locks

**Locking Mechanism**

**No Code**

Supplied with Cap AT427

Cap Material:  
Brass with Nickel Plating

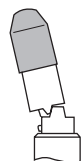

Lever

Color Codes for Optional Anodized Aluminum Caps

**A** Black

**C** Red

**G** Blue



## CONTACT MATERIALS & RATINGS

<b>W</b>	Silver over Silver	Power Level	6A @ 125V AC & 3A @ 250V AC
<b>G</b>	Gold over Brass or Copper	Logic Level	6A @ 125V AC & 3A @ 250V AC
Note: See Supplement section to find complete explanation of operating range.			
<b>A</b>	Gold over Silver	Power Level or Logic Level	6A @ 125V AC or 0.4VA maximum @ 28V AC/DC maximum
Note: This dual rated option is suitable when two or more identical switches are used in logic and in power circuits within the same application. See Supplement section to find complete explanation of dual rating and operating range.			

## TERMINALS

<b>01</b>	Solder Lug		<b>02</b>	.062" (1.57mm) Wide Quick Connect		
<b>03</b>	.250" (6.35mm) Straight PC					
<b>05</b>	.425" (10.8mm) Wirewrap or Extended PC	<b>07</b>	.964" (24.5mm) Wirewrap or Extended PC		Dimension A = terminal lengths as shown beside the terminal codes at the left.	
<b>06</b>	.750" (19.05mm) Wirewrap or Extended PC	<b>08</b>	1.062" (27.0mm) Wirewrap or Extended PC			
If using as extended PC terminal, refer to the above footprints.						

## OPTIONAL CAPS & CAP COLORS

<b>B</b>	* AT415 Lever Cap for S Bat Toggle	<b>C</b>	* AT444 Conical Cap for S Bat Toggle	<b>R</b>	AT434 Lever Cap for B Toggle	<b>V</b>	AT406 Lever Cap for B2 Toggle
Material: Polyethylene		Material: Polyethylene		Material: Polyvinyl Chloride		Material: Polyvinyl Chloride	
* AT415 and AT444 for use with S toggles only, not S2 or S3 toggles.							

Cap Colors Available: **A** Black **B** White **C** Red **E** Yellow **F** Green **G** Blue

## TYPICAL SWITCH DIMENSIONS

### Solder Lug

### Single Pole

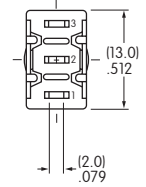
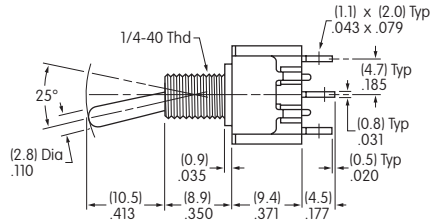
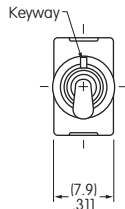

M2012SS1W01

M2011 model does not have terminal 1.

### Solder Lug

### Double Pole

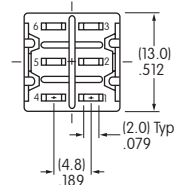
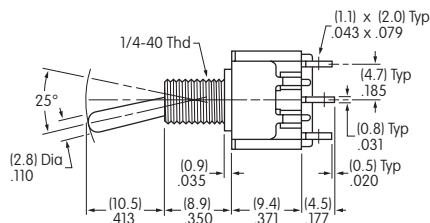
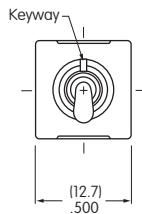

M2022SS1W01

M2021 model does not have terminals 1 & 4.

### Solder Lug

### Three Pole

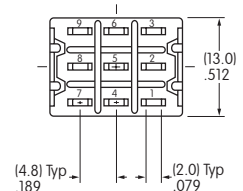
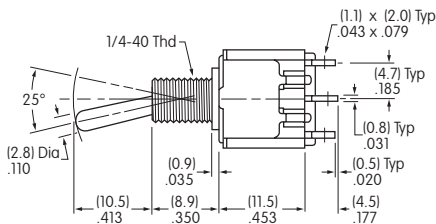
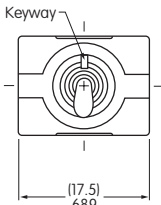

M2032SS1W01

### Solder Lug

### Four Pole

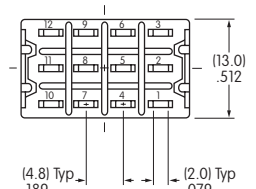
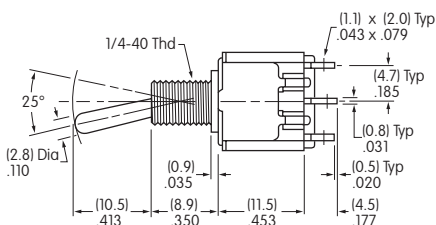
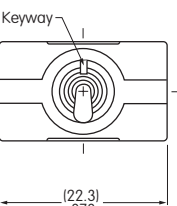

M2042SS1W01

Rockers

Pushbuttons

Illuminated PB

Programmable

Keylocks

Rotaries

Slides

Tactiles

Tilt

Touch

Indicators

Accessories

Supplement

## STANDARD HARDWARE FOR SMALL & LARGE BUSHINGS

**AT513H for Inch  
AT513M for Metric  
Hex Nut**  
Brass/Nickel

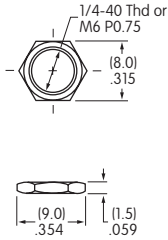

**AT507H for Inch  
AT507M for Metric  
Locking Ring**  
Steel with Zinc/Chromate

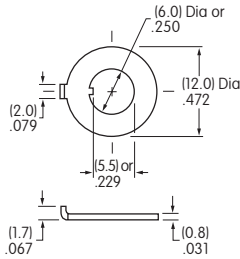

**AT509  
Lockwasher**  
Steel with Zinc/Chromate  
(not supplied with splashproof models)

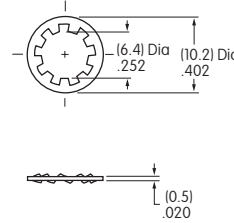

**AT516  
O-ring for  
Splashproof Models**  
Nitrile Butadiene Rubber

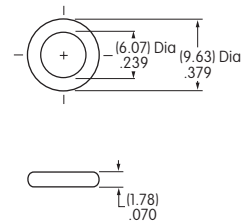

**AT503M  
Hex Face Nut**  
Brass/Chrome

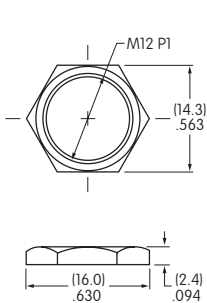

**AT506M  
Locking Ring**  
Steel with Zinc/Chromate

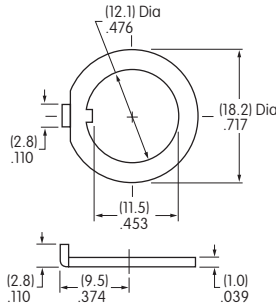

**AT508  
Lockwasher**  
Steel with Zinc/Chromate  
(not supplied with splashproof models)

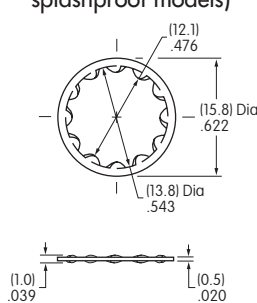

**AT527M  
Hex Nut**  
Steel with  
Nickel Plating

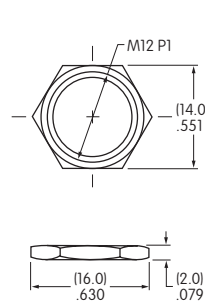

**AT401P  
O-ring for Splashproof  
Models**  
Nitrile butadiene rubber

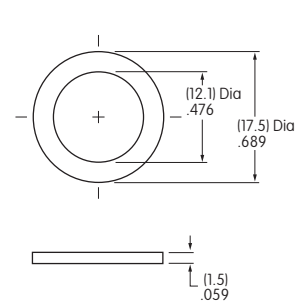

## OPTIONAL SPLASHPROOF BOOTS

Various optional nuts and ON-OFF plates are available; dimensions are shown in the Accessories & Hardware section.

**AT428 (M-metric H-Inch)  
.445" (11.3mm)**  
Boot for S Toggle  
Silicon Rubber

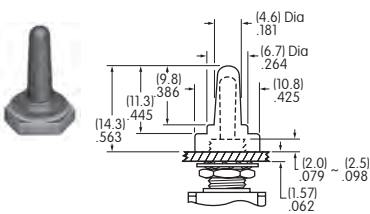

**AT402  
.760" (19.3mm)**  
Boot for B2 Toggle  
Silicon Rubber

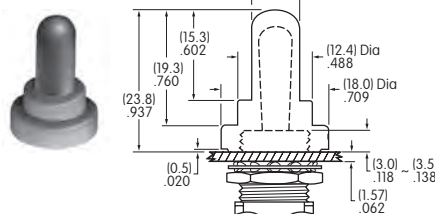

**AT402S  
.567" (14.4mm)**  
Boot for B Toggle  
Silicon Rubber

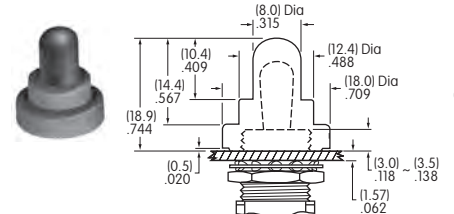

**AT401A/H/S  
.461" (11.7mm)**  
Boot, Nut and O-ring for B2 Toggle  
More details in Accessories section

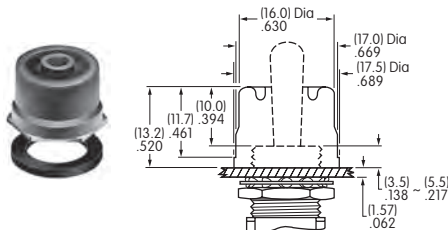

**AT4181  
.732" (18.6mm)**  
Boot, Nut and O-ring for B2 Toggle  
More details in Accessories section

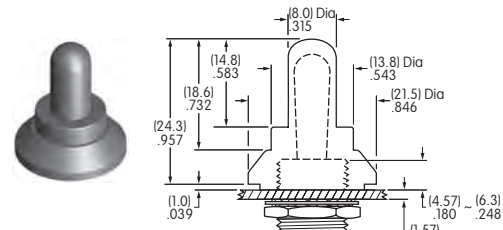

Toggles  
 A  
 Rockers  
 Pushbuttons  
 Illuminated PB  
 Programmable  
 Keylocks  
 Rotaries  
 Slides  
 Tactiles  
 Tilt  
 Touch  
 Indicators  
 Accessories  
 Supplement

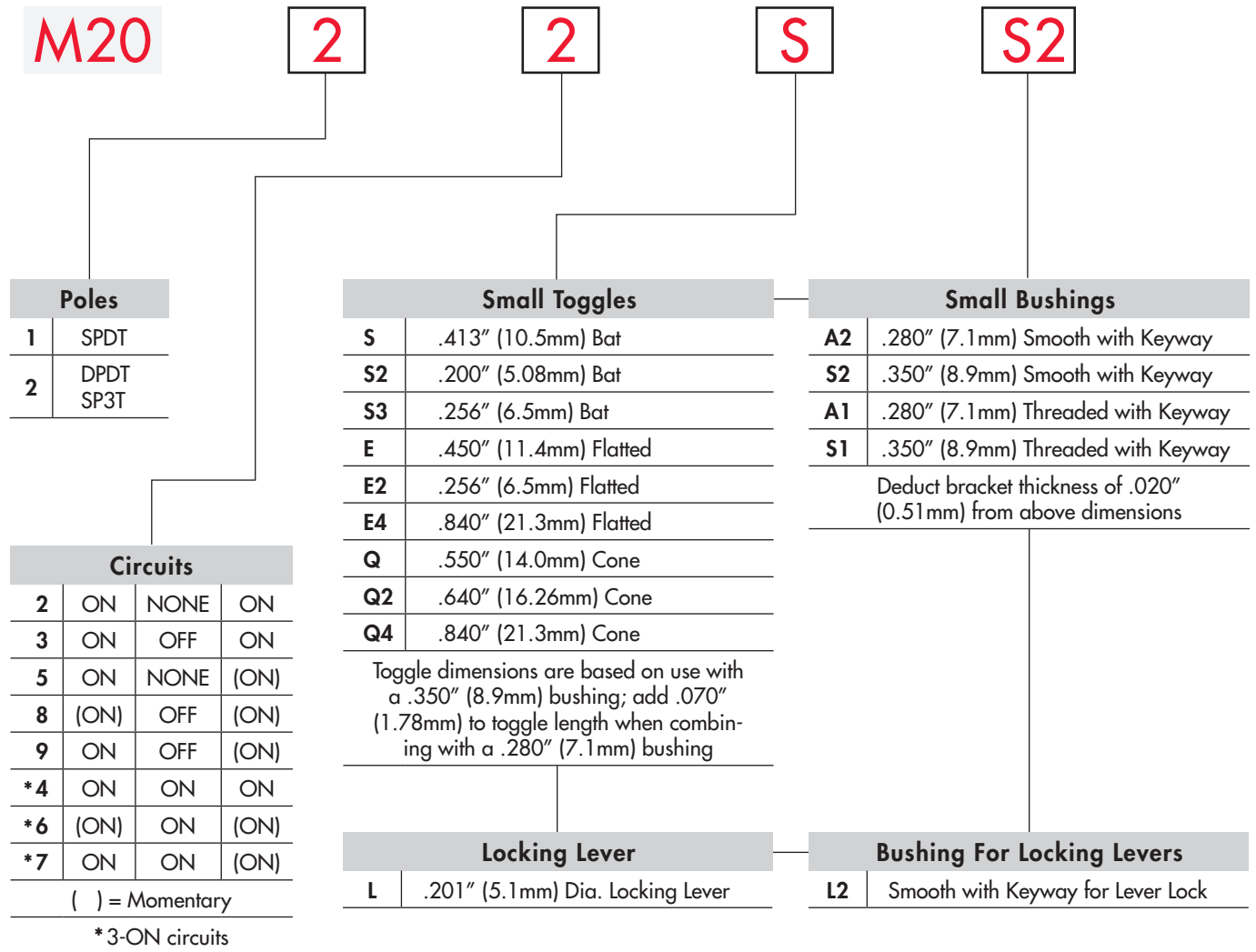

**Standard Toggle & Bushing Combinations:**  
**SS2 & S2A2**

**IMPORTANT:**



Switches are supplied without UL, cULus & CSA marking unless specified.  
**UL, cULus & CSA recognized only when ordered with marking on the switch.**  
 Specific models, ratings & ordering instructions are noted on the General Specifications page.

## ORDERING EXAMPLE

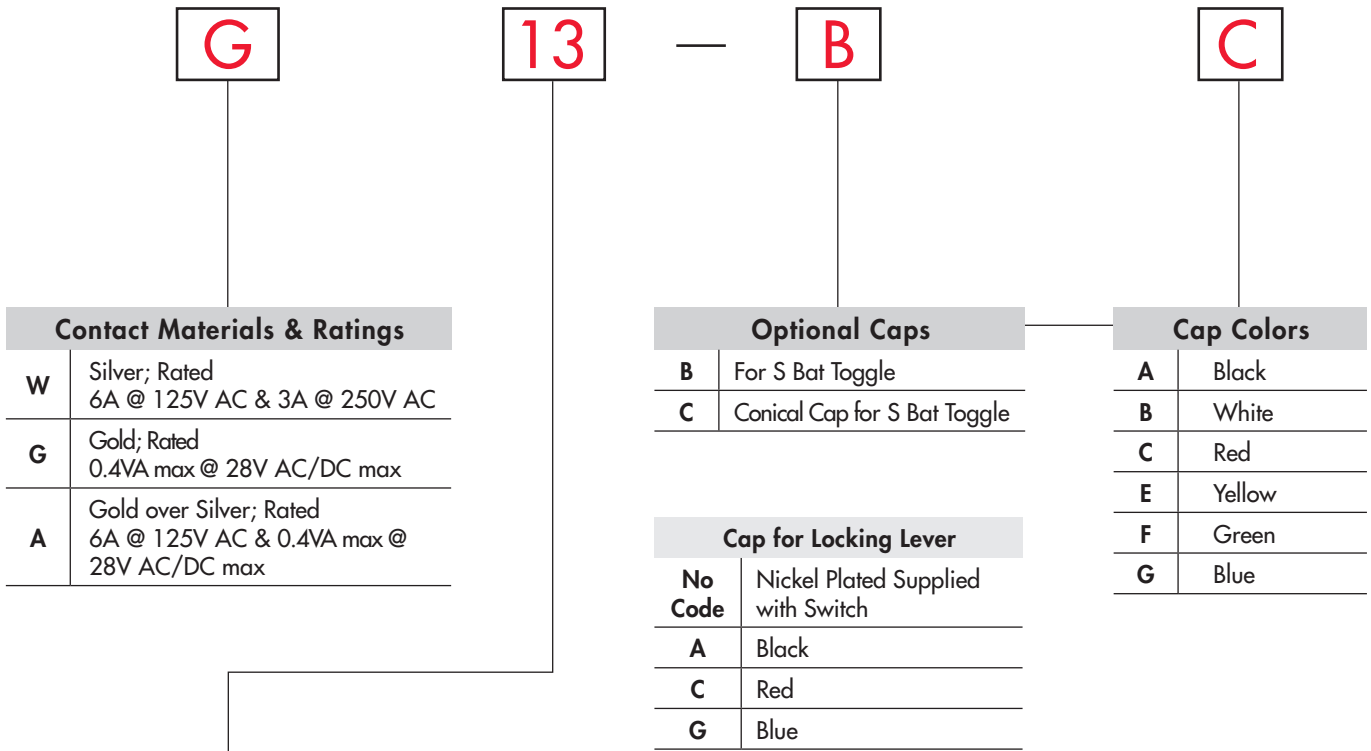

Contact Materials & Ratings	
<b>W</b>	Silver; Rated 6A @ 125V AC & 3A @ 250V AC
<b>G</b>	Gold; Rated 0.4VA max @ 28V AC/DC max
<b>A</b>	Gold over Silver; Rated 6A @ 125V AC & 0.4VA max @ 28V AC/DC max

Terminals	
With Bracket	
<b>13</b>	.250" (6.35mm) Straight PC with .465" (11.8mm) Bracket
<b>15</b>	.425" (10.8mm) Straight PC with .630" (16.0mm) Bracket
<b>17</b>	.964" (24.5mm) Straight PC with 1.150" (29.2mm) Bracket
With Reinforced Bracket	
<b>23</b>	.250" (6.35mm) Straight PC with .465" (11.8mm) Bracket
<b>25</b>	.425" (10.8mm) Straight PC with .630" (16.0mm) Bracket
<b>26</b>	.750" (19.05mm) Straight PC with .953" (24.2mm) Bracket

Optional Caps	
<b>B</b>	For S Bat Toggle
<b>C</b>	Conical Cap for S Bat Toggle

Cap for Locking Lever	
<b>No Code</b>	Nickel Plated Supplied with Switch
<b>A</b>	Black
<b>C</b>	Red
<b>G</b>	Blue





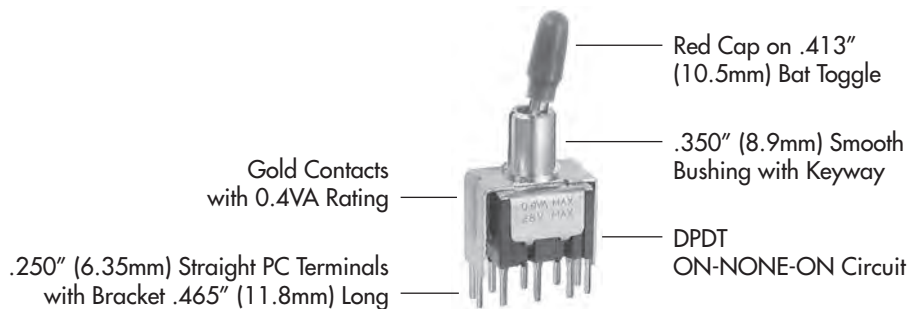

Cap Colors	
<b>A</b>	Black
<b>B</b>	White
<b>C</b>	Red
<b>E</b>	Yellow
<b>F</b>	Green
<b>G</b>	Blue

### DESCRIPTION FOR TYPICAL ORDERING EXAMPLE

**M2022SS2G13-BC**

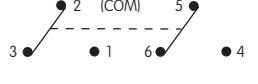

## POLES & CIRCUITS

Pole	Model	Toggle Position ( ) = Momentary			Connected Terminals			Throw & Schematics
		Down 	Center 	Up 	Down 	Center 	Up 	
SP	M2012 M2013 M2015 M2018 M2019	ON ON ON (ON) ON	NONE OFF NONE OFF OFF	ON ON (ON) (ON) (ON)	2-3	OPEN	2-1	SPDT 
DP	M2022 M2023 M2025 M2028 M2029	ON ON ON (ON) ON	NONE OFF NONE OFF OFF	ON ON (ON) (ON) (ON)	2-3 5-6	OPEN	2-1 5-4	DPDT 

### For 3 Throw (3-On)

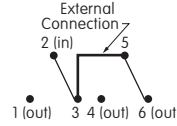
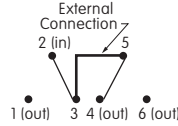
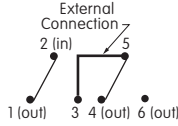
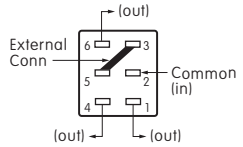
Pole	Model	Connected Terminals & Schematics			External Connection
		Down	Center	Up	
SP	M2024 M2026 M2027	ON (ON) ON  	ON ON ON  	ON (ON) (ON)  	The SP3T model utilizes a double pole base.  External connection must be made during field installation. 

## SMALL TOGGLES

### Important:

Toggle length changes based on bushing selected. All illustrations are shown with .350" (8.9mm) long bushing. When using a .280" (7.1mm) long bushing, toggle length increases .070" (1.78mm).

### Standard Material & Finish:

Brass with Bright Chrome  
Contact factory for optional finishes.

**S** .413" (10.5mm) Bat

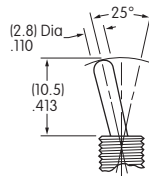

**S2** .200" (5.08mm) Bat

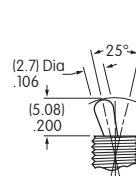

**S3** .256" (6.5mm) Bat

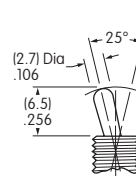

**E** .450" (11.4mm) Flatted

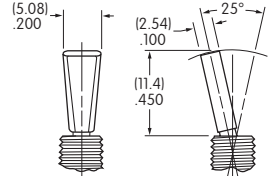

**E2** .256" (6.5mm) Flatted

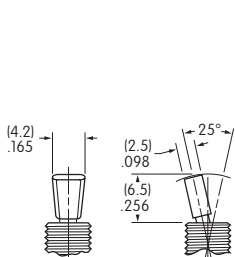

**E4** .840" (21.3mm) Flatted

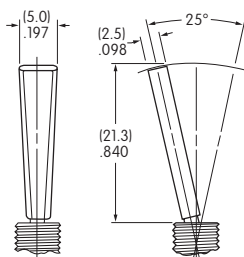

**Q** .550" (14.0mm) Cone

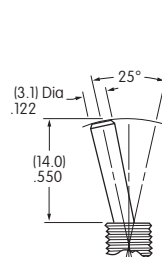

**Q2** .640" (16.26mm) Cone

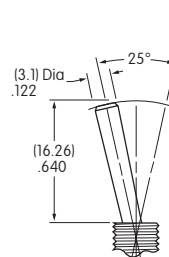

**Q4** .840" (21.3mm) Cone

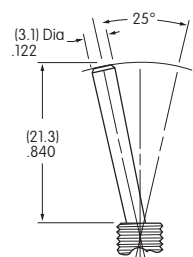

## SMALL BUSHINGS

A Toggles

Rockers

Pushbuttons

Illuminated PB

Programmable

Key locks

Rotaries

Slides

Tactiles

Tilt

Touch

Indicators

Accessories

Supplement

**A2** .280" (7.1mm)  
Smooth with Keyway

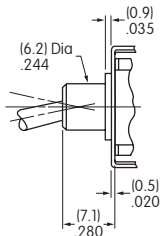
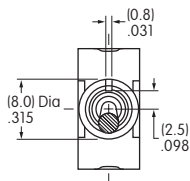

**S2** .350" (8.9mm)  
Smooth with Keyway

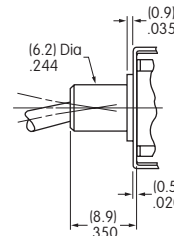
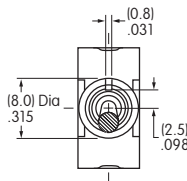

When using this bushing, toggle length is increased by .070" (1.78mm).

**A1** .280" (7.1mm)  
Threaded with Keyway

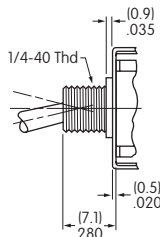
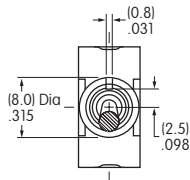

**S1** .350" (8.9mm)  
Threaded with Keyway

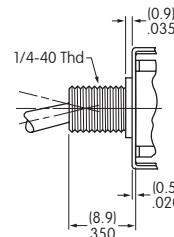
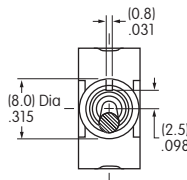

When using this bushing, toggle length is increased by .070" (1.78mm). Maximum Panel Thickness with Standard Hardware: .031" (0.8mm)

Maximum Panel Thickness with Standard Hardware: .102" (2.6mm)

### Panel Cutouts

For A2, S2, A1, or S1 Bushing with Keyway

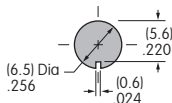

For A1 or S1 Bushing with Locking Ring

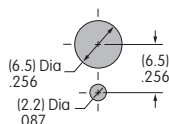

### Standard Hardware:

- 2 Hex Nuts (AT513H)
- 1 Lockwasher (AT509)
- 1 Locking Ring (AT507H)

For dimensions, see Accessories & Hardware section.

## LOCKING LEVER & BUSHING

**LL2** Smooth with Keyway

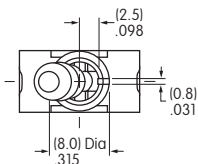

### Locking Mechanism

on-none-on



2 positions lock

on-none-(on)



1 position locks

on-off-(on)  
on-on-(on)



2 positions lock

on-off-on  
on-on-on

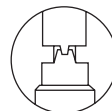

3 positions lock

(on)-off-(on)  
(on)-on-(on)

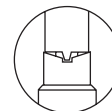

1 position locks

**No Code**

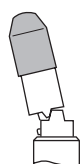

Cap for Locking Lever  
Supplied with Cap AT427  
Material & Finish:

Brass with Nickel Plating

Lever Material & Finish:

Brass with Chrome Plating

Color Codes for Optional Anodized Aluminum Caps

**A** Black

**C** Red

**G** Blue

### CONTACT MATERIALS & RATINGS

**W** Silver over Silver      Power Level      6A @ 125V AC & 3A @ 250V AC

**G** Gold over Brass or Copper      Logic Level      0.4VA maximum @ 28V AC/DC maximum

Note: See Supplement section to find complete explanation of operating range.

**A** Gold over Silver      Power Level or Logic Level      6A @ 125V AC or 0.4VA maximum @ 28V AC/DC maximum

Note: This dual rated option is suitable when two or more identical switches are used in logic and in power circuits within the same application. See Supplement section to find complete explanation of dual rating and operating range.

### TERMINALS

#### Straight PC Mount with Bracket

#### Straight PC Mount with Reinforced Bracket

13	15	17	23	25	26
.250" (6.35mm) Terminal with .465" (11.8mm) Bracket	.425" (10.8mm) Terminal with .630" (16.0mm) Bracket	.964" (24.5mm) Terminal with 1.150" (29.2mm) Bracket	.250" (6.35mm) Terminal with .465" (11.8mm) Bracket	.425" (10.8mm) Terminal with .630" (16.0mm) Bracket	.750" (19.05mm) Terminal with .953" (24.2mm) Bracket

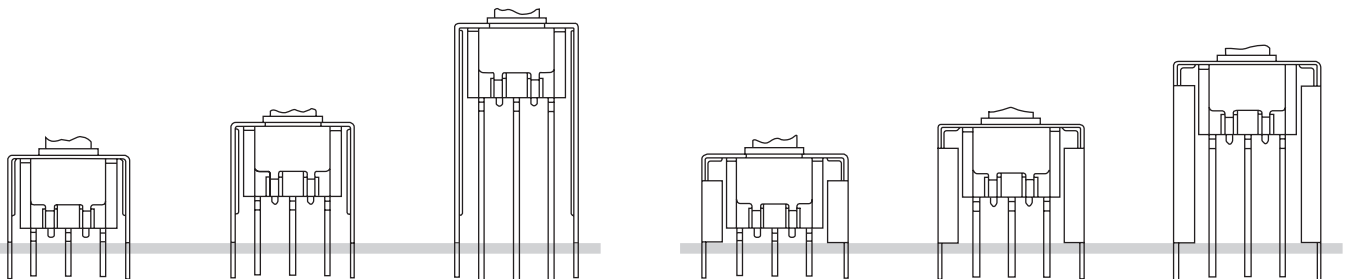

PCB footprints are on the following Typical Switch Dimension page.

### OPTIONAL CAPS & CAP COLORS

**B** \* AT415  
for S Bat Toggle

Material:  
Polyethylene

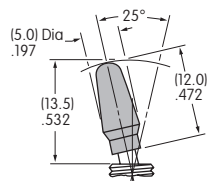

**C** \* AT444  
Conical Cap for  
S Bat Toggle

Material:  
Polyethylene

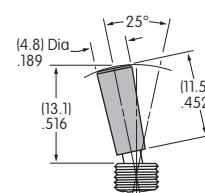

\* AT415 and AT444 for use with S toggles only, not S2 or S3 toggles.

Cap Colors  
Available:

**A** Black    **B** White    **C** Red    **E** Yellow    **F** Green    **G** Blue



## TYPICAL SWITCH DIMENSIONS

Straight PC • Bracket

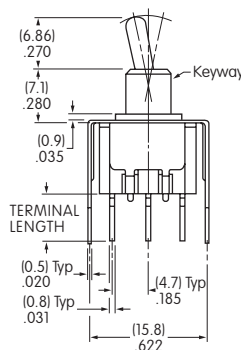
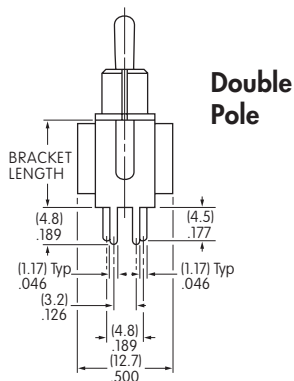
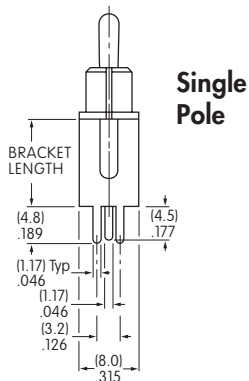

**M2012S2A2G13**

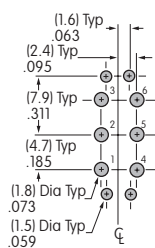
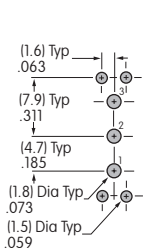

Terminal Code:	Terminal Length:	Bracket Length:
<b>13</b>	.250" (6.35mm)	.465" (11.8mm)
<b>15</b>	.425" (10.8mm)	.630" (16.0mm)
<b>17</b>	.964" (24.5mm)	1.150" (29.2mm)

Straight PC • Reinforced Bracket

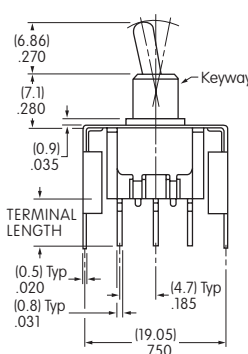
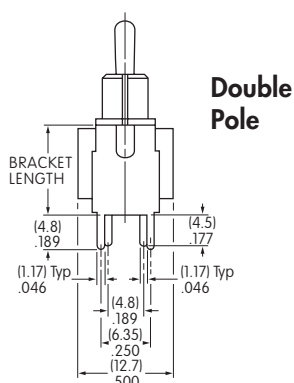
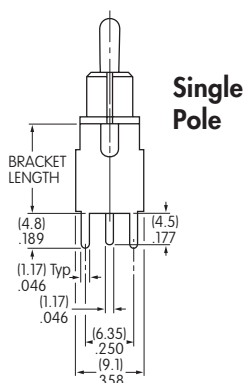

**M2012S2A2G23**

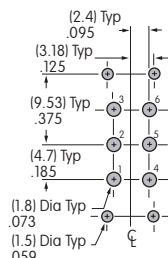
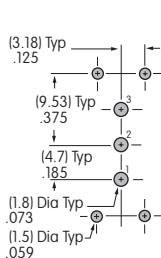

Terminal Code:	Terminal Length:	Bracket Length:
<b>23</b>	.250" (6.35mm)	.465" (11.8mm)
<b>25</b>	.425" (10.8mm)	.630" (16.0mm)
<b>26</b>	.750" (19.05mm)	.953" (24.2mm)

Toggles  
 Rockers  
 Pushbuttons  
 Illuminated PB  
 Programmable  
 Keylocks  
 Rotaries  
 Slides  
 Tactiles  
 Tilt  
 Touch  
 Indicators  
 Accessories  
 Supplement

**M20**

**1**

**2**

**S2**

**A2**

Poles	
1	SPDT
2	DPDT SP3T
3	3PDT
*4	4PDT DP3T

\*4-pole available on vertical models only.

Small Toggles	
S	.413" (10.5mm) Bat
S2	.200" (5.08mm) Bat
S3	.256" (6.5mm) Bat
E	.450" (11.4mm) Flatted
E2	.256" (6.5mm) Flatted

Toggle dimensions are based on use with a .350" (8.9mm) bushing; add .070" (1.78mm) to toggle length when combining with a .280" (7.1mm) bushing.

Small Bushings	
A2	.280" (7.1mm) Smooth with Keyway
S2	.350" (8.9mm) Smooth with Keyway
A1	.280" (7.1mm) Threaded with Keyway
S1	.350" (8.9mm) Threaded with Keyway

Circuits			
2	ON	NONE	ON
3	ON	OFF	ON
5	ON	NONE	(ON)
8	(ON)	OFF	(ON)
9	ON	OFF	(ON)
*4	ON	ON	ON
*6	(ON)	ON	(ON)
*7	ON	ON	(ON)

Locking Lever	
L	.201" (5.1mm) Dia. Locking Lever

Bushing For Locking Levers	
L2	Smooth with Keyway for Lever Lock

( ) = Momentary

\*3-ON circuits available with double and four pole bases only

**Standard Toggle, Bushing, & Terminal Combinations:**  
**S2A2G30, S2A2G40, SS2G30, SS2G40, LL2G30, & LL2G40**

**IMPORTANT:**



Switches are supplied without UL, cULus & CSA marking unless specified.  
**UL, cULus & CSA recognized only when ordered with marking on the switch.**  
 Specific models, ratings & ordering instructions are noted on the General Specifications page.

## ORDERING EXAMPLE

G

40

Contact Materials & Ratings	
<b>W</b>	Silver; Rated 6A @ 125V AC & 3A @ 250V AC
<b>G</b>	Gold; Rated 0.4VA max @ 28V AC/DC max
<b>A</b>	Gold over Silver; Rated 6A @ 125V AC & 0.4VA max @ 28V AC/DC max

Optional Caps	
<b>B</b>	For S Bat Toggle
<b>C</b>	Conical Cap for S Bat Toggle

Cap Colors	
<b>A</b>	Black
<b>B</b>	White
<b>C</b>	Red
<b>E</b>	Yellow
<b>F</b>	Green
<b>G</b>	Blue

Cap for Locking Lever	
<b>No Code</b>	Nickel Plated Supplied with Switch
<b>A</b>	Black
<b>C</b>	Red
<b>G</b>	Blue





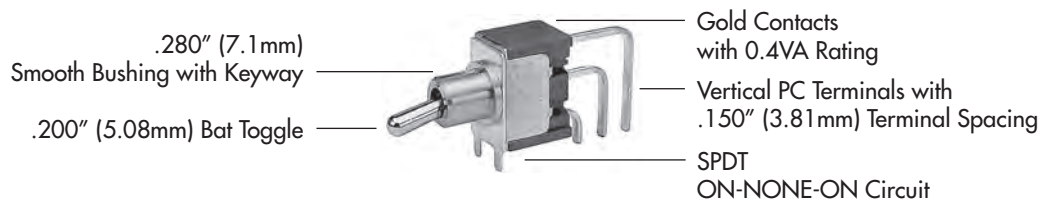

Terminals	
<b>30</b>	.150" (3.81mm) Right Angle PC (1-3 Pole)
<b>32</b>	Right Angle PCB (1 Pole & 0.4VA Rating Only)
<b>40</b>	.150" (3.81mm) Vertical PC (1-4 Pole)
<b>45</b>	.100" (2.54mm) Vertical PC (1-4 Pole)

### DESCRIPTION FOR TYPICAL ORDERING EXAMPLE

M2012S2A2G40

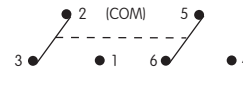
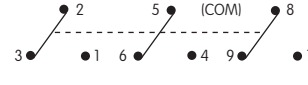
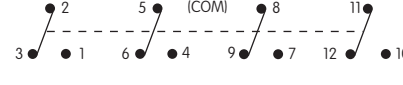

## POLES & CIRCUITS

Pole	Model	Toggle Position ( ) = Momentary			Connected Terminals			Throw & Schematics
		Down 	Center 	Up 	Down 	Center 	Up 	
SP	* M2012 * M2013 M2015 * M2018 M2019	ON ON ON (ON) ON	NONE OFF NONE OFF OFF	ON ON (ON) (ON) (ON)	2-3	OPEN	2-1	SPDT 
DP	* M2022 * M2023 M2025 * M2028 M2029	ON ON ON (ON) ON	NONE OFF NONE OFF OFF	ON ON (ON) (ON) (ON)	2-3 5-6	OPEN	2-1 5-4	DPDT 
3P	M2032 M2033 M2035 M2038 M2039	ON ON ON (ON) ON	NONE OFF NONE OFF OFF	ON ON (ON) (ON) (ON)	2-3 5-6 8-9	OPEN	2-1 5-4 8-7	3PDT 
4P	M2042 M2043 M2045 M2048 M2049	ON ON ON (ON) ON	NONE OFF NONE OFF OFF	ON ON (ON) (ON) (ON)	2-3 5-6 8-9 11-12	OPEN	2-1 5-4 8-7 11-10	4PDT 

### For 3 Throw (3-On)

### Connected Terminals & Schematics

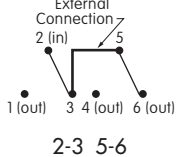
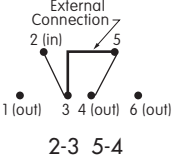
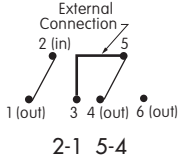
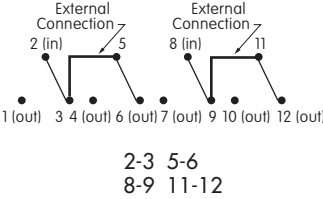
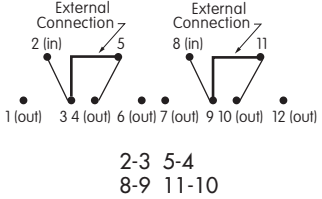
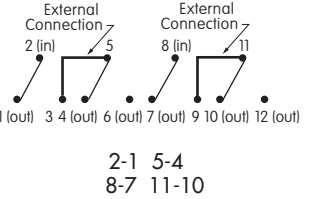
Pole	Model	Down	Center	Up	Down	Center	Up
SP	M2024 M2026 M2027	ON (ON) ON	ON ON ON	ON (ON) (ON)			
DP	M2044 M2046 M2047	ON (ON) ON	ON ON ON	ON (ON) (ON)			

The SP3T model utilizes a double pole base.

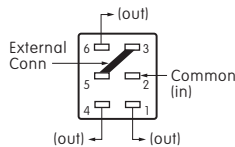

External connection must be made during field installation.

The DP3T model utilizes a four pole base.

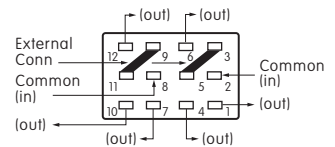

External connection must be made during field installation.

## SMALL TOGGLES

### Important:

Toggle length changes based on bushing selected. All illustrations are shown with .350" (8.9mm) long bushing. When using a .280" (7.1mm) long bushing, toggle length increases .070" (1.78mm).

**S** .413" (10.5mm)  
Bat

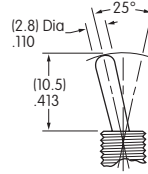

**S2** .200" (5.08mm)  
Bat

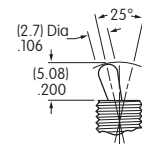

**S3** .256" (6.5mm)  
Bat

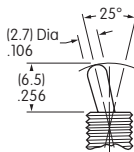

**E** .450" (11.4mm)  
Flatted

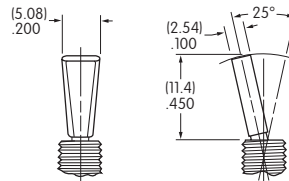

**E2** .256" (6.5mm)  
Flatted

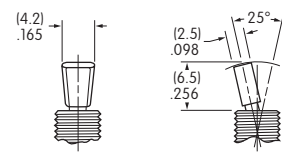

Standard Material & Finish: Brass with Bright Chrome  
Contact factory for optional finishes.

## SMALL BUSHINGS

**A2** .280" (7.1mm)  
Smooth with Keyway

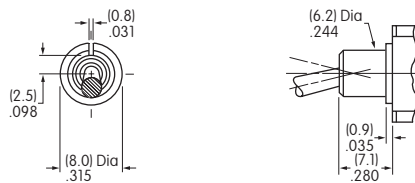

**S2** .350" (8.9mm)  
Smooth with Keyway

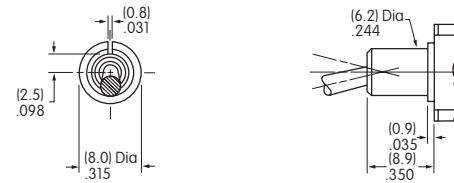

When using this bushing, toggle length is increased by .070" (1.78mm).

**A1** .280" (7.1mm)  
Threaded with Keyway

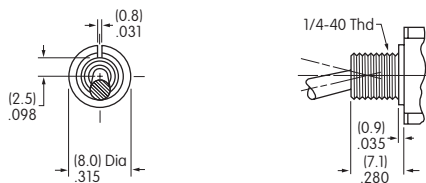

**S1** .350" (8.9mm)  
Threaded with Keyway

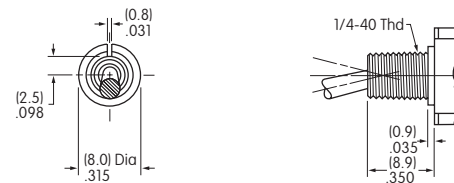

When using this bushing, toggle length is increased by .070" (1.78mm). Maximum Panel Thickness with Standard Hardware: .031" (0.8mm)

Maximum Panel Thickness with Standard Hardware: .102" (2.6mm)

### Panel Cutouts

For A2, S2, A1 or S1 Bushing with Keyway

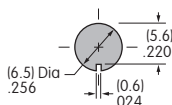

For A1 or S1 Bushing with Locking Ring

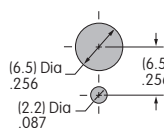

### Standard Hardware:

- 2 Hex Nuts (AT513H)
- 1 Lockwasher (AT509)
- 1 Locking Ring (AT507H)

For dimensions, see Accessories & Hardware section.

### LOCKING LEVER & BUSHING

#### LL2 Smooth with Keyway

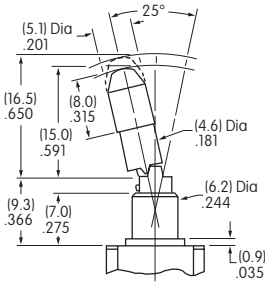
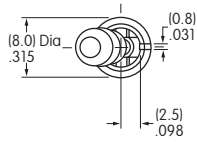

on-none-on

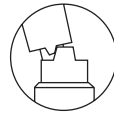

2 positions lock

on-none-(on)



1 position locks

on-off-(on)  
on-on-(on)



2 positions lock

on-off-on  
on-on-on

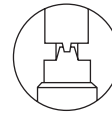

3 positions lock

(on)-off-(on)  
(on)-on-(on)

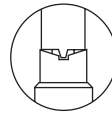

1 position locks

**No Code**

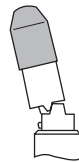

Cap for Locking Lever

Supplied with Cap AT427  
Material & Finish:

Brass with Nickel Plating

Lever Material & Finish:

Brass with Chrome Plating

Color Codes for Optional  
Anodized Aluminum Caps



Black



Red



Blue

### CONTACT MATERIALS & RATINGS

**W**

Silver over Silver

Power Level

6A @ 125V AC & 3A @ 250V AC

**G**

Gold over Brass or Copper

Logic Level

0.4VA maximum @ 28V AC/DC maximum

Note: See Supplement section to find complete explanation of operating range.

**A**

Gold over Silver

Power Level  
or Logic Level

6A @ 125V AC  
or 0.4VA maximum @ 28V AC/DC maximum

Note: This dual rated option is suitable when two or more identical switches are used in logic and in power circuits within the same application. See Supplement section to find complete explanation of dual rating and operating range.

### TERMINALS

#### 30 .150" (3.81mm) Right Angle PC (1-3 Pole)

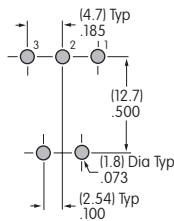
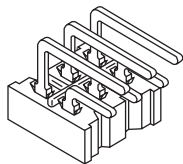

Single Pole

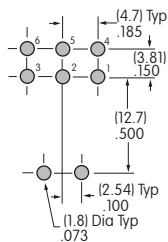

Double Pole

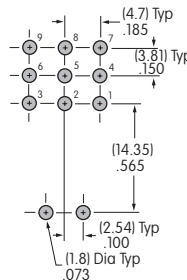

Three Pole

#### 32 Right Angle PCB with Reverse Circuit (1 Pole & 0.4VA Rating Only)

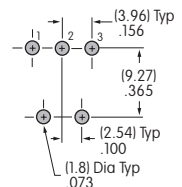
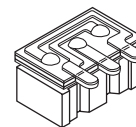

Terminal dimensions are shown on the Typical Switch Dimensions pages which follow.

## TERMINALS (Continued)

A  
Toggles

**40** .150" (3.81 mm)  
Vertical PC (1-4 Pole)

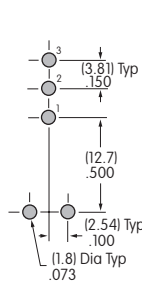
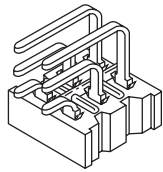

Single Pole

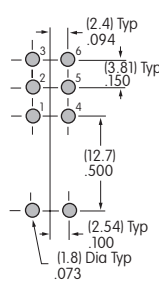

Double Pole

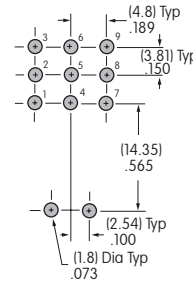

Three Pole

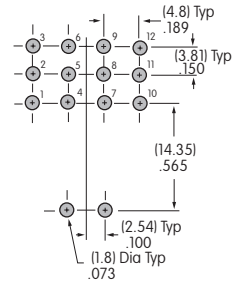

Four Pole

**45** .100" (2.54mm)  
Vertical PC (1-4 Pole)

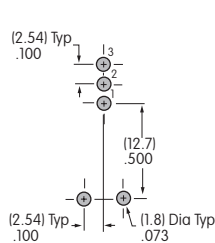
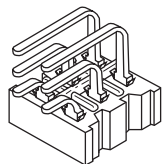

Single Pole

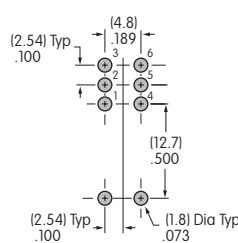

Double Pole

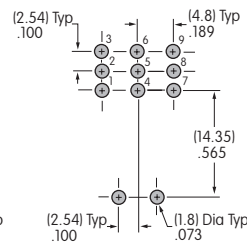

Three Pole

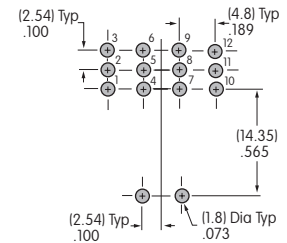

Four Pole

Terminal dimensions are shown on the Typical Switch Dimensions pages which follow.

## OPTIONAL CAPS & CAP COLORS

**B** \* AT415  
for S Bat Toggle

Material:  
Polyethylene

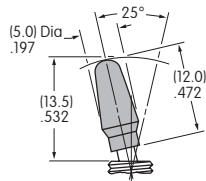

**C** \* AT444  
Conical Cap for S Bat Toggle

Material:  
Polyethylene

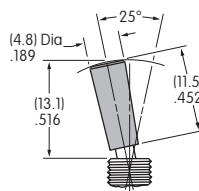

Colors Available

- |                |                 |
|----------------|-----------------|
| <b>A</b> Black | <b>E</b> Yellow |
| <b>B</b> White | <b>F</b> Green  |
| <b>C</b> Red   | <b>G</b> Blue   |

\* AT415 and AT444 for use with S toggles only, not S2 or S3 toggles.

## STANDARD HARDWARE

AT513H for Inch  
AT513M for Metric  
Hex Nut (2 per switch)  
Brass/Nickel

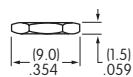
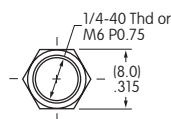

AT507H for Inch  
AT507M for Metric  
Locking Ring (1 per switch)  
Steel with Zinc/Chromate

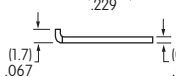
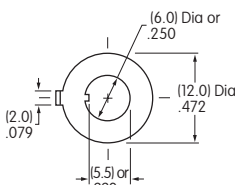

AT509  
Lockwasher (1 per switch, none  
with splashproof)  
Steel with Zinc/Chromate

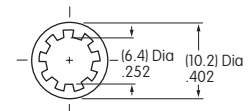

Rockers

Pushbuttons

Illuminated PB

Programmable

Keylocks

Rotaries

Slides

Tactiles

Tilt

Touch

Indicators

Accessories

Supplement

## TYPICAL SWITCH DIMENSIONS

### .150" (3.81mm) Right Angle PC

### Single Pole

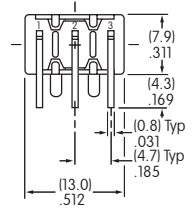
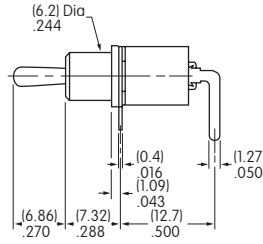
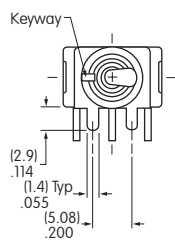

**M2012S2A2G30**

### .150" (3.81mm) Right Angle PC

### Double Pole

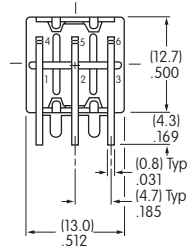
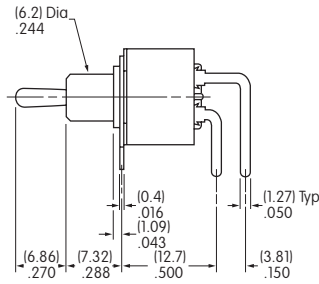
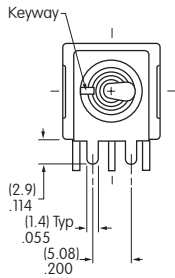

**M2022S2A2G30**

### .150" (3.81mm) Right Angle PC

### Three Pole

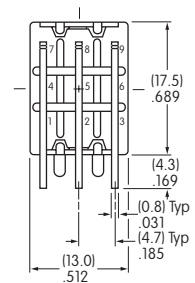
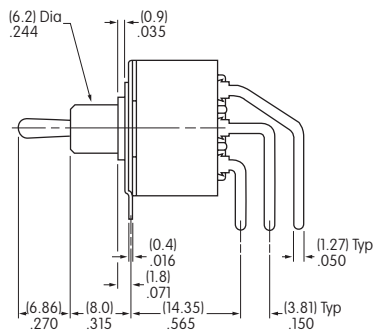
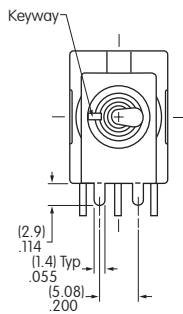

**M2032S2A2G30**



## TYPICAL SWITCH DIMENSIONS

### Single Pole • Reverse Circuit

### Right Angle PCB

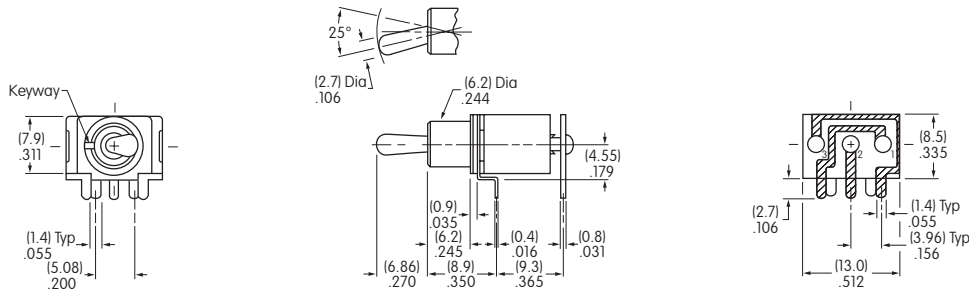

**M2012S2A2G32**

### Single Pole

### .150" (3.81mm) Vertical PC

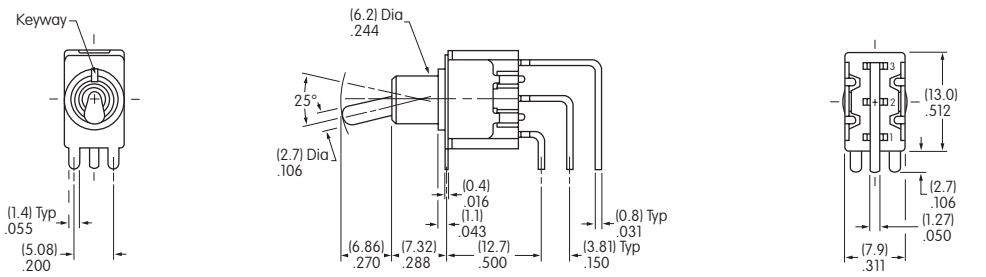

**M2012S2A2G40**

### Double Pole

### .150" (3.81mm) Vertical PC

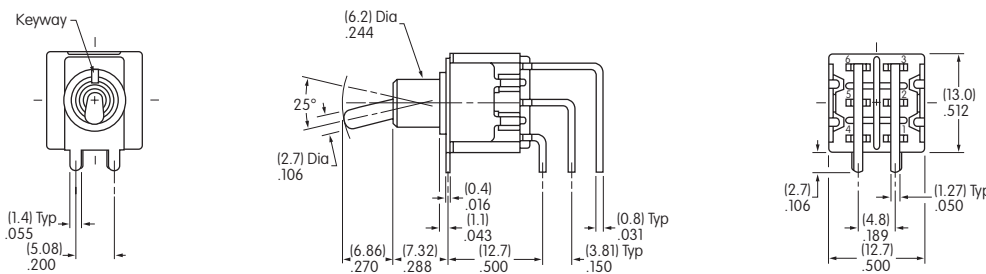

**M2022S2A2G40**

## TYPICAL SWITCH DIMENSIONS

### .150" (3.81mm) Vertical PC

### Three Pole

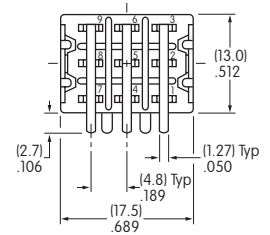
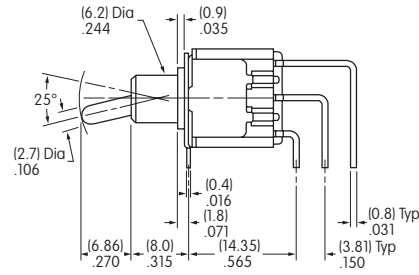
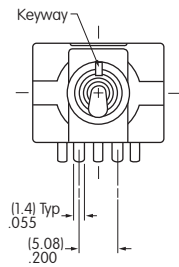

**M2032S2A2G40**

### .150" (3.81mm) Vertical PC

### Four Pole

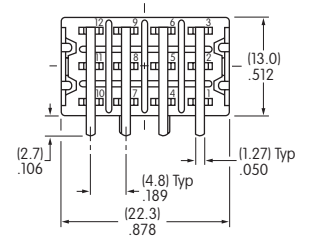
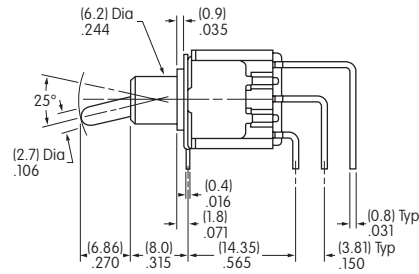
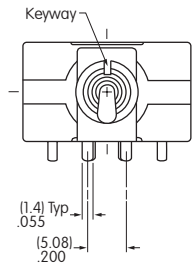
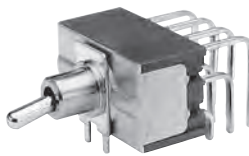

**M2042S2A2G40**

### .100" (2.54mm) Vertical PC

### Single Pole

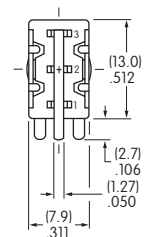
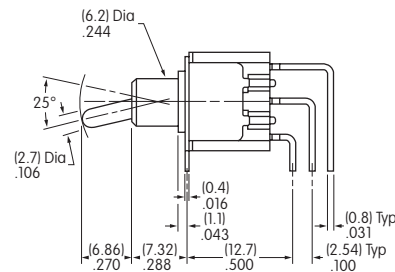
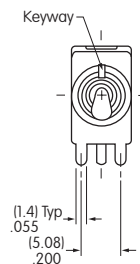

**M2012S2A2G45**

TYPICAL SWITCH DIMENSIONS

Double Pole

.100" (2.54mm) Vertical PC

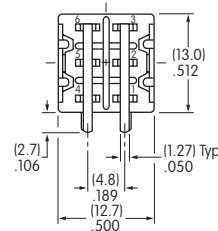
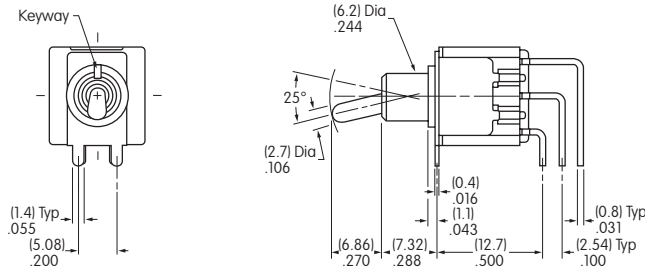

M2022S2A2G45

Three Pole

.100" (2.54mm) Vertical PC

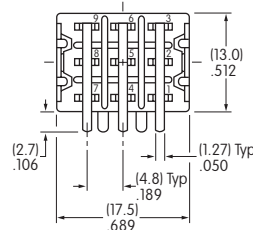
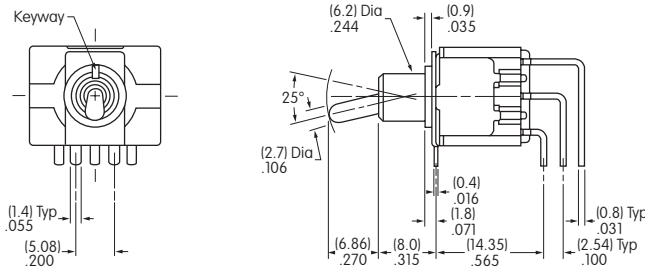

M2032S2A2G45

Four Pole

.100" (2.54mm) Vertical PC

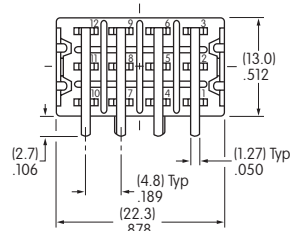
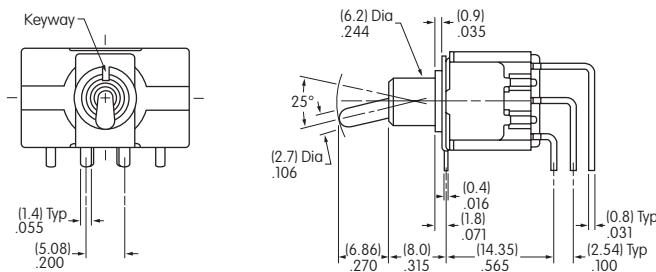

M2042S2A2G45

# General Specifications

## Electrical Capacity (Resistive Load)

<b>Power Level (silver):</b>	6A @ 125V AC or 3A @ 250V AC or 3A @ 30V DC	
<b>Logic Level (gold):</b>	0.4VA maximum @ 28V AC/DC maximum (Applicable Range 0.1mA ~ 0.1A @ 20mV ~ 28V)	
	Note: Find additional explanation of operating range in Supplement section.	

## Other Ratings

<b>Contact Resistance:</b>	10 milliohms maximum for silver; 20 milliohms maximum for gold	
<b>Insulation Resistance:</b>	1,000 megohms minimum @ 500V DC	
<b>Dielectric Strength:</b>	1,000V AC minimum between contacts for 1 minute minimum; 1,500V AC minimum between contacts & case for 1 minute minimum	
<b>Mechanical Life:</b>	50,000 operations minimum	
<b>Electrical Life:</b>	25,000 operations minimum	
<b>Nominal Operating Force:</b>	On-to-On Position	Off-to-On Position
	Single Pole	3.19N
	Double Pole	4.41N
		3.92N
		7.06N
<b>Angle of Throw:</b>	20°	

## Materials & Finishes

<b>Bushing:</b>	Brass with nickel plating
<b>Housing:</b>	Stainless steel
<b>Mounting Bracket:</b>	Steel with tin plating
<b>Movable Contacts:</b>	Silver alloy or silver alloy with gold plating
<b>Stationary Contacts:</b>	Silver with silver plating or copper or brass with gold plating
<b>Lamp Contacts:</b>	Phosphor bronze
<b>Base:</b>	Diallyl phthalate (UL94V-0)
<b>Switch Terminals:</b>	Copper with silver or gold plating
<b>Lamp Terminals:</b>	Brass with silver or gold plating

## Environmental Data

<b>Operating Temp Range:</b>	-10°C through +55°C (+14°F through +131°F)
<b>Humidity:</b>	90 ~ 95% humidity for 96 hours @ 40°C (104°F)
<b>Vibration:</b>	10 ~ 55Hz with peak-to-peak amplitude of 1.5mm traversing the frequency range & returning in 1 minute; 3 right angled directions for 2 hours
<b>Shock:</b>	50G (490m/s <sup>2</sup> ) acceleration (tested in 6 right angled directions, with 5 shocks in each direction)

## Installation

<b>Mounting Torque:</b>	1.47Nm (13 lb•in) for double nut; .67Nm (6 lb•in) for single nut
<b>Soldering Time &amp; Temp:</b>	Wave Soldering (PC version): See Profile B in Supplement section. Manual Soldering: See Profile B in Supplement section. Note: Lever must be in center position while soldering.
<b>Cleaning:</b>	PC mountable device is not process sealed. Hand clean locally using alcohol based solution.

## Standards & Certifications

<b>Flammability Standards:</b>	UL94V-0 base
<b>UL:</b>	<b>File No. E44145 - Recognized only when ordered with marking on switch.</b> Add "/U" to end of part number to order UL recognized switch. Single pole with synchronous circuits & single color LEDs & solder lug or PC recognized at 6A @ 125V AC.
<b>CSA:</b>	<b>File No. 023535_0_000 - Certified only when ordered with marking on switch.</b> Add "/C" to end of part number to order CSA certified switch. All single pole with synchronous circuits & single color LEDs certified at 6A @ 125V AC.

# Distinctive Characteristics

Industry's first LED illumination at tip of toggle switches.

Single color LEDs of red, yellow, and green, plus bicolor red/green, to meet varied design requirements.

LEDs can operate independently from or synchronously with switching operation.

Antijamming feature to protect contacts from damage due to excessive downward force on the toggle.

High torque bushing prevents the bushing from rotating or separating from the metal frame during installation.

Stainless steel frame resists corrosion.

Silver contacts are of specially composed alloy for hardness.

High insulating barriers protect against crossover in double pole devices.

Terminals are molded in and epoxy sealed to lock out flux, dust, and other contaminants.

1,500V dielectric strength between switch contacts and case is accomplished by clinching the frame away from the terminals.



Actual Size

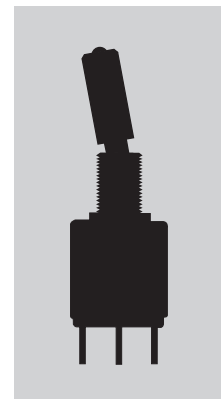

A  
Toggles

Rockers

Pushbuttons

Illuminated PB

Programmable

Key locks

Rotaries

Slides

Tactiles

Tilt

Touch

Indicators

Accessories

Supplement

### TYPICAL SWITCH ORDERING EXAMPLE

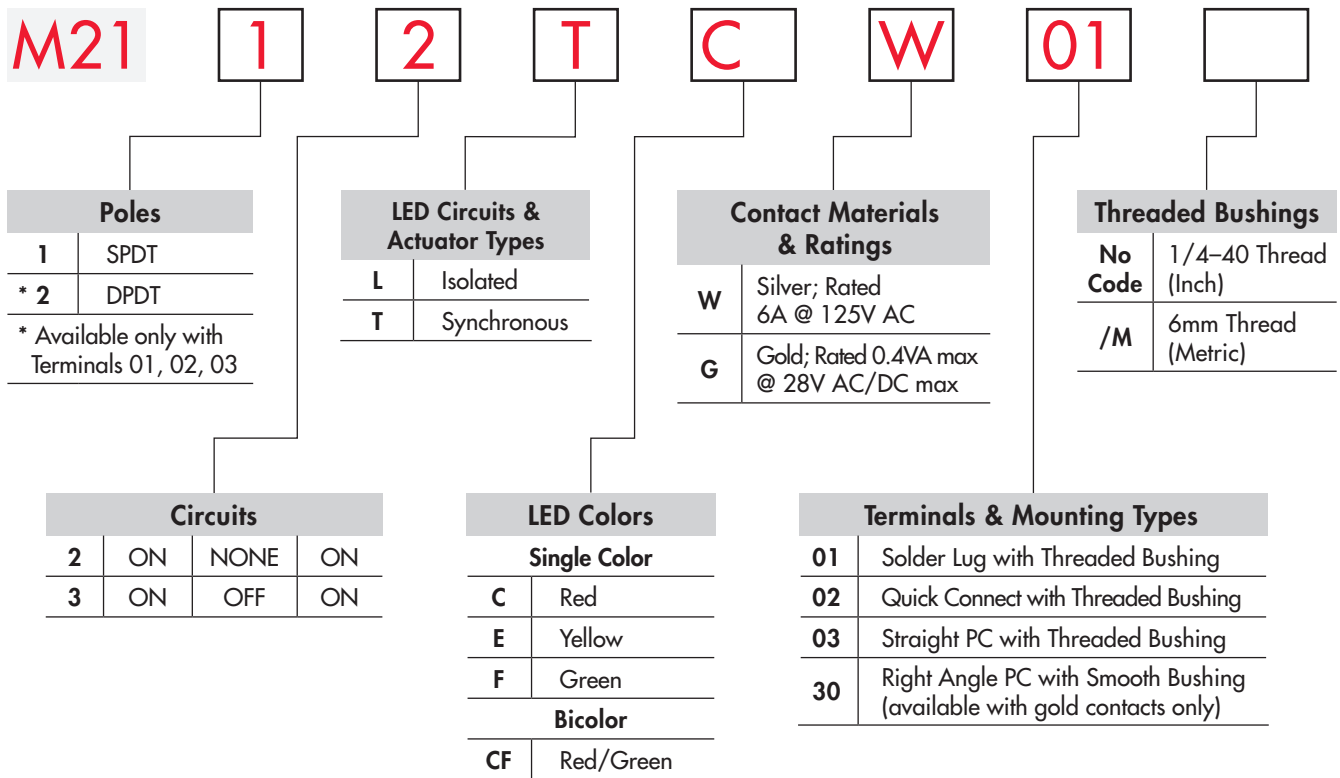

#### IMPORTANT:





Switches are supplied without UL & CSA marking unless specified.  
**UL & CSA recognized only when ordered with marking on the switch.**  
 Specific models, ratings, & ordering instructions are noted on the General Specifications page.

#### DESCRIPTION FOR TYPICAL ORDERING EXAMPLE

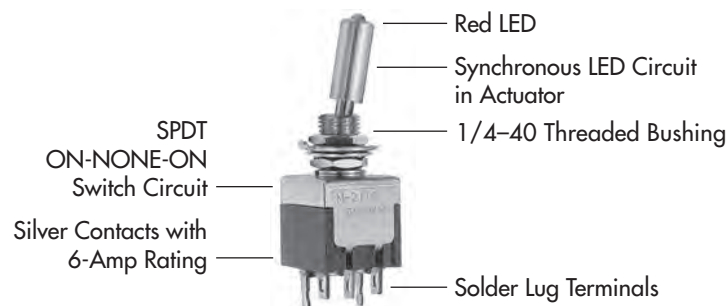
**M2112TCW01**



## POLES & CIRCUITS & LED ILLUMINATION

Model	Pole & Throw	Toggle Position & Terminal Numbers			Schematics
		Down 	Center 	Up 	
<b>M2112</b> <b>SPDT</b> Connected Power Terminals		ON 2-3	NONE NONE	ON 2-1	<p>Notes: Terminal numbers are not actually on the switch. LEDs require an external power source.</p> <p><b>Isolated Single Color LED</b></p> <p><b>Isolated Bicolor LED</b></p>
LED Circuit	<b>Isolated LEDs</b> (see schematics) Connected LED Terminals	ON 4-6	NONE NONE	ON 4-6	
	<b>Synchronous Single Color LED</b> Connected LED Terminals	ON 4-6	NONE NONE	OFF OPEN	
	<b>Synchronous Bicolor LED</b> Connected LED Terminals	Red 5-6	NONE NONE	Green 5-4	
<b>M2113</b> <b>SPDT</b> Connected Power Terminals		ON 2-3	OFF OPEN	ON 2-1	<p><b>Synchronous Single Color LED</b></p> <p><b>Synchronous Bicolor LED</b></p>
LED Circuit	<b>Isolated LEDs</b> (see schematics) Connected LED Terminals	ON 4-6	ON 4-6	ON 4-6	
	<b>Synchronous Single Color LED</b> Connected LED Terminals	ON 4-6	OFF OPEN	ON 4-6	
	<b>Synchronous Bicolor LED</b> Connected LED Terminals	Red 5-6	OFF OPEN	Green 5-4	
<b>M2122</b> <b>DPDT</b> Connected Power Terminals		ON 2-3 5-6	NONE NONE	ON 2-1 5-4	<p><b>Isolated Single Color LED</b></p> <p><b>Isolated Bicolor LED</b></p>
LED Circuit	<b>Isolated LEDs</b> (see schematics) Connected LED Terminals	ON 7-9	NONE NONE	ON 7-9	
	<b>Synchronous Single Color LED</b> Connected LED Terminals	ON 7-9	NONE NONE	OFF OPEN	
	<b>Synchronous Bicolor LED</b> Connected LED Terminals	Red 8-9	NONE NONE	Green 8-7	
<b>M2123</b> <b>DPDT</b> Connected Power Terminals		ON 2-3 5-6	OFF OPEN	ON 2-1 5-4	<p><b>Synchronous Single Color LED</b></p> <p><b>Synchronous Bicolor LED</b></p>
LED Circuit	<b>Isolated LEDs</b> (see schematics) Connected LED Terminals	ON 7-9	ON 7-9	ON 7-9	
	<b>Synchronous Single Color LED</b> Connected LED Terminals	ON 7-9	OFF OPEN	ON 7-9	
	<b>Synchronous Bicolor LED</b> Connected LED Terminals	Red 8-9	OFF OPEN	Green 8-7	

## LED COLORS & SPECIFICATIONS

The electrical specifications shown are determined at a basic temperature of 25°C. LED circuit is isolated and requires an external power source. If the source voltage exceeds the rated voltage, a ballast resistor is required. The resistor value can be calculated by using the formula in Supplement Section.

The LED is an integral part of the switch and not available separately.  Bicolor LED is translucent white when unlit.		Single Color			Bicolor	
		<b>C</b>	<b>E</b>	<b>F</b>	<b>CF</b>	Units
Color		Red	Yellow	Green	Red/Green	
Maximum Forward Current	$I_{FM}$	25	30	30	25	mA
Typical Forward Current	$I_F$	20	20	20	10	mA
Forward Voltage	$V_F$	2.1	2.1	2.1	1.7/2.0	V
Maximum Reverse Voltage	$V_{RM}$	4	4	4	—	V
Current Reduction Rate Above 25°C	$\Delta I_F$	0.33	0.40	0.40	0.33/0.33	mA/°C
Ambient Temperature Range		-10° ~ +55°C				

## LED CIRCUIT, TOGGLE, & MOUNTING TYPE COMBINATIONS



**Toggle with Isolated LED Circuit**



**Toggle with Synchronous LED Circuit**

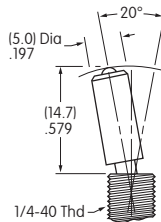

Threaded Bushing combines with Terminal codes 01, 02, & 03.

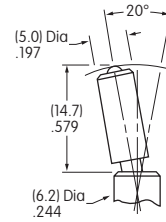

Smooth Bushing combines with Terminal code 30.

Max. Panel Thickness with Standard Hardware  
.102" (2.6mm)

Max. Panel Thickness without Locking Ring  
.134" (3.4mm)

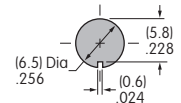
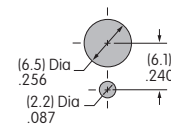

Finish: Brushed aluminum

Standard Hardware: 2 AT513H Hex Nuts, 1 AT507H Locking Ring, 1 AT509 Lockwasher Standard & optional hardware details in Accessories & Hardware section.

## TYPICAL SWITCH DIMENSIONS

### Solder Lug

### Single Pole

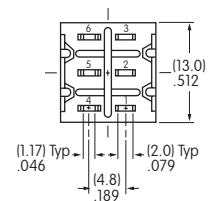
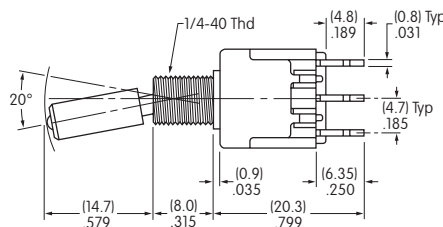
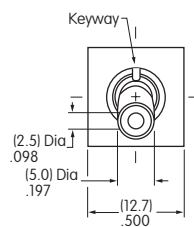

**M2112TCFW01**

Single color LED switch does not have terminal 5.



TYPICAL SWITCH DIMENSIONS

Double Pole

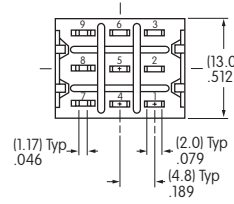
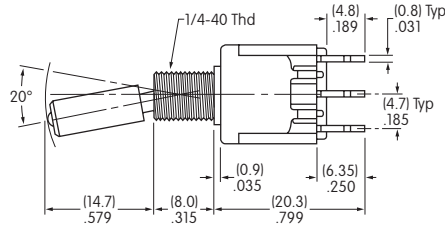
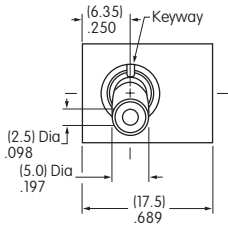

Solder Lug



Single color LED switch does not have terminal 8.

M2122TCFW01

Single Pole Only

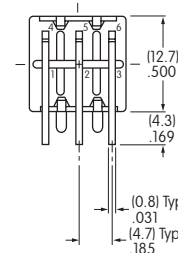
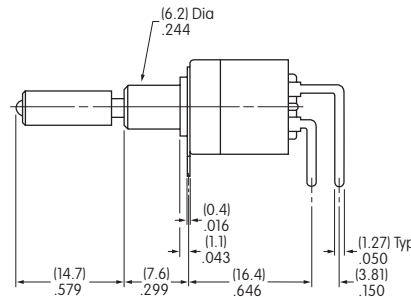
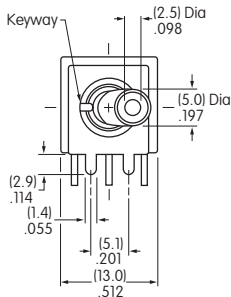

Right Angle PC



Single color LED switch does not have terminal 5.

Gold contact material only

M2112TCFG30

CONTACT MATERIALS & RATINGS



Silver over Silver

Power Level

6A @ 125V AC & 3A @ 250V AC



Gold over Brass or Copper

Logic Level

0.4VA maximum @ 28V AC/DC maximum

Complete explanation of operating range in Supplement section.

## TERMINALS

### 01 Solder Lug with Turret LED Terminal

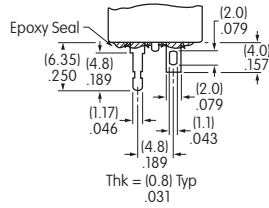

### 02 Quick Connect

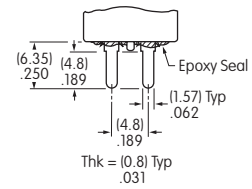

### 03 Straight PC with Turret LED Terminal

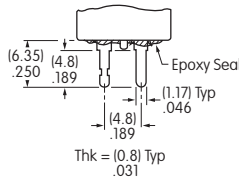

#### Single Pole

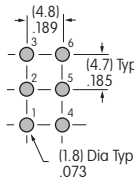

Single color LED & isolated bicolor LED switches do not have terminal 5.

#### Double Pole

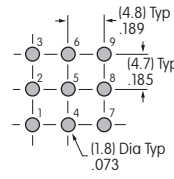

Single color LED & isolated bicolor LED switches do not have terminal 8.

### 30 Right Angle PC

LED terminals only available in brass with silver plating

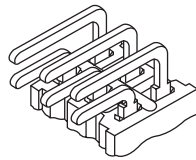

#### Single Pole

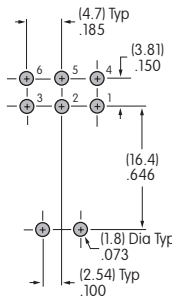

Single color LED & isolated bicolor LED switches do not have terminal 5.

## STANDARD MOUNTING HARDWARE

### AT513H Hexagon Nut (2 per switch)

Material: Brass with nickel plating

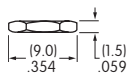
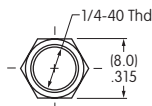

### AT507H Locking Ring (1 per switch)

Material: Steel with chromate over zinc

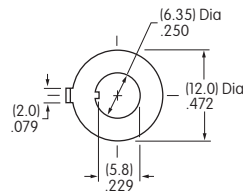

### AT509 Lockwasher (1 per switch)

Material: Steel with chromate over zinc

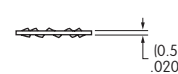
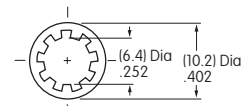

**Optional Hardware:** Knurled nuts, dress nuts, and ON-OFF plates are available; see details in Accessories & Hardware section.



## General Specifications

**Electrical Capacity (Resistive Load)**

<b>Power Level (silver):</b>	6A @ 125V AC or 3A @ 250V AC; 4A @ 30V DC (On-On circuit) & 3A @ 30V DC (all other circuits)
<b>Logic Level (gold):</b>	0.4VA maximum @ 28V AC/DC maximum (Applicable Range 0.1mA ~ 0.1A @ 20mV ~ 28V)
<b>Logic/Power Level: (gold over silver)</b>	Combines silver & gold ratings

Note: Find additional explanation of dual rating & operating range in Supplement section.

**Other Ratings**

<b>Contact Resistance:</b>	10 milliohms maximum for silver; 20 milliohms maximum for gold
<b>Insulation Resistance:</b>	1,000 megohms minimum @ 500V DC
<b>Dielectric Strength:</b>	1,000V AC minimum between contacts for 1 minute minimum; 1,500V AC minimum between contacts & case for 1 minute minimum
<b>Mechanical Life:</b>	100,000 operations minimum
<b>Electrical Life:</b>	25,000 operations minimum for silver; 50,000 operations minimum for gold
<b>Contact Timing:</b>	Nonshorting (break-before-make)
<b>Angle of Throw:</b>	26°

**Materials & Finishes**

<b>Toggle/Lever:</b>	Brass with nickel plating
<b>Support Bracket:</b>	Brass with tin plating
<b>Bushing/Housing:</b>	Glass fiber reinforced polyamide (UL94V-0)
<b>Sealing Ring:</b>	Nitrile butadiene rubber
<b>Base:</b>	Glass fiber reinforced polyamide (UL94V-0)
<b>Movable Contacts:</b>	Silver alloy with silver plating (code W); copper or phosphor bronze with gold plating (code G); or silver alloy with gold plating (code A)
<b>Stationary Contacts:</b>	Silver alloy with silver plating (code W); copper or brass with gold plating (code G); or silver alloy with gold plating (code A)
<b>Terminals:</b>	Copper or brass with silver or gold plating

**Environmental Data**

<b>Operating Temp Range:</b>	-30°C through +85°C (-22°F through +185°F)
<b>Humidity:</b>	90 ~ 95% humidity for 96 hours @ 40°C (104°F)
<b>Vibration:</b>	10 ~ 55Hz with peak-to-peak amplitude of 1.5mm traversing the frequency range & returning in 1 minute; 3 right angled directions for 2 hours
<b>Shock:</b>	50G (490m/s <sup>2</sup> ) acceleration (tested in 6 right angled directions, with 5 shocks in each direction)

**PCB Processing**

<b>Soldering:</b>	Wave Soldering Recommended: See Profile B in Supplement section. Manual Soldering: See Profile B in Supplement section.
<b>Cleaning:</b>	Automated cleaning. See Cleaning specifications in Supplement section.

**Standards & Certifications**

<b>Flammability Standards:</b>	UL94V-0 rated bushing/housing & base
<b>UL:</b>	<b>File No. E44145 - Recognized only when ordered with marking on switch.</b> Add "/U" or "/CUL" before first dash in part number to order UL recognized switch. All models recognized at 6A @ 125V AC, 3A @ 250V AC, & 4A @ 30V DC or 0.4A @ 28V DC.
<b>CSA:</b>	<b>File No. 023535_0_000 - Certified only when ordered with marking on switch.</b> Add "/C" to end of part number to order CSA certified switch. All models certified at 6A @ 125V AC, 3A @ 250V AC, & 4A @ 30V DC.

# Distinctive Characteristics

Antijamming actuator design protects against mechanism damage from downward force on the toggle.

Single unit construction of the bushing and top of the housing gives protection from cleaning fluids or other liquids.

O-ring surrounding actuator at top of bushing interior prevents liquids from reaching switch mechanism.

Ultrasonic welding of upper and lower housing seals out contaminants and allows automated soldering and cleaning.

Terminals are epoxy sealed to prevent entry of flux, solvents, and other contaminants.

Bracketed models have crimped legs to ensure secure PC mounting and prevent dislodging during automated soldering.

Logic level and power capabilities are available to suit varying applications.

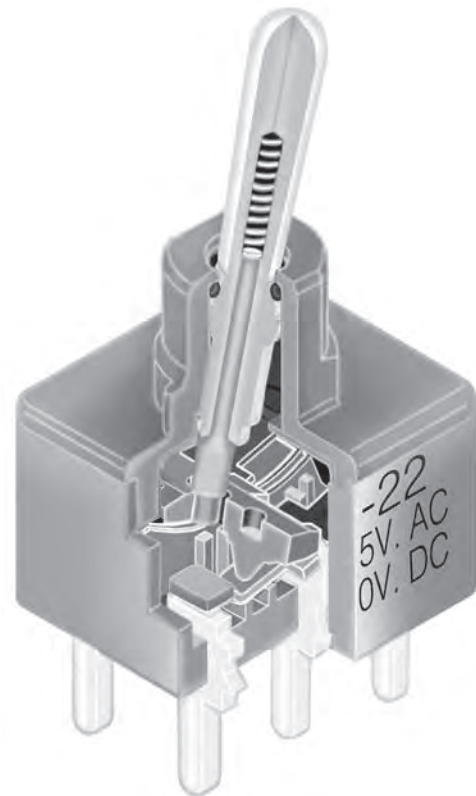

Actual Size

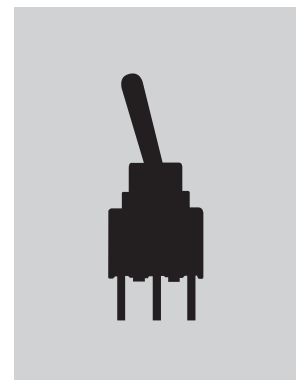

- A Toggles
- Rockers
- Pushbuttons
- Illuminated PB
- Programmable
- Key locks
- Rotaries
- Slides
- Tactiles
- Tilt
- Touch
- Indicators
- Accessories
- Supplement

### TYPICAL SWITCH ORDERING EXAMPLE

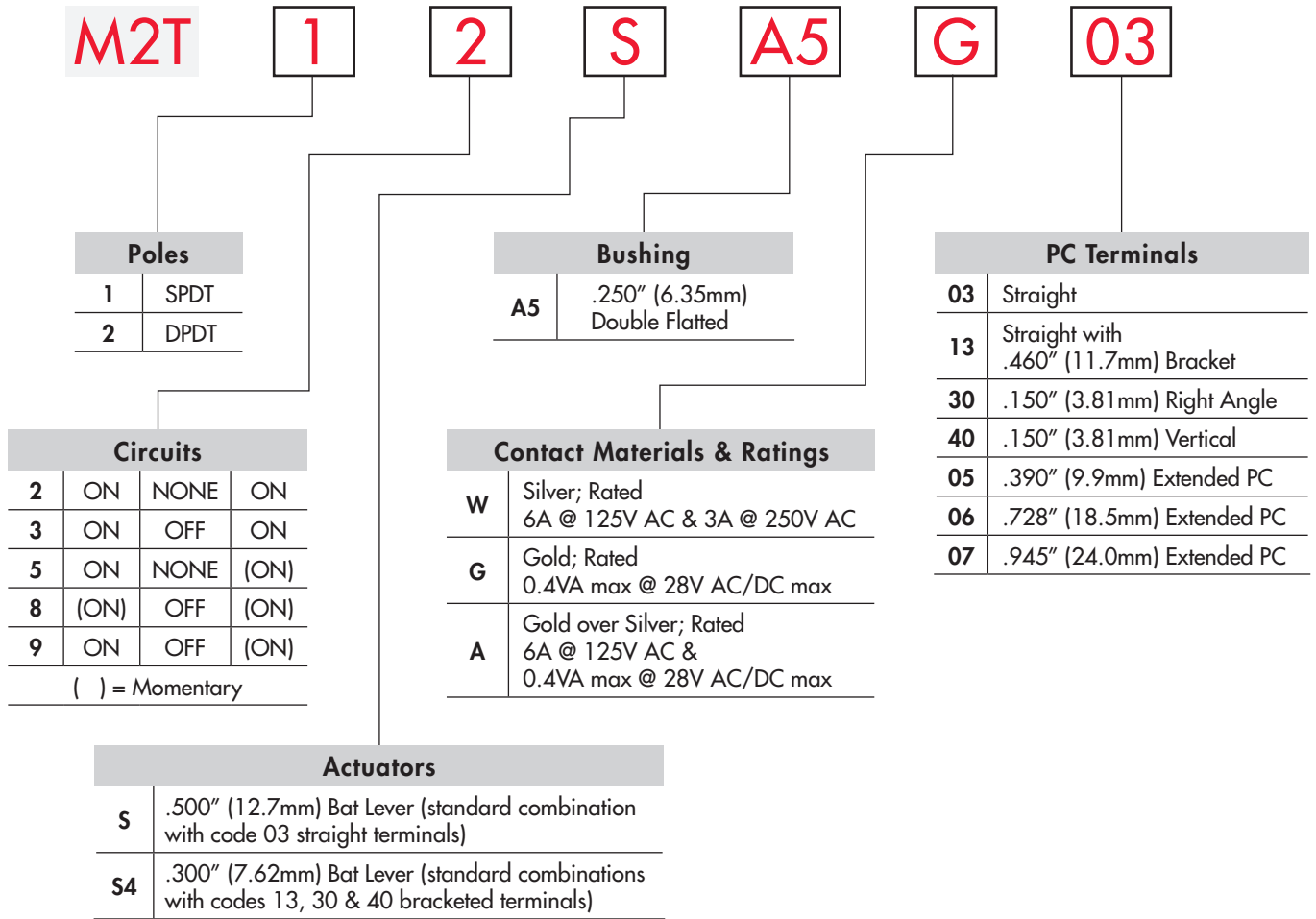

#### IMPORTANT:



Switches are supplied without UL, cULus & CSA marking unless specified.  
**UL, cULus & CSA recognized only when ordered with marking on the switch.**  
 Specific models, ratings & ordering instructions are noted on the General Specifications page.

#### DESCRIPTION FOR TYPICAL ORDERING EXAMPLE

### M2T12SA5G03

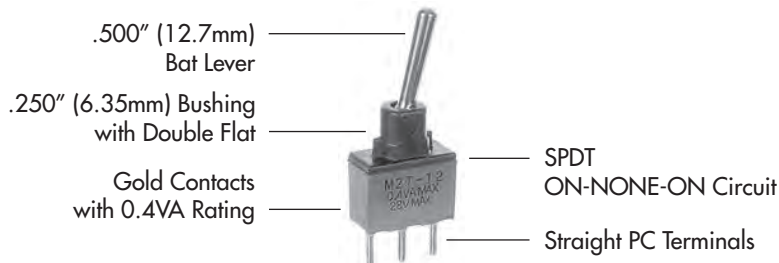

## POLES & CIRCUITS

Pole	Model	Toggle Position ( ) = Momentary			Connected Terminals			Throw & Schematics
		Down	Center	Up	Down	Center	Up	
								Note: Terminal numbers are not actually on the switch.
SP	M2T12 M2T13 M2T15 M2T18 M2T19	ON ON ON (ON) ON	NONE OFF NONE OFF OFF	ON ON (ON) (ON) (ON)	2-3	OPEN	2-1	SPDT 
DP	M2T22 M2T23 M2T25 M2T28 M2T29	ON ON ON (ON) ON	NONE OFF NONE OFF OFF	ON ON (ON) (ON) (ON)	2-3 5-6	OPEN	2-1 5-4	DPDT 

## ACTUATORS

**S** .500" (12.7mm)  
Bat Lever

Material:  
Nickel over Brass

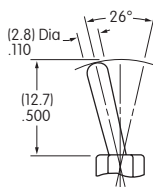

**S4** .300" (7.62mm)  
Bat Lever

Material:  
Nickel over Brass

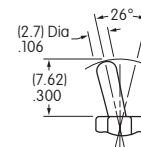

**Standard Combinations:** S Bat Lever with straight terminals (code 03) with silver or gold contacts.

**Standard Combinations:** S4 Bat Lever with bracketed terminals (codes 13, 30, 40) with silver or gold contacts.

## BUSHING

**A5** .250" (6.35mm) Double Flatted

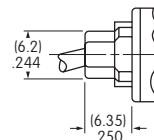
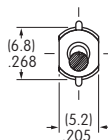

## CONTACT MATERIALS & RATINGS

**W** Silver over Silver **Power Level** 6A @ 125V AC & 3A @ 250V AC

**G** Gold over Brass or Copper **Logic Level** 0.4VA maximum @ 28V AC/DC maximum  
Complete explanation of operating range in Supplement section.

**A** Gold over Silver **Power Level or Logic Level** 6A @ 125V AC or 0.4VA maximum @ 28V AC/DC maximum

Note: This dual rated option is suitable when two or more identical switches are used in logic and in power circuits within the same application. See Supplement section for complete explanation of dual rating and operating range.

## PC TERMINALS

### 03 Straight

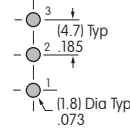
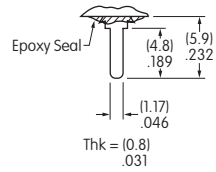

Single Pole

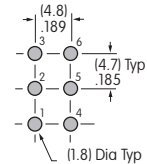

Double Pole

### 13 Straight with .460" (11.7mm) Bracket

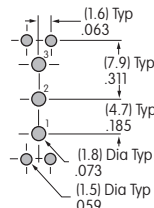
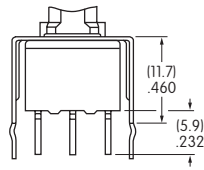

Single Pole

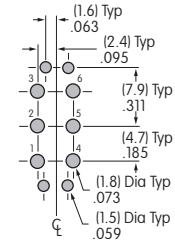

Double Pole

### 30 .150" (3.81mm) Right Angle

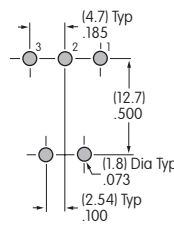
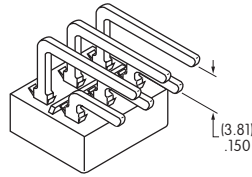

Single Pole

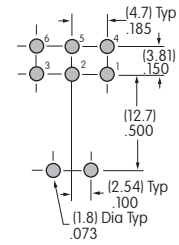

Double Pole

### 40 .150" (3.81mm) Vertical

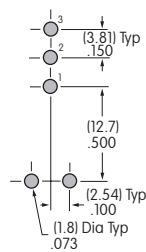
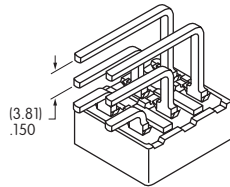

Single Pole

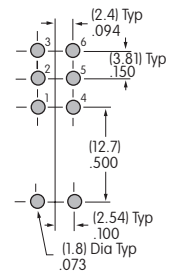

Double Pole

### 05 .390" (9.9mm) Extended PC

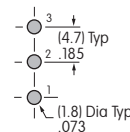
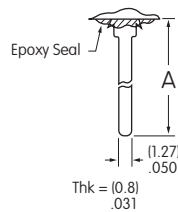

Single Pole

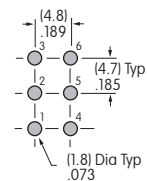

Double Pole

### 06 .728" (18.5mm) Extended PC

### 07 .945" (24.0mm) Extended PC

Dimension A = terminal lengths as shown beside the terminal codes at the left.



TYPICAL SWITCH DIMENSIONS

Single Pole

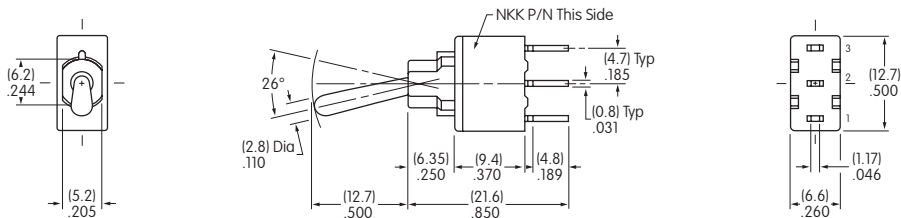

Actuator in Down Position

Straight PC



M2T12SA5G03

Double Pole

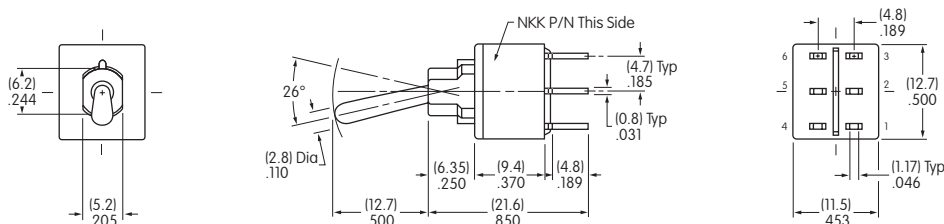

Actuator in Down Position

Straight PC



M2T22SA5G03

Single & Double Pole

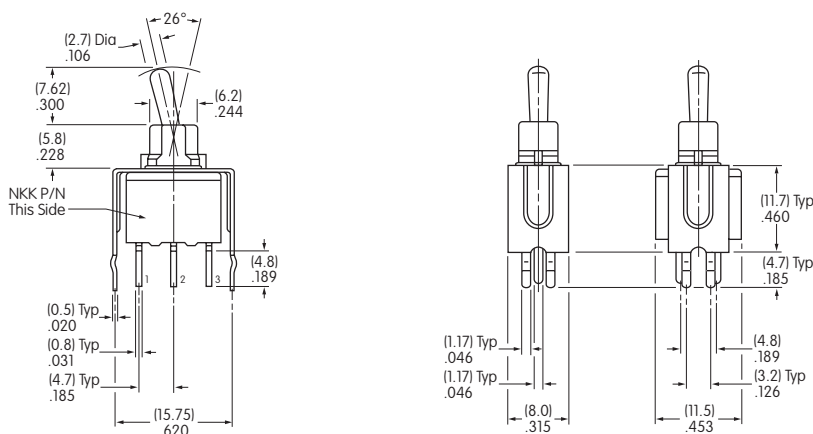

Actuator in Down Position

Straight PC • Bracket



M2T12SA4A5G13

- A Toggles
- Rockers
- Pushbuttons
- Illuminated PB
- Programmable
- Key locks
- Rotaries
- Slides
- Tactiles
- Tilt
- Touch
- Indicators
- Accessories
- Supplement

## TYPICAL SWITCH DIMENSIONS

### Right Angle PC

### Single Pole

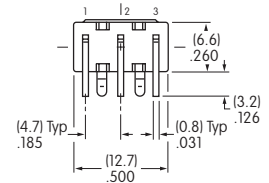
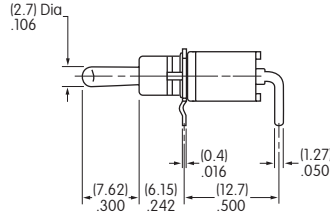
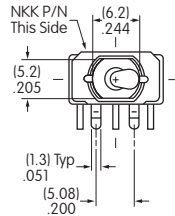

**M2T12S4A5G30**

Actuator in Down Position

### Right Angle PC

### Double Pole

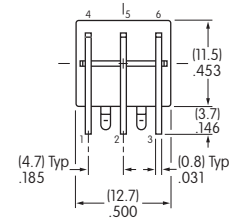
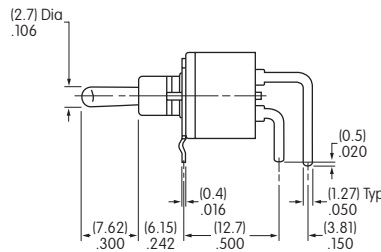
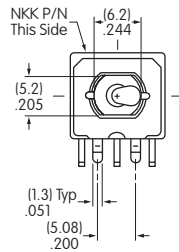

**M2T22S4A5G30**

Actuator in Down Position

### Vertical PC

### Single Pole

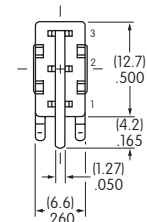
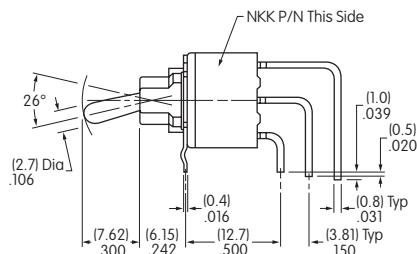
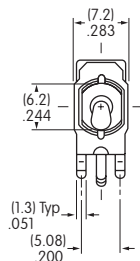

**M2T12S4A5G40**

Actuator in Down Position

TYPICAL SWITCH DIMENSIONS

Double Pole

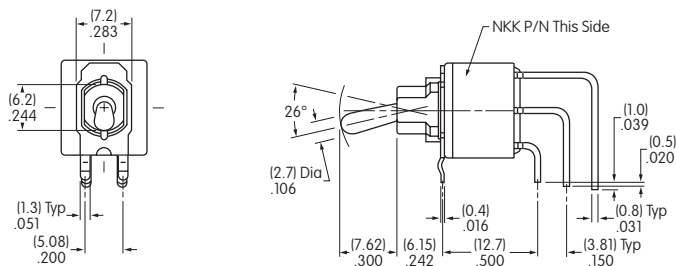

Actuator in Down Position

Vertical PC

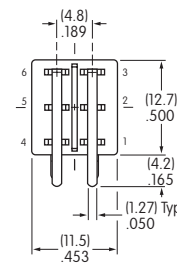

M2T22S4A5G40

HANDLING PRECAUTION

When an application employs M2T model with silver contacts, 5 to 6A @ 125V AC, and the switch will be actuated 100 or more times per day, note these instructions:

Peel off the film seal on the switch body situated over the part number after cleaning.

- A Toggles
- Rockers
- Pushbuttons
- Programmable Illuminated PB
- Key locks
- Rotaries
- Slides
- Tactiles
- Tilt
- Touch
- Indicators
- Accessories
- Supplement

## General Specifications

**Electrical Capacity**

<b>Resistive Load:</b>	10A @ 125V AC or 6A @ 250V AC
<b>Motor Load:</b>	400W @ 125V AC
<b>Lamp Load:</b>	2A @ 125V AC for On-Off-On circuit & 3A @ 125V AC for other circuits

**Other Ratings**

<b>Contact Resistance:</b>	10 milliohms maximum
<b>Insulation Resistance:</b>	1,000 megohms minimum @ 500V DC
<b>Dielectric Strength:</b>	2,000V AC minimum between contacts for 1 minute minimum; 4,000V AC minimum between contacts & case for 1 minute minimum
<b>Mechanical Life:</b>	100,000 operations minimum
<b>Electrical Life:</b>	25,000 operations minimum
<b>Angle of Throw:</b>	25°

**Materials & Finishes**

<b>Toggle Cap:</b>	Polypropylene
<b>Lever:</b>	Brass with chrome plating
<b>Bushing:</b>	Brass with nickel plating
<b>Frame:</b>	Stainless steel
<b>Case/Base:</b>	Diallyl phthalate resin (UL94V-0)
<b>Movable Contacts:</b>	Silver alloy with silver plating
<b>Stationary Contacts:</b>	Pure silver with silver plating
<b>Terminals:</b>	Copper with silver plating

**Environmental Data**

<b>Operating Temp Range:</b>	-10°C through +85°C (+14°F through +185°F)
<b>Humidity:</b>	90 ~ 95% humidity for 96 hours @ 40°C (104°F)
<b>Vibration:</b>	10 ~ 55Hz with peak-to-peak amplitude of 1.5mm traversing the frequency range & returning in 1 minute; 3 right angled directions for 2 hours
<b>Shock:</b>	50G (490m/s <sup>2</sup> ) acceleration (tested in 6 right angled directions, with 5 shocks in each direction)

**Installation**

<b>Soldering Time &amp; Temp:</b>	Wave Soldering Recommended (Straight PC): See Profile A in Supplement section. Manual Soldering: See Profile A in Supplement section.
<b>Cleaning:</b>	These devices are not process sealed. Hand clean locally using alcohol based solution.

**Standards & Certifications**

<b>Flammability Standards:</b>	UL94V-0 rated case/base
<b>UL:</b>	<b>File No. E44145 - Recognized only when ordered with marking on switch.</b> Add "/U" or "/CUL" to end of part number to order UL recognized switch. All models recognized at 10A @ 125V AC & 6A @ 250V AC.
<b>CSA:</b>	<b>File No. 023535_0_000 - Certified only when ordered with marking on switch.</b> Add "/C" to end of part number to order CSA certified switch. All models certified at 10A @ 125V AC & 6A @ 250V AC.
<b>VDE:</b>	<b>License No. 119174</b> All models approved at 10A @ 125V AC & 6A @ 250V AC. Marking on switch is standard. All models meet EN 61058-1 standard.

# Distinctive Characteristics

Meets EN 61058-1 standard.

High torque bushing construction prevents rotation or separation from frame during installation.

Stainless steel frame resists corrosion and increases environmental safety.

Case/base of heat resistant resin meets UL94V-0 flammability standard.

Contacts of special silver alloy resist arcing and guarantee stable electrical contact and long life.

High insulating barriers increase isolation of circuits in double pole devices and provide added protection to contact points.

Prominent external insulating barriers increase insulation resistance and dielectric strength.

Epoxy sealed terminals prevent entry of flux, solvents, and other contaminants.

Clinching of the frame to the case well above the base and terminals provides 4,000V dielectric strength.

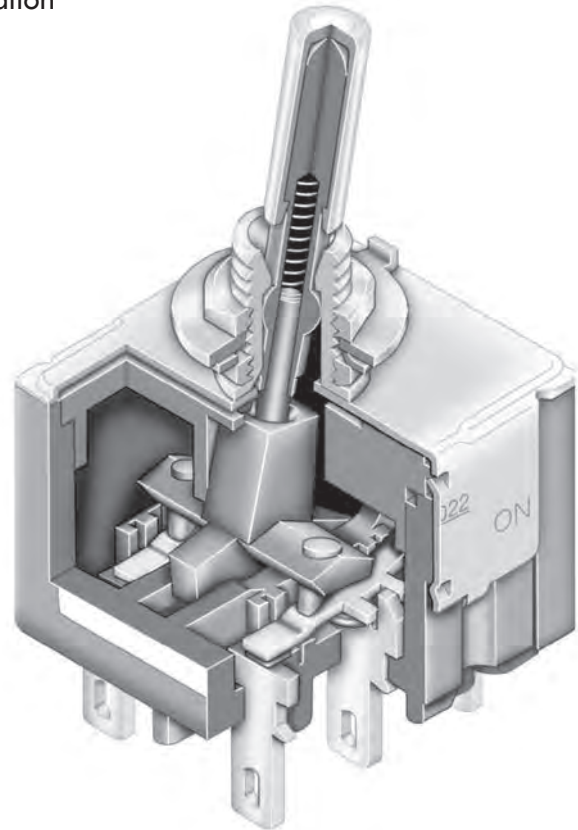

Actual Size

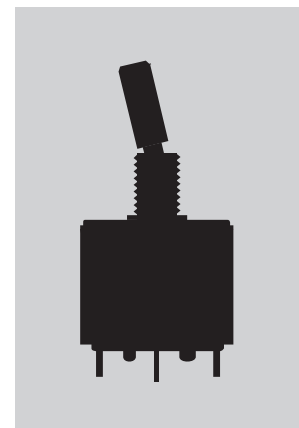

- A Toggles
- Rockers
- Pushbuttons
- Illuminated PB
- Programmable
- Key locks
- Rotaries
- Slides
- Tactiles
- Tilt
- Touch
- Indicators
- Accessories
- Supplement

### TYPICAL SWITCH ORDERING EXAMPLE

P20

22

B



Poles & Circuits				
11	SPST	ON	NONE	OFF
12	SPDT	ON	NONE	ON
13	SPDT	ON	OFF	ON
21	DPST	ON	NONE	OFF
22	DPDT	ON	NONE	ON
23	DPDT	ON	OFF	ON

Toggles & Bushings	
No Code	.512" (13.0mm) White Cap with 6mm Bushing
E	.450" (11.4mm) Flatted with 6mm Bushing
B	.689" (17.5mm) Large Bat with 12mm Bushing
D	.748" (19.0mm) White Capped Column with 12mm Bushing

Terminals	
No Code	Solder Lug
P	Straight PC
Z	.187" (4.75mm) Quick Connect

### DESCRIPTION FOR TYPICAL ORDERING EXAMPLE

**P2022B**

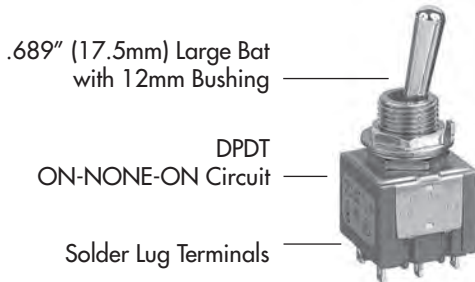

### IMPORTANT:

VDE is marked on all models. Switches are supplied without UL, cULus & CSA marking unless specified. **UL, cULus & CSA recognized only when ordered with marking on the switch.** Specific models, ratings, & ordering instructions are noted on the General Specifications page.



### POLES & CIRCUITS

Pole	Model	Toggle Position			Connected Terminals			Throw & Schematics
		Down <small>Keyway</small>	Center	Up	Down <small>Keyway</small>	Center	Up	
SP	P2011	ON	NONE	OFF	1-1b	OPEN	OPEN	SPST 
SP	P2012 P2013	ON ON	NONE OFF	ON ON	1-1b	OPEN	1-1a	SPDT 
DP	P2021	ON	NONE	OFF	1-1b 2-2b	OPEN	OPEN	DPST 
DP	P2022 P2023	ON ON	NONE OFF	ON ON	1-1b 2-2b	OPEN	1-1a 2-2a	DPDT 

TOGGLES & BUSHINGS

No Code

.512" (13.0mm)  
White Cap with  
6mm Bushing

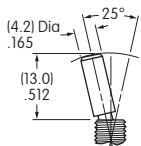

E

.450" (11.4mm)  
Flatted with  
6mm Bushing

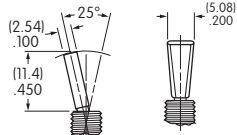

B

.689" (17.5mm)  
Large Bat with  
12mm Bushing

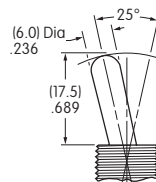

D

.748" (19.0mm)  
White Capped Column  
with 12mm Bushing

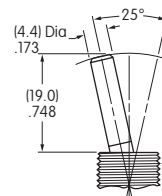

Panel Cutouts

Panel Thickness  
with Keyway  
.134" (3.4mm)  
maximum

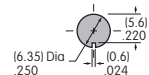

Panel Thickness  
with Locking Ring  
.102" (2.6mm)  
maximum

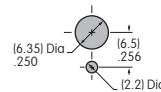

Panel Thickness  
with Keyway  
.256" (6.5mm)  
maximum

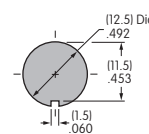

Panel Thickness  
with Locking Ring  
.217" (5.5mm)  
maximum

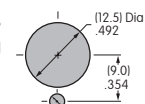

Standard Hardware

For 6mm Bushing: 1 Locking Ring AT507M, 1 Internal Tooth Lockwasher AT509, 2 Hex Nuts AT513M

For 12mm Bushing: 1 Hex Face Nut AT503M, 1 Locking Ring AT506M, 1 Internal Tooth Lockwasher AT508, 1 Hex Mounting Nut AT527M

Optional Splashproof Boot Assemblies (for code B): AT401 & AT4181 boots plus hex nut & o-ring; see Accessories & Hardware section.

TERMINALS

No Code

Solder Lug

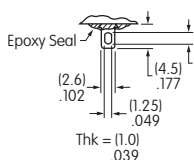

Z

.187" (4.75mm)  
Quick Connect

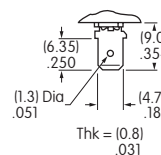

P

Straight PC

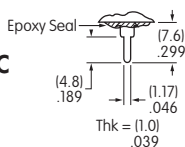

SPST

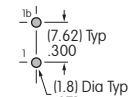

SPDT

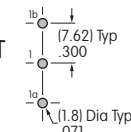

DPST

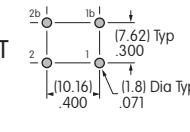

DPDT

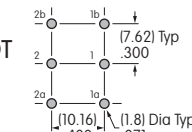

TYPICAL SWITCH DIMENSIONS

P2011, P2012, P2013

6mm Bushing

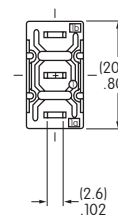
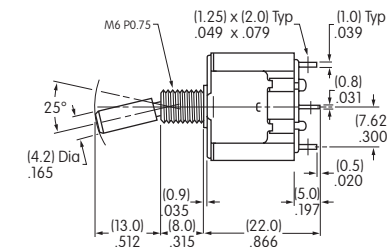
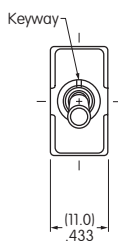

P2011 models do not have terminal 1a.

P2012

P2021B, P2022B, P2023B

12mm Bushing

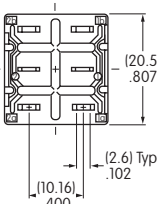
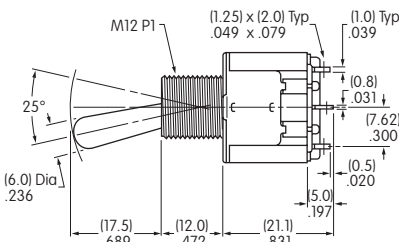

P2021 models do not have terminals 1a & 2a.

P2022B

## Contents for Standard Size Toggles



Low Capacity ..... Page A101

5A Power Level  
Solder Lug Terminals  
Bushing Mount  
Double Pole



Medium Capacity ..... Page A103

15~20A Power Level  
Solder Lug, Quick Connect Terminals  
Bushing Mount  
Single & Double Pole



Medium/High Capacity .... Page A108

15~25A Power Level  
Solder Lug, Screw Lug, Quick Connect Terminals  
Bushing Mount  
One through Four Pole



High Capacity ..... Page A119

30~50A Power Level  
Screw Lug Terminals  
Bushing Mount or Mounting Screws  
Double Pole & Three Pole



## GENERAL SPECIFICATIONS FOR S100s

A  
Toggles

### Electrical Capacity (Resistive & Inductive Load)

**Power Level:** Shown in the following table

Rockers

### Other Ratings

**Contact Resistance:** 10 milliohms maximum  
**Insulation Resistance:** 200 megohms minimum @ 500V DC  
**Dielectric Strength:** 1,500V AC minimum for 1 minute minimum  
**Mechanical Life:** 30,000 operations minimum  
**Electrical Life:** 10,000 operations minimum  
**Operating Temp Range:** -10°C through +70°C (+14°F through +158°F)

Pushbuttons

Illuminated PB

### Materials & Finishes

**Toggle:** Brass with chrome plating  
**Bushing:** Brass with chrome or nickel plating  
**Case:** Phenolic resin  
**Case Cover:** Steel with zinc plating  
**Movable Contactor Plate:** Copper with silver plating  
**Movable & Stationary Contacts:** Silver alloy plus copper with silver plating  
**Terminals:** Copper with silver plating

Programmable

Keylocks

### Environmental Data

**Operating Temp Range:** -10°C through +70°C (+14°F through +158°F)

Rotaries

### Installation

**Mounting Torque:** 2.94Nm (26 lb·in) for double nut  
**Soldering Time & Temperature:** Manual Soldering: See Profile A in Supplement section.

Slides

### Standards & Certifications

**CSA:** File No. 023535\_0\_000 - Certified only when ordered with marking on switch.  
 Add "/C" to end of part number to order CSA certified switch.  
 Certified at 5A @ 125V AC & 2A @ 250V AC.

Tactiles

Tilt





Touch

Indicators

Accessories

Supplement

## DOUBLE POLE WITH SOLDER LUG

* CSA certified only when ordered with marking on switch (see General Specs)			Toggle Position/Connected Terminals				Electrical Capacity				Angle of Throw
Model	* Approvals		Pole & Throw	Down 	Center 	Up 	Resistive			Inductive	
							AC 125V	AC 250V	DC 30V	AC 125V PF 0.6	
S114	—	✓	DPST	ON 2-1 5-4	NONE	OFF —	5A	2A	5A	3A	25°
S116	—	✓	DPDT	ON 2-1 5-4	NONE	ON 2-3 5-6	5A	2A	5A	3A	25°
S116R	—	—	DPDT	ON 2-1 5-4	NONE	ON 2-3 5-6	5A	2A	5A	3A	25°

Throw & Schematics:

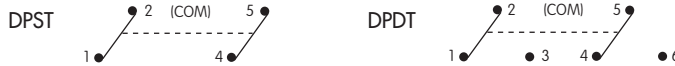

Note: Terminal numbers are actually on the switch

**Notes:** Standard Hardware: AT504M Knurled Nut, AT508 Lockwasher, AT527M Backup Hex Nut. See Accessories & Hardware section.  
Optional Splashproof Boot Assemblies (only for bat lever models): AT401 & AT4181 boots plus hex nut and o-ring. See Accessories & Hardware section.

### S114 & S116

### S116R Black Polyamide Paddle

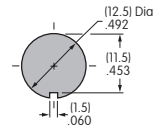
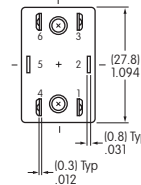
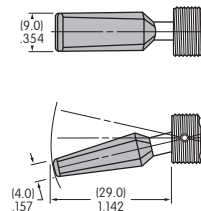
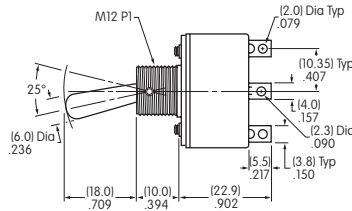
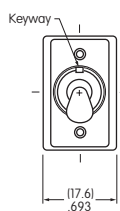

**S116**

S114 does not have terminals 3 & 6

Maximum Panel Thickness: .158" (4.0mm)

## GENERAL SPECIFICATIONS FOR S1 ~ S29

A  
Toggles

### Electrical Capacity (Resistive & Inductive Load)

**Power Level:** Shown in the following tables

Rockers

### Other Ratings

**Contact Resistance:** 10 milliohms maximum  
**Insulation Resistance:** 1,000 megohms minimum @ 500V DC  
**Dielectric Strength:** 2,000V AC minimum for 1 minute minimum  
**Mechanical Life:** 30,000 operations minimum for S5AW, S8AW, S9AW, S25AW, S28AW, S29AW  
 50,000 operations minimum for all other models  
**Electrical Life:** 25,000 operations minimum  
**Angle of Throw ( $\alpha$ ):** Shown in tables on following pages

Pushbuttons

Illuminated PB

### Materials & Finishes

**Toggle:** Brass with chrome plating  
**Bushing:** Brass with chrome plating  
**Case:** Phenolic resin  
**Case Cover:** Steel with zinc plating  
**Movable Contactor:** Copper with silver plating  
**Movable Contacts:** Silver alloy capped on copper with silver plating  
**Stationary Contacts:** Silver alloy capped on copper with silver plating  
**Terminals:** Brass with tin plating

Programmable

Keylocks

Rotaries

### Environmental Data

**Operating Temp Range:** -30°C through +70°C (-22°F through +158°F) for Splashproof models;  
 -10°C through +70°C (+14°F through +158°F) for all other models  
**Sealing:** Splashproof & lever lock panel seal models meet IP67 standard

Slides

### Installation

**Mounting Torque:** 1.47Nm (13 lb•in) for single nut on AW & AL models  
 2.94Nm (26 lb•in) for double nut on other models  
**Maximum Panel Thickness:** Shown beneath panel cutout in switch dimension drawings  
**Soldering Time & Temperature:** Manual Soldering: See Profile A in Supplement section.

Tactiles

Tilt

### Standards & Certifications

**UL:** **File No. E44145 - Recognized only when ordered with marking on switch.**  
 Add "/U" or "/CUL" to end of part number to order UL recognized switch.  
 UL or cULus recognition designated beside part numbers on following pages.  
 See Supplement section to find UL or cULus rating details.

Touch

**CSA:** **File No. 023535\_0\_000 - Certified only when ordered with marking on switch.**  
 Add "/C" to end of part number to order CSA certified switch.  
 CSA certification designated beside part numbers on following pages.  
 See Supplement section to find CSA rating details.



Indicators



Accessories

Supplement

Toggles **A**

## SINGLE POLE WITH SOLDER LUG



* UL, cULus & CSA recognized only when ordered with marking on switch (see General Specs)				Toggle Position/Connected Terminals				Electrical Capacity				
Model	* Approvals			Pole & Throw	Down	Center	Up	Resistive			Inductive	Angle of Throw
	UL	cULus	CSA		Keyway 			AC 125V	AC 250V	DC 30V	AC 125V PF 0.6	
S1A	✓	✓	✓	SPST	ON 1-3	NONE	OFF —	15A	6A	20A	8A	25°
S2A	✓	✓	✓	SPDT	ON 2-3	NONE	ON 2-1	15A	6A	20A	8A	25°
S3A	✓	✓	✓	SPDT	ON 2-3	OFF	ON 2-1	15A	6A	20A	8A	25°

**Throw & Schematics:** SPST  INTERNAL CONNECTION  Note: Terminal numbers are actually on the switch

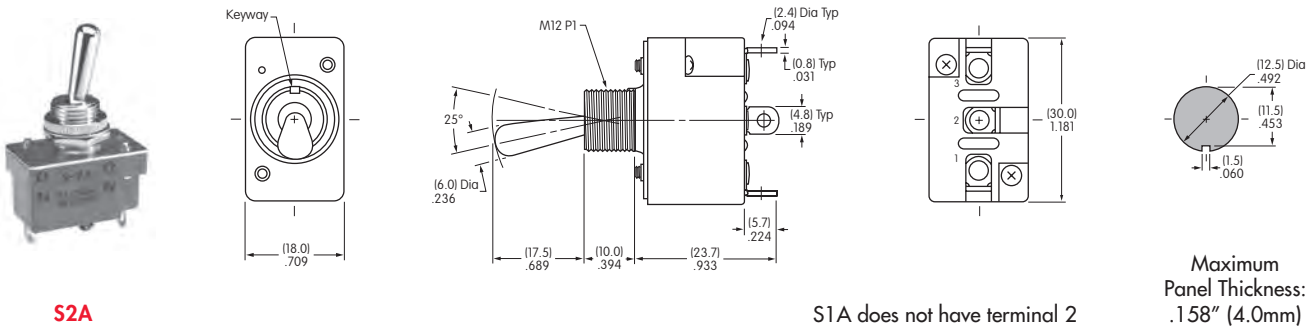
**Notes:** Standard Hardware: AT504M Knurled Nut, AT508 Lockwasher, AT527M Backup Hex Nut. See Accessories & Hardware section.  
Optional Splashproof Boot Assemblies: AT401 & AT4181 boots plus hex nut & o-ring. See Accessories & Hardware section.



## DOUBLE POLE WITH SOLDER LUG

* UL, cULus & CSA recognized only when ordered with marking on switch (see General Specs)				Toggle Position/Connected Terminals				Electrical Capacity				
Model	* Approvals			Pole & Throw	Down	Center	Up	Resistive			Inductive	α = Angle of Throw
	UL	cULus	CSA		Keyway 			AC 125V	AC 250V	DC 30V	AC 125V PF 0.6	
S21A	—	—	—	DPST	ON 1-3 4-6	NONE	OFF —	15A	15A	15A	8A	21°
S6A	✓	✓	✓	DPDT	ON 2-3 5-6	NONE	ON 2-1 5-4	20A	10A	20A	8A	21°
S7A	—	—	✓	DPDT	ON 2-3 5-6	OFF	ON 2-1 5-4	20A	10A	20A	8A	28°

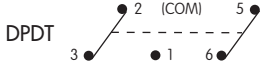

**Throw & Schematics:** DPST  INTERNAL CONNECTION  Note: Terminal numbers are actually on the switch

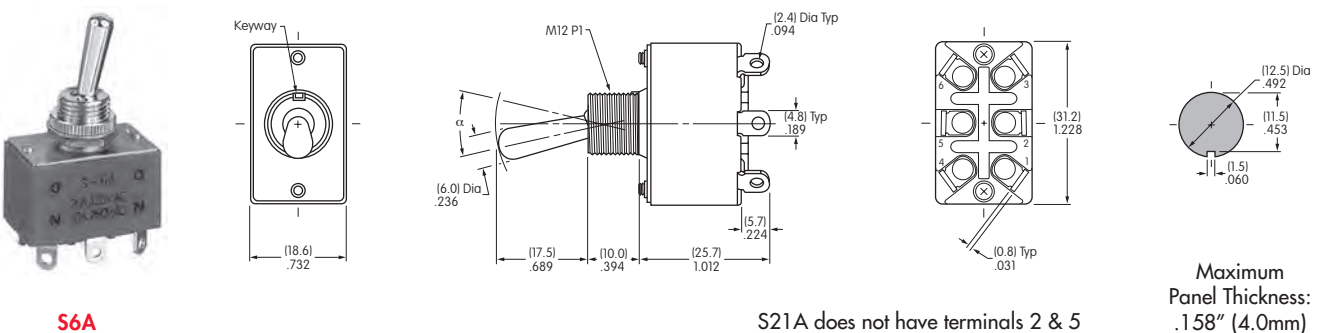

**Notes:** Standard Hardware: AT504M Knurled Nut, AT508 Lockwasher, AT527M Backup Hex Nut. See Accessories & Hardware section.  
Optional Splashproof Boot Assemblies: AT401 & AT4181 boots plus hex nut & o-ring. See Accessories & Hardware section.



Rocker  
Pushbutton  
Illuminated PB  
Programmable  
Keylocks  
Rotaries  
Slides  
Tactiles  
Tilt  
Touch  
Indicators  
Accessories  
Supplement

## SINGLE POLE WITH QUICK CONNECT

Model	Approvals		Pole & Throw	Toggle Position/Connected Terminals				Electrical Capacity				Angle of Throw
	UL	SP		Down 	Center 	Up 	Resistive			Inductive		
							AC 125V	AC 250V	DC 30V	AC 125V PF 0.6		
S1F	—	—	SPST	ON 1-3	NONE	OFF —	15A	6A	20A	8A	25°	
S2F	—	—	SPDT	ON 2-3	NONE	ON 2-1	15A	6A	20A	8A	25°	
S3F	—	—	SPDT	ON 2-3	OFF	ON 2-1	15A	6A	20A	8A	25°	

**Throw & Schematics:** SPST  INTERNAL CONNECTION  Note: Terminal numbers are actually on the switch

**Notes:** Standard Hardware: AT504M Knurled Nut, AT508 Lockwasher, AT527M Backup Hex Nut. See Accessories & Hardware section.  
Optional Splashproof Boot Assemblies: AT401 & AT4181 boots plus hex nut & o-ring. See Accessories & Hardware section.

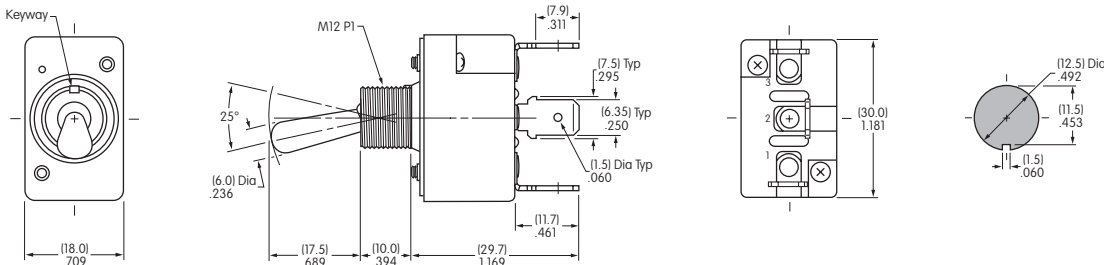





S1F does not have terminal 2

Maximum Panel Thickness: .158" (4.0mm)

**S2F**

## DOUBLE POLE WITH QUICK CONNECT

Model	Approvals		Pole & Throw	Toggle Position/Connected Terminals				Electrical Capacity				$\alpha$ = Angle of Throw
	UL	SP		Down 	Center 	Up 	Resistive			Inductive		
							AC 125V	AC 250V	DC 30V	AC 125V PF 0.6		
S21F	—	—	DPST	ON 1-3 4-6	NONE	OFF —	15A	15A	15A	8A	21°	
S6F	—	—	DPDT	ON 2-3 5-6	NONE	ON 2-1 5-4	20A	10A	20A	8A	21°	
S7F	—	—	DPDT	ON 2-3 5-6	OFF	ON 2-1 5-4	20A	10A	20A	8A	28°	

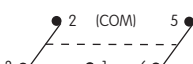
**Throw & Schematics:** DPST  INTERNAL CONNECTION  Note: Terminal numbers are actually on the switch

**Notes:** Standard Hardware: AT504M Knurled Nut, AT508 Lockwasher, AT527M Backup Hex Nut. See Accessories & Hardware section.  
Optional Splashproof Boot Assemblies: AT401 & AT4181 boots plus hex nut & o-ring. See Accessories & Hardware section.

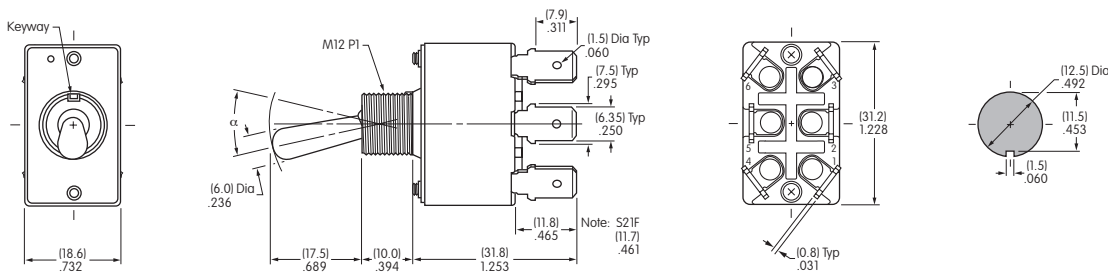

S21F does not have terminals 2 & 5

Maximum Panel Thickness: .158" (4.0mm)

**S6F**

## SINGLE POLE SOLDER LUG WITH PANEL SEAL

Model	Approvals		Pole & Throw	Toggle Position/Connected Terminals ( ) = Momentary				Electrical Capacity			$\alpha$ = Angle of Throw	
	UL	SE		Down	Center	Up	Resistive					
				Keyway			AC 125V	AC 250V	DC 30V			
S1AW	—	—	SPST	ON	1-3	NONE	OFF	—	15A	6A	20A	24°
S2AW	—	—	SPDT	ON	2-3	NONE	ON	2-1	15A	6A	20A	24°
S3AW	—	—	SPDT	ON	2-3	OFF	ON	2-1	15A	6A	20A	28°
S5AW	—	—	SPDT	ON	2-3	NONE	(ON)	2-1	15A	6A	20A	20°
S8AW	—	—	SPDT	(ON)	2-3	OFF	(ON)	2-1	15A	6A	20A	24°
S9AW	—	—	SPDT	ON	2-3	OFF	(ON)	2-1	15A	6A	20A	24°

Throw & Schematics:



Note: Terminal numbers are actually on the switch

Notes: Standard Hardware: AT503M Face Hex Nut, AT508 Lockwasher, AT537 O-ring. See Accessories & Hardware section. For .250" Quick Connect terminals, add "F" to end of part number. See Quick Connect terminal dimensions on previous page. For further information, contact factory.



S2AW

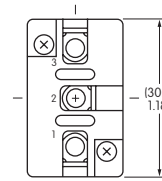
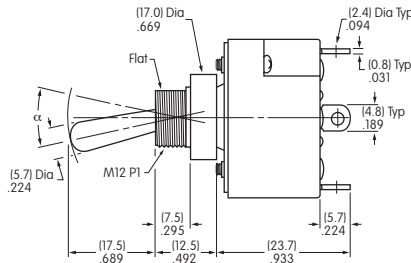
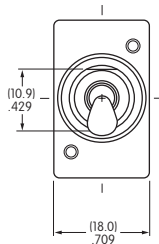

S1AW does not have terminal 2

Maximum Panel Thickness: .158" (4.0mm)

## DOUBLE POLE SOLDER LUG WITH PANEL SEAL

Model	Approvals		Pole & Throw	Toggle Position/Connected Terminals ( ) = Momentary				Electrical Capacity			$\alpha$ = Angle of Throw	
	UL	SE		Down	Center	Up	Resistive					
				Keyway			AC 125V	AC 250V	DC 30V			
S21AW	—	—	DPST	ON	1-3 4-6	NONE	OFF	—	15A	15A	15A	22°
S6AW	—	—	DPDT	ON	2-3 5-6	NONE	ON	2-1 5-4	20A	10A	20A	22°
S7AW	—	—	DPDT	ON	2-3 5-6	OFF	ON	2-1 5-4	20A	10A	20A	28°
S25AW	—	—	DPDT	ON	2-3 5-6	NONE	(ON)	2-1 5-4	15A	6A	20A	20°
S28AW	—	—	DPDT	(ON)	2-3 5-6	OFF	(ON)	2-1 5-4	15A	6A	20A	22°
S29AW	—	—	DPDT	ON	2-3 5-6	OFF	(ON)	2-1 5-4	15A	6A	20A	22°

Throw & Schematics:



Note: Terminal numbers are actually on the switch

Notes: Standard Hardware: AT503M Face Hex Nut, AT508 Lockwasher, AT537 O-ring. See Accessories & Hardware section. For .250" Quick Connect terminals, add "F" to end of part number. See Quick Connect terminal dimensions on previous page. For further information, contact factory.



S6AW

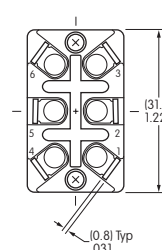
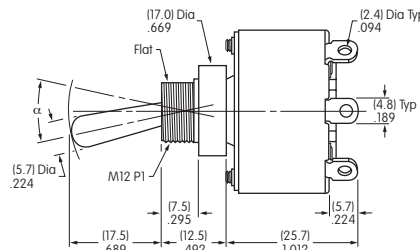
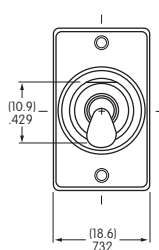

S21AW does not have terminals 2 & 5

Maximum Panel Thickness: .158" (4.0mm)

## SINGLE POLE SOLDER LUG WITH LOCKING LEVER & PANEL SEAL

Model	Approvals 	Pole & Throw	Toggle Position/Connected Terminals				Electrical Capacity				$\alpha$ = Angle of Throw
			Down 	Center 	Up 	Resistive			Inductive		
						AC 125V	AC 250V	DC 30V	AC 125V PF 0.6		
S1AL	—	—	SPST	ON 1-3	NONE	OFF —	15A	6A	20A	8A	24°
S2AL	—	—	SPDT	ON 2-3	NONE	ON 2-1	15A	6A	20A	8A	24°
S3AL	—	—	SPDT	ON 2-3	OFF	ON 2-1	15A	6A	20A	8A	28°

**Throw & Schematics:**

SPST: INTERNAL CONNECTION

SPDT: 2 (COM)

Note: Terminal numbers are actually on the switch

Notes: Standard Hardware: AT503M Face Hex Nut, AT508 Lockwasher, AT537 O-ring. See Accessories & Hardware section.

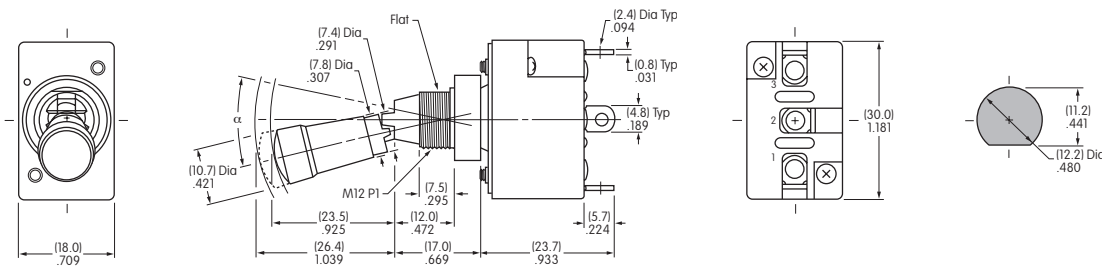

S1AL does not have terminal 2

Maximum Panel Thickness: .158" (4.0mm)

**S2AL**



## DOUBLE POLE SOLDER LUG WITH LOCKING LEVER & PANEL SEAL

Model	* Approvals 	Pole & Throw	Toggle Position/Connected Terminals				Electrical Capacity				$\alpha$ = Angle of Throw
			Down 	Center 	Up 	Resistive			Inductive		
						AC 125V	AC 250V	DC 30V	AC 125V PF 0.6		
S21AL	—	—	DPST	ON 1-3 4-6	NONE	OFF —	15A	15A	15A	8A	22°
S6AL	✓	✓	DPDT	ON 2-3 5-6	NONE	ON 2-1 5-4	20A	10A	20A	8A	22°
S7AL	—	—	DPDT	ON 2-3 5-6	OFF	ON 2-1 5-4	20A	10A	20A	8A	28°

**Throw & Schematics:**

DPST: INTERNAL CONNECTION

DPDT: 2 (COM)

Note: Terminal numbers are actually on the switch

Notes: Standard Hardware: AT503M Face Hex Nut, AT508 Lockwasher, AT537 O-ring. See Accessories & Hardware section.

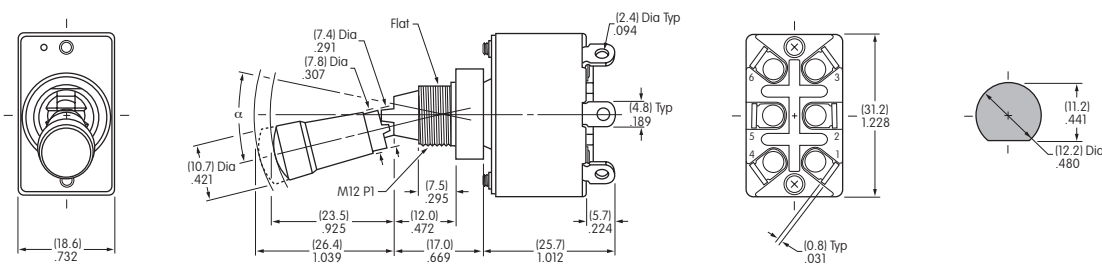

S21AL does not have terminals 2 & 5

Maximum Panel Thickness: .158" (4.0mm)

**S6AL**



### GENERAL SPECIFICATIONS FOR S301 ~ S339

#### Electrical Capacity (Resistive & Inductive Load)

**Power Level:** Shown in the following tables

#### Other Ratings

**Contact Resistance:** 10 milliohms maximum  
**Insulation Resistance:** 1,000 megohms minimum @ 500V DC  
**Dielectric Strength:** 2,000V AC minimum for 1 minute minimum  
**Mechanical Life:** 50,000 operations minimum  
**Electrical Life:** 6,000 operations minimum for S331F; 15,000 operations minimum for all other S331s;  
 25,000 operations minimum for all others  
**Angle of Throw ( $\alpha$ ):** Shown on following tables

#### Materials & Finishes

**Toggle:** PBT for flatted lever; brass with chrome plating for all others  
**Bushing:** Brass with chrome plating  
**Case:** Melamine phenol  
**Case Cover:** Steel with zinc plating  
**Movable Contactor:** Copper with silver plating  
**Movable & Stationary Contacts:** Silver alloy capped on copper with silver plating  
**Terminals:** Brass with tin plating

#### Environmental Data

**Operating Temperature Range:**  $-10^{\circ}\text{C} \sim +70^{\circ}\text{C}$  ( $+14^{\circ}\text{F} \sim +158^{\circ}\text{F}$ )

#### Installation

**Mounting Torque:** 2.94Nm (26 lb•in) for double nut; 1.47Nm (13 lb•in) for single nut  
**Soldering Time & Temperature:** Manual Soldering: See Profile A in Supplement section.



#### Standards & Certifications



**UL:** **File No. E44145 - Recognized only when ordered with marking on switch.**  
 Add "/U" or "/CUL" to end of part number to order UL recognized switch.  
 UL or cULus recognition designated beside part numbers on following pages.  
 See Supplement section to find UL or cULus rating details.

**CSA:** **File No. 023535\_0\_000 - Certified only when ordered with marking on switch.**  
 Add "/C" to end of part number to order CSA certified switch.  
 CSA certification designated beside part numbers on following pages.  
 See Supplement section to find CSA rating details



## SINGLE POLE WITH SOLDER LUG

* UL, cULus & CSA recognized only when ordered with marking on switch (see General Specs)			Toggle Position/Connected Terminals ( ) = Momentary					Electrical Capacity				Angle of Throw
Model	* Approvals			Pole & Throw	Down 	Center 	Up 	Resistive			Inductive	
	UL	cULus	CSA					AC 125V	AC 250V	DC 30V	AC 125V PF 0.6	
S301	✓	✓	✓	SPST	ON 1-3	NONE	OFF —	15A	6A	20A	10A	32°
S302	✓	✓	✓	SPDT	ON 2-3	NONE	ON 2-1	15A	6A	20A	10A	32°
S303	✓	✓	✓	SPDT	ON 2-3	OFF	ON 2-1	15A	6A	20A	10A	32°
S305	—	—	✓	SPDT	ON 2-3	NONE	(ON) 2-1	15A	6A	20A	8A	32°
S308	—	—	✓	SPDT	(ON) 2-3	OFF	(ON) 2-1	15A	6A	20A	8A	32°
S309	—	—	✓	SPDT	ON 2-3	OFF	(ON) 2-1	15A	6A	20A	8A	32°

**Throw & Schematics:** SPST  INTERNAL CONNECTION  Note: Terminal numbers are actually on the switch

**Notes:** Standard Hardware: AT503M Face Hex Nut, AT506M Locking Ring, AT508 Lockwasher, AT527M Backup Hex Nut. See Accessories & Hardware section.  
Optional Splashproof Boot Assemblies: AT401 & AT4181 boots plus hex nut & o-ring. See Accessories & Hardware section.

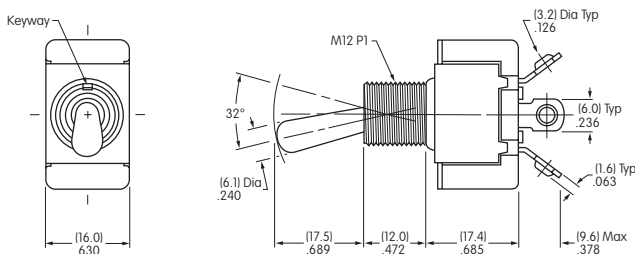



S301 does not have terminal 2



Maximum Panel Thickness: .185" (4.7mm)



S301

## DOUBLE POLE WITH SOLDER LUG

* UL, cULus & CSA recognized only when ordered with marking on switch (see General Specs)			Toggle Position/Connected Terminals ( ) = Momentary					Electrical Capacity				α = Angle of Throw
Model	* Approvals			Pole & Throw	Down 	Center 	Up 	Resistive			Inductive	
	UL	cULus	CSA					AC 125V	AC 250V	DC 30V	AC 125V PF 0.6	
S331	✓	✓	✓	DPST	ON 1-3 4-6	NONE	OFF —	25A	25A	25A	10A	25°
S332	✓	✓	✓	DPDT	ON 2-3 5-6	NONE	ON 2-1 5-4	25A	15A	25A	10A	25°
S333	✓	✓	✓	DPDT	ON 2-3 5-6	OFF	ON 2-1 5-4	25A	15A	25A	10A	30°
S335	✓	✓	✓	DPDT	ON 2-3 5-6	NONE	(ON) 2-1 5-4	15A	6A	20A	8A	25°
S338	✓	✓	—	DPDT	(ON) 2-3 5-6	OFF	(ON) 2-1 5-4	15A	6A	20A	8A	25°
S339	✓	✓	—	DPDT	ON 2-3 5-6	OFF	(ON) 2-1 5-4	15A	6A	20A	8A	25°

**Throw & Schematics:** DPST  INTERNAL CONNECTION  Note: Terminal numbers are actually on the switch

**Notes:** Standard Hardware: AT503M Face Hex Nut, AT506M Locking Ring, AT508 Lockwasher, AT527M Backup Hex Nut. See Accessories & Hardware section.  
Optional Splashproof Boot Assemblies: AT401 & AT4181 boots plus hex nut & o-ring. See Accessories & Hardware section.

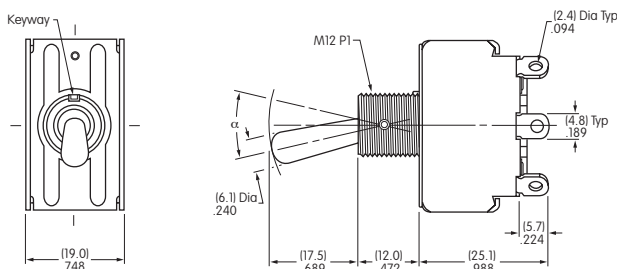

S331 does not have terminals 2 & 5

Maximum Panel Thickness: .185" (4.7mm)





S331

# Series S

## Medium/High Capacity Standard Size Toggles

### DOUBLE POLE WITH SOLDER LUG & FLATTED LEVER

Model	* Approvals			Pole & Throw	Toggle Position/Connected Terminals ( ) = Momentary						Electrical Capacity				$\alpha$ = Angle of Throw
	UL	ULus	SP		Down 	Center 	Up 	Resistive			Inductive				
								AC 125V	AC 250V	DC 30V	AC 125V PF 0.6				
S331R	✓	✓	—	DPST	ON	1-3 4-6	NONE	OFF	—	25A	25A	25A	10A	25°	
S332R	✓	✓	—	DPDT	ON	2-3 5-6	NONE	ON	2-1 5-4	25A	15A	25A	10A	25°	
S333R	✓	✓	—	DPDT	ON	2-3 5-6	OFF	ON	2-1 5-4	25A	15A	25A	10A	30°	
S338R	✓	✓	—	DPDT	(ON)	2-3 5-6	OFF	(ON)	2-1 5-4	15A	6A	20A	8A	25°	
S339R	✓	✓	—	DPDT	ON	2-3 5-6	OFF	(ON)	2-1 5-4	15A	6A	20A	8A	25°	

Throw & Schematics:



Note: Terminal numbers are actually on the switch

Notes: Standard Hardware: AT504M Knurled Nut, AT508 Lockwasher, AT527M Backup Hex Nut. See Accessories & Hardware section.



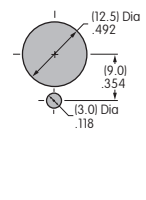
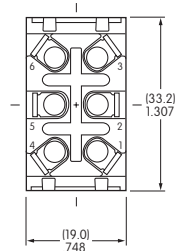
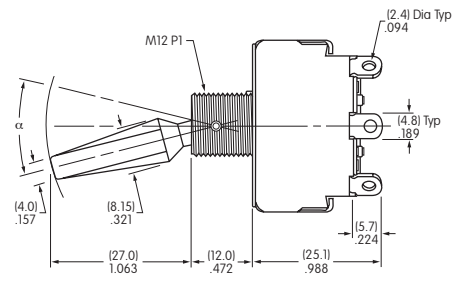
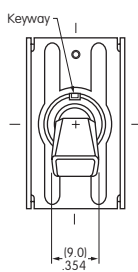

S331R





S331R does not have terminals 2 & 5

Maximum Panel Thickness: .220" (5.6mm)

## SINGLE POLE WITH SCREW LUG



* UL, cULus & CSA recognized only when ordered with marking on switch (see General Specs)			Toggle Position/Connected Terminals ( ) = Momentary					Electrical Capacity				$\alpha =$ Angle of Throw
Model	* Approvals			Pole & Throw	Down 	Center 	Up 	Resistive			Inductive	
	UL	cULus	CSA					AC 125V	AC 250V	DC 30V	AC 125V PF 0.6	
S301T	✓	✓	✓	SPST	ON 1-3	NONE	OFF —	15A	6A	20A	10A	32°
S302T	✓	✓	✓	SPDT	ON 2-3	NONE	ON 2-1	15A	6A	20A	10A	32°
S303T	✓	✓	✓	SPDT	ON 2-3	OFF	ON 2-1	15A	6A	20A	10A	32°
S305T	—	—	✓	SPDT	ON 2-3	NONE	(ON) 2-1	15A	6A	20A	8A	32°
S308T	—	—	✓	SPDT	(ON) 2-3	OFF	(ON) 2-1	15A	6A	20A	8A	32°
S309T	—	—	✓	SPDT	ON 2-3	OFF	(ON) 2-1	15A	6A	20A	8A	32°

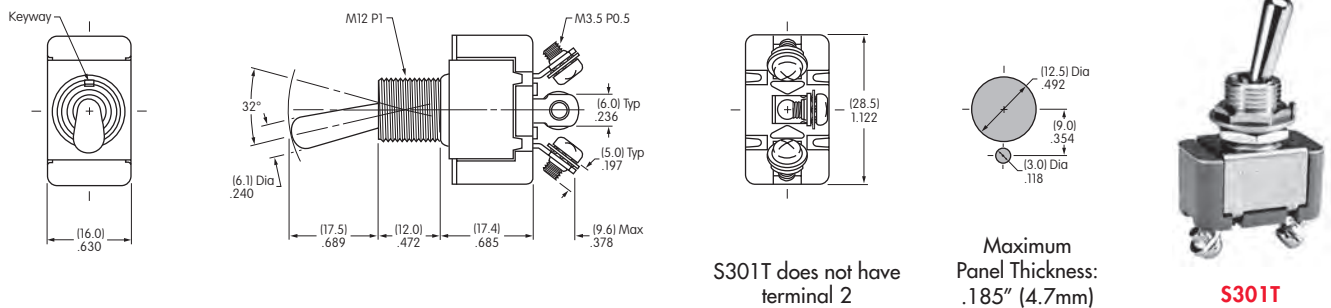

**Throw & Schematics:** SPST  INTERNAL CONNECTION  Note: Terminal numbers are actually on the switch

**Notes:** Standard Hardware: AT503M Face Hex Nut, AT506M Locking Ring, AT508 Lockwasher, AT527M Backup Hex Nut. See Accessories & Hardware section. Optional Splashproof Boot Assemblies: AT401 & AT4181 boots plus hex nut & o-ring. See Accessories & Hardware section.

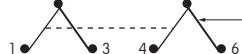

## DOUBLE POLE WITH SCREW LUG

* UL & cULus recognized only when ordered with marking on switch (see General Specs)			Toggle Position/Connected Terminals ( ) = Momentary					Electrical Capacity				$\alpha =$ Angle of Throw
Model	* Approvals			Pole & Throw	Down 	Center 	Up 	Resistive			Inductive	
	UL	cULus	CSA					AC 125V	AC 250V	DC 30V	AC 125V PF 0.6	
S331T	✓	✓	—	DPST	ON 1-3 4-6	NONE	OFF —	15A	15A	15A	10A	25°
S332T	✓	✓	—	DPDT	ON 2-3 5-6	NONE	ON 2-1 5-4	15A	15A	15A	10A	25°
S333T	✓	✓	—	DPDT	ON 2-3 5-6	OFF	ON 2-1 5-4	15A	15A	15A	10A	30°
S335T	✓	✓	—	DPDT	ON 2-3 5-6	NONE	(ON) 2-1 5-4	15A	6A	20A	8A	25°
S338T	✓	✓	—	DPDT	(ON) 2-3 5-6	OFF	(ON) 2-1 5-4	15A	6A	20A	8A	25°
S339T	✓	✓	—	DPDT	ON 2-3 5-6	OFF	(ON) 2-1 5-4	15A	6A	20A	8A	25°

**Throw & Schematics:** DPST  INTERNAL CONNECTION  Note: Terminal numbers are actually on the switch

**Notes:** Standard Hardware: AT503M Face Hex Nut, AT506M Locking Ring, AT508 Lockwasher, AT527M Backup Hex Nut. See Accessories & Hardware section. Optional Splashproof Boot Assemblies: AT401 & AT4181 boots plus hex nut & o-ring. See Accessories & Hardware section.

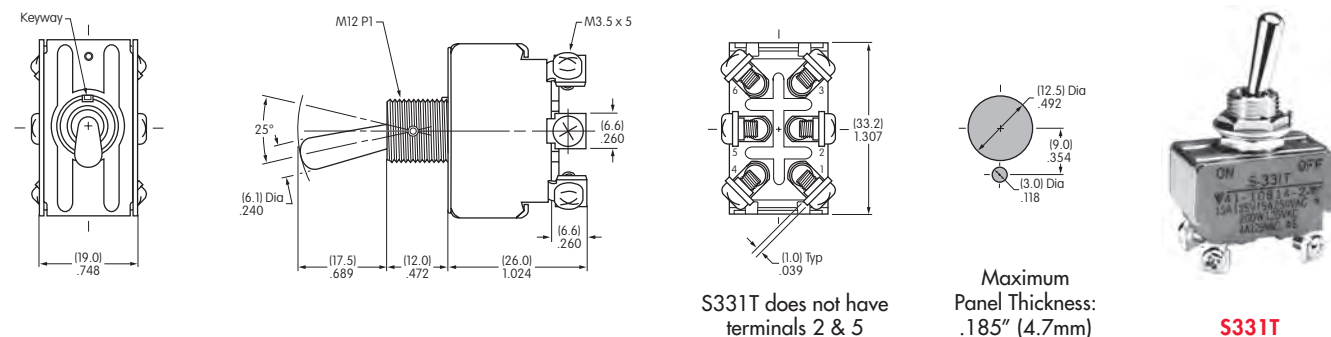

Toggles **A**

Rockers

Pushbuttons

Illuminated PB

Programmable PB

Keylocks

Rotaries

Slides

Tactiles

Tilt



Touch

Indicators

Accessories

Supplement

### SINGLE POLE WITH QUICK CONNECT

* UL, cULus & CSA recognized only when ordered with marking on switch (see General Specs)			Toggle Position/Connected Terminals				Electrical Capacity				$\alpha =$ Angle of Throw	
Model	* Approvals			Pole & Throw	Down 	Center 	Up 	Resistive				Inductive
	UL	cULus	CSA					AC 125V	AC 250V	DC 30V		AC 125V PF 0.6
S301F	✓	✓	✓	SPST	ON 1-3	NONE	OFF —	15A	6A	20A	10A	32°

**Throw & Schematics:** SPST  INTERNAL CONNECTION

Note: Terminal numbers are actually on the switch

**Notes:** Standard Hardware: AT503M Face Hex Nut, AT506M Locking Ring, AT508 Lockwasher, AT527M Backup Hex Nut. See Accessories & Hardware section.  
Optional Splashproof Boot Assemblies: AT401 & AT4181 boots plus hex nut & o-ring. See Accessories & Hardware section.





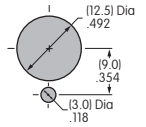
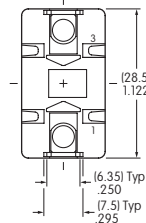
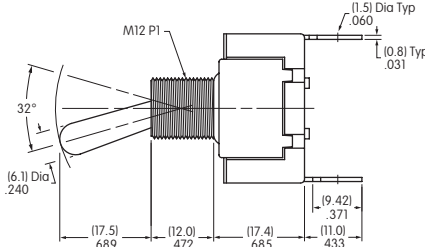
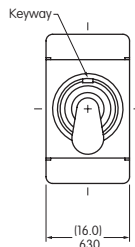

**S301F**



Maximum Panel Thickness: .185" (4.7mm)

### DOUBLE POLE WITH QUICK CONNECT

* UL & cULus recognized only when ordered with marking on switch (see General Specs)			Toggle Position/Connected Terminals ( ) = Momentary				Electrical Capacity				$\alpha =$ Angle of Throw	
Model	* Approvals			Pole & Throw	Down 	Center 	Up 	Resistive				Inductive
	UL	cULus	CSA					AC 125V	AC 250V	DC 30V		AC 125V PF 0.6
S331F	✓	✓	—	DPST	ON 1-3 4-6	NONE	OFF —	25A	25A	25A	10A	25°
S332F	✓	✓	—	DPDT	ON 2-3 5-6	NONE	ON 2-1 5-4	25A	15A	25A	10A	25°
S333F	✓	✓	—	DPDT	ON 2-3 5-6	OFF	ON 2-1 5-4	25A	15A	25A	10A	30°
S335F	✓	✓	—	DPDT	ON 2-3 5-6	NONE	(ON) 2-1 5-4	15A	6A	20A	8A	25°

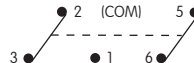
**Throw & Schematics:** DPST  INTERNAL CONNECTION DPDT 

Note: Terminal numbers are actually on the switch

**Notes:** Standard Hardware: AT503M Face Hex Nut, AT506M Locking Ring, AT508 Lockwasher, AT527M Backup Hex Nut. See Accessories & Hardware section.  
Optional Splashproof Boot Assemblies: AT401 & AT4181 boots plus hex nut & o-ring. See Accessories & Hardware section.



**S332F**

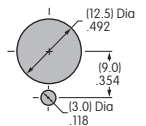
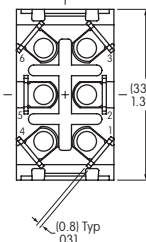
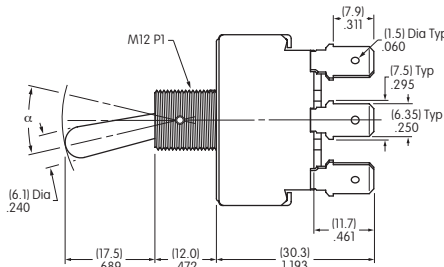
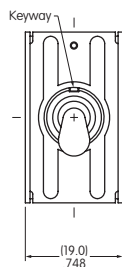

Maximum Panel Thickness: .185" (4.7mm)

S331F does not have terminals 2 & 5

## GENERAL SPECIFICATIONS FOR S31 ~ S49

### Electrical Capacity (Resistive & Inductive Load)

**Power Level:** Shown in the following tables

### Other Ratings

- Contact Resistance:** 10 milliohms maximum
- Insulation Resistance:** 1,000 megohms minimum @ 500V DC
- Dielectric Strength:** 2,000V AC minimum for 1 minute minimum
- Mechanical Life:** 50,000 operations minimum
- Electrical Life:** 25,000 operations minimum
- Angle of Throw ( $\alpha$ ):** Shown on following tables

### Materials & Finishes

- Toggle:** PBT resin for flatted lever; brass with chrome plating for all others
- Bushing:** Brass with chrome plating
- Case:** Phenolic resin
- Case Cover:** Steel with chromate plating over zinc plating
- Movable Contactor:** Copper with silver plating
- Movable Contacts:** Silver alloy capped on copper with silver plating
- Stationary Contacts:** Silver alloy capped on copper with silver plating
- Terminals:** Brass with tin plating

### Environmental Data

**Operating Temp Range:** -10°C through +70°C (+14°F through +158°F)

### Installation

- Mounting Torque:** 2.94Nm (26 lb•in) for double nut
- Maximum Panel Thickness:** Shown beneath panel cutout in switch dimension drawings
- Soldering Time & Temperature:** Manual Soldering: See Profile A in Supplement section.

### Standards & Certifications

- UL:** **File No. E44145 - Recognized only when ordered with marking on switch.**  
Add "/U" or "/CUL" to end of part number to order UL recognized switch.  
UL or cULus recognition designated beside part numbers on following pages.  
See Supplement section to find UL or cULus rating details.
- CSA:** **File No. 023535\_0\_000 - Certified only when ordered with marking on switch.**  
Add "/C" to end of part number to order CSA certified switch.  
CSA certification designated beside part numbers on following pages.  
See Supplement section to find CSA rating details.

A  
Toggles

Rockers

Pushbuttons

Illuminated PB

Programmable

Keylocks

Rotaries

Slides

Tactiles

Tilt

Touch

Indicators

Accessories

Supplement

Toggles **A**

### THREE POLE WITH SOLDER LUG

* UL, cULus & CSA recognized only when ordered with marking on switch (see General Specs)				Toggle Position/Connected Terminals ( ) = Momentary						Electrical Capacity				
Model	* Approvals			Pole & Throw	Down Keyway	Center	Up	Resistive			Inductive AC 125V PF 0.6	$\alpha$ = Angle of Throw		
	UL	cULus	CSA					AC 125V	AC 250V	DC 30V				
S31	✓	✓	✓	3PST	ON	1-3 4-6 7-9	NONE	OFF	—	25A	9A	20A	10A	25°
S32	✓	✓	✓	3PDT	ON	2-3 5-6 8-9	NONE	ON	2-1 5-4 8-7	25A	9A	20A	10A	25°
S33	✓	✓	✓	3PDT	ON	2-3 5-6 8-9	OFF	ON	2-1 5-4 8-7	25A	9A	20A	10A	30°
S35	✓	✓	✓	3PDT	ON	2-3 5-6 8-9	NONE	(ON)	2-1 5-4 8-7	15A	6A	20A	8A	25°
S38	✓	✓	✓	3PDT	(ON)	2-3 5-6 8-9	OFF	(ON)	2-1 5-4 8-7	15A	6A	15A	8A	25°
S39	✓	✓	✓	3PDT	ON	2-3 5-6 8-9	OFF	(ON)	2-1 5-4 8-7	15A	6A	15A	8A	25°



**Notes:** Standard Hardware: AT503M Face Hex Nut, AT506M Locking Ring, AT508 Lockwasher, AT527M Backup Hex Nut. See Accessories & Hardware section.  
Optional Splashproof Boot Assemblies: AT401 & AT4181 boots plus hex nut & o-ring. See Accessories & Hardware section.

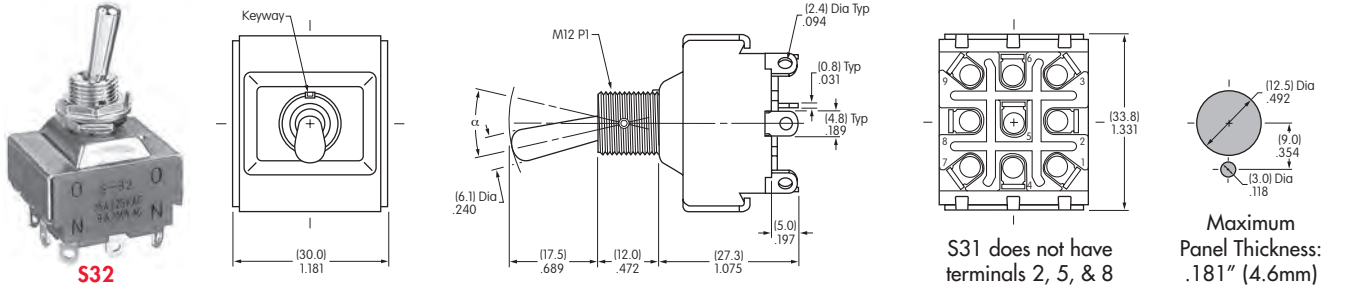

### FOUR POLE WITH SOLDER LUG

* UL, cULus & CSA recognized only when ordered with marking on switch (see General Specs)				Toggle Position/Connected Terminals ( ) = Momentary						Electrical Capacity				
Model Suffix R = Flatted Lever	* Approvals			Pole & Throw	Down Keyway	Center	Up	Resistive			Inductive AC 125V PF 0.6	$\alpha$ = Angle of Throw		
	UL	cULus	CSA					AC 125V	AC 250V	DC 30V				
S41/S41R	✓	✓	✓	4PST	ON	1-3 4-6 7-9 10-12	NONE	OFF	—	25A	9A	20A	10A	25°
S42/S42R	✓	✓	✓	4PDT	ON	2-3 5-6 8-9 11-12	NONE	ON	2-1 5-4 8-7 11-10	25A	9A	20A	10A	25°
S43/S43R	✓	✓	✓	4PDT	ON	2-3 5-6 8-9 11-12	OFF	ON	2-1 5-4 8-7 11-10	25A	9A	20A	10A	30°
S45	—	✓	—	4PDT	ON	2-3 5-6 8-9 11-12	NONE	(ON)	2-1 5-4 8-7 11-10	15A	6A	20A	8A	25°
S48/S48R	✓	✓	—	4PDT	(ON)	2-3 5-6 8-9 11-12	OFF	(ON)	2-1 5-4 8-7 11-10	15A	6A	20A	8A	25°
S49/S49R	✓	✓	—	4PDT	ON	2-3 5-6 8-9 11-12	OFF	(ON)	2-1 5-4 8-7 11-10	15A	6A	20A	8A	25°



**Notes:** Standard Hardware for **Bat Lever:** AT503M Face Hex Nut, AT506M Locking Ring, AT508 Lockwasher, AT527M Backup Hex Nut; for **Flatted Lever (R):** AT504M Knurled Face Nut, AT508 Lockwasher, AT527M Backup Hex Nut. See Accessories & Hardware section.  
Optional Splashproof Boot Assemblies (only for bat lever models): AT401 & AT4181 boots plus hex nut and o-ring. See Accessories & Hardware section.

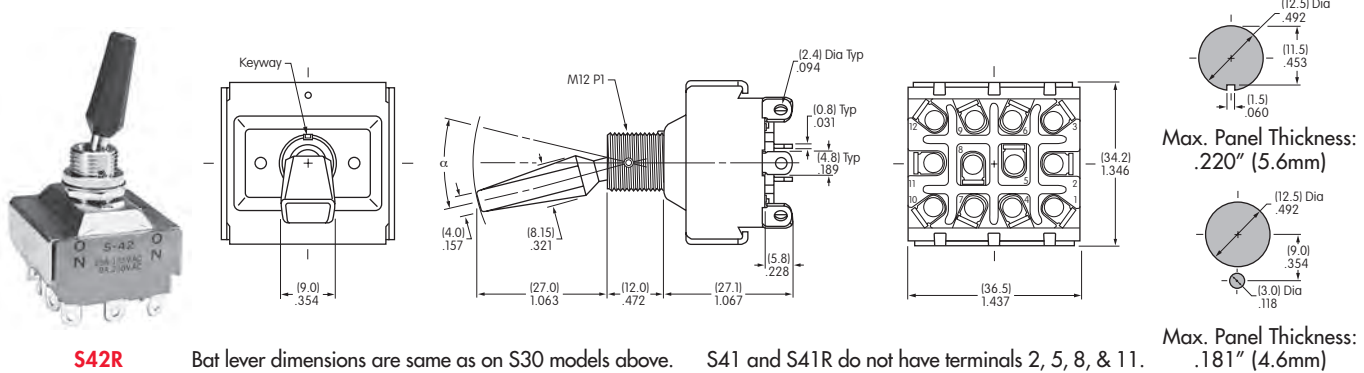

**S42R** Bat lever dimensions are same as on S30 models above. S41 and S41R do not have terminals 2, 5, 8, & 11. Max. Panel Thickness: .181" (4.6mm)

Toggles  
Rocker  
Pushbuttons  
Illuminated PB  
Programmable  
Keylocks  
Rotaries  
Slides  
Tactiles  
Tilt  
Touch  
Indicators  
Accessories  
Supplement

## THREE POLE WITH SCREW LUG

* UL, cULus & CSA recognized only when ordered with marking on switch (see General Specs)			Toggle Position/Connected Terminals						Electrical Capacity						
Model	* Approvals			Pole & Throw	Down	Center	Up	Resistive			Inductive		$\alpha$ = Angle of Throw		
	UL	cULus	CSA		Keyway			AC 125V	AC 250V	DC 30V	AC 125V PF 0.6	AC 250V PF 0.6			
S31T	✓	✓	✓	3PST	ON	1-3 4-6 7-9	NONE	OFF	—	25A	9A	20A	10A	5A	25°
S32T	✓	✓	✓	3PDT	ON	2-3 5-6 8-9	NONE	ON	2-1 5-4 8-7	25A	9A	20A	10A	5A	25°
S33T	✓	✓	✓	3PDT	ON	2-3 5-6 8-9	OFF	ON	2-1 5-4 8-7	25A	9A	20A	10A	5A	30°

**Throw & Schematics:**

3PST:

3PDT:

Note: Terminal numbers are on the switch

**Notes:** Standard Hardware: AT503M Face Hex Nut, AT506M Locking Ring, AT508 Lockwasher, AT527M Backup Hex Nut. See Accessories & Hardware section. Optional Splashproof Boot Assemblies: AT401 & AT4181 boots plus hex nut & o-ring. See Accessories & Hardware section.

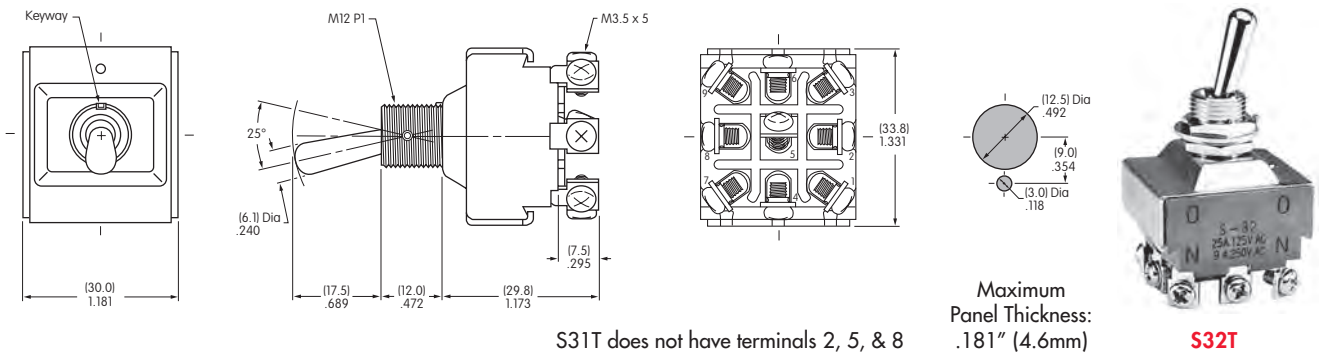

## FOUR POLE WITH SCREW LUG

* UL, cULus & CSA recognized only when ordered with marking on switch (see General Specs)			Toggle Position/Connected Terminals						Electrical Capacity						
Model	* Approvals			Pole & Throw	Down	Center	Up	Resistive			Inductive		$\alpha$ = Angle of Throw		
	UL	cULus	CSA		Keyway			AC 125V	AC 250V	DC 30V	AC 125V PF 0.6	AC 250V PF 0.6			
S41T	✓	✓	✓	4PST	ON	1-3 4-6 7-9 10-12	NONE	OFF	—	25A	9A	20A	10A	5A	25°
S42T	✓	✓	✓	4PDT	ON	2-3 5-6 8-9 11-12	NONE	ON	2-1 5-4 8-7 11-10	25A	9A	20A	10A	5A	25°
S43T	✓	✓	✓	4PDT	ON	2-3 5-6 8-9 11-12	OFF	ON	2-1 5-4 8-7 11-10	25A	9A	20A	10A	5A	30°

**Throw & Schematics:**

4PST:

4PDT:

Note: Terminal numbers are on the switch

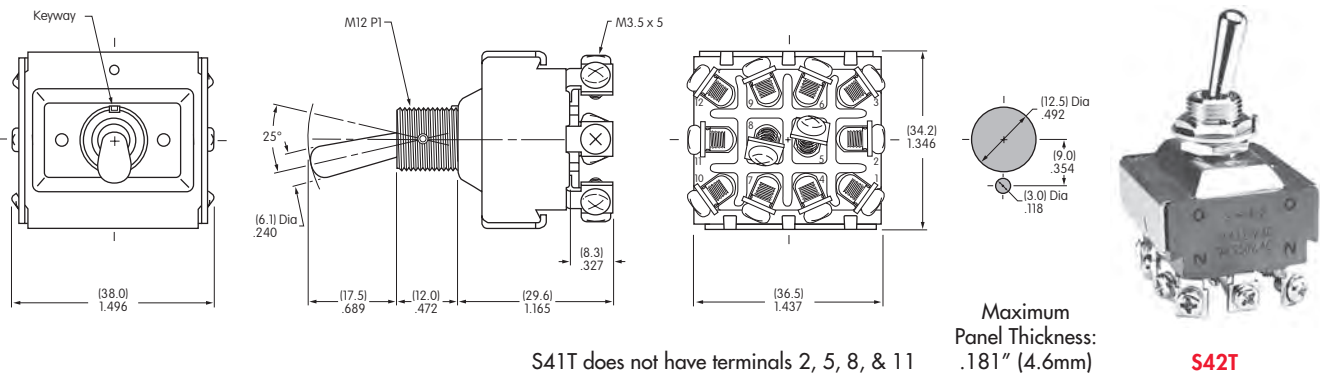

**Notes:** Standard Hardware: AT503M Face Hex Nut, AT506M Locking Ring, AT508 Lockwasher, AT527M Backup Hex Nut. See Accessories & Hardware section. Optional Splashproof Boot Assemblies: AT401 & AT4181 boots plus hex nut & o-ring. See Accessories & Hardware section.



Toggles  
A

### THREE POLE WITH QUICK CONNECT

\* UL, cULus & CSA recognized only when ordered with marking on switch (see General Specs)

Model	* Approvals			Pole & Throw	Toggle Position/Connected Terminals			Electrical Capacity				$\alpha =$ Angle of Throw
	UL	cULus	CSA		Down 	Center 	Up 	Resistive			Inductive	
								AC 125V	AC 250V	DC 30V	AC 125V PF 0.6	
S31F	✓	✓	✓	3PST	ON 1-3 4-6 7-9	NONE	OFF —	25A	9A	20A	10A	25°
S32F	✓	✓	✓	3PDT	ON 2-3 5-6 8-9	NONE	ON 2-1 5-4 8-7	25A	9A	20A	10A	25°
S33F	✓	✓	✓	3PDT	ON 2-3 5-6 8-9	OFF	ON 2-1 5-4 8-7	25A	9A	20A	10A	30°

**Throw & Schematics:**

3PST  INTERNAL CONNECTION

3PDT  (COM) 8

Note: Terminal numbers are on the switch

**Notes:** Standard Hardware: AT503M Face Hex Nut, AT506M Locking Ring, AT508 Lockwasher, AT527M Backup Hex Nut. See Accessories & Hardware section.  
Optional Splashproof Boot Assemblies: AT401 & AT4181 boots plus hex nut & o-ring. See Accessories & Hardware section.



**S32F**

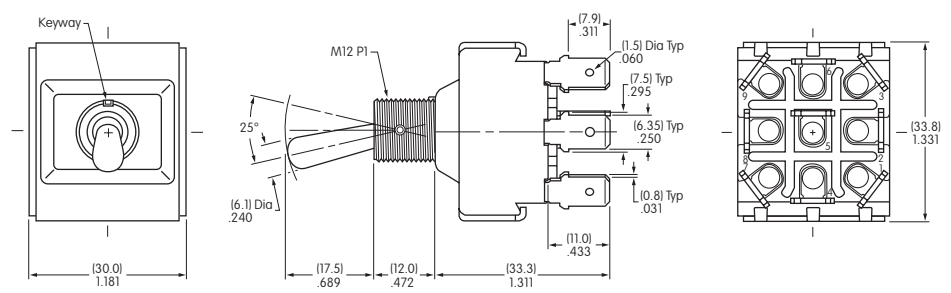

Keyway

M12 P1

25°

(6.1) Dia .240

(17.5) .689

(12.0) .472

(7.9) .311

(1.5) Dia Typ .060

(7.5) Typ .295

(6.35) Typ .250

(11.0) .433

(0.8) Typ .031

(33.8) 1.331

(12.5) Dia .492

(9.0) .354



(3.0) Dia .118

Maximum Panel Thickness: .181" (4.6mm)

S31F does not have terminals 2, 5, & 8

### FOUR POLE WITH QUICK CONNECT

\* UL, cULus & CSA recognized only when ordered with marking on switch (see General Specs)

Model	* Approvals			Pole & Throw	Toggle Position/Connected Terminals			Electrical Capacity				$\alpha =$ Angle of Throw
	UL	cULus	CSA		Down 	Center 	Up 	Resistive			Inductive	
								AC 125V	AC 250V	DC 30V	AC 125V PF 0.6	
S41F	✓	✓	✓	4PST	ON 1-3 4-6 7-9 10-12	NONE	OFF —	25A	9A	20A	10A	25°
S42F	✓	✓	✓	4PDT	ON 2-3 5-6 8-9 11-12	NONE	ON 2-1 5-4 8-7 11-10	25A	9A	20A	10A	25°
S43F	✓	✓	✓	4PDT	ON 2-3 5-6 8-9 11-12	OFF	ON 2-1 5-4 8-7 11-10	25A	9A	20A	10A	30°

**Throw & Schematics:**

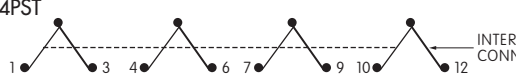
4PST  INTERNAL CONNECTION

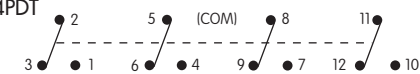
4PDT  (COM) 8

Note: Terminal numbers are on the switch

**Notes:** Standard Hardware: AT503M Face Hex Nut, AT506M Locking Ring, AT508 Lockwasher, AT527M Backup Hex Nut. See Accessories & Hardware section.  
Optional Splashproof Boot Assemblies: AT401 & AT4181 boots plus hex nut & o-ring. See Accessories & Hardware section.



**S42F**

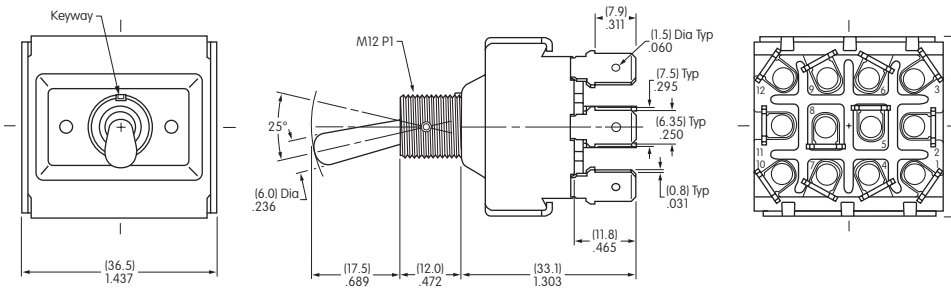

Keyway

M12 P1

25°

(6.0) Dia .236

(17.5) .689

(12.0) .472

(7.9) .311

(1.5) Dia Typ .060

(7.5) Typ .295

(6.35) Typ .250

(11.8) .465

(0.8) Typ .031

(34.2) 1.346

(12.5) Dia .492

(9.0) .354

(3.0) Dia .118

Maximum Panel Thickness: .181" (4.6mm)

S41F does not have terminals 2, 5, 8, & 11

Rockers

Pushbuttons

Illuminated PB

Programmable

Keylocks

Rotaries

Slides

Tactiles

Tilt

Touch

Indicators

Accessories

Supplement



GENERAL SPECIFICATIONS FOR S421 ~ S429

**Electrical Capacity (Resistive & Inductive Load)**

**Power Level:** Shown in the following tables

**Other Ratings**

- Contact Resistance:** 10 milliohms maximum
- Insulation Resistance:** 1,000 megohms minimum @ 500V DC
- Dielectric Strength:** 2,000V AC minimum for 1 minute minimum
- Mechanical Life:** 50,000 operations minimum
- Electrical Life:** 15,000 operations minimum
- Angle of Throw ( $\alpha$ ):** Shown in tables on following pages

**Materials & Finishes**

- Toggle:** Brass with chrome plating
- Bushing:** Brass with chrome plating
- Case:** Melamine phenol
- Case Cover:** Steel with chromate plating over zinc plating
- Movable Contactor:** Copper with silver plating
- Movable Contacts:** Silver alloy capped on copper with silver plating
- Stationary Contacts:** Silver alloy capped on copper with silver plating
- Terminals:** Brass with tin plating

**Environmental Data**

**Operating Temp Range:** -10°C through +70°C (+14°F through +158°F)

**Installation**

- Mounting Torque:** 2.94Nm (26 lb·in) for double nut
- Maximum Panel Thickness:** Shown beneath panel cutout in switch dimension drawings
- Soldering Time & Temperature:** Manual Soldering: See Profile A in Supplement section.

A Toggles

Rockers

Pushbuttons

Illuminated PB

Programmable

Keylocks

Rotaries

Slides

Tactiles

Tilt

Touch

Indicators

Accessories

Supplement

Toggles A

Rockers

Pushbuttons

Illuminated PB

Programmable

Keylocks

Rotaries

Slides

Tactiles

Tilt



Touch

Indicators

Accessories

Supplement

## DOUBLE POLE WITH SOLDER LUG

Model	Approvals		Pole & Throw	Toggle Position/Connected Terminals ( ) = Momentary			Electrical Capacity				Motor Load AC 125V	α = Angle of Throw
	UL	CSA		Down 	Center 	Up 	Resistive		Inductive			
							AC 125V	AC 250V	PF 0.75 - 0.8			
S421	—	—	DPST	ON 1-3 4-6	NONE	OFF —	25A	25A	25A	25A	750W	24°
S422	—	—	DPDT	ON 2-3 5-6	NONE	ON 2-1 5-4	25A	25A	25A	25A	750W	24°
S423	—	—	DPDT	ON 2-3 5-6	OFF	ON 2-1 5-4	25A	25A	25A	25A	750W	28°
S425	—	—	DPDT	ON 2-3 5-6	NONE	(ON) 2-1 5-4	15A	15A	15A	15A	400W	24°
S428	—	—	DPDT	(ON) 2-3 5-6	OFF	(ON) 2-1 5-4	15A	15A	15A	15A	400W	24°
S429	—	—	DPDT	ON 2-3 5-6	OFF	(ON) 2-1 5-4	15A	15A	15A	15A	400W	24°

Throw & Schematics:



Note: Terminal numbers are on the switch

**Notes:** Standard Hardware: AT503M Face Hex Nut, AT506M Locking Ring, AT508 Lockwasher, AT527M Backup Hex Nut. See Accessories & Hardware section. Optional Splashproof Boot Assemblies: AT401 & AT4181 boots plus hex nut & o-ring. See Accessories & Hardware section.



S422

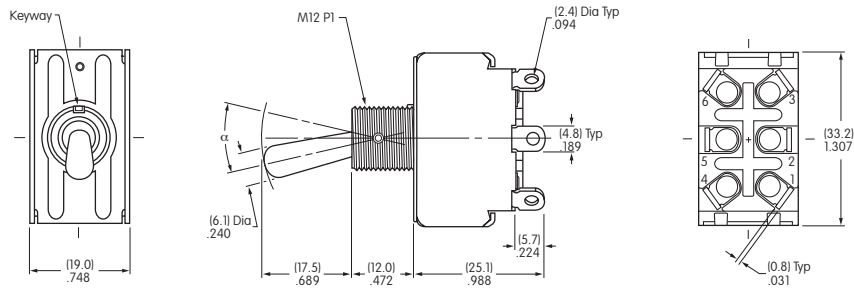

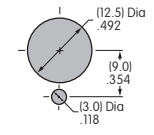

S421 does not have terminals 2 & 5



Maximum Panel Thickness: .185" (4.7mm)

## DOUBLE POLE WITH SCREW LUG

Model	Approvals		Pole & Throw	Toggle Position/Connected Terminals ( ) = Momentary			Electrical Capacity				Motor Load AC 125V	α = Angle of Throw
	UL	CSA		Down 	Center 	Up 	Resistive		Inductive			
							AC 125V	AC 250V	PF 0.75 - 0.8			
S421T	—	—	DPST	ON 1-3 4-6	NONE	OFF —	20A	20A	20A	20A	750W	24°
S422T	—	—	DPDT	ON 2-3 5-6	NONE	ON 2-1 5-4	20A	20A	20A	20A	750W	24°
S423T	—	—	DPDT	ON 2-3 5-6	OFF	ON 2-1 5-4	20A	20A	20A	20A	750W	28°
S425T	—	—	DPDT	ON 2-3 5-6	NONE	(ON) 2-1 5-4	15A	15A	15A	15A	400W	24°
S428T	—	—	DPDT	(ON) 2-3 5-6	OFF	(ON) 2-1 5-4	15A	15A	15A	15A	400W	24°
S429T	—	—	DPDT	ON 2-3 5-6	OFF	(ON) 2-1 5-4	15A	15A	15A	15A	400W	24°

Throw & Schematics:



Note: Terminal numbers are on the switch

**Notes:** Standard Hardware: AT503M Face Hex Nut, AT506M Locking Ring, AT508 Lockwasher, AT527M Backup Hex Nut. See Accessories & Hardware section. Optional Splashproof Boot Assemblies: AT401 & AT4181 boots plus hex nut & o-ring. See Accessories & Hardware section.



S423T

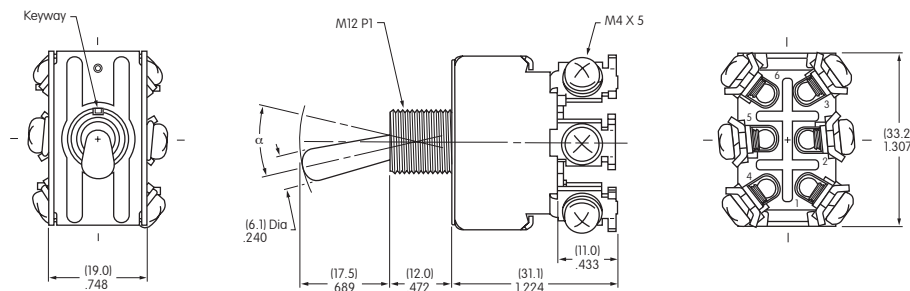

S421T does not have terminals 2 & 5

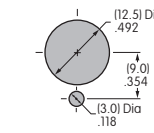

Maximum Panel Thickness: .185" (4.7mm)

## GENERAL SPECIFICATIONS FOR S800s ~ S732

A  
Toggles

### Electrical Capacity (Resistive & Inductive Load)

**Power Level:** Shown in the following tables

Rockers

### Other Ratings

**Contact Resistance:** 10 milliohms maximum

**Insulation Resistance:** 1,000 megohms minimum @ 500V DC

**Dielectric Strength:** 2,000V AC minimum for 1 minute minimum for S800s & S800Ds  
3,000V AC minimum for 1 minute minimum for S732

**Mechanical Life:** 50,000 operations minimum

**Electrical Life:** 10,000 operations minimum for S800Ds  
25,000 operations minimum for S800s & S732

Pushbuttons

Illuminated PB

Programmable

### Materials & Finishes

**Toggle:** Brass with nickel plating for S732  
Brass with chrome plating for S800s & S800Ds

**Bushing:** Brass with chrome plating

**Case:** Phenolic resin for S732; melamine phenol for S800s

**Case Cover:** Steel with chromate plating over zinc plating

**Movable Contactor Plate:** Copper with silver plating

**Movable & Stationary Contacts:** Silver alloy capped on copper with silver plating

**Common Terminals:** Brass

**Contact Terminals:** Brass with silver or nickel plating

Key locks

Rotaries

Slides

### Environmental Data

**Operating Temp Range:** -10°C through +70°C (+14°F through +158°F)

Tactiles

### Installation

**Mounting Torque:** 2.94Nm (26 lb•in) for double nut

**Maximum Panel Thickness:** Shown beneath panel cutout in switch dimension drawings

Tilt

### Standards & Certifications

**UL:** **File No. E44145 - Recognized only when ordered with marking on switch.**  
Add "/U" or "/CUL" to end of part number to order UL recognized switch.  
UL or cULus recognition designated beside part numbers on following pages.  
See Supplement section to find UL or cULus rating details.

**CSA:** **File No. 023535\_0\_000 - Certified only when ordered with marking on switch.**  
Add "/C" to end of part number to order CSA certified switch.  
CSA certification designated beside part numbers on following pages.  
See Supplement section to find CSA rating details.

Touch

Indicators

Accessories

Supplement

Toggles  
 Rockers  
 Pushbuttons  
 Illuminated PB  
 Programmable  
 Keylocks  
 Rotarys  
 Slides  
 Tactiles  
 Tilt  
 Touch  
 Indicators  
 Accessories  
 Supplement

## DOUBLE POLE WITH SCREW LUG

* UL, cULus & CSA recognized only when ordered with marking on switch (see General Specs)				Toggle Position/Connected Terminals			Electrical Capacity							
Model	* Approvals			Pole & Throw	Down	Center	Up	Resistive			Inductive		Motor Load	
	UL	cULus	CSA		Keyway			AC 125V	AC 250V	DC 30V	DC 125V	AC 125V PF 0.6	AC 250V PF 0.6	AC 125V
S821	✓	✓	✓	DPST	ON 2-3 5-6	NONE	OFF —	30A	30A	30A	1A	30A	15A	750W
S822	✓	✓	✓	DPDT	ON 2-3 5-6	NONE	ON 2-1 5-4	30A	30A	30A	1A	30A	15A	—
S823	✓	✓	✓	DPDT	ON 2-3 5-6	OFF	ON 2-1 5-4	30A	30A	30A	1A	30A	15A	—



**Notes:** Standard Hardware: AT503M Face Hex Nut, AT506M Locking Ring, AT508 Lockwasher, AT527M Backup Hex Nut. See Accessories & Hardware section.  
 Optional Splashproof Boot Assembly: AT401 boot plus hex nut & o-ring. See Accessories & Hardware section.

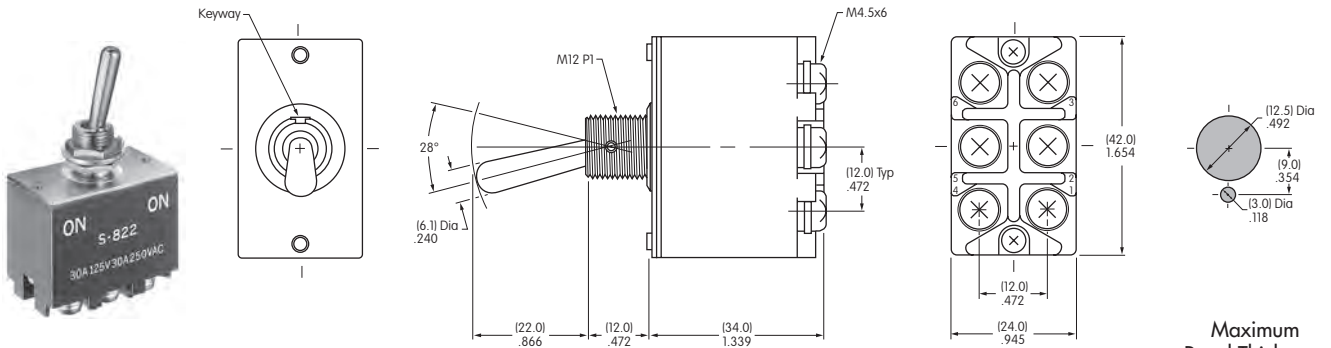

**S822**

S821 does not have terminals 1 & 4

Maximum Panel Thickness: .177" (4.5mm)

## THREE POLE WITH SCREW LUG

* UL, cULus & CSA recognized only when ordered with marking on switch (see General Specs)				Toggle Position/Connected Terminals			Electrical Capacity						
Model	* Approvals			Pole & Throw	Down	Center	Up	Resistive			Inductive		
	UL	cULus	CSA		Keyway			AC 125V	AC 250V	DC 30V	DC 125V	AC 125V PF 0.6	AC 250V PF 0.6
S831	✓	✓	✓	3PST	ON 2-3 5-6 8-9	NONE	OFF —	30A	30A	30A	1A	30A	15A
S832	✓	✓	✓	3PDT	ON 2-3 5-6 8-9	NONE	ON 2-1 5-4 8-7	30A	30A	30A	1A	30A	15A
S833	✓	✓	✓	3PDT	ON 2-3 5-6 8-9	OFF	ON 2-1 5-4 8-7	30A	30A	30A	1A	30A	15A



**Notes:** Standard Hardware: AT503M Face Hex Nut, AT506M Locking Ring, AT508 Lockwasher, AT527M Backup Hex Nut. See Accessories & Hardware section.  
 Optional Splashproof Boot Assembly: AT401 boot plus hex nut & o-ring. See Accessories & Hardware section.

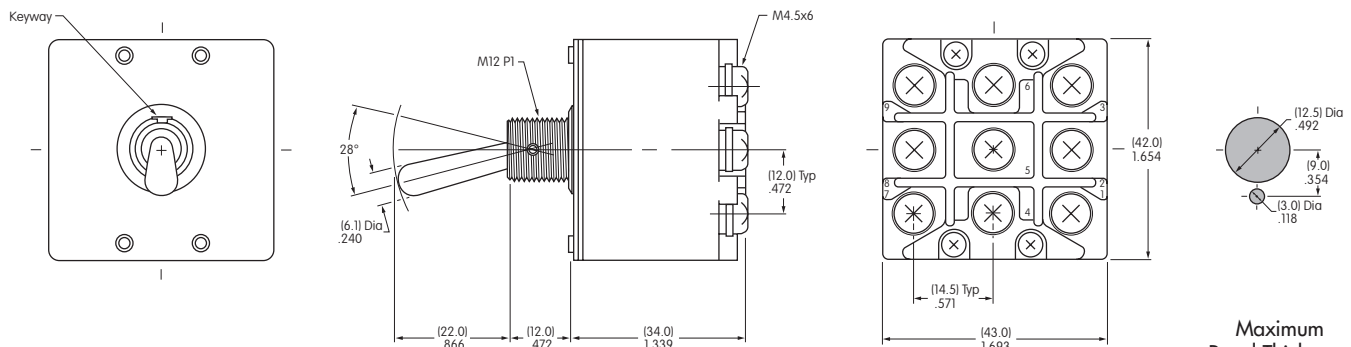

**S833**

S831 does not have terminals 1, 4 & 7

Maximum Panel Thickness: .177" (4.5mm)

## DOUBLE POLE WITH SCREW LUG & FLATTED LEVER

* UL, cULus & CSA recognized only when ordered with marking on switch (see General Specs)			Toggle Position/Connected Terminals				Electrical Capacity										
Model	* Approvals	Pole & Throw	Down		Center	Up		Resistive					Inductive L/R = 3ms				
			Keyway	2-3	5-6	NONE	OFF	—	DC 30V	DC 48V	DC 125V	DC 250V	DC 400V	DC 24V	DC 48V	DC 125V	DC 250V
S821D	✓ ✓ ✓	DPST	ON	2-3	5-6	NONE	OFF	—	30A	30A	20A	15A	4A (10A)	15A	10A	6A	3A
S822D	✓ ✓ ✓	DPDT	ON	2-3	5-6	NONE	ON	2-1 5-4	30A	30A	20A	15A	4A	15A	10A	6A	3A
S823D	✓ ✓ ✓	DPDT	ON	2-3	5-6	OFF	ON	2-1 5-4	30A	30A	15A	7.5A	—	15A	10A	6A	3A

( ) capacity is due to wiring. Refer to instructions below.



**Notes:** Standard Hardware: AT503M Face Hex Nut, AT506M Locking Ring, AT508 Lockwasher, AT527M Backup Hex Nut. See Accessories & Hardware section.

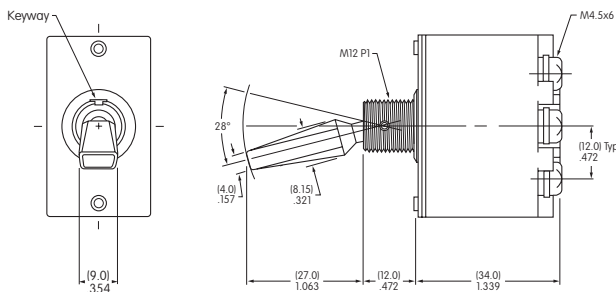

### Double Pole

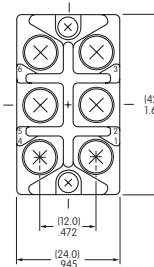

S821D does not have terminals 1 & 4

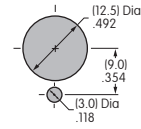

Maximum Panel Thickness: .177" (4.5mm)



**S822D**

## 400V DC WIRING INSTRUCTIONS

### 1. DC Switch Use

- Middle terminal shall be the minus pole when using DC circuit. Switch case is marked with (+) and (-).
- Do not store near (5cm) highly magnetic items.
- If actuation is interrupted when switching from ON to OFF, arcing may continue and switch could be burned.

### 2. Wiring for DC400V 10A

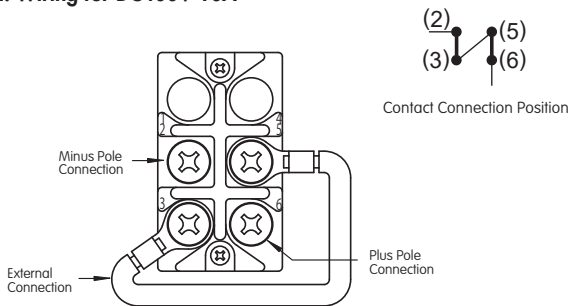

### 3. Inductive Load

Inductive loads produce an arc caused by counter-electromotive force when opening the circuit. Recommend inserting spark elimination circuit. Contact factory for details.

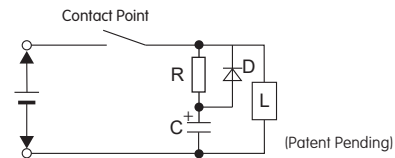

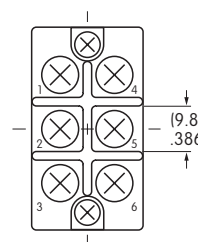

### 4. Compressed Terminal Connection

When connecting screw terminal with compressed terminal, select compressed terminal using drawing below.



## THREE POLE WITH SCREW LUG & FLATTED LEVER

\* UL, cULus & CSA recognized only when ordered with marking on switch (see General Specs)

Model	* Approvals			Pole & Throw	Toggle Position/Connected Terminals			Electrical Capacity							
	UL	cULus	CSA		Down 	Center 	Up 	Resistive				Inductive L/R = 3ms			
								DC 30V	DC 48V	DC 125V	DC 250V	DC 24V	DC 48V	DC 125V	DC 250V
S831D	✓	✓	✓	3PST	ON 2-3 5-6 8-9	NONE	OFF —	30A	30A	15A	7.5A	15A	10A	6A	3A
S832D	✓	✓	✓	3PDT	ON 2-3 5-6 8-9	NONE	ON 2-1 5-4 8-7	30A	30A	15A	7.5A	15A	10A	6A	3A
S833D	✓	✓	✓	3PDT	ON 2-3 5-6 8-9	OFF	ON 2-1 5-4 8-7	30A	30A	15A	7.5A	15A	10A	6A	3A



Notes: Standard Hardware: AT503M Face Hex Nut, AT506M Locking Ring, AT508 Lockwasher, AT527M Backup Hex Nut. See Accessories & Hardware section.

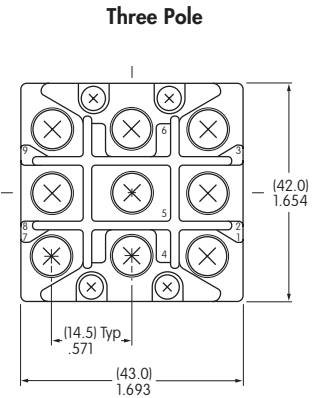
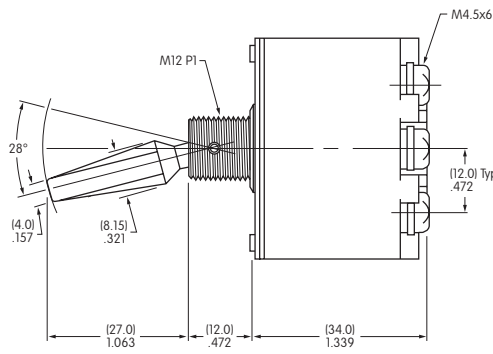
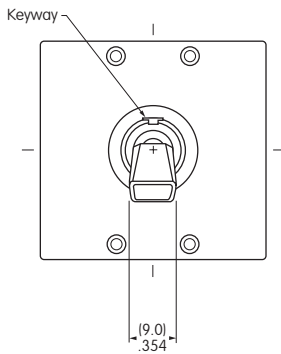

S831D does not have terminals 1, 4 & 7.  
Positive (+) must be connected to end terminals & negative to common poles.



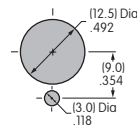

S832D



Maximum Panel Thickness:  
.177" (4.5mm)

## DOUBLE POLE WITH SCREW LUG

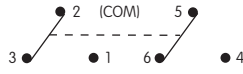
Model	Approvals UL CS	Pole & Throw	Toggle Position/Connected Terminals				Electrical Capacity			
			Down 	Center 	Up 	Resistive			Inductive	
						AC 125V	AC 250V	DC 30V	AC 125V PF 0.6	
S732	— —	DPDT	ON 2-3 5-6	NONE	ON 2-1 5-4	50A	30A	50A	25A	
Throw & Schematics: DPDT 			Note: Terminal numbers are on the switch							

**Notes:** Standard Hardware: AT503M Face Hex Nut, AT506M Locking Ring, AT508 Lockwasher, AT527M Backup Hex Nut. See Accessories & Hardware section.

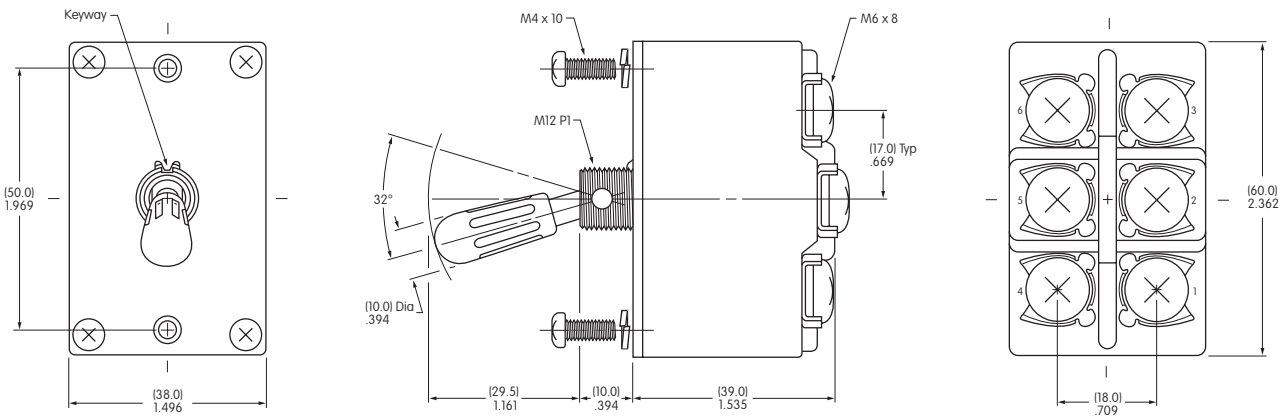

Cap of phenolic resin is black

### Panel Mount with Mounting Screws

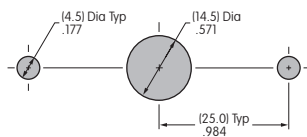

Maximum Panel Thickness: .158" (4.0mm)

### Panel Mount with Bushing Hardware

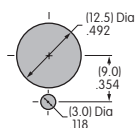

Maximum Panel Thickness: .079" (2.0mm)

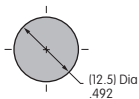

Maximum Panel Thickness: .118" (3.0mm)

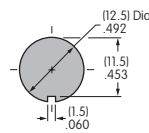

Maximum Panel Thickness: .118" (3.0mm)



**S732**

# Notes

---





# General Specifications

## Electrical Capacity (Resistive Load)

**Power Level (silver):** 6A @ 125V AC or 3A @ 250V AC or 6A @ 12V DC for silver  
**Logic Level (gold):** 0.4VA maximum @ 28V AC/DC maximum for gold  
 (Applicable Range 0.1mA ~ 0.1A @ 20mV ~ 28V)

Note: See Supplement Index for explanation of operating range.

## Other Ratings

**Contact Resistance:** 10 milliohms maximum for silver; 20 milliohms maximum for gold  
**Insulation Resistance:** 1,000 megohms minimum @ 500V DC  
**Dielectric Strength:** 1,000V AC minimum between contacts for 1 minute minimum;  
 1,500V AC minimum between contacts & case for 1 minute minimum  
**Mechanical Life:** 50,000 operations minimum  
**Electrical Life:** 25,000 operations minimum for silver; 50,000 operations minimum for gold  
**Static Capability:** Withstands 20 kilovolts ESD minimum  
**Nominal Operating Force:** 1.9N for .689" (17.5mm) toggle; 2.5N for .433" (11.0mm) toggle  
**Angle of Throw:** 25°

## Materials & Finishes

**Toggle:** Polycarbonate  
**Housing:** Glass fiber reinforced polyamide  
**Sealing Ring:** Nitrile butadiene rubber  
**Base:** Diallyl phthalate (UL94V-0)  
**Movable Contactor:** Phosphor bronze with silver or gold plating  
**Movable Contacts:** Silver alloy or copper with gold plating  
**Stationary Contact:** Silver plus copper with silver plating or copper with gold plating  
**Lamp Contacts:** Beryllium copper with silver plating  
**Power Terminals:** Copper with silver or gold plating  
**Lamp Terminals:** Brass with silver plating

## Environmental Data

**Operating Temperature Range:** -10°C through +55°C (+14°F through +131°F)  
**Humidity:** 90 ~ 95% humidity for 240 hours @ 40°C (104°F)  
**Vibration:** 10 ~ 55Hz with peak-to-peak amplitude of 1.5mm traversing the frequency range & returning in 1 minute; 3 right angled directions for 1.75 hours  
**Shock:** 50G (490m/s<sup>2</sup>) acceleration (tested in 6 right angled directions, with 5 shocks in each direction)

## Installation

**Mounting Torque:** .98Nm (8.67 lb•in) maximum  
**Soldering Time & Temperature:** Manual Soldering: See Profile B in Supplement section.

## Standards & Certifications

**Flammability Standards:** UL94V-0 base

# Distinctive Characteristics

Choice of long or short toggles in translucent colors combine with bright LEDs available in red, amber, and green, plus super bright LEDs available in white, green, and blue.

Black face nut enhances front panel appearance.

Antistatic material used for toggle withstands 20 kilovolts electrostatic discharge.

Panel seal, achieved with use of optional exterior o-ring, conforms to IP65 of IEC60529 Standards.

Interior o-ring protects contacts from oil, dust, water, and other contaminants.

UL94V-0 flammability rated for base.

High insulating barriers protect against crossover.

Terminals are molded in and epoxy sealed to lock out flux, dust, and other contaminants.

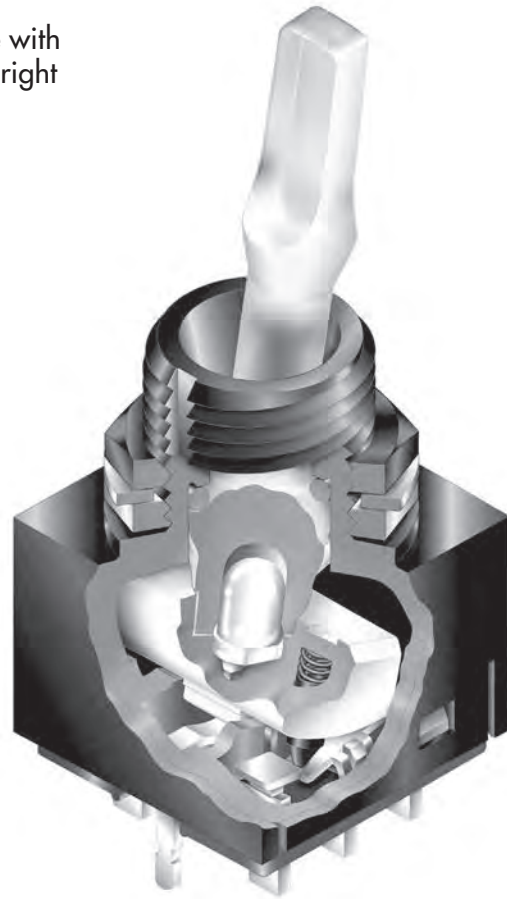

Actual Size

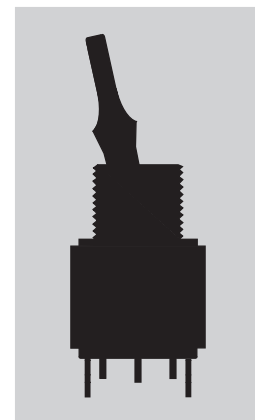
A  
Toggles

Rockers

Pushbuttons

Illuminated PB

Programmable

Key locks

Rotaries

Slides

Tactiles

Tilt

Touch

Indicators

Accessories

Supplement



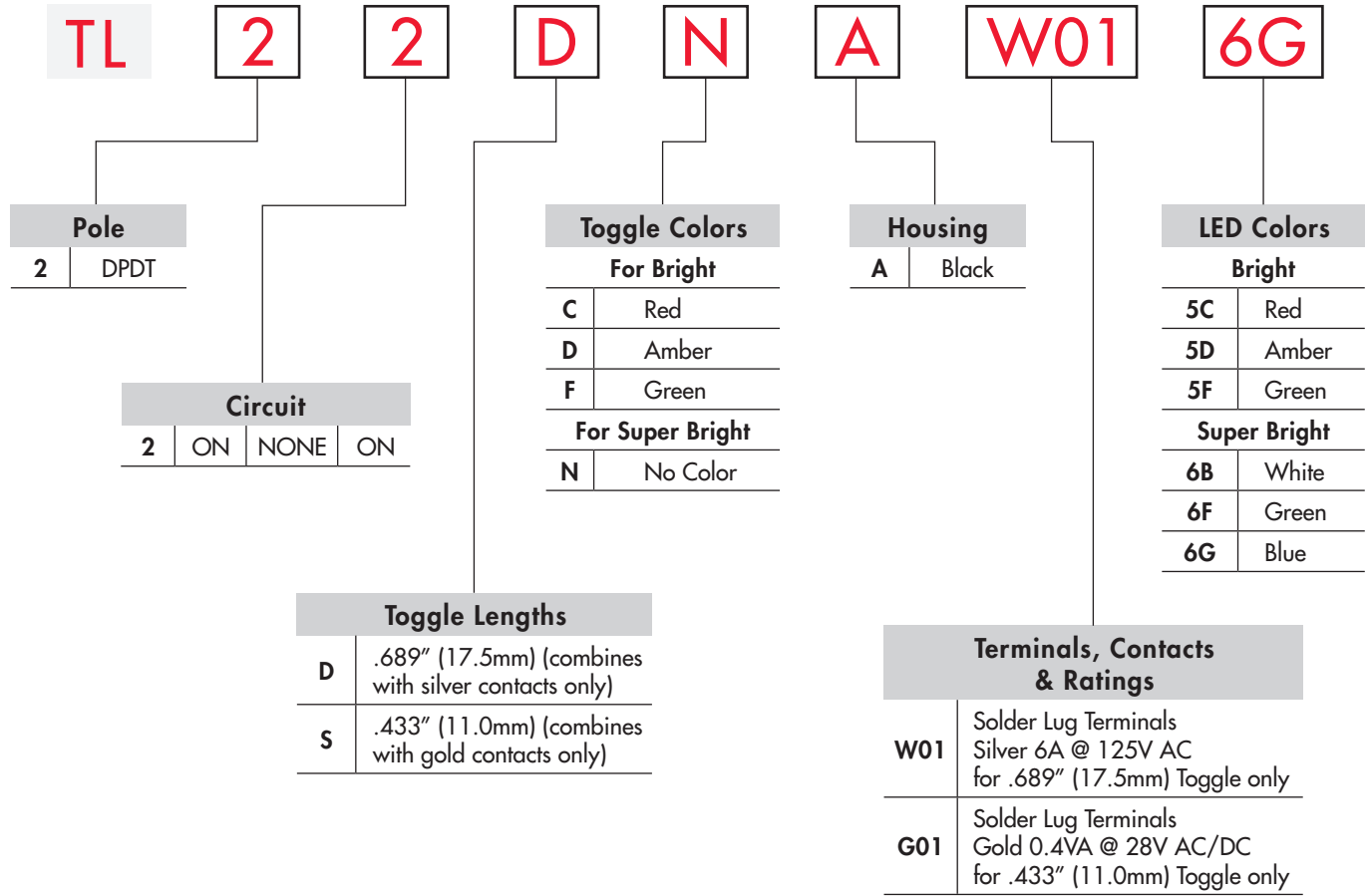

### TYPICAL SWITCH ORDERING EXAMPLE

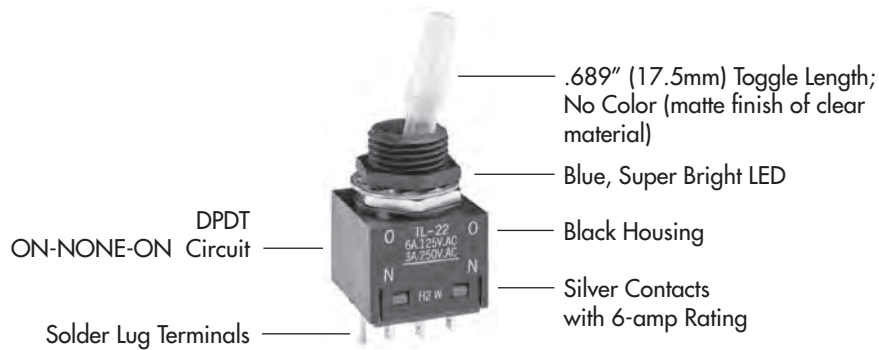

### DESCRIPTION FOR TYPICAL ORDERING EXAMPLE

#### TL22DNAW016G



POLE & CIRCUIT								
Pole	Model	Toggle Position			Connected Terminals			Throw & Power/Lamp Schematics
		Down <small>Keyway</small> 	Center	Up 	Down <small>Keyway</small> 	Center	Up 	
DP	TL22	ON	NONE	ON	1-1b 2-2b	OPEN	1-1a 2-2a	Notes: Terminal numbers are not actually on switch. Lamp circuit is isolated and requires an external power source.  DPDT 

## TOGGLE LENGTHS & COLORS

**D** .689" (17.5mm)

Combines with Silver Contacts only

Material: Polycarbonate

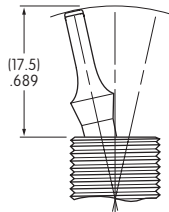

**S** .433" (11.0mm)

Combines with Gold Contacts only

Material: Polycarbonate

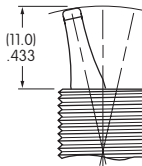

### Colors Available for Bright LED

**C** Red   **D** Amber   **F** Green

### Color Available for Super Bright LED

**N** No Color (Appearance is matte finish of clear material)

## HOUSING

**A** **Black** The housing consists of the one-piece bushing/case of glass fiber reinforced polyamide in black color only.

The diallyl phthalate material used for the base is UL flammability rated 94V-0; housing material is not.

## CONTACT MATERIALS, RATINGS, & TERMINALS

**W** **Silver Contacts Power Level**  
6A @ 125V AC & 3A @ 250V AC  
& 6A @ 12V DC

**01** **Solder Lug Terminals**

**G** **Gold Contacts Logic Level**  
0.4VA maximum @ 28V AC/DC

See Supplement Index for complete explanation of operating range.

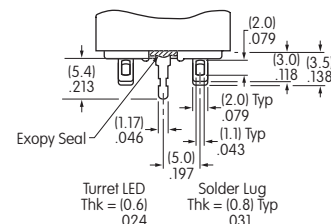

## LED CODES & SPECIFICATIONS

Electrical specifications are determined at a basic temperature of 25°C. Lamp circuit is independent of switch operation.  
 If the source voltage is greater than rated voltage, a ballast resistor is required.  
 The ballast resistor calculation and more lamp detail are shown in Supplement section.

Super Bright LEDs are Electrostatic Sensitive		Colored Toggles			Clear Toggles		
		5 Bright			6 Super Bright		
LED Factory Assembled	Color	<b>C</b>	<b>D</b>	<b>F</b>	<b>B</b>	<b>F</b>	<b>G</b>
<b>Not Available Separately</b>		Red	Amber	Green	White	Green	Blue
Maximum Forward Current	$I_{FM}$	30mA	30mA	50mA	30mA	30mA	30mA
Typical Forward Current	$I_F$	20mA	20mA	20mA	20mA	20mA	20mA
Forward Voltage	$V_F$	2.0V	2.1V	2.27V	3.3V	3.3V	3.3V
Maximum Reverse Voltage	$V_{RM}$	4V	4V	4V	7V	7V	7V
Current Reduction Rate Above 25°C	$\Delta I_F$	0.32mA/°C	0.32mA/°C	0.50mA/°C	0.40mA/°C	0.40mA/°C	0.40mA/°C
Ambient Temperature Range		-10°C ~ +55°C			-10°C ~ +55°C		



## TYPICAL SWITCH DIMENSIONS

### 17.5mm Toggle

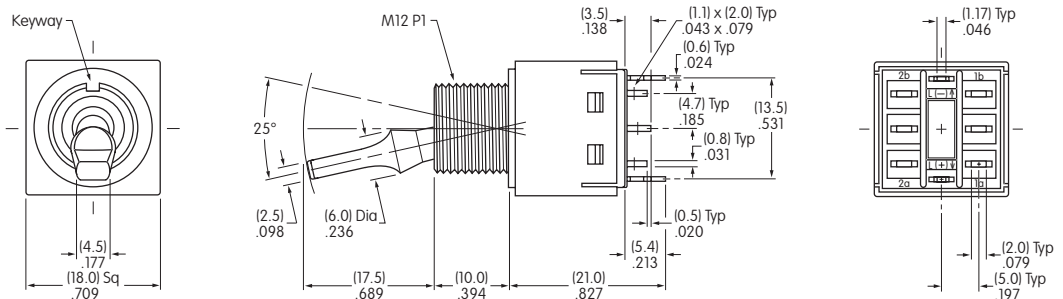

**TL22DNAW016G**

### 11.0mm Toggle

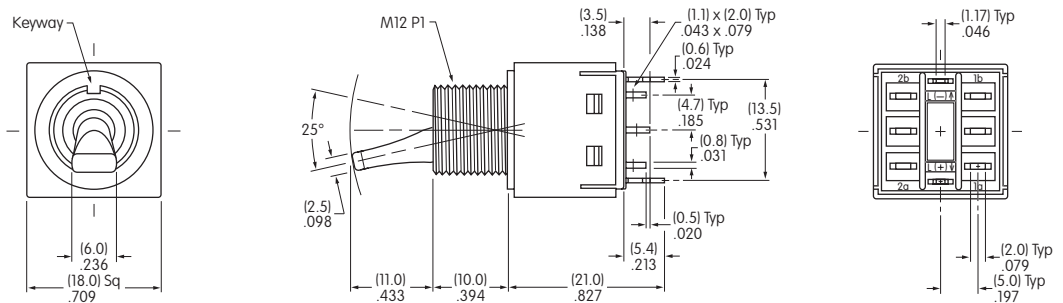

**TL22SCAG015C**

## STANDARD HARDWARE

## OPTIONAL HARDWARE

### AT527MA Black Hex Nut

Use as Face Nut  
Chrome/Steel

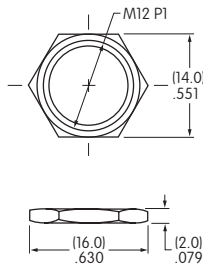

### AT527M Hex Nut

Use as Backup Nut  
Nickel/Steel

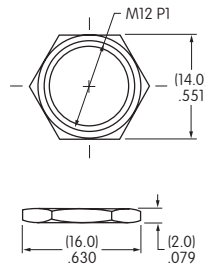

### AT508 Lockwasher

Not to use with Panel Seal  
Steel with Chromate/Zinc

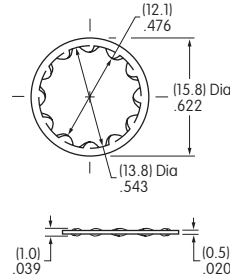

### AT401P O-ring

Use for Panel Seal  
Nitrile butadiene rubber

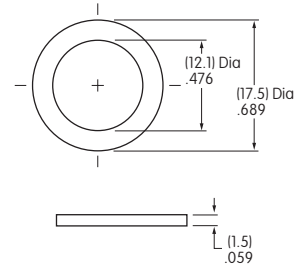

Hardware details in Accessories & Hardware section.

## Panel Cutouts

Maximum Panel Thickness  
with Standard Hardware:

.157" (4.0mm)

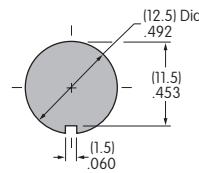
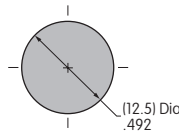

Maximum Panel Thickness  
with Standard Hardware  
& AT401P O-ring:

.236" (6.0mm)

A  
Toggles

Rockers

Pushbuttons

Illuminated PB

Programmable

Key locks

Rotaries

Slides

Tactiles

Tilt

Touch

Indicators

Accessories

Supplement

# General Specifications

## Electrical Capacity (Resistive Load)

**Power Level:** 10A @ 125V AC or 6A @ 250V AC or 10A @ 30V DC

## Other Ratings

**Contact Resistance:** 10 milliohms maximum for solder lug & screw terminal models;  
30 milliohms maximum for wire lead terminal models

**Insulation Resistance:** 200 megohms minimum @ 500V DC

**Dielectric Strength:** 1,500V AC minimum for 1 minute minimum

**Mechanical Life:** 50,000 operations minimum for On-None-Off, On-None-On, & On-Off-On models  
30,000 operations minimum for all other models

**Electrical Life:** 15,000 operations minimum

**Angle of Throw:** 24°

## Materials & Finishes

**Toggle:** Brass with chrome plating

**Bushing & Outer Case:** Glass fiber reinforced polyamide (UL94V-0)

**Inner Case:** Melamine

**Inner Sealing Ring:** Nitrile butadiene rubber for On-None-Off, On-None-On, & On-Off-On models;  
silicone rubber for all other models

**Outer Sealing Ring:** Nitrile butadiene rubber

**Movable Contactor:** Copper with silver plating

**Movable Contacts:** Silver alloy plus copper with silver plating

**Stationary Contacts:** Silver alloy plus copper with silver plating

**Terminals:** Brass with tin plating

**Wire Lead Covers:** Heat resistant polyvinyl chloride (Leads are AWG 16)

## Environmental Data

**Operating Temp Range:** -30°C through +70°C (-22°F through +158°F)

**Humidity:** 90 ~ 95% humidity for 96 hours @ 40°C (104°F)

**Vibration:** 10 ~ 55Hz with peak-to-peak amplitude of 1.5mm traversing the frequency range  
& returning in 1 minute; 3 right angled directions for 2 hours

**Shock:** 50G (490m/s<sup>2</sup>) acceleration (tested in 6 right angled directions, with 5 shocks in each direction)

**Front Panel Seal:** IP67 of IEC60529, dust tight & water protected during temporary immersion for all models;  
optional toggle boot AT401 for additional protection (details at end of WT section)

**Behind Panel Seal:** IP60 of IEC60529, dust tight but not water protected  
for solder lug & screw terminal models  
IP67 of IEC60529, dust tight & water protected during temporary immersion  
for wire lead models

## Installation

**Soldering Time & Temp:** Manual Soldering: See Profile A in Supplement section.

**Mounting Torque:** 1.47Nm (13 lb•in)

## Standards & Certifications

**Flammability Standards:** UL94V-0 outer case

**Wiring Material Standards:** UL AWM 1015 Recognized at Flammability VW-1;  
Temperature Range -20°C ~ +105°C; Maximum Load 600V; AWG 16.  
CSA TEW 105 Certified at Temperature Range -20°C ~ +105°C;  
Maximum Load 600V



# Distinctive Characteristics

Sealing for wire lead models meets IP67 of IEC60529 Standards at front and back panel.

Sealing for solder lug or screw lug models meets IP67 at front panel and IP60 at back panel.

Single unit construction of bushing and case gives added protection from environmental elements.

Epoxy sealed base covered by outer case doubles protection from dust and water (not operable under water or oil).

Specially designed contact mechanism that breaks light contact welds for circuits 11, 12, 21 and 22.

Interlocked movable contact mechanism provides highly reliable switching by minimizing contact bounce over center contact.

Heat resistant resin used for outer housing meets UL94V-0 flammability standard and provides high arc and tracking resistance.

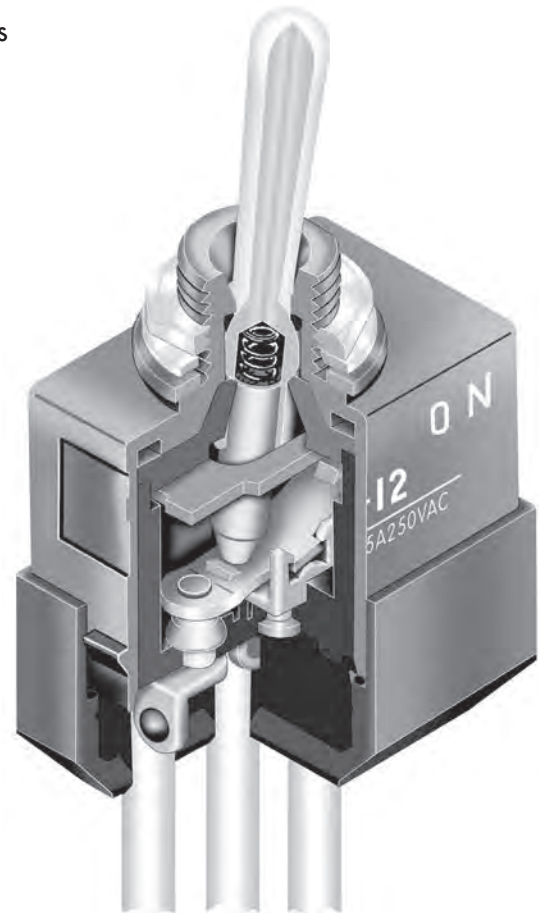

Actual Size

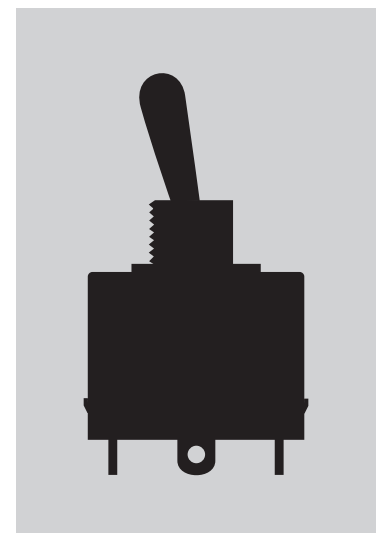

A Toggles

Rockers

Pushbuttons

Illuminated PB

Programmable

Key locks

Rotaries

Slides

Tactiles

Tilt

Touch

Indicators

Accessories

Supplement

## TYPICAL SWITCH ORDERING EXAMPLE

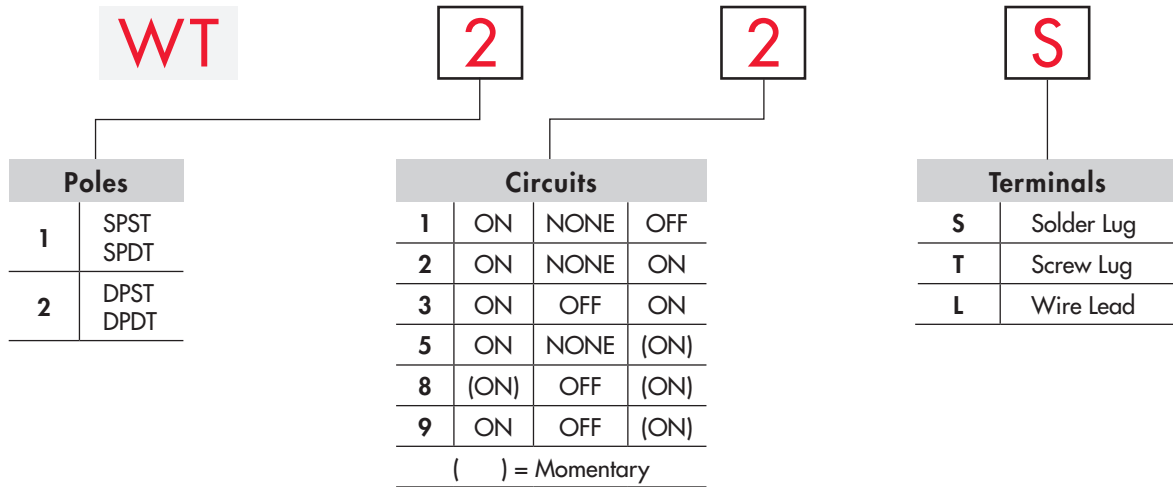

## DESCRIPTION FOR TYPICAL ORDERING EXAMPLE

**WT22S**

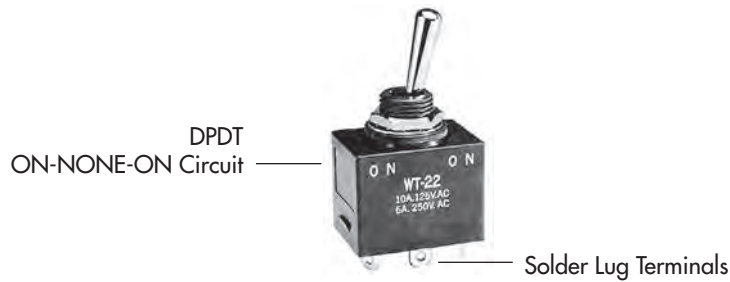

## POLES & CIRCUITS

Pole	Model	Toggle Position ( ) = Momentary			Connected Terminals			Throw & Schematics
		Down <small>Flat</small>	Center	Up	Down <small>Flat</small>	Center	Up	
SP	WT11	ON	NONE	OFF	1a-1b	OPEN	OPEN	SPST 
SP	WT12 WT13 WT15 WT18 WT19	ON ON ON (ON) ON	NONE OFF NONE OFF OFF	ON ON (ON) (ON) (ON)	1-1b	OPEN	1-1a	SPDT 
DP	WT21	ON	NONE	OFF	1a-1b 2a-2b	OPEN	OPEN	DPST 
DP	WT22 WT23 WT25 WT28 WT29	ON ON ON (ON) ON	NONE OFF NONE OFF OFF	ON ON (ON) (ON) (ON)	1-1b 2-2b	OPEN	1-1a 2-2a	DPDT 

Note: Terminal numbers are not actually on wire lead models.

TYPICAL SWITCH DIMENSIONS

Single Throw • Solder Lug

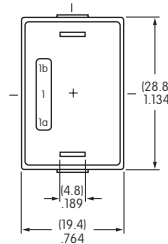
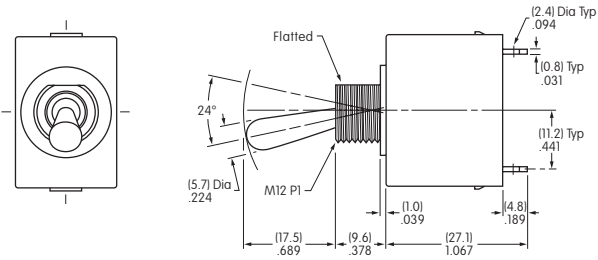

Single Pole

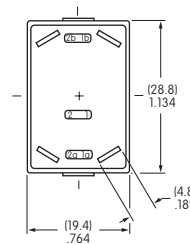

Double Pole



WT11S

Double Throw • Solder Lug

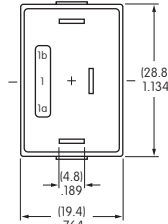
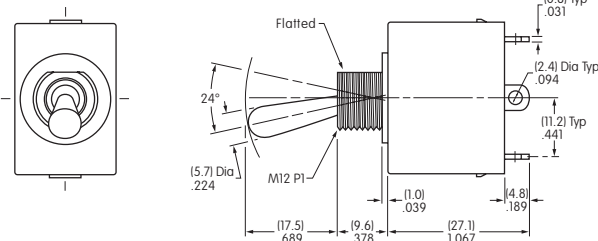

Single Pole

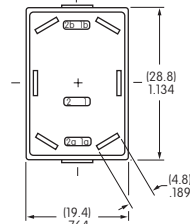

Double Pole



WT22S

Single Throw • Screw Lug

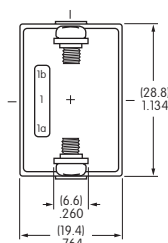
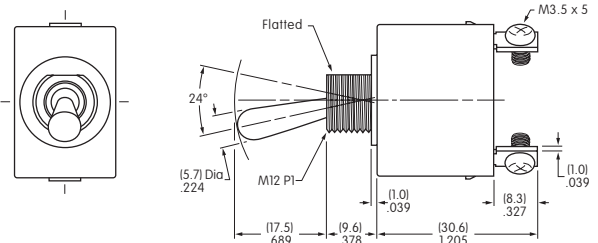

Single Pole

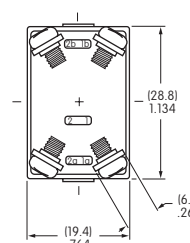

Double Pole



WT21T

### TYPICAL SWITCH DIMENSIONS

#### Double Throw • Screw Lug



**WT22T**

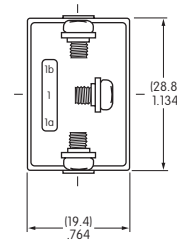
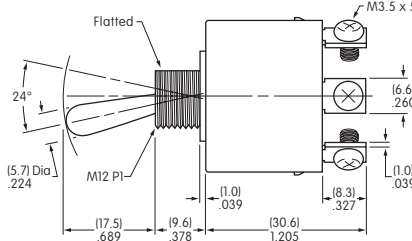
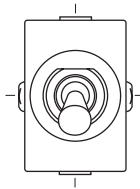

Single Pole

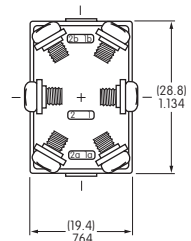

Double Pole

#### Single & Double Pole • Wire Lead



**WT22L**

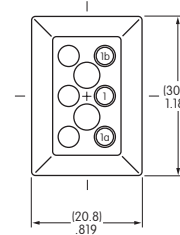
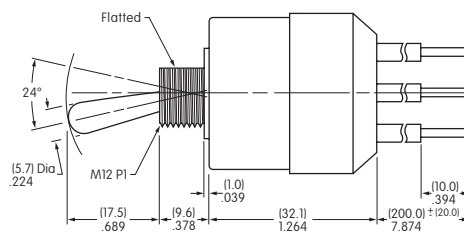
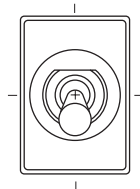

Single Pole

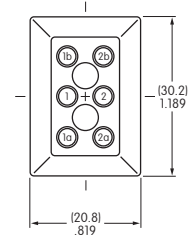

Double Pole

### STANDARD WIRE COLOR SCHEME

Wire leads are covered with heat resistant vinyl in accordance to UL 1015 and CSA TEW 105 Standards for Appliance Wiring Material (AWM).

	Terminal Numbers & Wire Colors					
	1a	1	1b	2a	2	2b
<b>WT11</b>	Black		White			
<b>WT12-19</b>	White	Black	Red			
<b>WT21</b>	Black		White	Blue		Yellow
<b>WT22-29</b>	White	Black	Red	Yellow	Blue	Green

## PANEL CUTOUT & THICKNESS

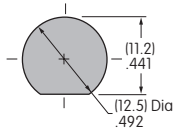

### Maximum Effective Panel Thickness

With Standard Hardware: .157" (4.0mm)  
 With optional Boot Assembly AT401A/H/S: .063" (1.6mm)  
 With optional Boot Assembly AT4181: .083" (2.1mm)

## STANDARD HARDWARE

### AT503M Hex Face Nut

Material: Brass with Chrome Plating  
 1 supplied with each switch

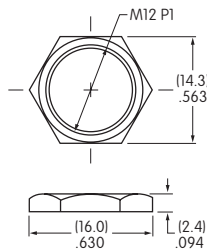

### AT508 Internal Tooth Lockwasher

Material: Steel with Zinc/Chromate  
 1 supplied with each switch

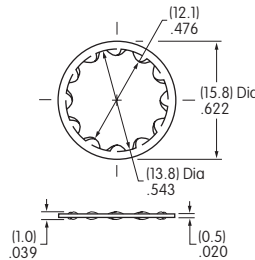

### AT401P O-ring

Material: Nitrile butadiene rubber  
 1 supplied with each switch

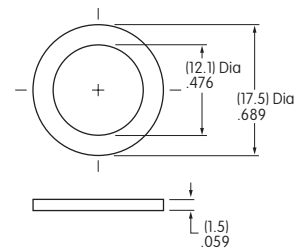

## OPTIONAL ACCESSORIES

### Boot Assemblies for High Particulate Contamination Applications

#### AT401A for Oil Resistance

Boot Material: Black nitrile butadiene rubber  
 Hex Nut Material & Finish: Nickel plated brass  
 O-ring Material: Nitrile butadiene rubber

#### AT401H for Dust & Ozone Resistance

Boot Material: Gray ethylene propylene rubber  
 Hex Nut Material & Finish: Nickel plated brass  
 O-ring Material: Nitrile butadiene rubber

#### AT401S for Retention of Flexibility, Resilience & Tensile Strength Over Wide Temperature Range

Boot Material: Black silicone rubber  
 Hex Nut Material & Finish: Nickel plated brass  
 O-ring Material: Nitrile butadiene rubber

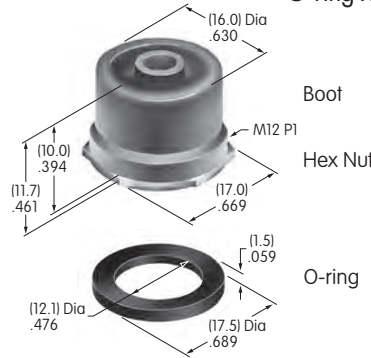
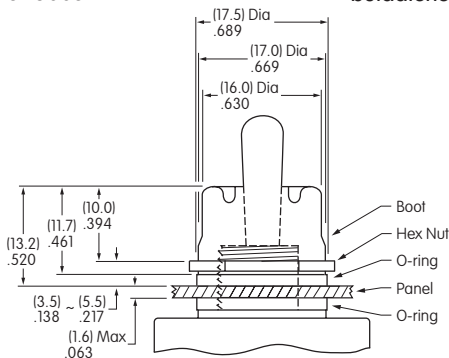

#### AT4181 Splashproof Boot Assembly

Boot Material: Black Silicon rubber  
 Nut Material & Finish: Nickel plated brass  
 O-ring Material: Nitrile butadiene rubber

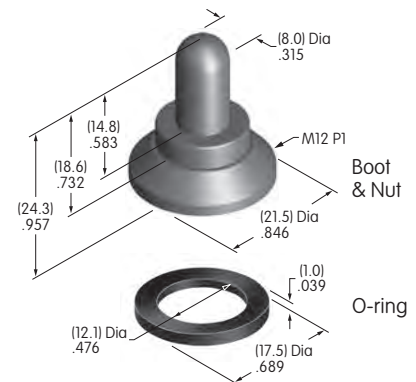
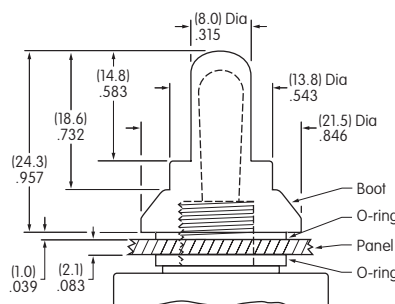

Note: When using boot assemblies AT401A/H/S or AT4181, also use o-ring AT401P from the standard hardware supplied. Hex face nut AT503M and lockwasher AT508 are not used with these boot assemblies.

# Notes

---



Toggles

**Rockers**  
**B**

Pushbuttons

Illuminated PB

Programmable

Keylocks

Rotaries

Slides

Tactiles

Tilt

Touch

Indicators

Accessories

Supplement



**A Series**..... B4  
 Process Sealed  
 0.4VA Logic Level  
 Straight, Right Angle, & Vertical PC



**CW Series**..... B12  
 6A Power Level  
 Solder Lug, Quick Connect, & Right Angle PC  
 Snap-in Mount



**CWWSB Series Illuminated**..... B18  
 Neon; 9A Power Level  
 Quick Connect; Snap-in Mount



**CWSC Series Illuminated**..... B22  
 LED; 9A Power Level  
 Solder Lug/Quick Connect; Snap-in Mount



**G Series**..... B28  
 Process Sealed  
 0.4VA Logic Level  
 Straight PC



**GW Series**..... B32  
 Ultra-Thin  
 0.4VA Logic Level  
 Straight, Right Angle, & Vertical PC



**GW Series Illuminated**..... B36  
 Fully Illuminated Paddle  
 0.4VA Logic Level  
 Straight, Right Angle, & Vertical PC



**JW Series**..... B40  
 Internationally Approved  
 10A & 16A Power Level  
 Solder Lug; Snap-in-Mount



**JWS Series Illuminated & Nonilluminated**... B50  
 Internationally Approved  
 6A & 10A Power Level  
 Solder Lug; Snap-in-Mount



**LW Series Illuminated**..... B56  
 10A Power Level  
 Incandescent Dual Lamps  
 Solder Lug; Snap-in Mount





**M Series**..... B62  
 Snap-in Mount  
 6A Power Level & 0.4VA Logic Level  
 Solder Lug, Quick Connect, Straight PC, & Wirewrap



**M Series**..... B72  
 Bracketed PC Mount  
 6A Power Level & 0.4VA Logic Level  
 Straight, Right Angle, & Vertical PC with Bracket



**M Series**..... B83  
 Flat Frame Mount  
 6A Power Level & 0.4VA Logic Level  
 Solder Lug & Straight PC



**M2100 Series Illuminated**..... B92  
 6A Power Level & 0.4VA Logic Level  
 Solder Lug, Quick Connect, & PC  
 Flat Frame & Snap-in Mount



**M2T Series** ..... B98  
 Process Sealed  
 6A Power Level & 0.4VA Logic Level  
 Straight, Right Angle, & Vertical PC



**MLW Series Illuminated** ..... B106  
 5A Power Level  
 Incandescent, Neon, & LED Lamps  
 Solder Lug; Snap-in Mount



**P Series** ..... B114  
 Internationally Approved  
 10A Power Level  
 Solder Lug, Straight PC, & Quick Connect; Flat Frame Mount



**SW Series** ..... B120  
 15A to 30A Medium & High Capacity  
 Solder Lug & Screw Lug  
 Screw Mount



**WR Series** ..... B124  
 Environmentally Sealed  
 15A Power Level  
 Solder Lug, Screw Lug, Wire Lead, & Quick Connect  
 Snap-in Mount

Rockers	Toggle
Rockers	Pushbuttons
Rockers	Illuminated PB
Rockers	Programmable
Rockers	Keylocks
Rockers	Rotaries
Rockers	Slides
Rockers	Tactiles
Rockers	Tilt
Rockers	Touch
Rockers	Indicators
Rockers	Accessories
Rockers	Supplement

# General Specifications

Toggles

Rockers  
B

Pushbuttons

Illuminated PB

Programmable

Keylocks

Rotaries

Slides

Tactiles

Tilt

Touch

Indicators

Accessories

Supplement

## Electrical Capacity (Resistive Load)

**Logic Level:** 0.4VA maximum @ 28V AC/DC maximum  
(Applicable Range 0.1mA ~ 0.1A @ 20mV ~ 28V)  
Note: Find additional explanation of operating range in Supplement section.

## Other Ratings

**Contact Resistance:** 50 milliohms maximum  
**Insulation Resistance:** 500 megohms minimum @ 500V DC  
**Dielectric Strength:** 500V AC minimum for 1 minute minimum  
**Mechanical Life:** 100,000 operations minimum for On-None-On & On-Off-On  
 50,000 operations minimum for other circuits  
**Electrical Life:** 50,000 operations minimum  
**Nominal Operating Force:** 2.73N (momentary); 1.84N (maintained)  
**Contact Timing:** Nonshorting (break-before-make)  
**Angle of Throw:** 26°

## Materials & Finishes

**Actuator or Toggle:** Nickel plated brass  
**Case Housing:** Glass fiber reinforced polyamide  
**Support Bracket:** Tin plated phosphor bronze  
**Movable Contact:** Phosphor bronze with gold plating  
**Stationary Contacts:** Brass with gold plating  
**Terminals:** Brass with gold plating

## Environmental Data

**Operating Temperature Range:** -30°C through +85°C (-22°F through +185°F)  
**Humidity:** 90 ~ 95% humidity for 240 hours @ 40°C (104°F)  
**Vibration:** 10 ~ 55Hz with peak-to-peak amplitude of 1.5mm traversing the frequency range & returning in 1 minute; 3 right angled directions for 2 hours  
**Shock:** 50G (490m/s<sup>2</sup>) acceleration (tested in 6 right angled directions, with 5 shocks in each direction)

## Installation

**Cap Installation Force:** 39.23N (8.82 lbf) maximum downward force on actuator

## PCB Processing

**Soldering:** Wave Soldering Recommended: See Profile A in Supplement section.  
 Manual Soldering: See Profile B in Supplement section.  
**Cleaning:** Automated cleaning. See Cleaning specifications in Supplement section.

## Standards & Certifications

The A Series rockers have not been tested for UL recognition or CSA certification. These switches are designed for use in a low-voltage, low-current, logic-level circuit. When used as intended in a logic-level circuit, the results do not produce hazardous energy.

# Distinctive Characteristics

Subminiature size saves space on PC boards.

Specifically developed for logic-level applications.

Totally sealed body construction prevents contact contamination and allows time- and money-saving automated soldering and cleaning.

Award-winning STC contact mechanism with benefits unavailable in conventional mechanisms: smoother, positive detent actuation, increased contact stability and unparalleled logic-level reliability. (Additional STC details in Terms & Acronyms; see Supplement section.)

Molded-in, epoxy sealed or ultrasonically welded terminals lock out flux, solvents, and other contaminants.

.100" x .100" (2.54mm x 2.54mm) terminal spacing conforms to standard PC board grid spacing.

Matching indicators available.

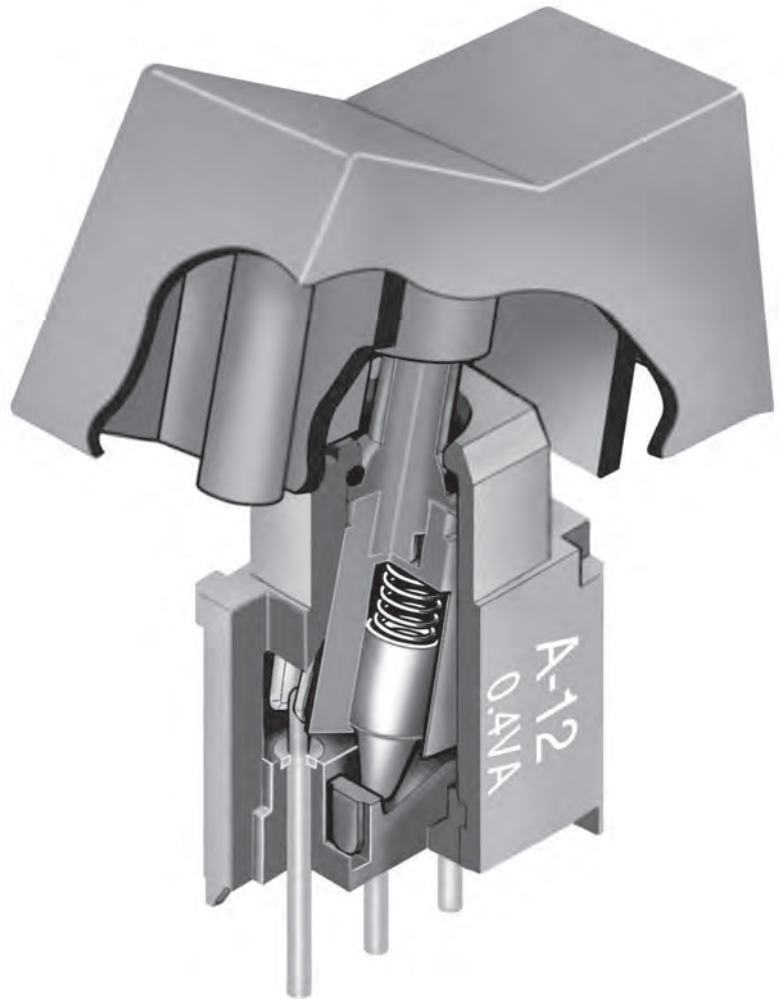

Actual Size

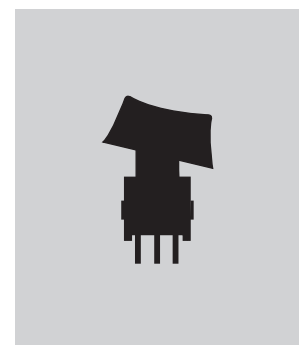

- Supplement
- Accessories
- Indicators
- Touch
- Tilt
- Tactiles
- Slides
- Rotaries
- Key locks
- Programmable
- Illuminated PB
- Pushbuttons
- B** Rockers
- Toggle

### TYPICAL SWITCH ORDERING EXAMPLE

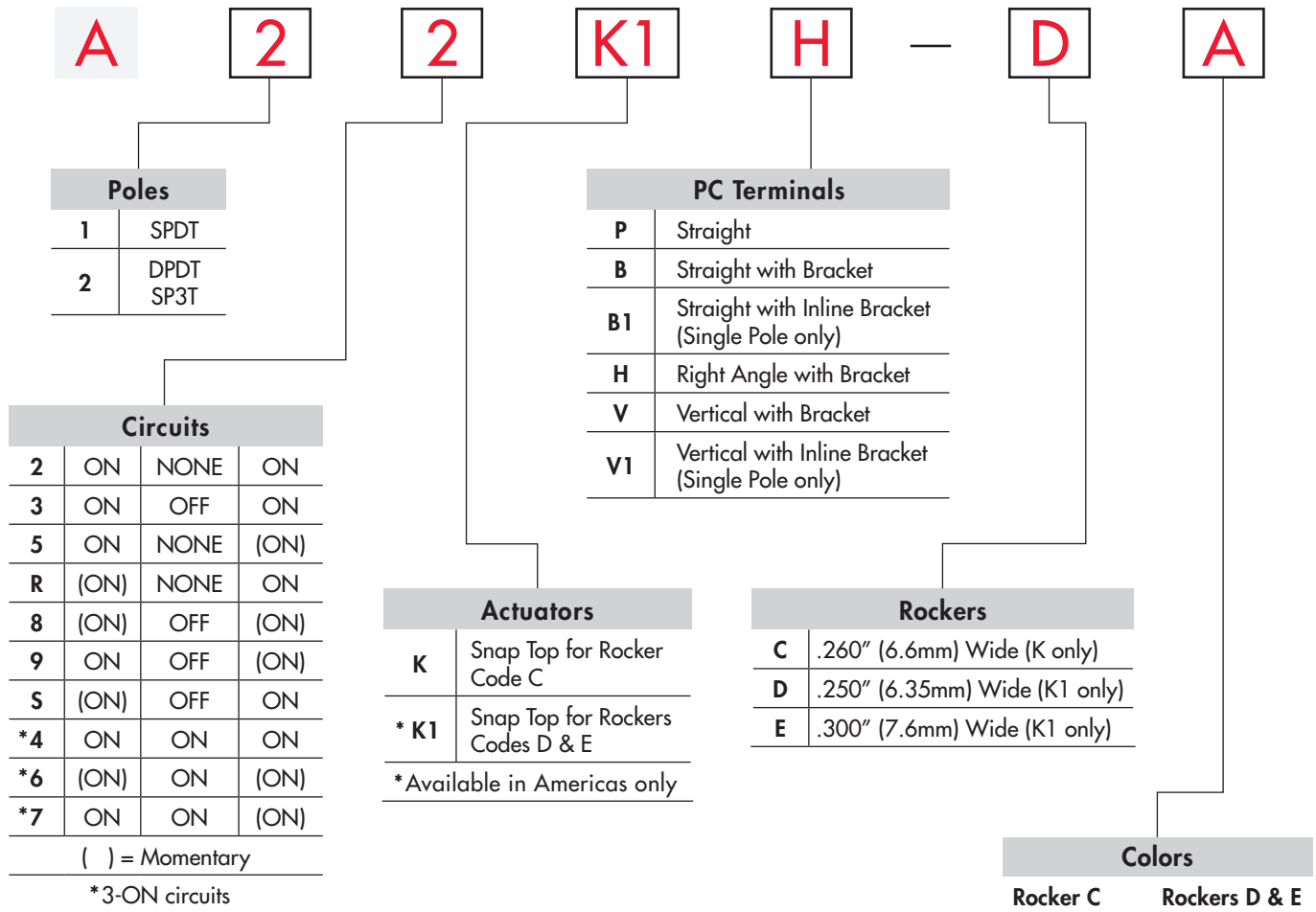

### DESCRIPTION FOR TYPICAL ORDERING EXAMPLE

#### A22K1H-DA



## POLES & CIRCUITS

Pole	Model	Rocker Position ( ) = Momentary			Connected Terminals			Throw & Schematics
		Up	Center	Down	Up	Center	Down	
								Note: Terminal numbers are not actually on the switch.
SP	A12 A13 A15 A1R A18 A19 A1S	ON ON ON (ON) (ON) ON (ON)	NONE OFF NONE NONE OFF OFF OFF	ON ON (ON) ON (ON) (ON) ON	2-3	OPEN	2-1	SPDT 
DP	A22 A23 A25 A2R A28 A29 A2S	ON ON ON (ON) (ON) ON (ON)	NONE OFF NONE NONE OFF OFF OFF	ON ON (ON) ON (ON) (ON) ON	2-3 5-6	OPEN	2-1 5-4	DPDT 

For 3 Throw (3-On)

Connected Terminals & Schematics					External Connection
Pole	Model	Up	Center	Down	
SP	A24 A26 A27	ON (ON) ON   2-3 5-6	ON ON ON   2-3 5-4	ON (ON) (ON)   2-1 5-4	The SP3T model utilizes a double pole base.  External connections must be made during field installation. 

## ACTUATORS

**K** Snap Top

For Rocker AT469

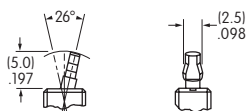

**K1** Snap Top

For Rockers AT062 and AT066

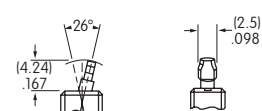

## PC TERMINALS

Use of a support bracket is recommended to increase PCB mounting strength and stability.

**P** Straight

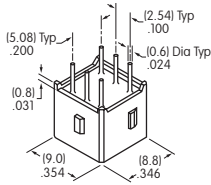

**B** Straight with Bracket

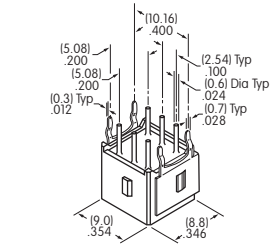

**B1** Straight with Inline Bracket Single Pole only

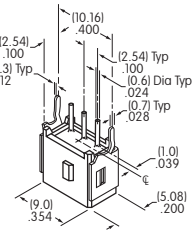

**H** Right Angle with Bracket

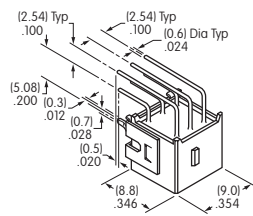

**V** Vertical with Bracket

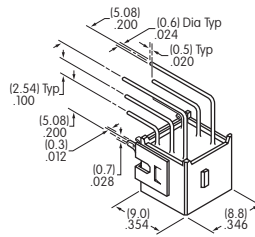

**V1** Vertical with Inline Bracket Single Pole only

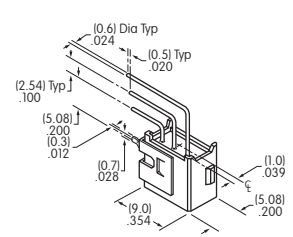

## ROCKERS & COLORS

**C** AT469  
.260" (6.6mm) Wide Rocker

Antirotational  
Material: Polyamide  
Colors Available:  
A, B, C, E, F, G, H

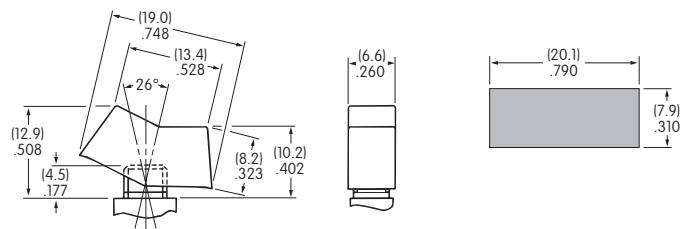

**D** AT062  
.250" (6.35mm) Wide Rocker

Antirotational  
Material: Polyamide  
Colors Available:  
A, B, C

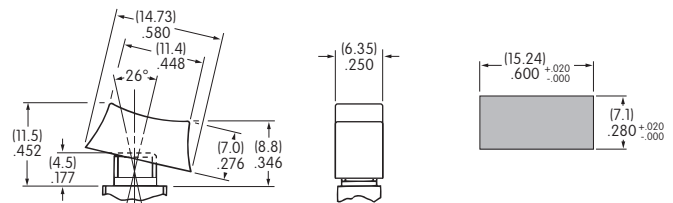

**E** AT066  
.300" (7.6mm) Wide Rocker

Antirotational  
Material: Polyamide  
Colors Available:  
A, B, C

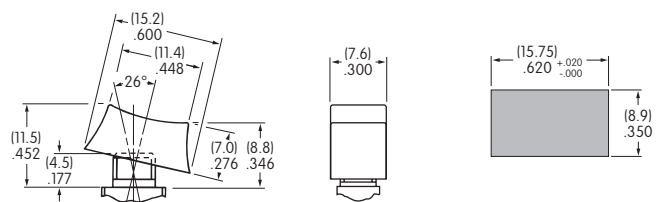

Color Codes:

**A** Black

**B** White

**C** Red

**E** Yellow

**F** Green

**G** Blue

**H** Gray

TYPICAL SWITCH DIMENSIONS

Single Pole

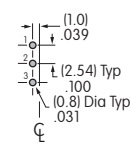
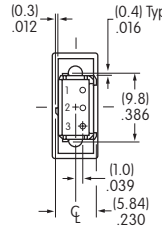
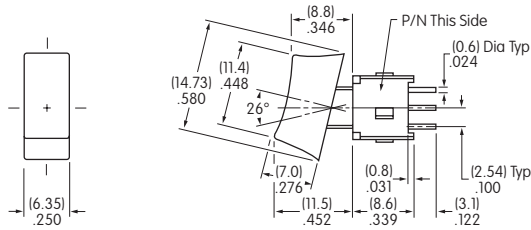

Straight PC



A12K1P-DA

Double Pole

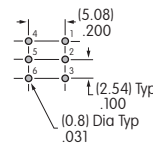
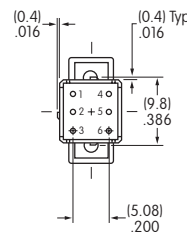
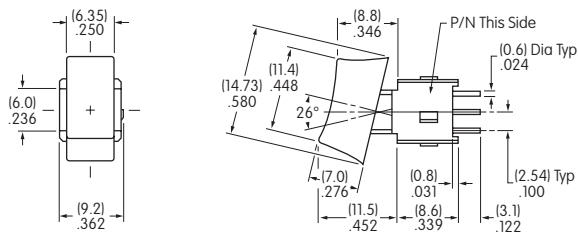

Straight PC



A22K1P-DA

Single Pole

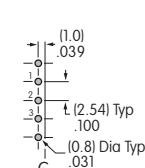
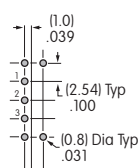
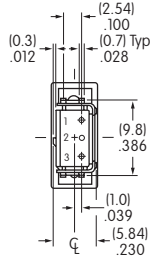
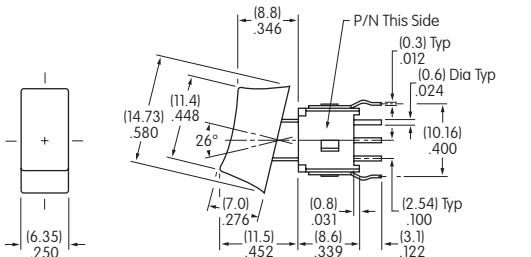

Straight PC • Bracket



A12K1B-DA

Double Pole

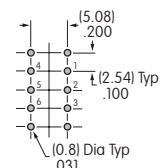
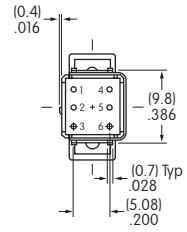
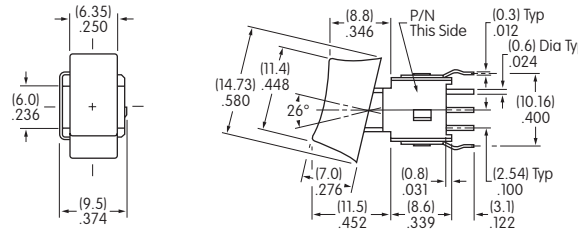

Straight PC • Bracket



A22K1B-DA

Single Pole

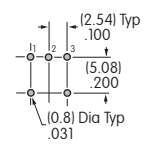
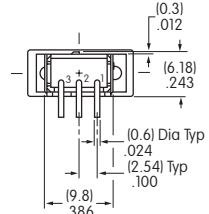
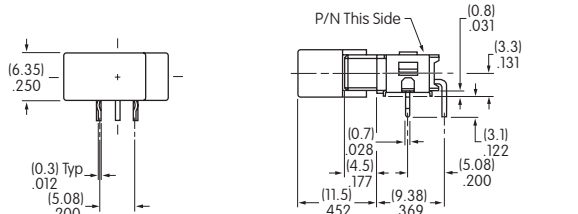

Right Angle PC



A12K1H-DA

## TYPICAL SWITCH DIMENSIONS

### Right Angle PC

### Double Pole

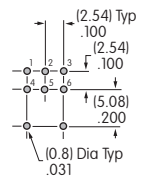
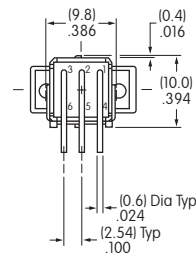
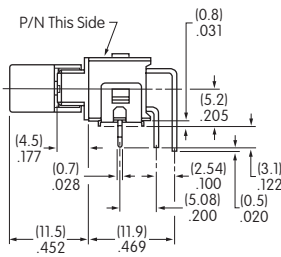
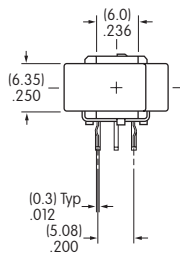

**A22K1H-DA**

### Vertical PC

### Single Pole

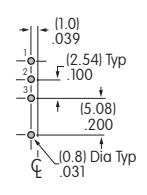
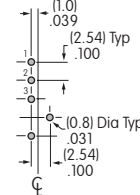
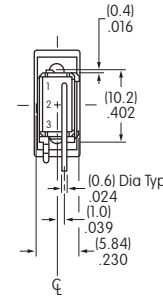
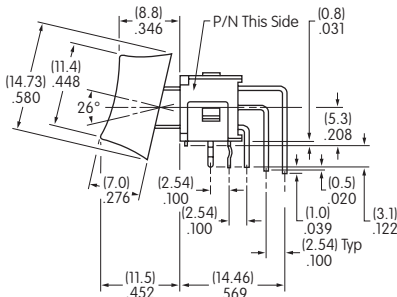
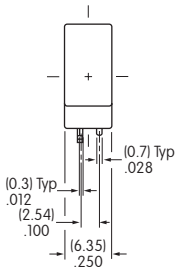

**A12K1V-DA**

V Terminals

V1 Terminals

### Vertical PC

### Double Pole

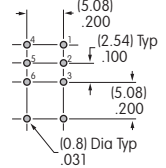
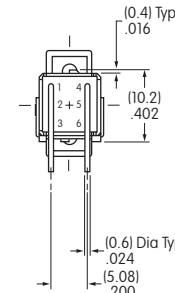
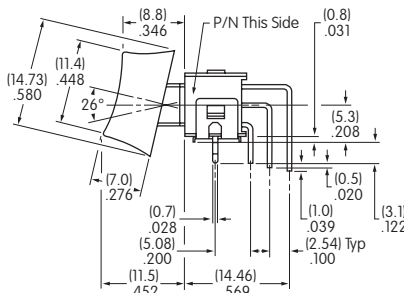
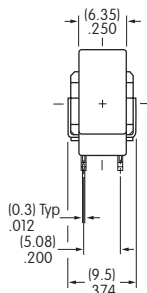

**A22K1V-DA**

## ROCKER MOUNTING PRECAUTION

Rocker switches with vertical and right angle terminals must be mounted so that extension of the PC board beyond the top of the switch housing does not interrupt rocker movement, in turn causing incomplete switching operation.

The MAXIMUM limit of the PC board extension is .051" (1.3mm), as illustrated below.

This precaution does not apply to the double pole switch with right angle terminals due to the extra width of the switch allowing the rocker to clear the PC board.

Side View of Rocker  
Right Angle Mounting PC  
Single Pole Only

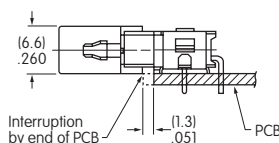

Side View of Rocker  
Vertical Mounting PC  
Single Pole and  
Double Pole

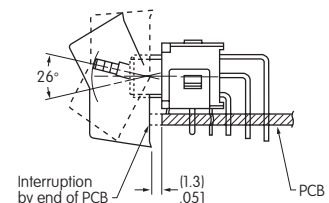





## General Specifications

Toggles

Rockers

Pushbuttons

Illuminated PB

Programmable

Keylocks

Rotaries

Slides

Tactiles

Tilt

Touch

Indicators

Accessories

Supplement

**B**

### CWSA

#### Electrical Capacity

**Power Level:** For Resistive Load 6A @ 250V AC

#### Other Ratings

**Contact Resistance:** 20 milliohms maximum

**Insulation Resistance:** 500 megohms minimum @ 500V DC

**Dielectric Strength:** 1,500V AC minimum between contacts for 1 minute minimum  
3,000V AC minimum between contacts & case for 1 minute minimum

**Mechanical Life:** 30,000 operations minimum

**Electrical Life:** 10,000 operations minimum with Resistive Load & 6,000 operations with Inductive Load

**Nominal Operating Force:** 2.50N

**Angle of Throw:** 30°

**Operating Temperature Range:** -10°C ~ +70°C (+14°F ~ +158°F)

#### Materials & Finishes

**Rocker:** Polycarbonate

**Housing:** Polyamide

**Movable Contactor:** Brass with silver alloy plating

**Movable Contacts:** Silver alloy

**Stationary Contacts:** Silver alloy

**Base:** Laminated thermosetting sheets

**Contact Terminals:** Copper with silver plating

**Common Terminals:** Brass with silver plating

### CWSB

#### Electrical Capacity

**Power Level:** For Resistive Load 6A @ 250V AC

#### Other Ratings

**Contact Resistance:** 20 milliohms maximum

**Insulation Resistance:** 500 megohms minimum @ 500V DC

**Dielectric Strength:** 1,500V AC minimum between contacts for 1 minute minimum  
3,000V AC minimum between contacts & case for 1 minute minimum

**Mechanical Life:** 30,000 operations minimum

**Electrical Life:** 10,000 operations minimum with Resistive Load & 6,000 operations with Inductive Load

**Nominal Operating Force:** 6.50N for single pole models; 10.0N for double pole models

**Angle of Throw:** 30°

**Operating Temperature Range:** -10°C ~ +70°C (+14°F ~ +158°F)

#### Materials & Finishes

**Rocker:** Polycarbonate

**Housing:** Polyamide

**Movable Contactor:** Beryllium copper w/silver alloy plating

**Movable Contacts:** Silver

**Stationary Contacts:** Silver alloy

**Base:** Laminated thermosetting sheets

**Terminals:** Brass with silver plating

### CWT

#### Electrical Capacity

**Power Level:** For Resistive Load 6A @ 125V AC; 3A @ 250V AC; 4A @ 30V DC

#### Other Ratings

**Contact Resistance:** 20 milliohms maximum

**Insulation Resistance:** 1,000 megohms minimum @ 500V DC

**Dielectric Strength:** 1,000V AC minimum between contacts for 1 minute minimum  
1,500V AC minimum between contacts & case for 1 minute minimum

**Mechanical Life:** 50,000 operations minimum

**Electrical Life:** 25,000 operations minimum

**Nominal Operating Force:** 2.0N

**Angle of Throw:** 30°

**Operating Temperature Range:** -25°C ~ +70°C (-13°F ~ +158°F)

#### Materials & Finishes

**Rocker:** Glass fiber reinforced polyamide

**Housing:** Polyamide

**Movable Contactor:** Phosphor bronze w/silver plating

**Movable Contacts:** Silver alloy

**Base:** LCP (Liquid Crystal Polymer)

**Contact Terminals:** Brass + silver with silver plating

**Common Terminals:** Brass with silver plating

# Distinctive Characteristics

## CWSA

- Low cost molded rocker.
- See-saw contact mechanism
- Stable stationary contact construction for high reliability.
- Easily installed with snap-in mounting.
- Large terminal hole dimensioned .067" x .098" (1.7mm x 2.5mm) simplifies wiring and soldering.
- Wave Soldering (PC version): See Profile A in Supplement section.
- Manual Soldering: See Profile A in Supplement section.

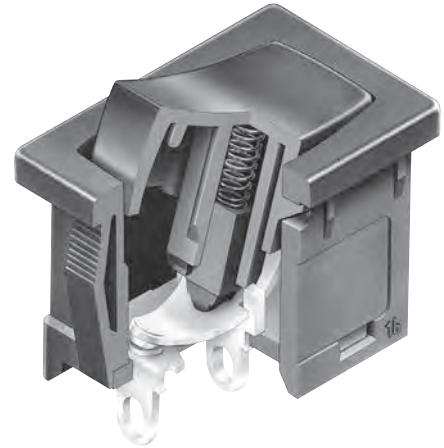

## CWSB

- Low cost molded rocker.
- Snap-acting contact mechanism gives smooth actuation and audible feedback.
- Stable stationary contact construction for high reliability.
- Front panel, snap-in mounting for labor-saving installation.
- Solder lug/quick connect terminals can be used with connectors.
- Manual Soldering: See Profile B in Supplement section.

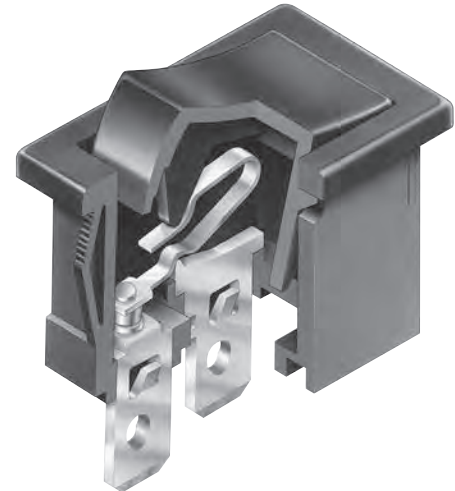

## CWT

- Low cost molded rocker in compact, slim design.
- See-saw contact mechanism
- Outstanding insulation resistance and dielectric strength.
- Dust proof construction protects contact area.
- Stable stationary contact construction for high reliability.
- Front panel, snap-in mounting for labor-saving installation.
- Terminals are molded in and epoxy sealed to lock out flux, dust, and other contaminants.
- Manual Soldering: See Profile A in Supplement section.

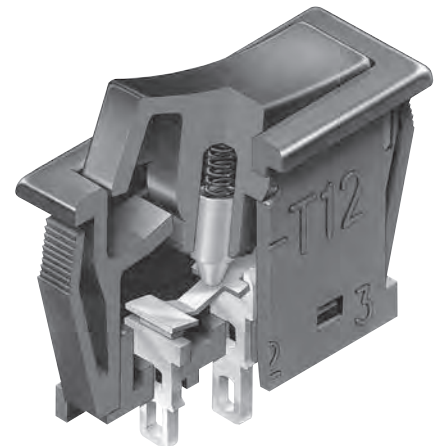

- Supplement
- Accessories
- Indicators
- Touch
- Tilt
- Tactiles
- Slides
- Rotaries
- Key locks
- Programmable
- Illuminated PB
- Pushbuttons
- B** Rockers
- Toggle

### STANDARDS & CERTIFICATIONS

Toggles

Rockers **B**

Pushbuttons

Illuminated PB

Programmable

Keylocks

Rotaries

Slides

Tactiles

Tilt

Touch

Indicators

Accessories

Supplement

### CWSA



Specific CWSA models listed below are qualified for Underwriters Laboratories Inc. recognition and Canadian Standards Association certification. cULus marking on case is standard as noted in following table.

<u>Model</u>	<u>Ratings @ AC</u>	<u>cULus File No.</u>	<u>Marking on Case</u>
CWSA11	6A @ 250V	E44145	Standard
CWSA12	6A @ 250V	E44145	Standard

### CWSB



Specific CWSB models listed below are qualified for Underwriters Laboratories Inc. recognition and Canadian Standards Association certification. cULus marking on case is standard as noted in following table.

<u>Model</u>	<u>Ratings @ AC</u>	<u>cULus File No.</u>	<u>Marking on Case</u>
CWSB11	6A @ 250V	E44145	Standard
CWSB21	6A @ 250V	E44145	Standard

### CWT



Specific CWT model listed below is qualified for Underwriters Laboratories Inc. recognition and Canadian Standards Association certification. cULus marking on case is standard as noted in following table.

<u>Model</u>	<u>Ratings @ AC</u>	<u>cULus File No.</u>	<u>Marking on Case</u>
CWT12	6A @ 125V 3A @ 250V	E44145	Standard

TYPICAL SWITCH ORDERING EXAMPLES

**CWSA** **1** **1** **A** **A** **N** **S**

Pole	
1	SPST & SPDT

Circuits			
1	ON	NONE	OFF
2	ON	NONE	ON

Cap Color	
A	Black

Housing	
A	Black

Inscription	
For SPST & SPDT	
No Code	None
For SPST	
1	Horizontal
2	Vertical
3	Dot Marking

Terminals	
S	Solder Lug
H	Right Angle PC

TYPICAL ORDERING EXAMPLE  
**CWSA11AANS**



**CWSB** **2** **1** **A** **A** **2** **F**

Poles	
1	SPST
2	DPST

Circuit			
1	ON	NONE	OFF

Cap Color	
A	Black

Housing	
A	Black

Inscription	
No Code	None (SPST only)
1	Horizontal
2	Vertical
3	Dot Marking (SPST only)

Terminals	
F	Quick Connect
H	Right Angle PC

TYPICAL ORDERING EXAMPLE  
**CWSB21AA2F**



**CWT** **1** **2** **A** **A** **S1**

Pole	
1	SPDT

Circuit			
2	ON	NONE	ON

Cap Color	
A	Black

Housing	
A	Black

Terminals	
S1	Solder Lug

TYPICAL ORDERING EXAMPLE  
**CWT12AAS1**



## INSCRIPTIONS

**No Code**

**None**

Not available in double pole.

**1**

**Horizontal Orientation**

Only On-None-Off models are available with the horizontal inscription.

**2**

**Vertical Orientation**

Only On-None-Off models are available with the vertical inscription.

**3**

**Dot Marking**

Only Single Pole On-None-Off models are available with the dot inscription.



The IEC symbols for On-Off are supplied with Single Throw models only. Orientation of inscription must be selected. Inscription color is white ink on black.

## TYPICAL SWITCH DIMENSIONS FOR CWSA

**Solder Lug**

**Single Pole • No Inscription**

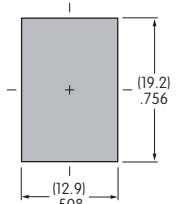
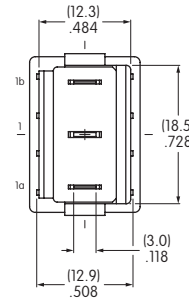
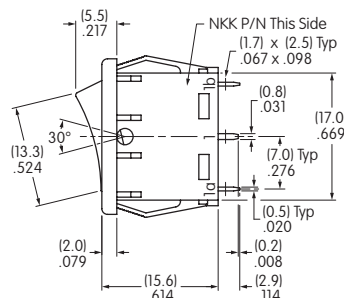
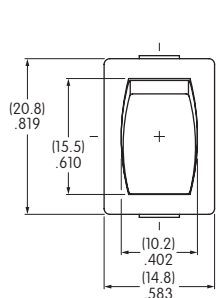

**CWSA12AANS**

Single throw model does not have terminal 1b

Terminal numbers are on side of switch body

Panel Thickness .030" ~ .079" (0.75mm ~ 2.0mm)

**Right Angle**

**Single Pole • Horizontal On-Off Inscription**

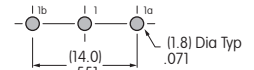
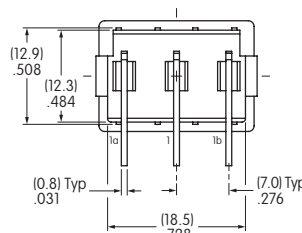
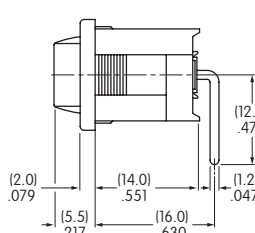
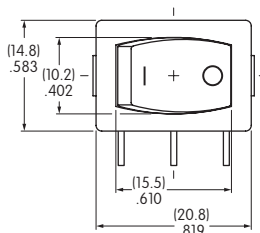

**CWSA11AAN1H**

Single throw model does not have terminal 1b

Terminal numbers are on side of switch body

TYPICAL SWITCH DIMENSIONS FOR CWSB

Double Pole • Vertical On-Off Inscription

Quick Connect

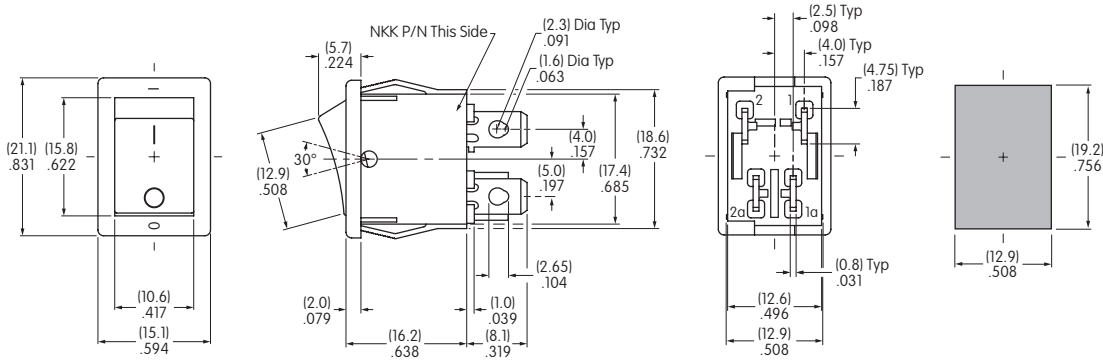

Terminal numbers are on bottom of switch  
Panel Thickness .030" ~ .079" (0.75mm ~ 2.0mm)



CWSB21AA2F

Single Pole • Dot Inscription

Right Angle

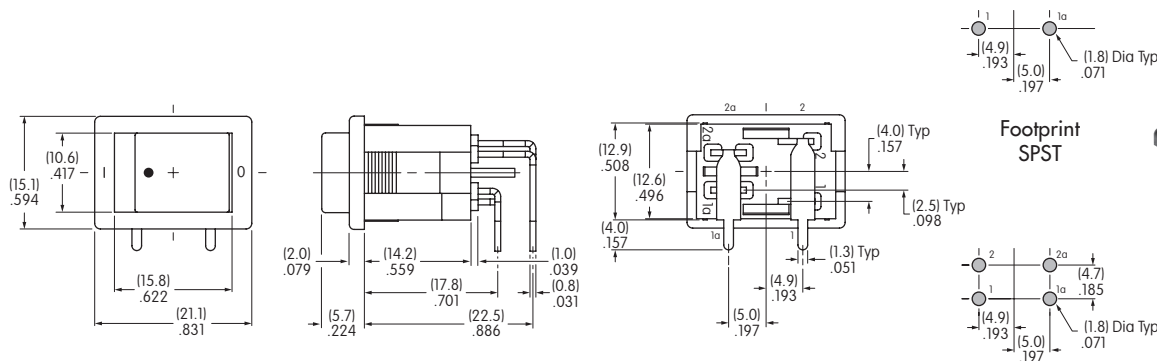

Terminal numbers are on bottom of switch

Footprint DPST



CWSB11AA3H

TYPICAL SWITCH DIMENSIONS FOR CWT

Single Pole • No Inscription

Solder Lug

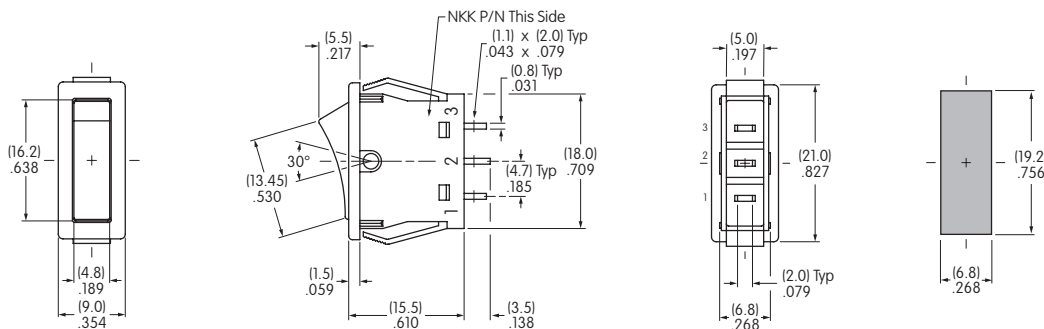

Terminal numbers are on side of switch body

Panel Thickness .030" ~ .079" (0.75mm ~ 2.0mm)



CWT12AA51

# General Specifications

Toggles

Rockers  
B

Pushbuttons

Illuminated PB  
Programmable

Keylocks

Rotaries

Slides

Tactiles

Tilt

Touch

Indicators

Accessories

Supplement

## Electrical Capacity (Resistive Load)

Power Level: 9A @ 125V AC

## Other Ratings

<b>Contact Resistance:</b>	20 milliohms maximum
<b>Insulation Resistance:</b>	500 megohms minimum @ 500V DC
<b>Dielectric Strength:</b>	1,500V AC minimum between contacts for 1 minute minimum; 3,000V AC minimum between contacts & case for 1 minute minimum
<b>Mechanical Life:</b>	30,000 operations minimum
<b>Electrical Life:</b>	10,000 operations minimum
<b>Nominal Operating Force:</b>	10.0N
<b>Angle of Throw:</b>	30°

## Materials & Finishes

<b>Rocker:</b>	Polycarbonate
<b>Housing:</b>	Polyamide
<b>Movable Contactor:</b>	Beryllium copper with silver plating
<b>Movable Contacts:</b>	Silver alloy
<b>Stationary Contacts:</b>	Silver alloy
<b>Switch Terminals:</b>	Brass with silver plating
<b>Lamp Terminals:</b>	Brass with silver plating

## Environmental Data

<b>Operating Temp Range:</b>	-20°C through +85°C (-4°F through +185°F)
<b>Humidity:</b>	90 ~ 95% humidity for 96 hours @ 40°C (104°F)
<b>Vibration:</b>	10 ~ 55Hz with peak-to-peak amplitude of 0.75mm traversing the frequency range & returning in 1 minute; 3 right angled directions for 2 hours
<b>Shock:</b>	50G (490m/s <sup>2</sup> ) acceleration (tested in 6 right angled directions, with 5 shocks in each direction)

## Installation

**Soldering Time & Temp:** Manual Soldering: See Profile B in Supplement section.

## Standards & Certifications

<b>UL:</b>	File No. E44145 9A @ 125V AC Markings on case are standard.
<b>CSA:</b>	File No. 0701166_0_000 9A @ 125V AC Markings on case are standard.



# Distinctive Characteristics

Full face, Neon illumination in choice of red, amber, or green.

Neon lamp suited to 125V AC applications.

9-amp electrical capacity in compact body.

Built-in resistor for direct connection to 125V AC power source.

Low cost molded rocker.

Front panel, snap-in mounting assures labor-saving installation.

Single-break, snap-acting contact mechanism gives smooth actuation and audible feedback.

Quick-make, quick-break characteristic limits arcing and prolongs electrical life.

Stable stationary contact construction for high reliability.

Offset terminal alignment gives outstanding insulation resistance and dielectric strength.

Solder lug/.187" quick connect terminals can be used with connectors.

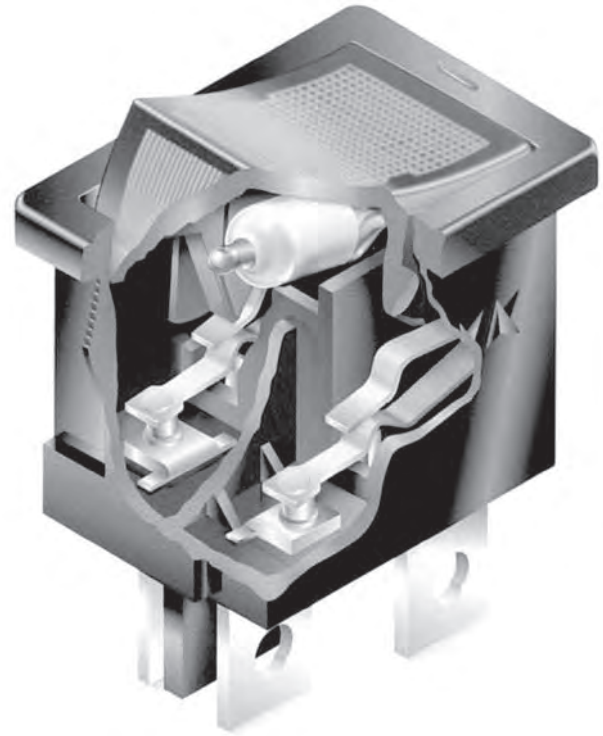

Actual Size

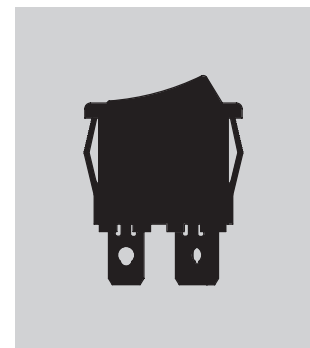

- Supplement
- Accessories
- Indicators
- Touch
- Tilt
- Tactiles
- Slides
- Rotaries
- Key locks
- Programmable Illuminated PB
- Pushbuttons
- B** Rockers
- Toggle

## TYPICAL SWITCH ORDERING EXAMPLE

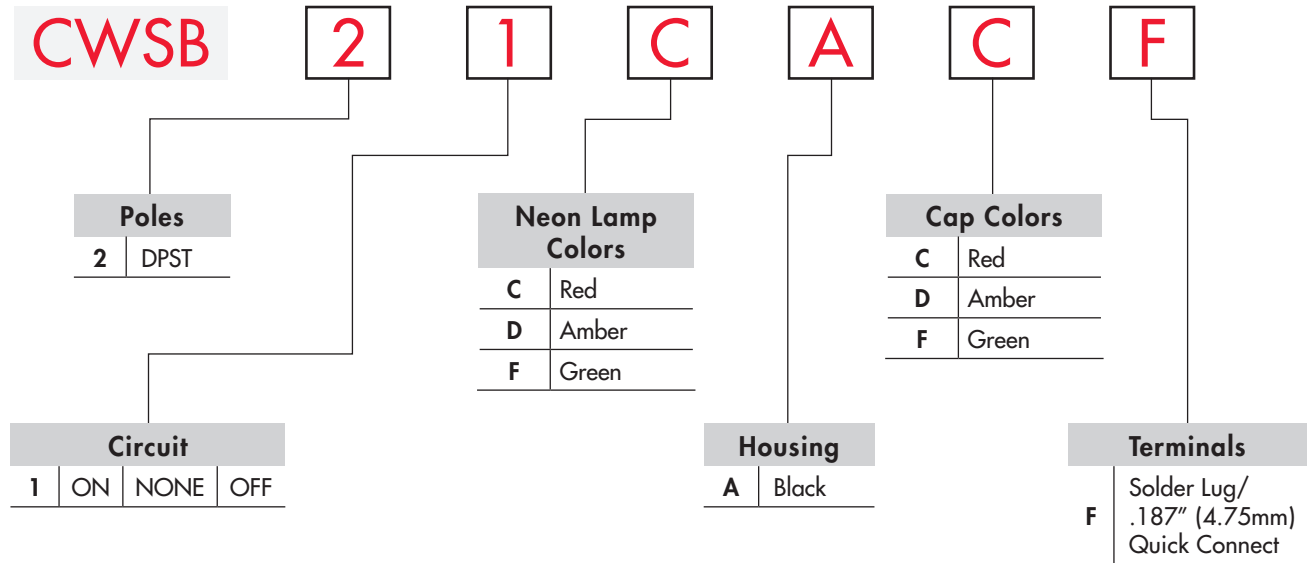

### IMPORTANT:



Switches are supplied with UL & CSA markings on the case. Specific models & ratings noted on the General Specifications page.

## DESCRIPTION FOR TYPICAL ORDERING EXAMPLE

### CWSB21CACF

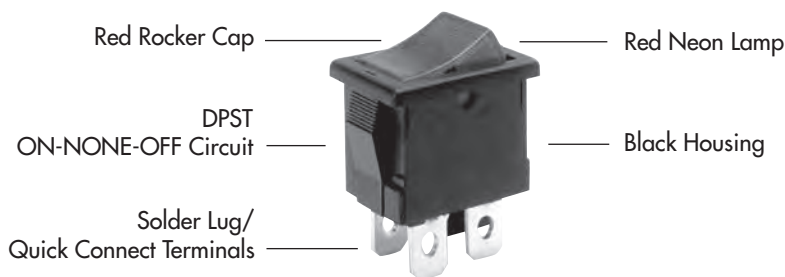

## POLE & CIRCUIT

Pole	Model	Rocker Position			Connected Terminals			Throw & Switch/Lamp Schematic
		Down	Center	Up	Down	Center	Up	
DP	CWSB21	ON	NONE	OFF	1-1a 2-2a	OPEN	OPEN	DPST

Note: Terminal numbers "1a" & "2a" are actually on the switch.

Toggles  
Rockers  
Pushbuttons  
Illuminated PB  
Programmable  
Keylocks  
Rotaries  
Slides  
Tactiles  
Tilt  
Touch  
Indicators  
Accessories  
Supplement

## NEON LAMP COLORS & SPECIFICATIONS

The Neon lamp is factory assembled and not available separately. The lamp circuit is synchronous to switching circuit.

The electrical specifications shown are determined at a basic temperature of 25°C.

Values for the built-in resistors are given in the accompanying table.

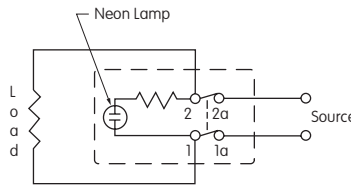

		Colors		
		<b>C</b>	<b>D</b>	<b>F</b>
		Red	Amber	Green
Voltage	V	125V AC	125V AC	125V AC
Internal Series Resistance		33K ohms	33K ohms	68K ohms
Current	I	1.4mA	1.4mA	0.6mA
Endurance	Hours	15,000	15,000	8,000

## HOUSING

**A** Black Housing with Snap-in Mounting

On Off (I O) symbols are molded on the bezel.



## TERMINALS

**F** Solder Lug/.187" (4.75mm) Quick Connect

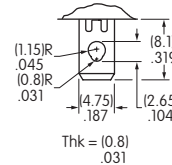

## CAP COLOR CODES

Cap Colors Available

**C** Red    **D** Amber    **F** Green



Caps are factory assembled and are not available separately.

## TYPICAL SWITCH DIMENSIONS

### Double Pole

### Neon Illuminated

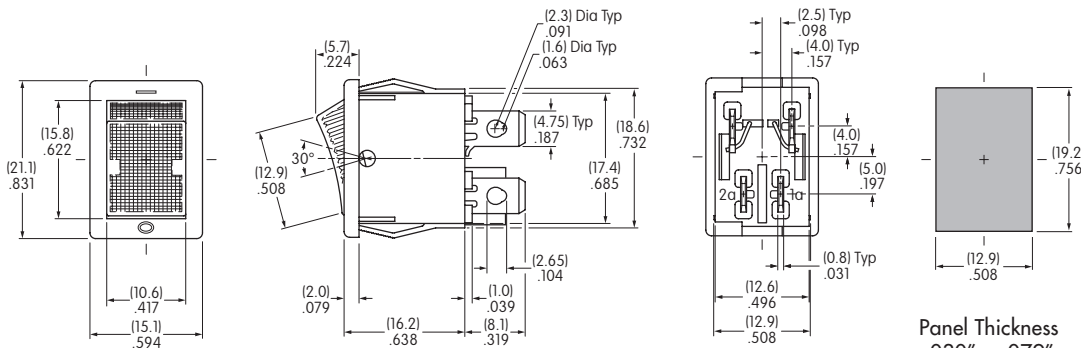

Panel Thickness  
.030" ~ .079"  
(0.75mm ~ 2.0mm)



CWSB21CACF

# General Specifications

Toggles

Rockers  
B

Pushbuttons

Illuminated PB

Programmable

Keylocks

Rotaries

Slides

Tactiles

Tilt

Touch

Indicators

Accessories

Supplement

## Electrical Capacity (Resistive Load)

**Power Level:** 9A @ 125V AC or 6A @ 250V AC

## Other Ratings

**Contact Resistance:** 20 milliohms maximum

**Insulation Resistance:** 500 megohms minimum @ 500V DC

**Dielectric Strength:** 1,500V AC minimum between contacts for 1 minute minimum;  
3,000V AC minimum between contacts & case for 1 minute minimum

**Mechanical Life:** 30,000 operations minimum

**Electrical Life:** 10,000 operations minimum

**Nominal Operating Force:** Single Pole 4.50N; Double Pole 10.0N

**Angle of Throw:** 33°

## Materials & Finishes

**Rocker:** Polycarbonate

**Housing:** Polyamide

**Movable Contact:** Beryllium copper with silver plating

**Movable Contacts:** Silver alloy

**Stationary Contacts:** Silver alloy

**Switch Terminals:** Brass with silver plating

**Lamp Terminals:** Brass with silver plating

## Environmental Data

**Operating Temp Range:** -10°C through +50°C (+14°F through +122°F)

**Humidity:** 90 ~ 95% humidity for 96 hours @ 40°C (104°F)

**Vibration:** 10 ~ 55Hz with peak-to-peak amplitude of 1.5mm traversing the frequency range & returning in 1 minute; 3 right angled directions for 2 hours

**Shock:** 50G (490m/s<sup>2</sup>) acceleration (tested in 6 right angled directions, with 5 shocks in each direction)

## Installation

**Soldering Time & Temp:** Manual Soldering: See Profile A in Supplement section.

## Standards & Certifications

**UL:** File No. E44145

All models recognized at 9A @ 125V AC & 6A @ 250V AC.

cULus marking on case is standard.

# Distinctive Characteristics

Full face, bright LED illumination in choice of red, amber, or green for visible status indication.

9-amp or 6-amp electrical capacity in compact body.

Interior shield prevents contamination of the rocker by carbon from arcing.

Front panel, snap-in mounting assures labor-saving installation.

Single-break, snap-acting contact mechanism gives smooth actuation and audible feedback.

Quick-make, quick-break characteristic limits arcing and prolongs electrical life.

Stable stationary contact construction for high reliability.

Offset terminal alignment gives outstanding insulation resistance and dielectric strength.

Solder lug/.110" quick connect terminals can be used with connectors.

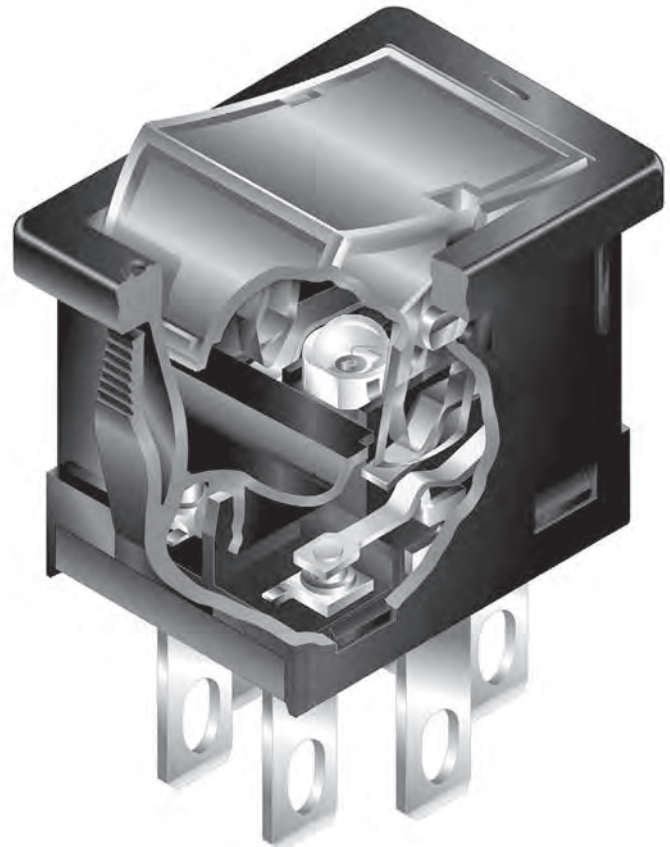

Actual Size

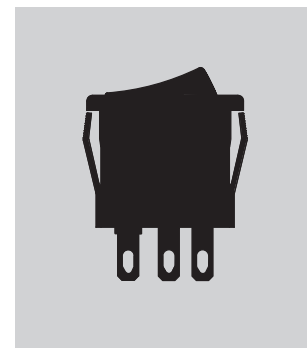

### TYPICAL SWITCH ORDERING EXAMPLE

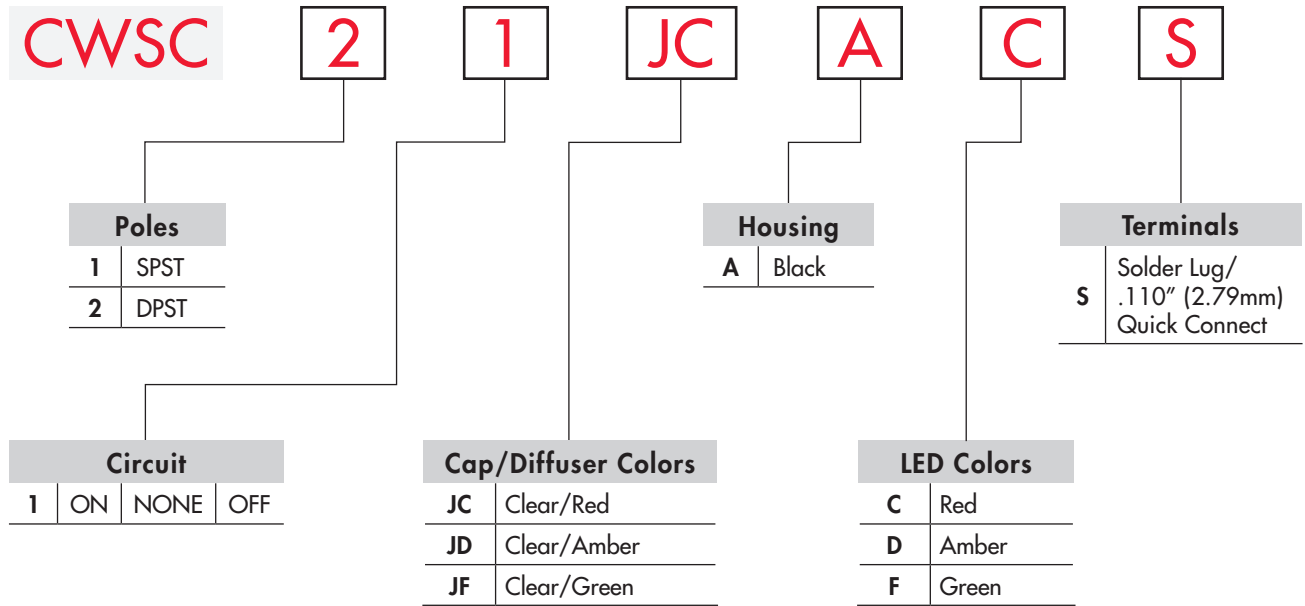

### IMPORTANT:



Switches are supplied with cULus marking on the case. Specific models & ratings noted on the General Specifications page.

### TYPICAL ORDERING EXAMPLE

#### CWSC21JCACS

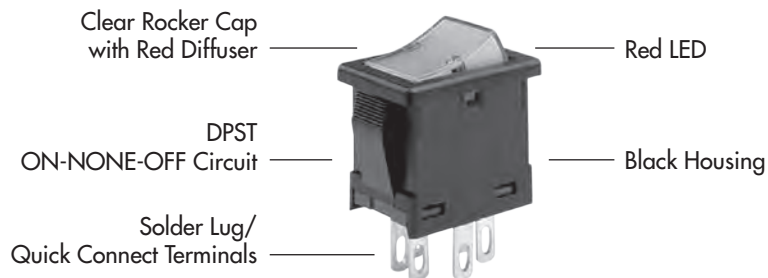

## POLE & CIRCUITS

Pole	Model	Rocker Position			Connected Terminals			Throw & Switch/Lamp Schematics
		Down	Center	Up	Down	Center	Up	
SP	CWSC11	ON	NONE	OFF	1-1a	OPEN	OPEN	Notes: Terminal numbers and polarity are actually on the switch. SPST
DP	CWSC21	ON	NONE	OFF	1-1a 2-2a	OPEN	OPEN	DPST

## CAP TYPES & COLORS

### Rocker Cap/Diffuser

Caps are factory assembled and are not available separately.



### Cap/Diffuser Colors Available

- JC** Clear/Red
- JD** Clear/Amber
- JF** Clear/Green

## HOUSING

### **A** Black Housing with Snap-in Mounting

On Off (I O) symbols are molded on the bezel.



## TERMINALS

### **S** Solder Lug/ .110" (2.79mm) Quick Connect

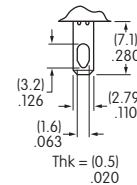

## LED SPECIFICATIONS & COLORS

The LED is factory assembled and not available separately. LED circuit is isolated and requires an external power source. Polarity marks are on the bottom of the switch.

The electrical specifications shown are determined at a basic temperature of 25°C.

If the source voltage exceeds the rated voltage, a ballast resistor is required. The resistor value can be calculated by using the formula in the Supplement.

		<b>C</b> Red	<b>D</b> Amber	<b>F</b> Green
	Colors:	Red	Amber	Green
Maximum Forward Current	$I_{FM}$	30mA	30mA	30mA
Typical Forward Current	$I_F$	20mA	20mA	20mA
Forward Voltage	$V_F$	1.95V	2.0V	2.1V
Maximum Reverse Voltage	$V_{RM}$	5V	5V	5V
Current Reduction Rate above 25°C	$\Delta I_F$	0.41mA/°C	0.29mA/°C	0.39mA/°C
Ambient Temperature Range		-10°C ~ +50°C		

## TYPICAL SWITCH DIMENSIONS

### LED Illuminated

### Single Pole

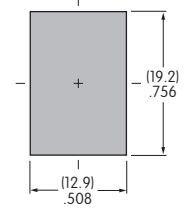
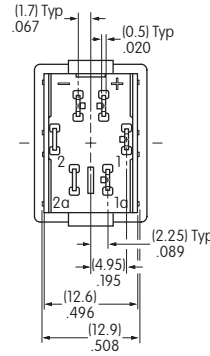
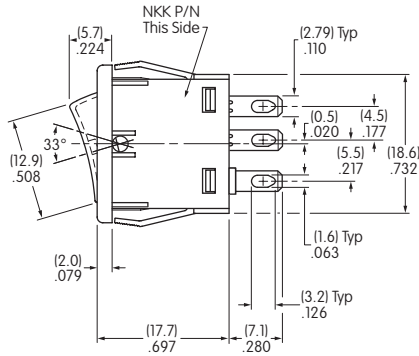
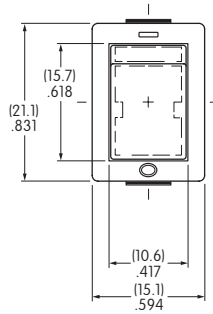

**CWSC11JCACS**

Panel Thickness  
.030" ~ .079"  
(0.75mm ~ 2.0mm)

### LED Illuminated

### Double Pole

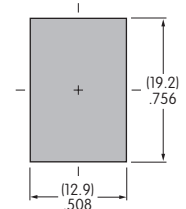
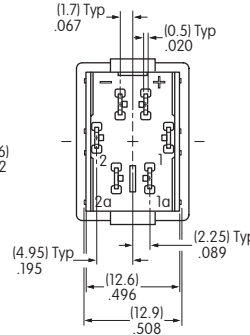
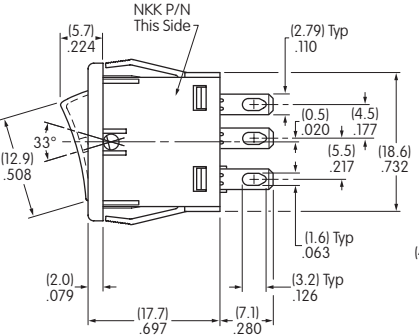
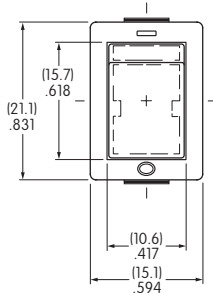

**CWSC21JCACS**

Panel Thickness  
.030" ~ .079"  
(0.75mm ~ 2.0mm)

Toggle

Rockers  
B

Pushbuttons

Illuminated PB

Programmable

Keylocks

Rotaries

Slides

Tactiles

Tilt

Touch

Indicators

Accessories

Supplement





# General Specifications

Toggles

Rockers  
B

Pushbuttons

Illuminated PB

Programmable

Keylocks

Rotaries

Slides

Tactiles

Tilt

Touch

Indicators

Accessories

Supplement

## Electrical Capacity (Resistive Load)

**Logic Level:** 0.4VA maximum @ 28V AC/DC maximum  
(Applicable Range 0.1 mA ~ 0.1 A @ 20mV ~ 28V)  
Note: Find additional explanation of operating range in Supplement section.

## Other Ratings

**Contact Resistance:** 80 milliohms maximum  
**Insulation Resistance:** 500 megohms minimum @ 500V DC  
**Dielectric Strength:** 500V AC minimum for 1 minute minimum  
**Mechanical Life:** 100,000 operations minimum for On-None-On & On-Off-On  
 50,000 operations minimum for other circuits  
**Electrical Life:** 100,000 operations minimum for On-None-On & On-Off-On  
 50,000 operations minimum for other circuits  
**Nominal Operating Force:** .81N for momentary & 1.06N for maintained  
**Angle of Throw:** 28°

## Materials & Finishes

**Actuator:** Glass fiber reinforced polyamide  
**Case:** Glass fiber reinforced polyamide  
**Sealing Rings:** Nitrile butadiene rubber  
**Movable Contact:** Phosphor bronze with gold plating  
**Stationary Contacts:** Phosphor bronze with gold plating  
**Base:** Glass fiber reinforced polyamide  
**Terminals:** Phosphor bronze with gold plating

## Environmental Data

**Operating Temperature Range:** -25°C through +85°C (-13°F through +185°F)  
**Humidity:** 90 ~ 95% humidity for 96 hours @ 40°C (104°F)  
**Vibration:** 10 ~ 55Hz with peak-to-peak amplitude of 1.5mm traversing the frequency range & returning in 1 minute; 3 right angled directions for 2 hours  
**Shock:** 50G (490m/s<sup>2</sup>) acceleration (tested in 6 right angled directions, with 5 shocks in each direction)

## Installation

**Cap Installation Force:** 39.1N (8.8 lbf) maximum downward force on actuator

## PCB Processing

**Soldering:** Wave Soldering Recommended: See Profile A in Supplement section.  
 Manual Soldering: See Profile A in Supplement section.  
**Cleaning:** Automated cleaning. See Cleaning specifications in Supplement section.

## Standards & Certifications

The G Series rockers have not been tested for UL recognition or CSA certification. These switches are designed for use in a low-voltage, low-current, logic-level circuit. When used as intended in a logic-level circuit, the results do not produce hazardous energy.

# Distinctive Characteristics

Ultra-miniature size allows high density mounting, and extremely light weight of 0.25 gram makes these switches ideal for handheld equipment.

Totally sealed body construction prevents contact contamination and allows time-and money-saving automated soldering and cleaning.

Award-winning STC contact mechanism with benefits unavailable in conventional mechanisms: smoother, positive detent actuation, increased contact stability and unparalleled logic-level reliability. (Additional STC details in Terms & Acronyms; see Supplement section.)

.100" x .100" (2.54mm x 2.54mm) terminal spacing conforms to standard PC board grid spacing. Round terminals facilitate easier through-hole mounting on PC boards.

Matching indicators available.

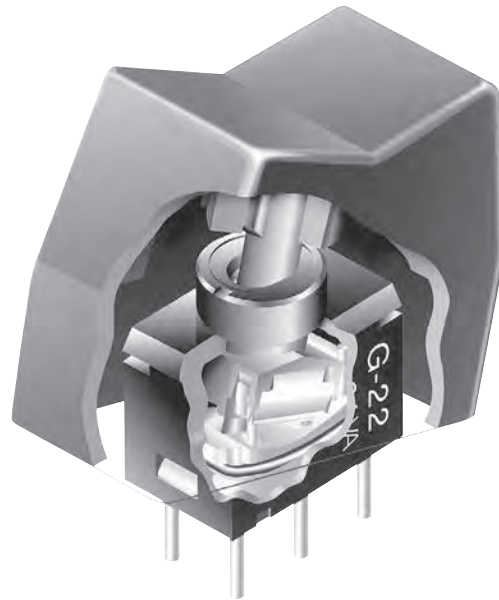

Actual Size

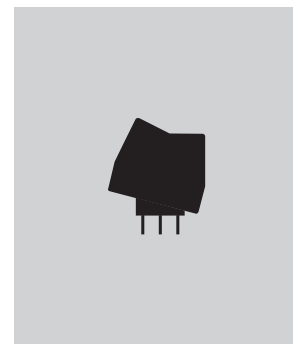

- Supplement
- Accessories
- Indicators
- Touch
- Tilt
- Tactiles
- Slides
- Rotaries
- Key locks
- Programmable
- Illuminated PB
- Pushbuttons
- B** Rockers
- Toggle

### TYPICAL SWITCH ORDERING EXAMPLE

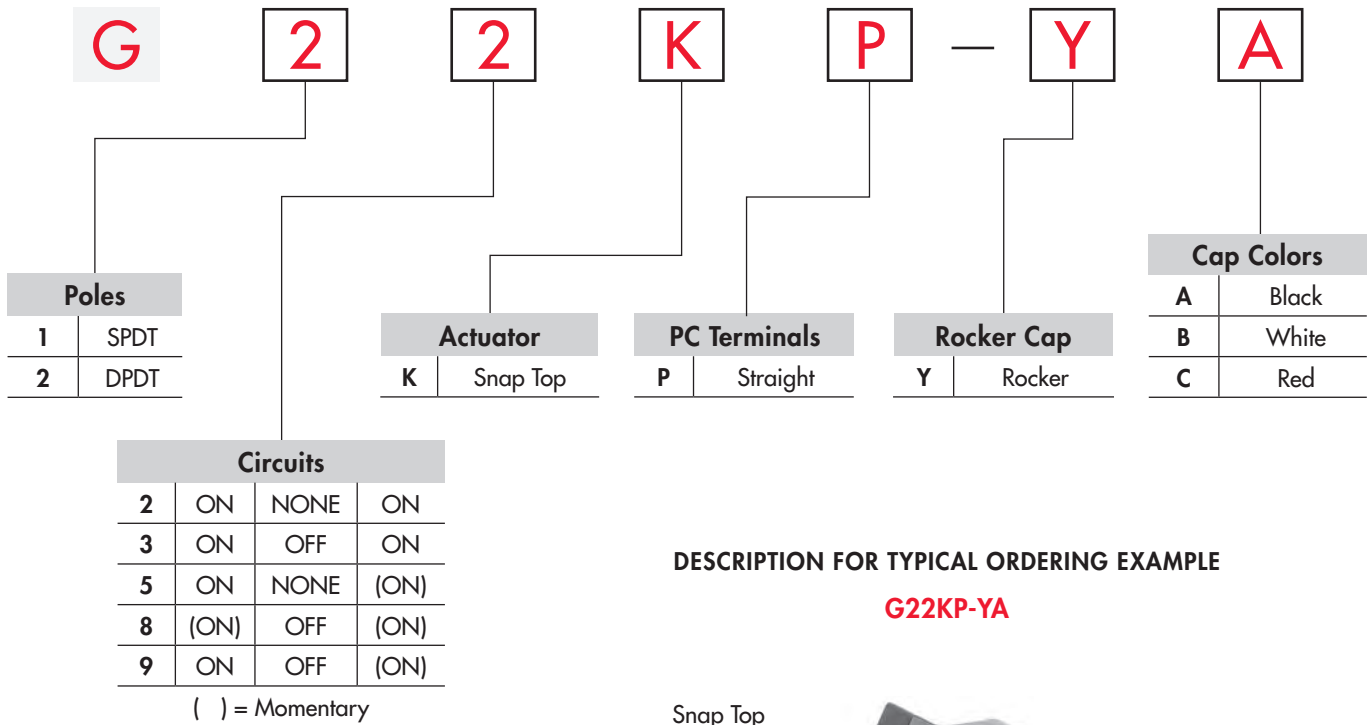

### DESCRIPTION FOR TYPICAL ORDERING EXAMPLE

**G22KP-YA**

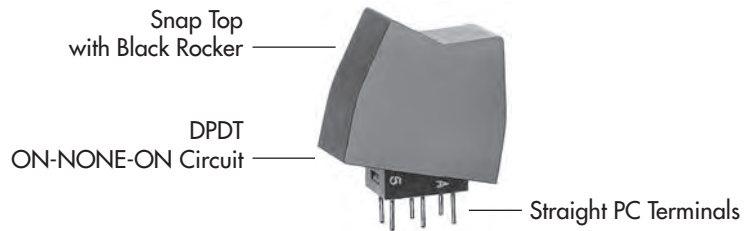

### POLES & CIRCUITS

Pole	Model	Rocker Position ( ) = Momentary			Connected Terminals			Throw & Schematics
		Up	Center	Down	Up	Center	Down	
SP	G12 G13 G15 G18 G19	ON ON ON (ON) ON	NONE OFF NONE OFF OFF	ON ON (ON) (ON) (ON)	5-6	OPEN	5-4	Note: Terminal numbers are not actually on the switch.  SPDT 
DP	G22 G23 G25 G28 G29	ON ON ON (ON) ON	NONE OFF NONE OFF OFF	ON ON (ON) (ON) (ON)	5-6 2-3	OPEN	5-4 2-1	DPDT 

ACTUATOR

**K** Snap Top for Rocker

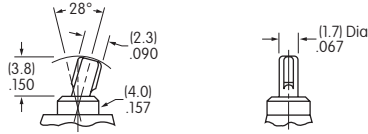

PC TERMINALS

**P** Straight

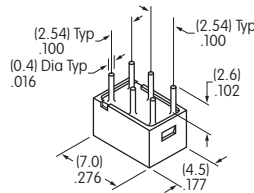

ROCKER CAP & COLORS

**Y** AT4062 Rocker

Material: Polyamide  
Finish: Matte

Colors Available:  
A, B, C



Actual Size

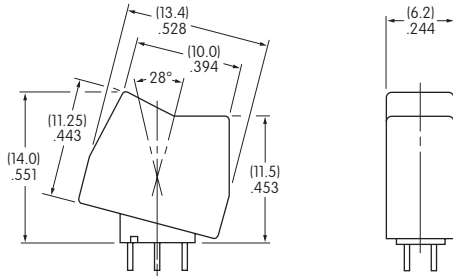

Color Codes: **A** Black **B** White **C** Red

TYPICAL SWITCH DIMENSIONS

Single & Double Pole

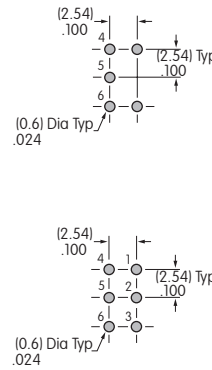
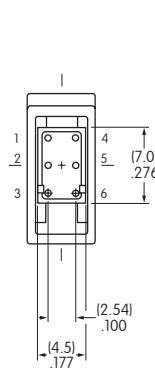
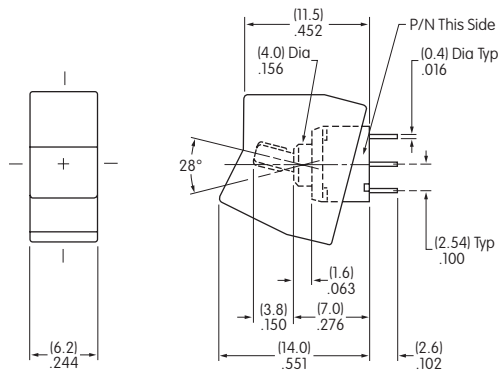

Straight PC



On single pole models positions 1 & 3 are support pins.

G23KP-YA

# General Specifications

Toggles

Rockers  
B

Pushbuttons

Illuminated PB

Programmable

Keylocks

Rotaries

Slides

Tactiles

Tilt

Touch

Indicators

Accessories

Supplement

## Electrical Capacity (Resistive Load)

**Logic Level:** 0.4VA maximum @ 28V AC/DC maximum  
(Applicable Range 0.1 mA ~ 0.1A @ 20mV ~ 28V)  
Note: Find additional explanation of operating range in Supplement section.

## Other Ratings

**Contact Resistance:** 80 milliohms maximum  
**Insulation Resistance:** 500 megohms minimum @ 500V DC  
**Dielectric Strength:** 500V AC minimum for 1 minute minimum  
**Mechanical Life:** 50,000 operations minimum  
**Electrical Life:** 50,000 operations minimum  
**Nominal Operating Force:** For Rockers 1.70N; for Paddles 1.30N  
**Angle of Throw:** 28°

## Materials & Finishes

**Actuator:** Glass fiber reinforced polyamide (UL94V-0)  
**Case:** Glass fiber reinforced polyamide (UL94V-0)  
**Sealing Ring:** Nitrile butadiene rubber  
**Movable Contact:** Phosphor bronze with gold plating  
**Stationary Contacts:** Phosphor bronze with gold plating  
**Base:** Glass fiber reinforced polyamide (UL94V-0)  
**Mounting Bracket:** Phosphor bronze with tin plating  
**Terminals:** Phosphor bronze with gold plating

## Environmental Data

**Operating Temperature Range:** -30°C through +85°C (-22°F through +185°F)  
**Humidity:** 90 ~ 95% humidity for 240 hours @ 40°C (104°F)  
**Vibration:** 10 ~ 55Hz with peak-to-peak amplitude of 1.5mm traversing the frequency range & returning in 1 minute; 3 right angled directions for 2 hours  
**Shock:** 50G (490m/s<sup>2</sup>) acceleration (tested in 6 right angled directions, with 5 shocks in each direction)

## PCB Processing

**Soldering:** Wave Soldering Recommended: See Profile A in Supplement section.  
Manual Soldering: See Profile A in Supplement section..  
**Cleaning:** These devices are not process sealed. Hand clean locally using alcohol based solution.

## Standards & Certifications

**Flammability Standards:** UL94V-0 actuator & case/base

The GW Series rockers have not been tested for UL recognition or CSA certification. These switches are designed for use in a low-voltage, low-current, logic-level circuit. When used as intended in a logic-level circuit, the results do not produce hazardous energy.

# Distinctive Characteristics

Various colored rockers and paddles.

Combination of dust cover and closely fit housing, actuator, and interior pivot provides protection for contacts.

Detent mechanism design of coil spring, plunger, and plastic detent results in crisp and positive actuation.

Extremely thin size allows high density PCB mounting and makes these switches ideal for handheld equipment.

Award-winning STC contact mechanism with benefits unavailable in conventional mechanisms: smoother, positive detent actuation, increased contact stability and unparalleled logic-level reliability. (Additional STC details in Terms & Acronyms; see Supplement section.)

Molded-in, epoxy sealed terminals lock out flux and other contaminants.

.100" x .100" (2.54mm x 2.54mm) terminal spacing conforms to standard PC board grid spacing for straight and angle mounting.



Actual Size

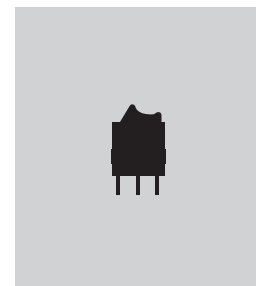

## TYPICAL SWITCH ORDERING EXAMPLE

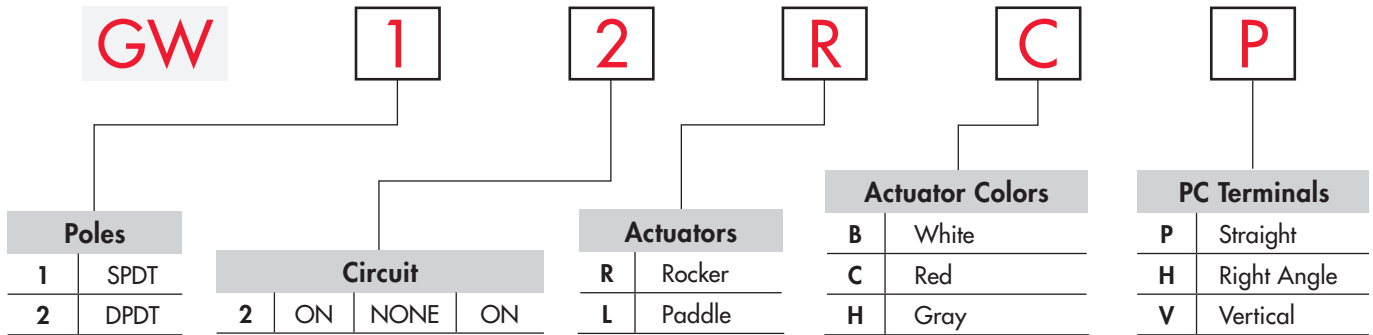

## DESCRIPTION FOR TYPICAL ROCKER ORDERING EXAMPLE

### GW12RCP



## POLES & CIRCUIT

Pole	Model	Rocker Position			Connected Terminals			Throw & Schematics
		Up	Center	Down	Up	Center	Down	
SP	GW12	ON	NONE	ON	5-6	OPEN	5-4	SPDT 
DP	GW22	ON	NONE	ON	5-6 2-3	OPEN	5-4 2-1	DPDT 

Note: Terminal numbers are not actually on the switch.

## TYPICAL SWITCH DIMENSIONS

### Straight PC



GW12RCP

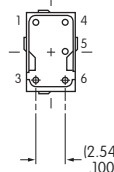
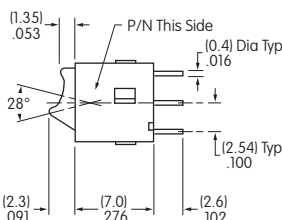
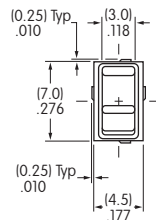

### Single Pole

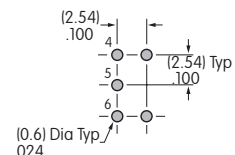

On single pole models positions 1 & 3 are support pins.

### Straight PC



GW22LCP

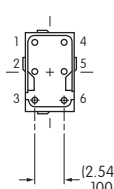
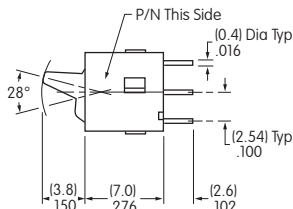
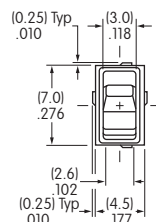

### Double Pole

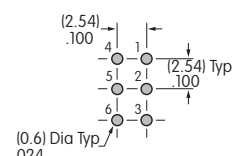



TYPICAL SWITCH DIMENSIONS

Single Pole

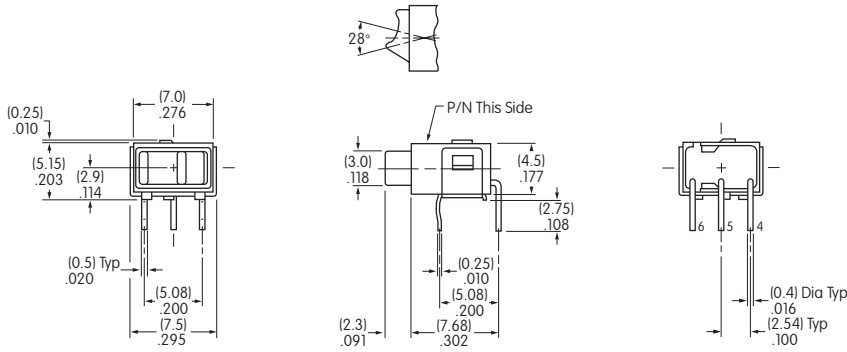

Right Angle PC

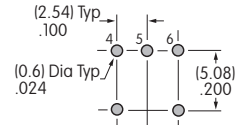

GW12RCH

Double Pole

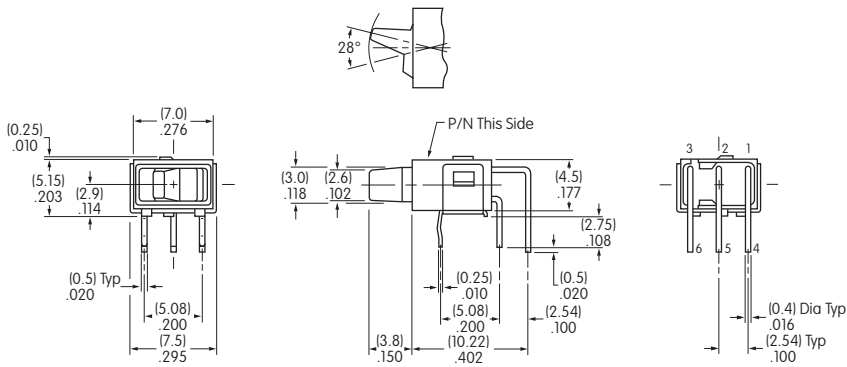

Right Angle PC

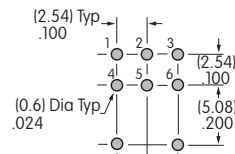

GW22LCH

Single Pole

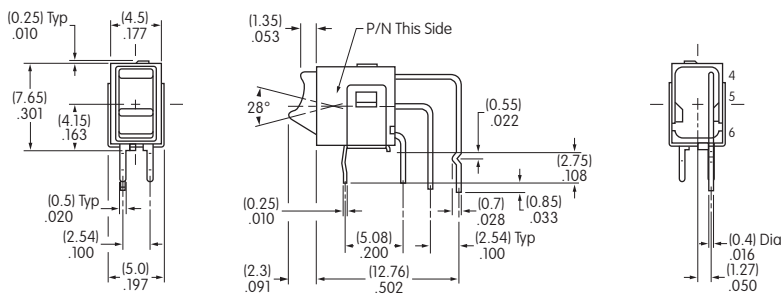

Vertical PC

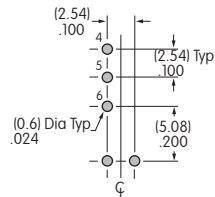

GW12RCV

Double Pole

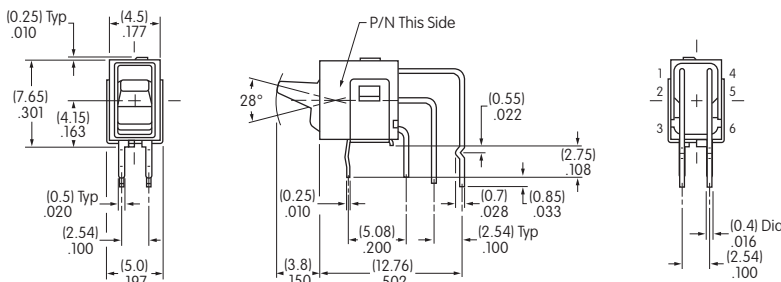

Vertical PC

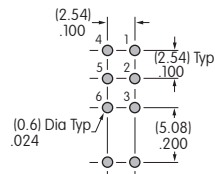

GW22LCV

# General Specifications

Toggles

Rockers

Pushbuttons

Programmable Illuminated PB

Keylocks

Rotaries

Slides

Tactiles

Tilt

Touch

Indicators

Accessories

Supplement

## B Electrical Capacity (Resistive Load)

**Logic Level:** 0.4VA maximum @ 28V AC/DC maximum  
(Applicable Range 0.1mA ~ 0.1A @ 20mV ~ 28V)  
Note: Find additional explanation of operating range in Supplement section.

## Other Ratings

**Contact Resistance:** 80 milliohms maximum  
**Insulation Resistance:** 500 megohms minimum @ 500V DC  
**Dielectric Strength:** 500V AC minimum for 1 minute minimum  
**Mechanical Life:** 50,000 operations minimum  
**Electrical Life:** 50,000 operations minimum  
**Nominal Operating Force:** 1.0N  
**Angle of Throw:** 28°

## Materials & Finishes

**Actuator:** Polycarbonate resin (UL94V-0)  
**Case:** Glass fiber reinforced polyamide (UL94V-0)  
**Sealing Ring:** Nitrile butadiene rubber  
**Base:** Glass fiber reinforced polyamide  
**Movable Contact:** Phosphor bronze with gold plating  
**Stationary Contact:** Phosphor bronze with gold plating  
**Terminals:** Phosphor bronze with gold plating

## Environmental Data

**Operating Temperature Range:** -25°C through +55°C (-13°F through +131°F)  
**Humidity:** 90 ~ 95% humidity for 240 hours @ 40°C (104°F)  
**Vibration:** 10 ~ 55Hz with peak-to-peak amplitude of 1.5mm traversing the frequency range & returning in 5 minutes; 3 right angled directions for 2 hours  
**Shock:** 50G (490m/s<sup>2</sup>) acceleration (tested in 3 right angled directions, with 5 shocks in each direction)

## PCB Processing

**Soldering:** Wave Soldering recommended. See Profile A in Supplement section.  
Manual Soldering: See Profile A in Supplement section.  
**Cleaning:** These devices are not process sealed. Hand clean locally using alcohol based solution.

## Standards & Certifications

**Flammability Standard:** UL94V-0 actuator & case

The GW Series illuminated paddles have not been tested for UL recognition or CSA certification. These switches are designed for use in a low-voltage, low-current, logic-level circuit. When used as intended in a logic-level circuit, the results do not produce hazardous energy.

# Distinctive Characteristics

World's smallest fully illuminated paddles for highly visible status indication; LEDs available in red, green, or amber for single color and red/green for bicolor.

Specially designed switching mechanism provides crisp actuation feedback to positively indicate circuit transfer.

Insert molded terminals prevent entry of flux and other contaminants.

Award-winning STC contact mechanism with benefits unavailable in conventional mechanisms: smoother, positive detent actuation, increased contact stability, and unparalleled logic-level reliability. (Additional STC details in Terms & Acronyms; see Supplement section.)

.100" x .100" (2.54mm x 2.54mm) terminal spacing conforms to standard PC board grid spacing for straight and angle mounting.



Actual Size

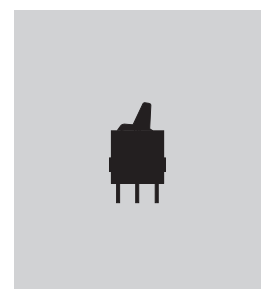

Toggle

**B** Rockers

Pushbuttons

Illuminated PB

Programmable

Keylocks

Rotaries

Slides

Tactiles

Tilt

Touch

Indicators

Accessories

Supplement

### TYPICAL SWITCH ORDERING EXAMPLE

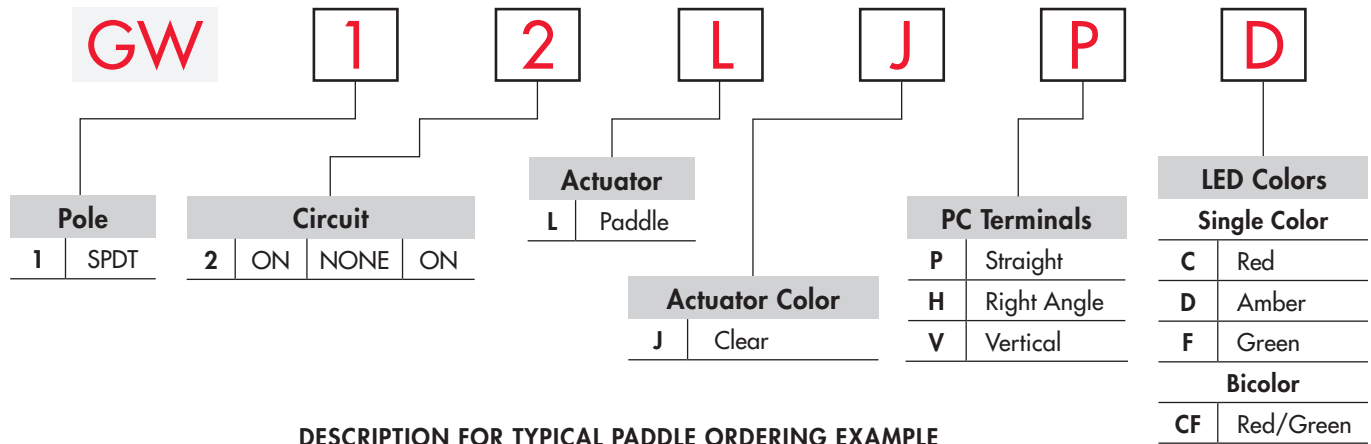

### DESCRIPTION FOR TYPICAL PADDLE ORDERING EXAMPLE

**GW12LJP D**

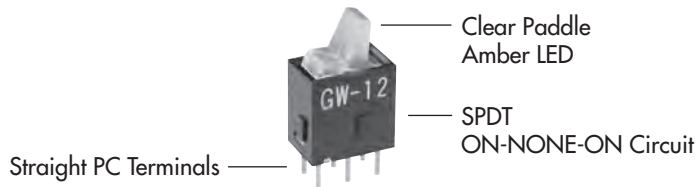

### POLE & CIRCUIT

Pole	Model	Paddle Position			Connected Terminals			Throw & Schematics
		Up	Center	Down	Up	Center	Down	
SP	GW12	ON	NONE	ON	2-3	OPEN	2-1	Note: Terminal numbers are not actually on the switch. LED circuit is isolated and requires an external power source. SPDT  Single Color  Bicolor

### LED COLORS & SPECIFICATIONS

LEDs are an integral part of the the switch and not available separately. The electrical specifications shown are determined at a basic temperature of 25°C. If the source voltage exceeds the rated voltage, a ballast resistor is required. The resistor value can be calculated by using the formula in the Supplement section.

	Colors	Single Color			Bicolor
		C Red	D Amber	F Green	CF Red/Green
Maximum Forward Current	$I_{FM}$	30mA	30mA	25mA	30mA/25mA
Typical Forward Current	$I_F$	20mA	20mA	20mA	20mA/20mA
Forward Voltage	$V_F$	2.0V	2.0V	2.1V	2.0V/2.1V
Maximum Reverse Voltage	$V_{RM}$	5V	5V	5V	5V/5V
Current Reduction Rate Above 25°C	$\Delta I_F$	No Current Reduction Rate within Ambient Temperature Range			
Ambient Temperature Range		-25°C ~ +55°C			

## TYPICAL SWITCH DIMENSIONS

### Straight PC

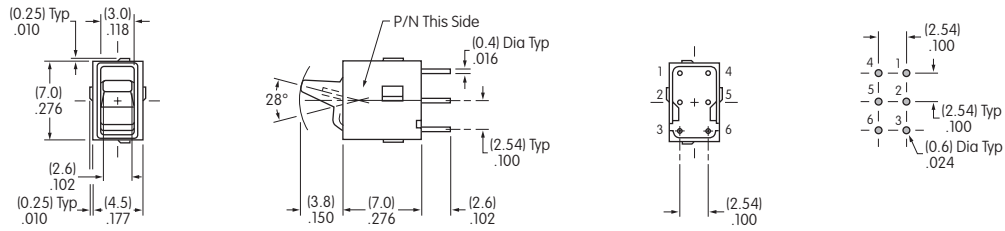

5 & 6 are LED terminals; 4 is a support pin on single color models & an LED terminal on bicolor models.

**GW12LJPC**



### Right Angle PC

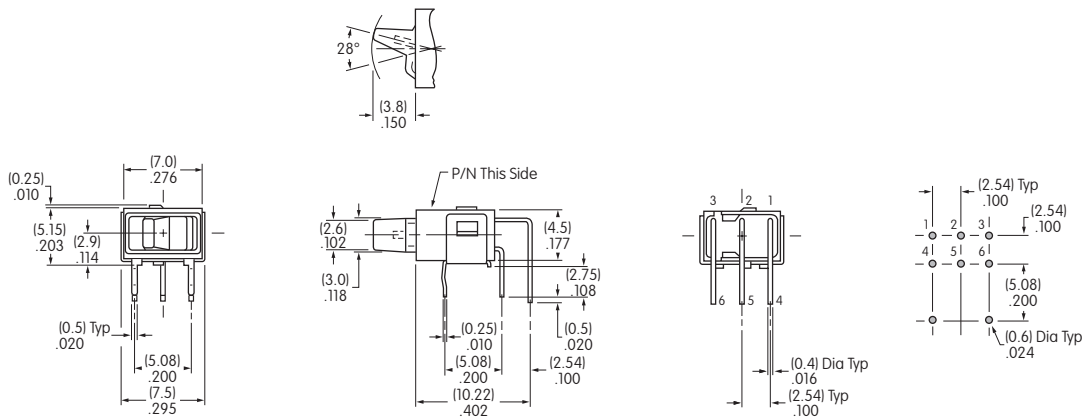

5 & 6 are LED terminals; 4 is a support pin on single color models & an LED terminal on bicolor models.

**GW12LJHD**



### Vertical PC

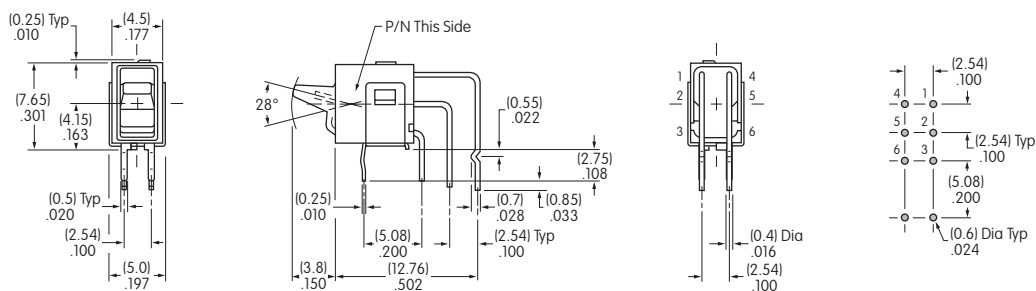

5 & 6 are LED terminals; 4 is a support pin on single color models & an LED terminal on bicolor models.

**GW12LJVCF**



# General Specifications

## Electrical Capacity (Resistive Load)

**Power Level:** 10A @ 125/250V AC for JWM & JWMW models; 10A @ 30V DC for JWMW;  
16A @ 125/250V AC for JWL & JWLW models; 5A @ 72V DC for telecommunication applications

## Other Ratings

**Contact Resistance:** 10 milliohms maximum for JWM & JWMW; 20 milliohms maximum for JWL & JWLW  
**Insulation Resistance:** 1,000 megohms minimum @ 500V DC  
**Dielectric Strength:** 2,000V AC minimum between contacts for 1 minute minimum;  
4,000V AC minimum between contacts & case for 1 minute minimum  
**Mechanical Life:** 25,000 operations minimum  
**Electrical Life:** 25,000 operations minimum  
**Nominal Operating Force:** JWM & JWMW Single Pole 3.92N & Double Pole 7.84N  
JWL Single Pole 5.00N & Double Pole 10.00N; JWLW Double Pole 10.00N  
**Angle of Throw:** 26°

## Materials & Finishes

**Rocker:** Polyphenylene ether (UL94V-0)      **Contacts:** JWM & JWMW: Silver alloy with silver plating  
JWL & JWLW: Silver alloy plus copper with silver plating  
**Housing/Frame & Barrier:** Polyamide (UL94V-0)  
**Interior Seal for JWM & JWL:** Polyphenylene sulfide (UL94V-0)  
**Case/Base:** Melamine (UL94V-0)      **Terminals:** Brass with silver plating

## Environmental Data

**Operating Temperature Range:** -25°C through +70°C (-13°F through +158°F) for JWM & JWL;  
-25°C through +85°C (-13°F through +185°F) for panel seal JWMW & JWLW models  
**Humidity:** 90 ~ 95% humidity for 96 hours @ 40°C (104°F)  
**Vibration:** 10 ~ 55Hz with peak-to-peak amplitude of 1.5mm traversing the frequency range & returning in 1 minute; 3 right angled directions for 2 hours  
**Shock:** 50G (490m/s<sup>2</sup>) acceleration (tested in 6 right angled directions, with 5 shocks in each direction)  
**Sealing:** IP67 of IEC60529 standard for panel seal JWMW & JWLW models; dust resistant inner seal for others

## Installation

**Soldering Time & Temperature:** Manual Soldering: See Profile A in Supplement section.

## Standards & Certifications

**Flammability Standards:** UL94V-0 for rocker, housing, seal & case/base of JWL, JWM, JWMW & JWLW models

**TV Ratings for UL & CSA:** JWM (TV-5) Overload Test @ 120V AC for 50 operations:  
Steady State Current (rms) 7.5A; Minimum Inrush Current (peak) 111A.  
JWM (TV-5) Endurance Test @ 120V AC for 25,000 operations:  
Steady State Current (rms) 5A; Minimum Inrush Current (peak) 78A.  
JWL (TV-8) Overload Test @ 120V AC for 50 operations:  
Steady State Current (rms) 12A; Minimum Inrush Current (peak) 163A.  
JWL (TV-8) Endurance Test @ 120V AC for 25,000 operations:  
Steady State Current (rms) 8A; Minimum Inrush Current (peak) 117A.

**UL:** File No. E44145  
JWM & JWMW models recognized at 10A @ 250V AC.  
JWMW recognized at 10A @ 30V DC.  
JWL & JWLW models recognized at 16A @ 250V AC; JWL at 5A @ 72V DC.

### Models below recognized only when ordered with marking on switch.

JWMW: add "/U" to end of part number to order UL mark on switch; add "/CUL" to end of part number to order cULus mark on switch.

JWL: add "/U-DC" to end of part number to request UL rating on DC rated switch.

**CSA:** File No. 023535\_0\_000  
JWM & JWMW models certified at 10A @ 250V AC; JWL models certified at 16A @ 250V AC

**VDE:** License No. 115674  
JWM models approved at steady state 5A, inrush 80A, resistive 10A, & motor load 6A all at 250V AC; JWL models approved at steady state inrush 128A, resistive 16A, & motor load 8A all at 250V AC.

Note: JWM & JWL Double Pole, Single Throw models approved only with the international ON-OFF symbols on the actuator.

## Distinctive Characteristics

Industry's first molded rocker with TV rating. Designed to handle large inrush current, with high electrical capacity of 10 and 16 Amps. JWM models certified for TV-5 rating and JWL models for TV-8 rating.

JWMW and JWLW panel seal versions meet IP67 of IEC60529 Standards (similar to NEMA 4 and 6).

Prominent external insulating barriers increase insulation resistance and dielectric strength.

Uniquely constructed to break light contact welds.

Increased electrical life with specially designed plate to minimize contact bounce.

Constructed for dust resistance with interior cover between actuator and contact area.

Terminals are molded in and epoxy sealed to lock out flux, dust, and other contaminants.

Solder lug/quick connect terminals can be used with connector.

Housing and case of heat resistant resin meet UL94V-0 standard.

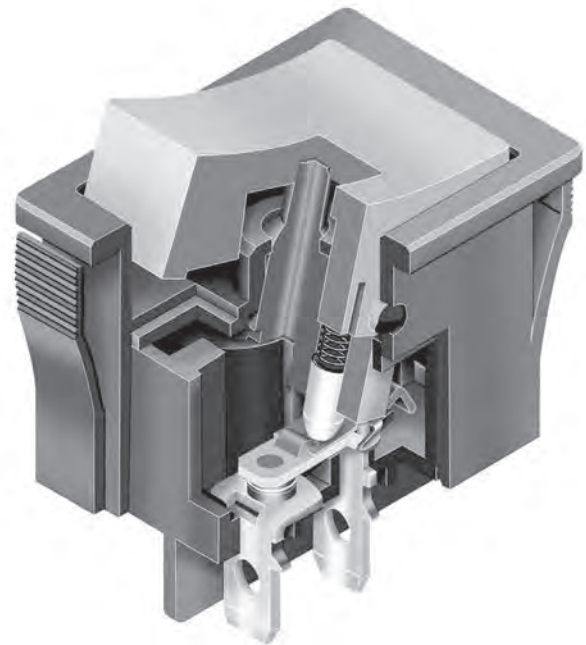

Actual Size JWM



Toggles

**B** Rockers

Pushbuttons

Illuminated PB

Programmable

Key locks

Rotaries

Slides

Tactiles

Tilt

Touch

Indicators

Accessories

Supplement

### TYPICAL SWITCH ORDERING EXAMPLE

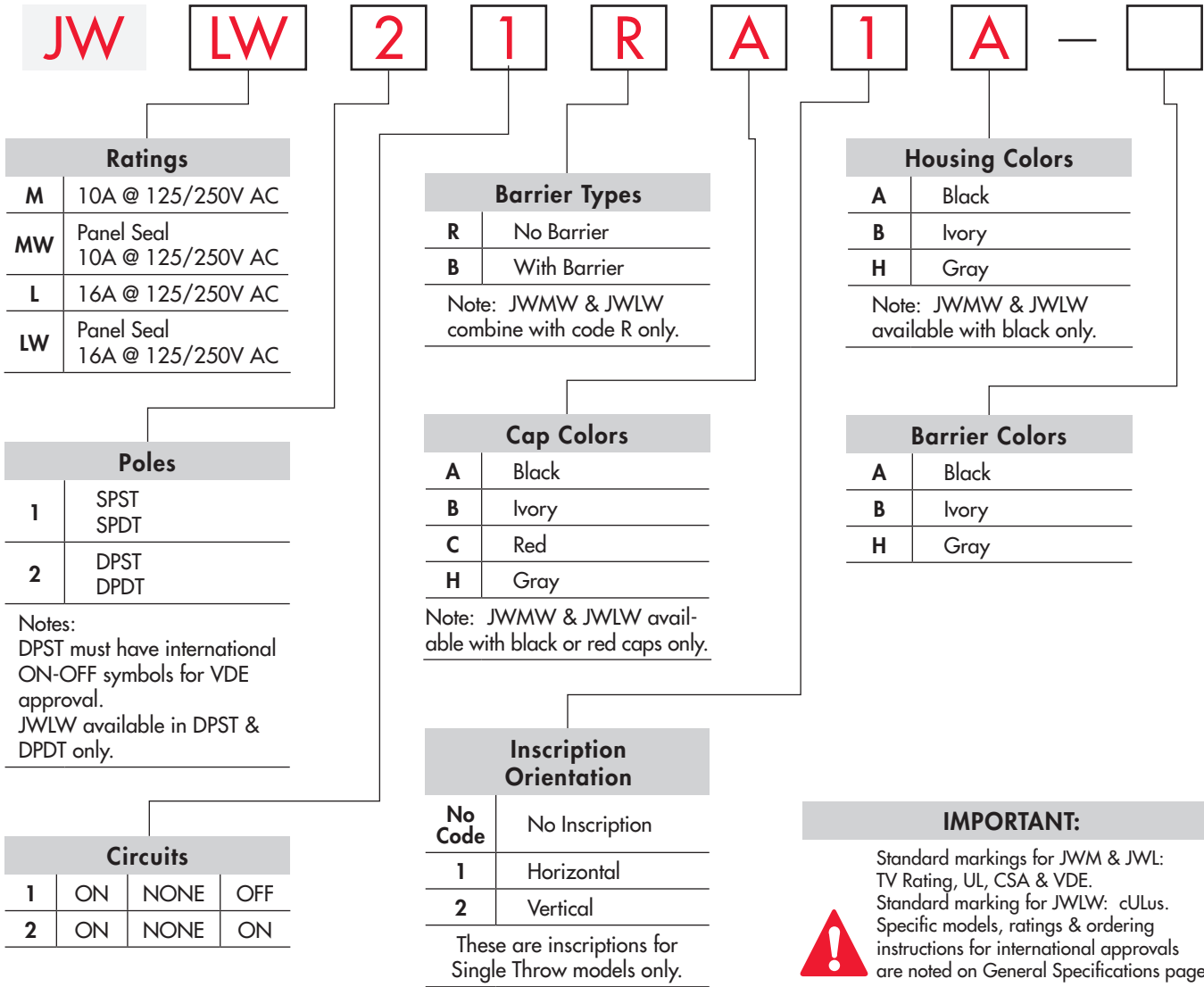

### DESCRIPTION FOR TYPICAL ORDERING EXAMPLE

#### JWLW21RA1A

Black Rocker Cap with International ON-OFF Symbols in Horizontal Orientation



Black Housing

DPST ON-NONE-OFF Circuit

16A @ 125/250V AC



## RATINGS

<b>M</b> Power Level 10A @ 125/250V AC	<b>MW</b> Panel Seal Power Level 10A @ 125/250V AC
<b>L</b> Power Level 16A @ 125/250V AC	<b>LW</b> Panel Seal Power Level 16A @ 125/250V AC

## POLES & CIRCUITS

Pole	Model	Rocker Position			Connected Terminals			Throw & Schematics
		Down	Center	Up	Down	Center	Up	
SP	JWM11 JWMW11 JWL11	ON	NONE	OFF	1-1b	OPEN	OPEN	SPST 
SP	JWM12 JWMW12 JWL12	ON	NONE	ON	1-1b	OPEN	1-1a	SPDT 
DP	JWM21 JWMW21 JWL21 JWLW21	ON	NONE	OFF	1-1b 2-2b	OPEN	OPEN	DPST 
DP	JWM22 JWMW22 JWL22 JWLW22	ON	NONE	ON	1-1b 2-2b	OPEN	1-1a 2-2a	DPDT 

## BARRIER TYPES & COLORS

**R** No Barrier



JWM



JWL

**B** With Barrier



JWM



JWL

No-barrier type has a flat flange which is an integral part of the switch.

JWMW and JWLW panel seal devices have exterior seal of acrylonitrile butadiene rubber covering the flange.

Flange/Housing Material: Polyamide

Finish: Matte

Barrier type designates that either AT217 (for JWM) or AT218 (for JWL) is factory assembled. Dimensions for barriers are shown in the Accessories section.

**Barrier Colors Available:**

**A** Black

Black

**B** Ivory

Ivory

**H** Gray

Gray

Barrier Material: Polyamide

Finish: Matte

## CAP COLORS



**Cap Colors Available:**

**A** Black

Black

**B** Ivory

Ivory

**C** Red

Red

**H** Gray

Gray

Cap Material: Polyphenylene Oxide

Finish: Matte

Rocker cap is an integral part of the switch and not available separately.

JWMW and JWLW available with black or red caps only.

### INSCRIPTIONS

**No Code**

No Inscription



**1**

Inscription for Horizontal Mounting



**2**

Inscription for Vertical Mounting



DPST models without inscriptions do not have VDE approval.

The IEC symbols for On-Off are supplied with Single Throw models only. Orientation of inscription must be selected. Inscription Colors: Black ink on Ivory or Gray cap. White ink on Black or Red cap. Contact factory for other inscriptions.

### HOUSING

Material: Polyamide

Colors Available:

**A** Black

**B** Ivory

**H** Gray

Finish: Matte

JWMW and JWLW panel seal models available with black housing only.

### TERMINALS

Solder Lug/Quick Connect .110" (2.8mm)

Solder Lug/Quick Connect .187" (4.75mm)

JWM & JWMW

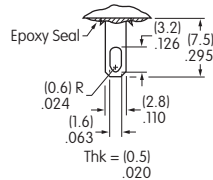

JWL & JWLW

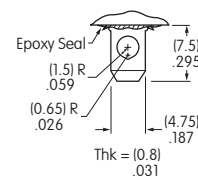

### PANEL CUTOUTS

#### Panel Thickness Range

Without Barrier (JWM & JWMW):  
.039" ~ .157" (1.0mm ~ 4.0mm)

With Barrier (JWM):  
.024" ~ .126" (0.6mm ~ 3.2mm)

JWM

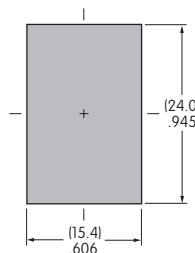

JWMW

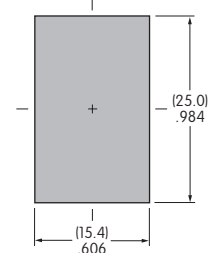

#### Panel Thickness Range

Without Barrier (JWL & JWLW):  
.039" ~ .157" (1.0mm ~ 4.0mm)

With Barrier (JWL):  
.024" ~ .126" (0.6mm ~ 3.2mm)

JWL

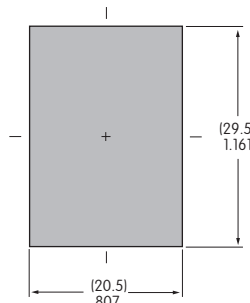

JWLW

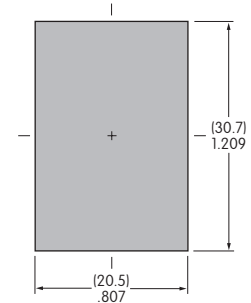

## TYPICAL SWITCH DIMENSIONS FOR JWM & JMW

### Single & Double Pole

### No Barrier • 10 Amp

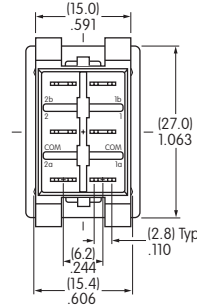
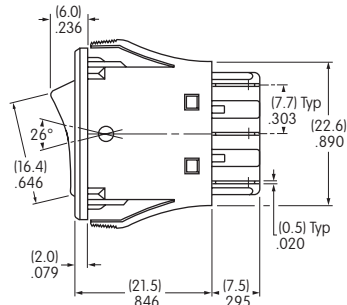
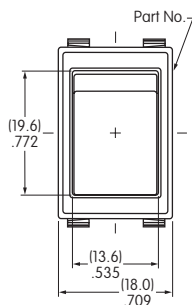

**JWM11RC1A**

### Single & Double Pole

### With Barrier • 10 Amp

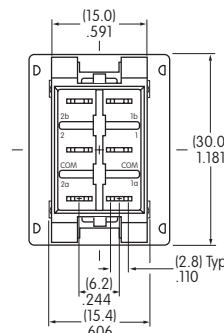
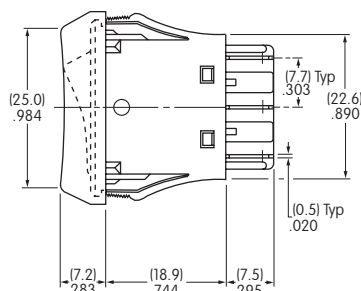
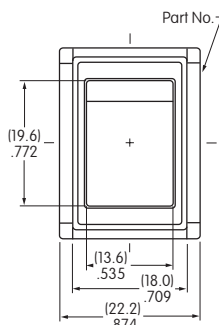

**JWM11BCA-H**

### Single & Double Pole

### Panel Seal • No Barrier • 10 Amp

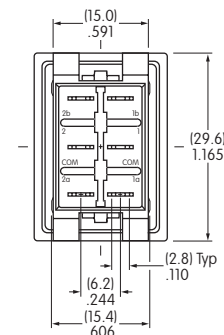
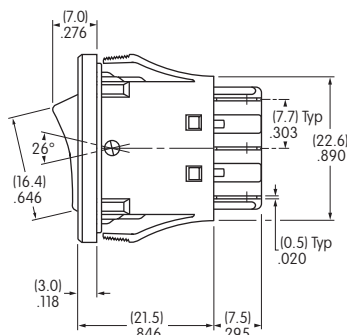
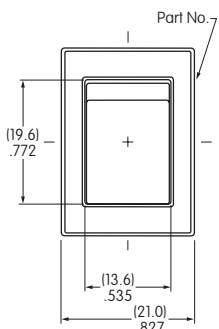

**JWMW22RCA**

Single pole double throw models do not have terminals 2a, 2, & 2b; single throw models do not have 1a & 2a.

## TYPICAL SWITCH DIMENSIONS FOR JWL & JWLW

### No Barrier • 16 Amp

### Single & Double Pole

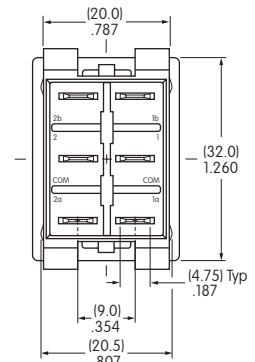
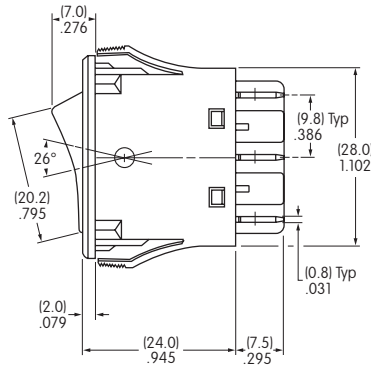
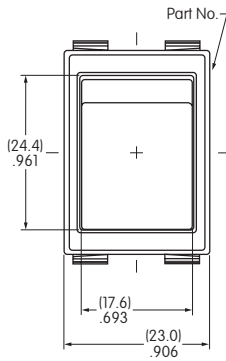

**JWL21RC2A**

Single pole double throw models do not have terminals 2a, 2, & 2b; single throw models do not have 1a & 2a.

### With Barrier • 16 Amp

### Single & Double Pole

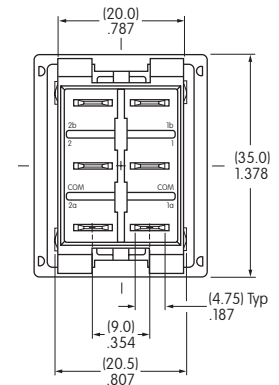
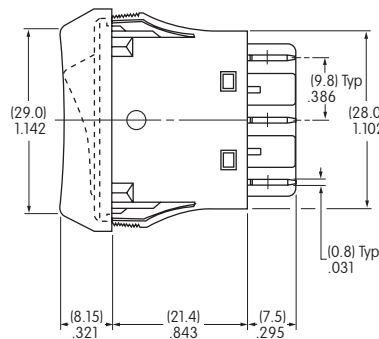
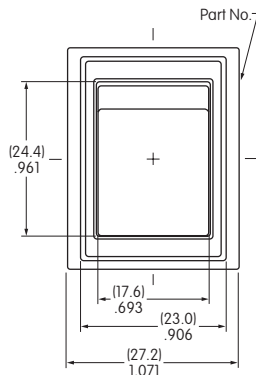

**JWL11BCA-H**

Single pole double throw models do not have terminals 2a, 2, & 2b; single throw models do not have 1a & 2a.

### Panel Seal • 16 Amp • Inscription

### Double Pole Single Throw

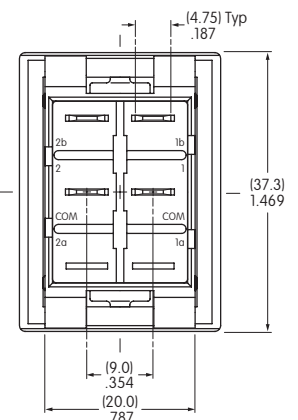
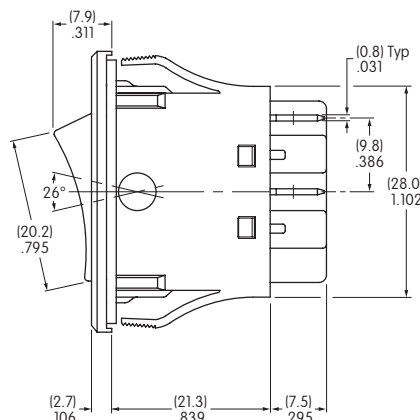
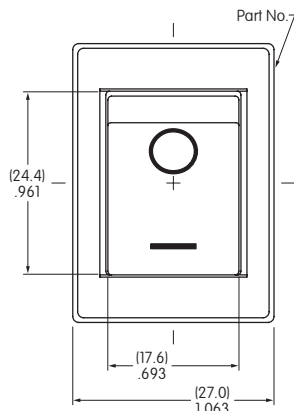

**JWLW21RA1A**

Toggles

Rockers **B**

Pushbuttons

Illuminated PB

Programmable

Keylocks

Rotaries

Slides

Tactiles

Tilt

Touch

Indicators

Accessories

Supplement

## TYPICAL SWITCH DIMENSIONS FOR JWLW

### Double Pole Double Throw

### Panel Seal • 16 Amp • No Inscription

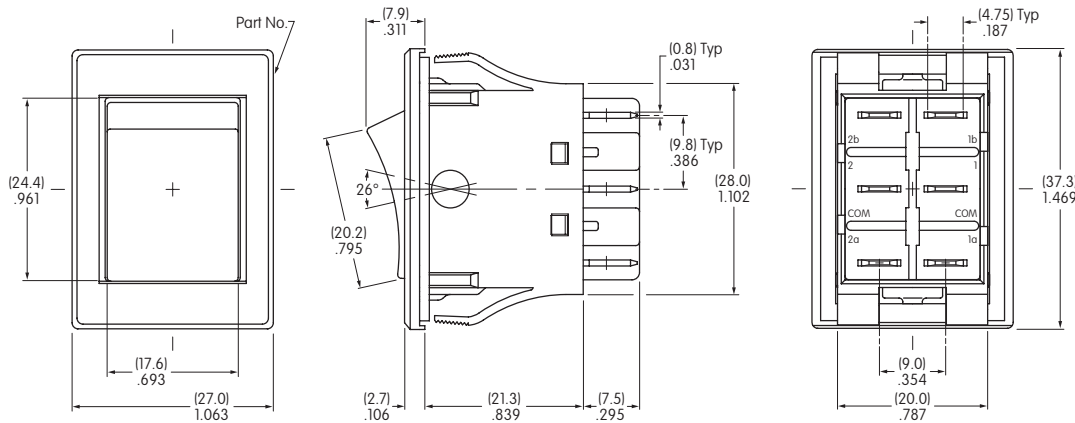

JWLW22RAA

## OPTIONAL DUST COVER

### AT4126

### Dust Cover for JWL Rocker

When installed, the Dust Cover protects the switch from an environment containing small particles and dust. The switch is operable with the Dust Cover in place.

#### Materials:

Lid: Clear Polyvinyl Chloride  
Base: Black Polyamide

#### Recommended Temperature Range:

-10° ~ +70°C (+14°F ~ +158°F)  
Loses pliability below 0°C (+32°F)

#### Recommended Panel Thickness:

.031" ~ .134" (0.8mm ~ 3.4mm)

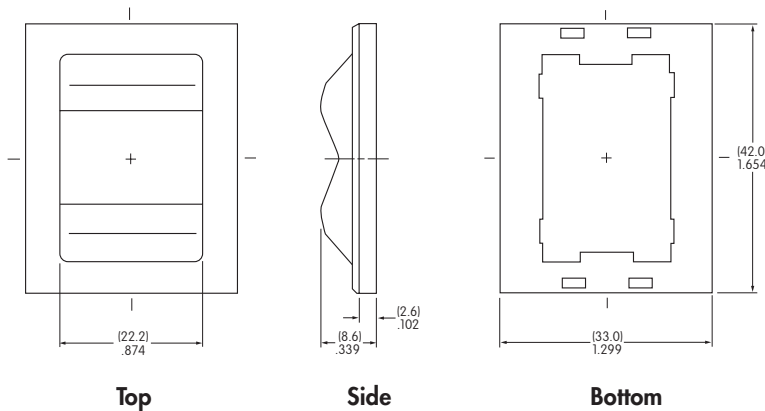
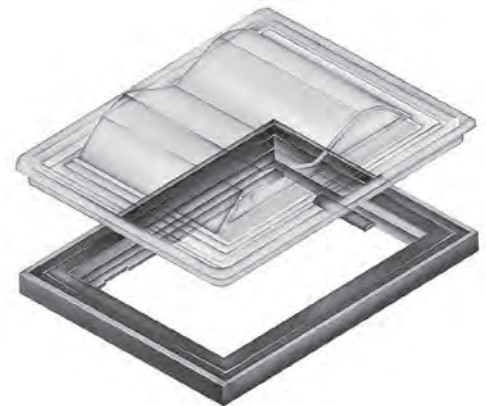

#### Assembly Instructions:

1. Insert bottom of switch through the **base** until the tabs lock into place.
2. Snap the switch into the panel.
3. Seat the **lid** into the **grooves** of the **base**.

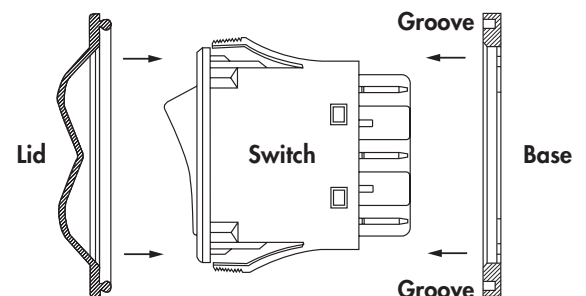

#### Notes

1. The dust cover is not for use with JWLW.
2. The dust cover cannot be used with the barrier option.

### PRECAUTIONS FOR HANDLING & STORAGE FOR JMW/LW (PANEL SEAL TYPES)

#### Operating Environment

- Do not install switch where heavy dust collection occurs. Dust build-up under rocker may affect switch actuation.
- Do not actuate switch if submerged in water or oil.
- Installation is not recommended on horizontal surface in an environment where frequent splashing of water may occur. In such an environment, a minimum 30° angle installation is advisable. If there is a possibility of freezing, install vertically so no moisture will be retained within switch housing.

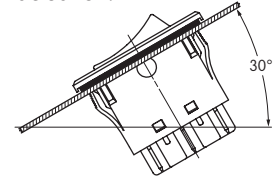

#### Panel Mounting

- Before snapping a switch into the panel, align the gasket evenly under bezel of the switch.
- When mounting into a panel, apply equal pressure to sides of bezel and insert parallel to panel.
- After mounting a switch, be sure there are no gaps between switch and panel. Lightly push into panel.
- After installing into panel, do not apply excessive force.
- After panel installation and wiring is completed, do not apply force horizontally or vertically from behind panel.
- Behind the panel, cut area should be squared. If front of panel is painted, do not allow any paint to collect in corners of cutout to prevent level mounting.
- Avoid reinstalling a switch once it has been mounted in a panel. This may cause deterioration of panel sealability.

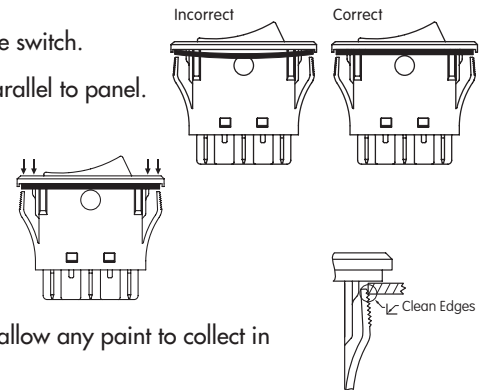



# General Specifications

Toggles

Rockers  
B

Pushbuttons

Illuminated PB

Programmable

Keylocks

Rotaries

Slides

Tactiles

Tilt

Touch

Indicators

Accessories

Supplement

## Electrical Capacity (Resistive Load)

<b>Power Level:</b>	10A @ 125/250V AC
	6A @ 125/250V AC (UL/CSA)
	5A (3A) @ 125/250V AC (VDE)

## Other Ratings

<b>Contact Resistance:</b>	10 milliohms maximum
<b>Insulation Resistance:</b>	500 megohms minimum @ 500V DC
<b>Dielectric Strength:</b>	2,000V AC minimum between contacts for 1 minute minimum; 4,000V AC minimum between contacts & case for 1 minute minimum
<b>Mechanical Life:</b>	30,000 operations minimum
<b>Electrical Life:</b>	10,000 operations minimum
<b>Nominal Operating Force:</b>	Single Pole 3.92N & Double Pole 5.39N
<b>Angle of Throw:</b>	30°

## Materials & Finishes

<b>Rocker:</b>	Polyamide (UL94V-0)
<b>Housing/Case:</b>	Polyamide (UL94V-0)
<b>Movable Contact:</b>	Copper with silver plating
<b>Movable Contacts:</b>	Silver alloy
<b>Stationary Contacts:</b>	Silver alloy
<b>End Terminals:</b>	Brass with silver plating
<b>Common Terminals:</b>	Copper with silver plating
<b>Lamp Terminals:</b>	Phosphor bronze with tin plating (illuminated models only)

## Environmental Data

<b>Operating Temp Range:</b>	-25°C through +70°C (-13°F through +158°F) for nonilluminated models; -25°C through +50°C (-13°F through +122°F) for illuminated models
<b>Humidity:</b>	90 ~ 95% humidity for 96 hours @ 40°C (104°F)
<b>Vibration:</b>	10 ~ 55Hz with peak-to-peak amplitude of 1.5mm traversing the frequency range & returning in 15 minutes; 3 right angled directions for 2 hours
<b>Shock:</b>	50G (490m/s <sup>2</sup> ) acceleration (tested in 6 right angled directions, with 5 shocks in each direction)
<b>Sealing:</b>	Dust resistant inner seal

## Installation

<b>Soldering:</b>	Manual Soldering: See Profile A in Supplement section.
<b>Cleaning:</b>	These devices are not process sealed. Hand cleaning locally using alcohol based solution.

## Standards & Certifications

<b>Flammability Standards:</b>	UL94V-0 for rocker & housing/case
<b>UL:</b>	File No. E44145 All JWS models recognized at 6A @ 125/250V AC
<b>CSA:</b>	File No. 023535_0_000 All JWS models certified at 6A @ 125/250V AC
<b>VDE:</b>	License No. 119153 All JWS models approved at 5A (3A) @ 125/250V AC



# Distinctive Characteristics

Rocker caps and housing available in a variety of colors.

Protective barrier available to prevent accidental actuation.

Constructed for dust resistance with interior cover of polyamide between actuator and contact area.

Easy, crisp actuation.

Small size well suited for telecommunication, measuring, automation, and consumer applications.

Terminals are molded in to lock out flux, dust, and other contaminants.

Outer case of heat resistant resin meets UL94V-0 flammability standard.

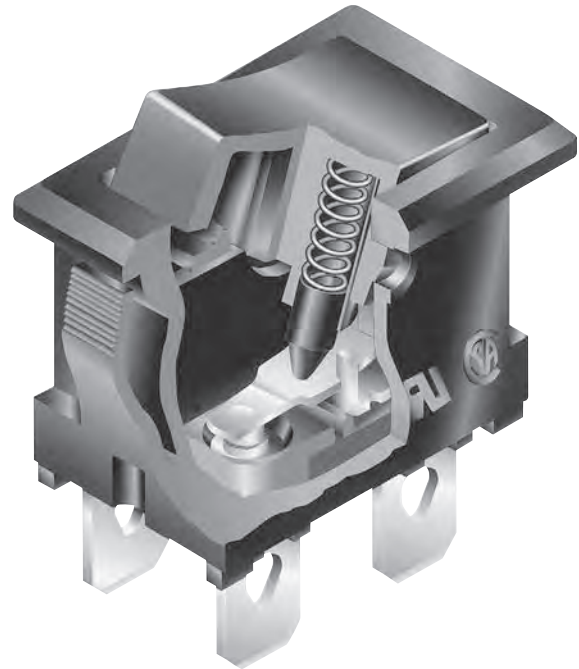

Actual Size

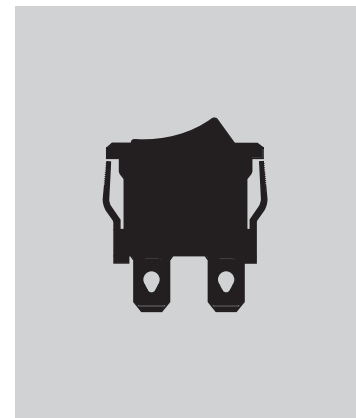

Toggle

**B** Rockers

Pushbuttons

Illuminated PB

Programmable

Key locks

Rotaries

Slides

Tactiles

Tilt

Touch

Indicators

Accessories

Supplement

### TYPICAL SWITCH ORDERING EXAMPLE

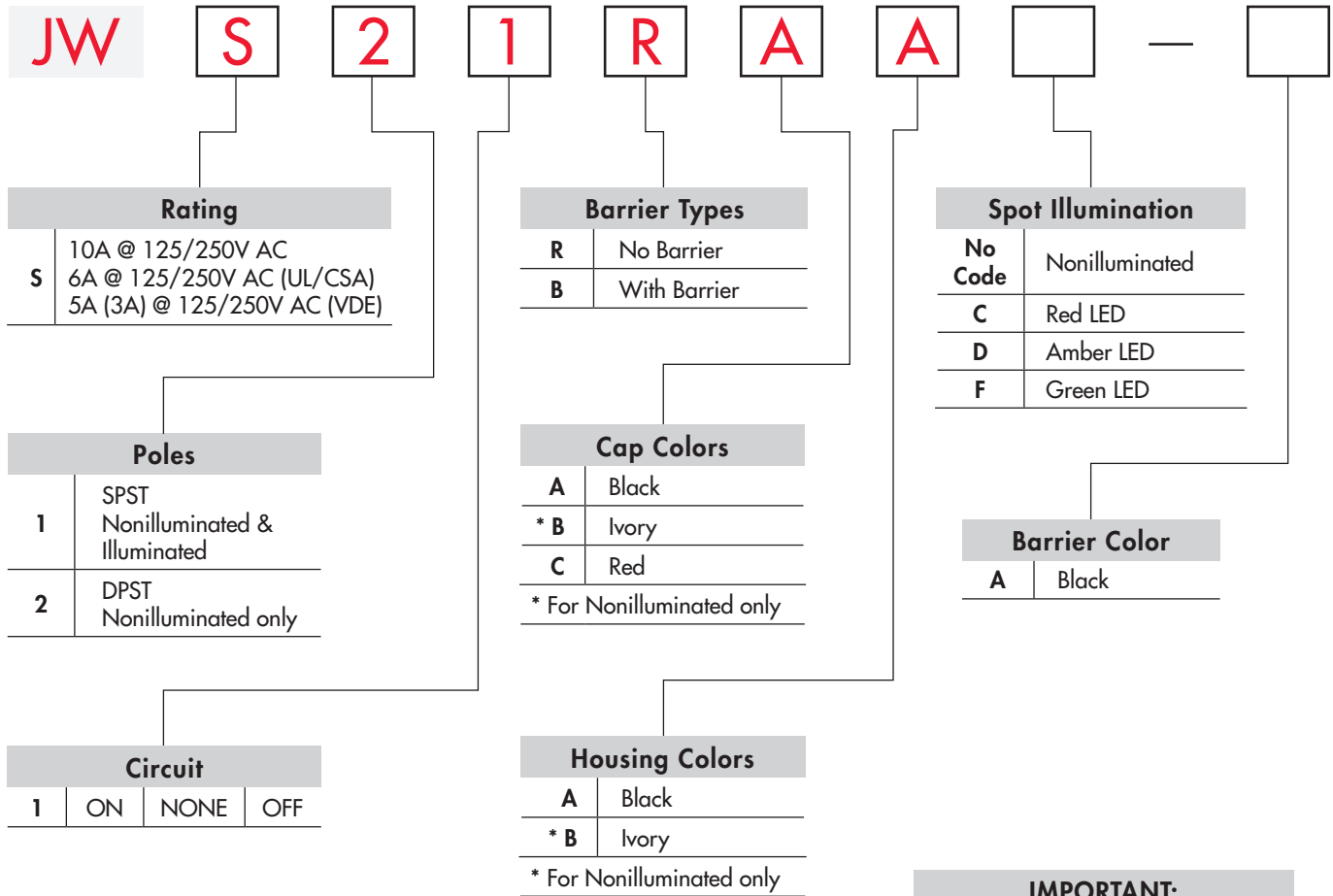

#### IMPORTANT:



cULus & VDE markings are standard on all models. Models & specific ratings are noted on General Specifications page.

#### DESCRIPTION FOR TYPICAL ORDERING EXAMPLE

**JWS21RAA**





Toggles  
Rockers  
Pushbuttons  
Illuminated PB  
Programmable  
Keylocks  
Rotaries  
Slides  
Tactiles  
Tilt  
Touch  
Indicators  
Accessories  
Supplement

## RATING

<b>S</b>	<b>Power Level</b>	10A @ 125/250V AC	6A @ 125/250V AC (UL/CSA)	5A (3A) @ 125/250V AC (VDE)
----------	--------------------	-------------------	---------------------------	-----------------------------

## POLES & CIRCUITS

Pole	Model	Rocker Position			Connected Terminals			Throw & Schematics
		Down	Center	Up	Down	Center	Up	
SP	JWS11	ON	NONE	OFF	2-3	OPEN	OPEN	SPST 
DP	JWS21	ON	NONE	OFF	1-3 4-6	OPEN	OPEN	DPST 

## BARRIER TYPES & COLORS

### **R** No Barrier

No-barrier type has a flat flange which is an integral part of the switch.



### **B** With Barrier

Barrier Material: Polyamide  
Finish: Matte

Barrier AT219 is factory assembled.  
Dimensions for barrier are shown in the Accessories section.



Barrier Color Available: **A** Black

## CAP COLORS



Cap Material: Polyamide

Finish: Matte

Rocker cap is an integral part of the switch and not available separately.  
\* Ivory for nonilluminated models only.

Cap Colors Available:

**A** Black

**B** \* Ivory

**C** Red

## HOUSING

Material: Polyamide  
Finish: Matte

Colors Available:

**A** Black

**B** Ivory (for nonilluminated models only)

## TERMINALS

### Solder Lug/.187" (4.75mm) Quick Connect

Switch assembly with connectors is not UL, CSA, C-UL, or VDE approved.

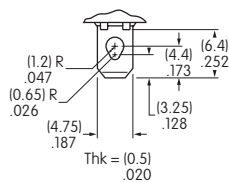

Switch

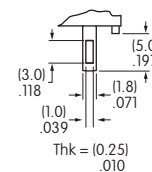

Lamp  
(spot illuminated models only)

### LED COLORS & SPECIFICATIONS FOR SPOT ILLUMINATED MODELS

LEDs are supplied as an integral part of illuminated devices and are not available separately. LED polarity markings are on the bottom of the switch.

The electrical specifications shown here are determined at a basic temperature of 25°C.

If the source voltage exceeds the rated voltage, a ballast resistor is required. The resistor value can be calculated by using the formula in the Supplement section.

		<b>C</b>	<b>D</b>	<b>F</b>
				
	Color	Red	Amber	Green
Maximum Forward Current	$I_{FM}$	30mA	20mA	30mA
Typical Forward Current	$I_F$	10mA	10mA	10mA
Forward Voltage	$V_F$	1.8V	2.0V	2.1V
Maximum Reverse Voltage	$V_{RM}$	5V	5V	5V
Current Reduction Rate Above 25°C	$\Delta I_F$	No Current Reduction Rate Within Specified Operating Temperature		
Ambient Temperature Range		-25°C ~ +50°C		

### PANEL CUTOUT & PANEL THICKNESS RANGES

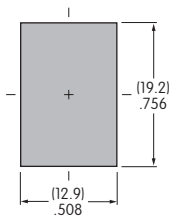

#### Panel Thickness Ranges:

Without Barrier:  
.030" ~ .079" (0.75mm ~ 2.0mm)

With Barrier:  
.024" ~ .059" (0.6mm ~ 1.5mm)

### TYPICAL SWITCH DIMENSIONS

#### Nonilluminated • No Barrier

#### Single Pole

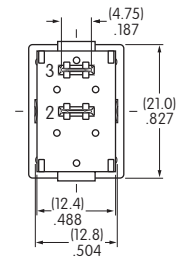
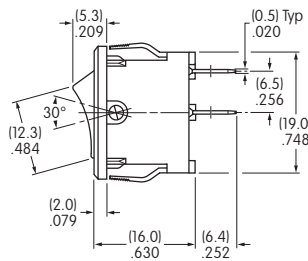
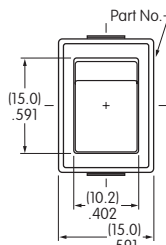

**JWS11RCA**

#### Nonilluminated • No Barrier

#### Double Pole

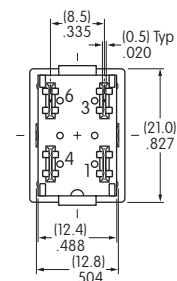
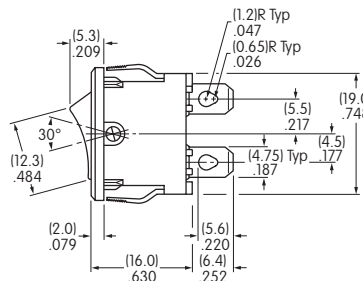
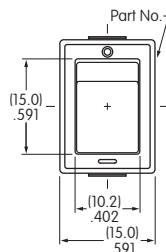

**JWS21RAA**

DPST models have IEC symbols for On-Off on the flange.

TYPICAL SWITCH DIMENSIONS

Single Pole

Nonilluminated • With Barrier

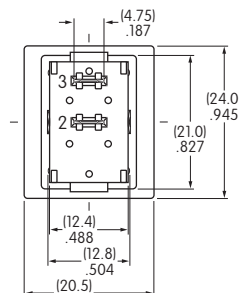
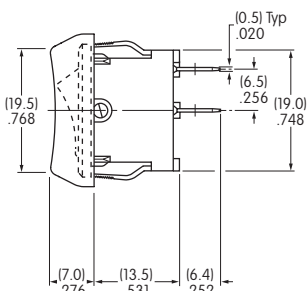
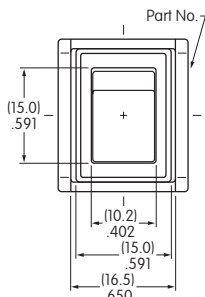

JWS11BBA-A

Double Pole

Nonilluminated • With Barrier

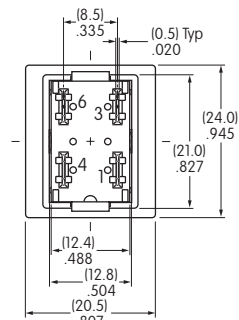
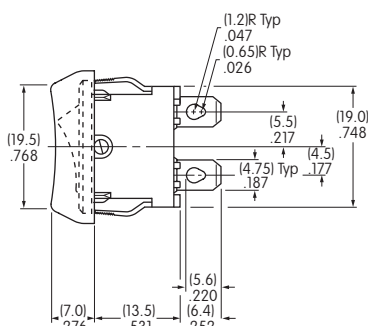
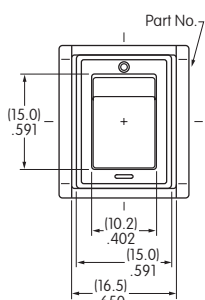

JWS21BAA-A

DPST models have IEC symbols for On-Off on the flange.

Single Pole

Spot Illuminated • No Barrier

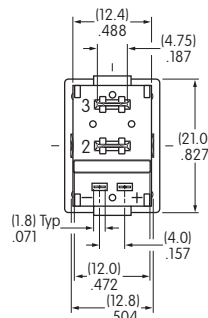
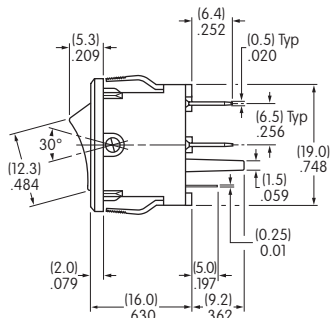
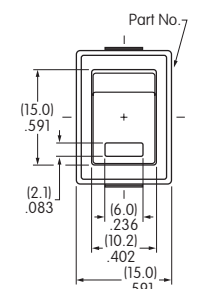

JWS11RCAF

Single Pole

Spot Illuminated • With Barrier

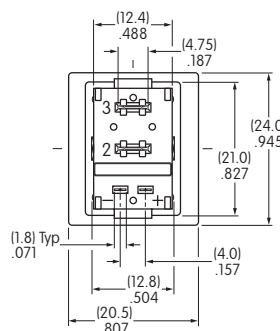
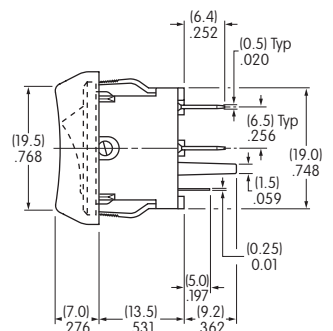
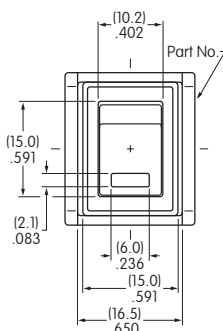

JWS11BAAF-A

- Toggle
- B** Rockers
- Pushbuttons
- Illuminated PB
- Programmable
- Key locks
- Rotaries
- Slides
- Tactiles
- Tilt
- Touch
- Indicators
- Accessories
- Supplement

# General Specifications

Toggles

Rockers

Pushbuttons

Illuminated PB

Programmable

Keylocks

Rotaries

Slides

Tactiles

Tilt

Touch

Indicators

Accessories

Supplement

## B Electrical Capacity

**Resistive Load:** 10A @ 125V AC, 6A @ 250V AC, or 6A @ 30V DC

**Inductive Load:** 5A @ 125V AC (P. F. @ .60)

## Other Ratings

**Contact Resistance:** 10 milliohms maximum

**Insulation Resistance:** 200 megohms minimum @ 500V DC

**Dielectric Strength:** 1,500V AC minimum for 1 minute minimum

**Mechanical Life:** 30,000 operations minimum

**Electrical Life:** 10,000 operations minimum

**Nominal Operating Force:** 11.77N for maintained & 17.65N for momentary

**Angle of Throw:** 34°

## Materials & Finishes

**Housing:** Steel with chrome plating

**Movable Contacts:** Silver clad copper with silver plating

**Stationary Contacts:** Copper with silver plating

**Base:** Melamine

**Common Terminal:** Copper with tin plating

**End Terminals:** Brass with tin plating

**Lamp Terminals:** Phosphor bronze with nickel plating

## Environmental Data

**Operating Temperature Range:** -20°C through +50°C (-4°F through +122°F)

**Humidity:** 90 ~ 95% humidity for 96 hours @ 40°C (104°F)

**Vibration:** 10 ~ 55Hz with peak-to-peak amplitude of 1.5mm traversing the frequency range & returning in 1 minute; 3 right angled directions for 2 hours

**Shock:** 50G (490m/s<sup>2</sup>) acceleration (tested in 3 right angled directions, with 3 shocks in each direction)

## Installation

**Cap Installation Force:** 19.61N (4.41 lbf)

**Soldering Time & Temperature:** Manual Soldering: See Profile A in Supplement section.

## Standards & Certifications

**UL:** File No. E44145 - Recognized only when ordered with marking on switch.  
Add "/U" or "/CUL" before first dash in part number to order UL recognized switch.  
All models recognized at 10A @ 125V AC & 6A @ 250V AC

# Distinctive Characteristics

Each half of the rocker face is distinctly illuminated due to partitioned rocker construction and dual lamps.

Numerous lighting effects achievable by using white or clear rocker with colored filters or lamp covers, plus using different colors on each side of rocker.

Snap-in mounting allows fast, easy installation of switch into panel.

Stainless steel retaining clips provide secure mounting over a wide range of panel thicknesses.

Dual incandescent or neon lamps operate independently of each other.

Front panel relamping.

Stationary lamp sockets are independent of rocker actuation, protecting lamps from damage due to shock and vibration.

Switch contacts are rated at 10 amps 125V AC which makes these devices well-suited for various power switching applications.

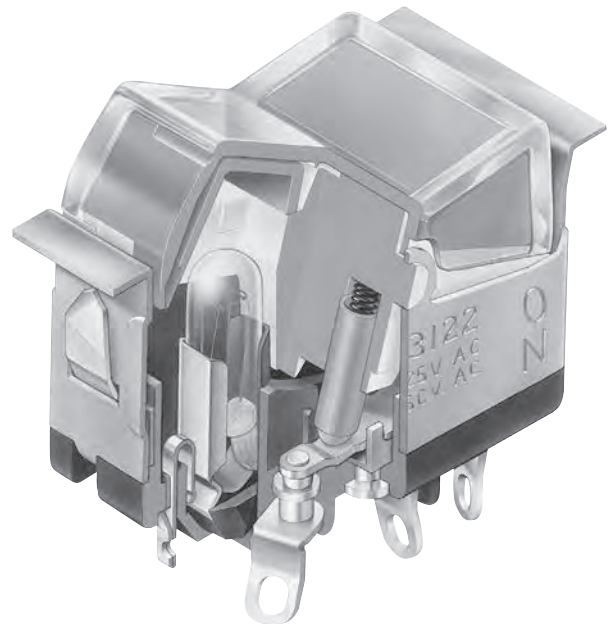

Actual Size

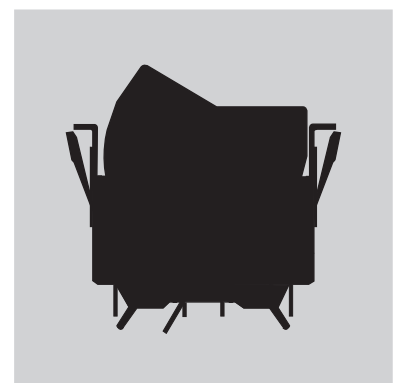

Supplement	Accessories	Indicators	Touch	Tilt	Tactiles	Slides	Rotaries	Key locks	Programmable	Illuminated PB	Pushbuttons	Rockers	Toggle
------------	-------------	------------	-------	------	----------	--------	----------	-----------	--------------	----------------	-------------	---------	--------

### TYPICAL SWITCH ORDERING EXAMPLE

**LW31**

**2**

**2**

**H**

**4**

**C**

**F**

**A**

#### Pole

**2** DPDT

#### Circuits

	Up	Center	Down
<b>2</b>	ON	NONE	ON
<b>3</b>	ON	OFF	ON
<b>5</b>	ON	NONE	(ON)
<b>8</b>	(ON)	OFF	(ON)
<b>9</b>	ON	OFF	(ON)

( ) = Momentary

#### Lamps

##### Incandescent

<b>E</b>	6-volt
<b>F</b>	12-volt
<b>H</b>	18-volt
<b>K</b>	24-volt
<b>L</b>	28-volt

##### Neon

<b>N</b>	110-volt
----------	----------

Not suitable with green & blue

##### Nonilluminated

<b>0</b>	No Lamp
----------	---------

#### Rocker Caps

<b>1</b>	White without filters or lamp covers
<b>2</b>	White with filters
<b>3</b>	White with lamp covers
<b>4</b>	Clear with filters

#### Lamp Cover/Filter Colors For Up Position

<b>0</b>	No Cover/Filter
<b>Lamp Cover</b>	
<b>C</b>	Red
<b>D</b>	Amber
<b>F</b>	Green
<b>Filter</b>	
<b>B</b>	White
<b>C</b>	Red
<b>D</b>	Amber
<b>E</b>	Yellow
<b>F</b>	Green
<b>G</b>	Blue

#### Lamp Cover/Filter Colors For Down Position

<b>0</b>	No Cover/Filter
<b>Lamp Cover</b>	
<b>C</b>	Red
<b>D</b>	Amber
<b>F</b>	Green
<b>Filter</b>	
<b>B</b>	White
<b>C</b>	Red
<b>D</b>	Amber
<b>E</b>	Yellow
<b>F</b>	Green
<b>G</b>	Blue

#### Bezel

<b>No Code</b>	No Bezel
<b>A</b>	Black
<b>B</b>	White
<b>C</b>	Red
<b>D</b>	Amber
<b>E</b>	Yellow
<b>F</b>	Green
<b>G</b>	Blue
<b>H</b>	Gray

### IMPORTANT:



Switches are supplied without UL & cULus marking unless specified. **UL & cULus recognized only when ordered with marking on the switch.** Specific models, ratings, & ordering instructions are noted on General Specifications page.

### DESCRIPTION FOR TYPICAL ORDERING EXAMPLE

**LW3122-H4CF-A**

Clear Rocker with Red Filter in Up Position & Green Filter in Down Position

DPDT ON-NONE-ON Circuit



18-volt Incandescent Lamp

Black Bezel



## POLES & CIRCUITS

Pole	Model	Rocker Position ( ) = Momentary			Connected Terminals			Throw & Power/Lamp Schematics
		Up	Center	Down	Up	Center	Down	
DP	LW3122 LW3123 LW3125 LW3128 LW3129	ON ON ON (ON) ON	NONE OFF NONE OFF OFF	ON ON (ON) (ON) (ON)	2-3	5-6	OPEN	2-1 5-4

Notes: Terminal numbers are not actually on switch. Lamp circuit is isolated and requires an external power source.

DPDT

## LAMP CODES & SPECIFICATIONS

Electrical specifications are determined at a basic temperature of 25°C. Lamp circuit is independent of switch operation.

For dimension drawing of lamps see Accessories & Hardware section.

For neon, if the source voltage is greater than rated voltage, a ballast resistor is required. The ballast resistor calculation and more lamp detail are shown in the Supplement section. Neon not for use with green lamp cover or blue and green filters.

### Incandescent & Neon Lamps for Solid & Design Caps

AT602 Incandescent	AT602N Neon	Voltage	V	E	F	H	K	L	N
				6V AC	12V AC	18V AC	24V AC	28V AC	110V AC
Current	I	80mA	50mA	35mA	25mA	22mA	1.5mA		
MSCP		.159	.215	.398	.215	.247	NA		
Endurance	Hours	2,000 Average						15,000 Average	
Ambient Temperature Range		-20°C ~ +50°C						-20°C ~ +50°C	
Recommended Resistor for Neon: 33K ohms for 110V AC; 100K ohms for 220V AC									
T-1 1/2 Pilot Slide Base		0		No Lamp Code 0 indicates that no lamp is used.					

## ROCKER CAPS, LAMP COVER & FILTER

**1** AT420B  
White Rocker  
without Filters  
or Lamp Covers

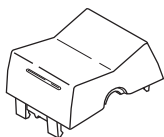

**2** AT420B  
White Rocker  
with Filters

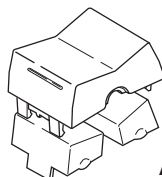

AT421

**3** AT420B  
White Rocker  
with Lamp Covers

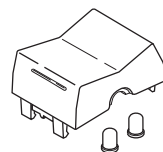

AT416

**4** AT420J  
Clear Rocker  
with Filters

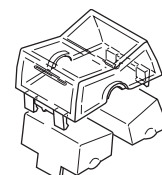

AT421

Rocker Cap Material: Polycarbonate

Finish: Glossy

Indicate the lamp cover or filter color desired in both the up and down positions.

### AT416 Lamp Cover

- C** Red
- D** Amber
- F** Green



Material: Silicon Rubber

- B** White
- C** Red
- D** Amber
- E** Yellow
- F** Green
- G** Blue

### AT421 Filter

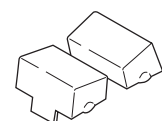

Material: Polycarbonate

## BEZEL & BEZEL COLORS

### AT206 Bezel & Color Codes

<b>No Code</b>	No Bezel	<b>B</b>	White	<b>D</b>	Amber	<b>F</b>	Green	<b>H</b>	Gray
<b>A</b>	Black	<b>C</b>	Red	<b>E</b>	Yellow	<b>G</b>	Blue		

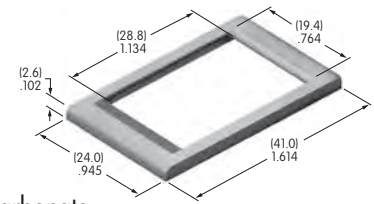

Material: Polycarbonate

## TYPICAL SWITCH DIMENSIONS

### Solder Lug • Without Bezel

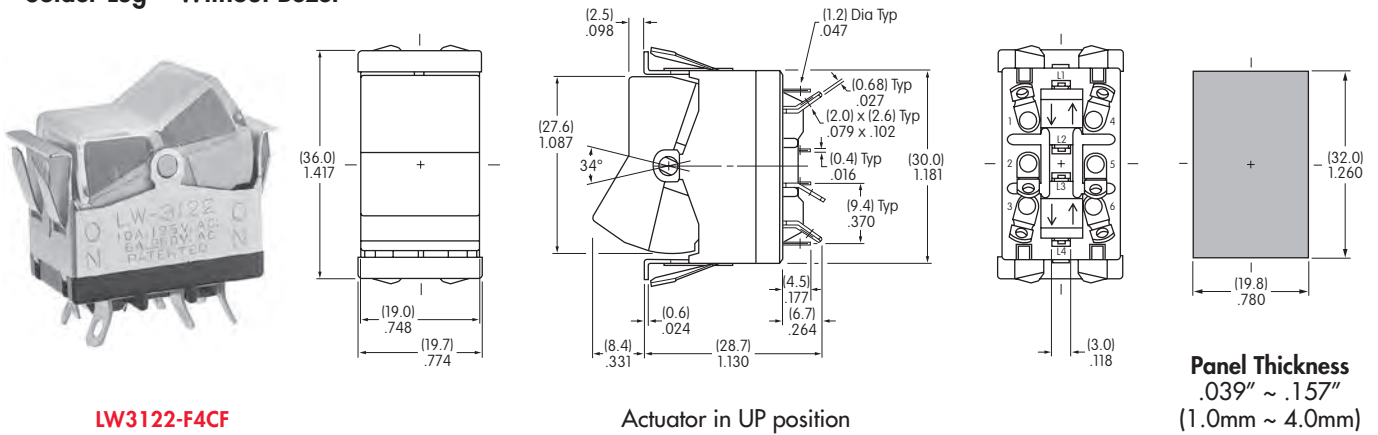

### Solder Lug • With Bezel

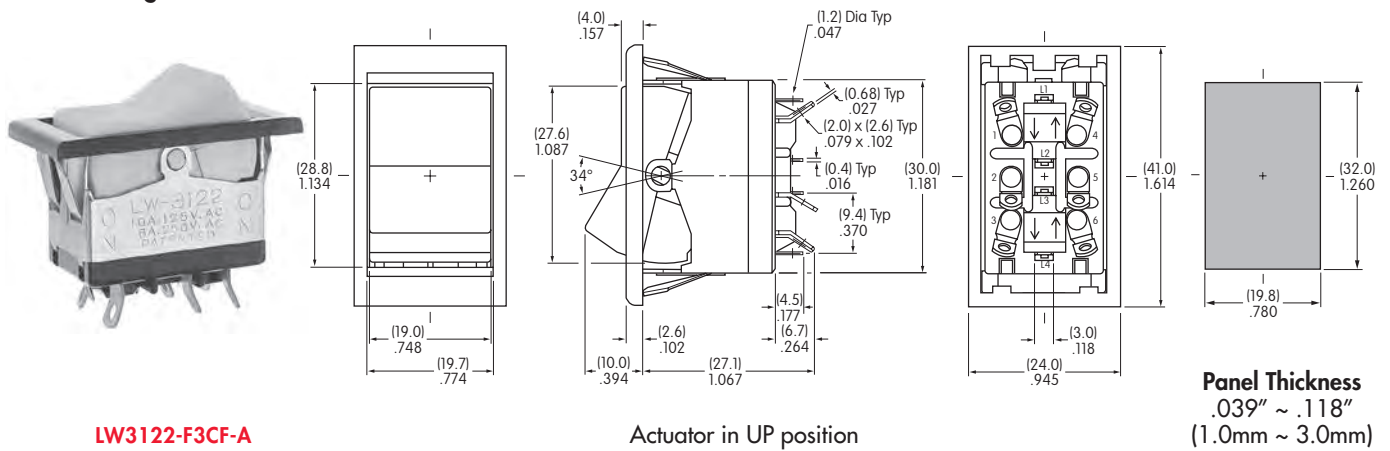

## OPTIONAL ACCESSORY

### AT107 Lamp Extractor

Lamps can be changed without removing the switch from the panel.  
AT107 assists in removing lamps from the switch.

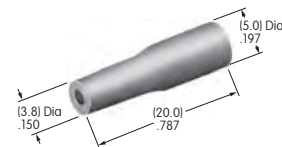

## LEGENDS

Inscriptions can be placed on the rocker or filter.  
Details regarding screen printing may be obtained from the factory.

Toggles  
Rockers  
Pushbuttons  
Illuminated PB  
Programmable  
Keylocks  
Rotaries  
Slides  
Tactiles  
Tilt  
Touch  
Indicators  
Accessories  
Supplement

## GENERAL SPECIFICATIONS

### Electrical Capacity & Other Ratings

<b>Resistive Load:</b>	20A @ 110V AC
<b>Contact Resistance:</b>	10 milliohms maximum
<b>Insulation Resistance:</b>	1,000 megohms minimum @ 500V DC
<b>Dielectric Strength:</b>	2,000V AC minimum for 1 minute minimum
<b>Mechanical Life:</b>	30,000 operations minimum
<b>Electrical Life:</b>	10,000 operations minimum
<b>Operating Temperature Range:</b>	-10°C through +50°C (+14°F through +122°F)
<b>Nominal Operating Force:</b>	1,250 grams
<b>Angle of Throw:</b>	22°

### Materials & Finishes

<b>Rocker:</b>	Polycarbonate resin
<b>Mounting Frame:</b>	Steel with chrome plating
<b>Movable Contacts:</b>	Silver alloy
<b>Stationary Contacts:</b>	Copper with silver plating
<b>Base:</b>	Melamine
<b>Common &amp; End Terminals:</b>	Brass with tin plating

## SINGLE POLE HIGH CAPACITY

Model	Pole	Rocker Position			Connected Terminals			Throw & Power/Lamp Schematics
		Up	Center	Down	Up	Center	Down	
								Notes: Terminal numbers are on switch. Lamp circuit is synchronous to switching circuit.
<b>LW3021A</b>	DP	ON	NONE	OFF	1-3 4-6	OPEN	OPEN	DPST

### Neon Lamp Specifications

.234" x .198" (5.94mm x 5.03mm) window is translucent red.  
Neon lamp with built-in ballast resistor is integral part of switch.

Voltage	V	90 - 120V AC
Internal Series Resistance		100K ohms
Current	I	0.8mA
Endurance		10,000 hours minimum

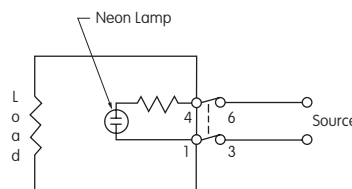

Since this is a double break device, one side of the electrical source should be connected to terminal 3 and the other side to terminal 6. The electrical load should be connected between terminals 1 and 4.

2 screws supplied for flush panel mounting.

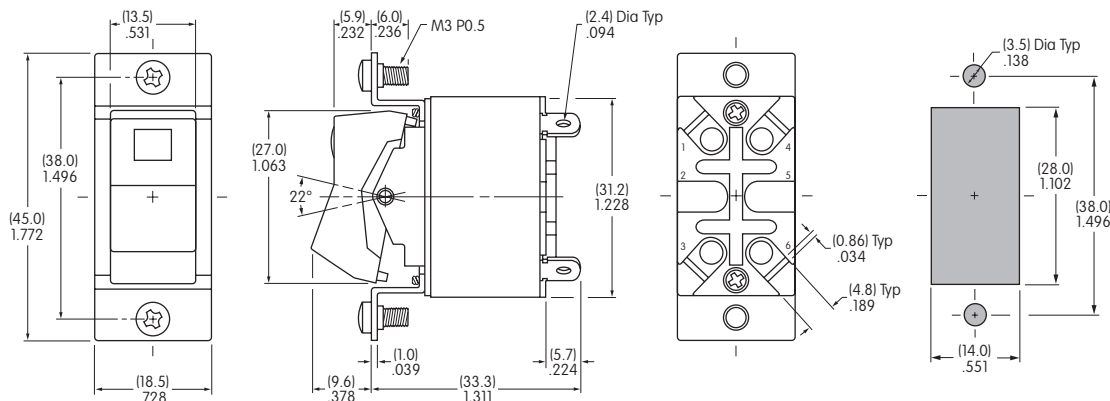

Actuator in UP position

Maximum Panel Thickness:  
.197" (5.0mm)

**LW3021A**

# General Specifications

## B Electrical Capacity (Resistive Load)

**Power Level (silver):** 6A @ 125V AC & 3A @ 250V AC  
4A @ 30V DC for On-None-On; 3A @ 30V DC for all other circuits

**Logic Level (gold):** 0.4VA maximum @ 28V AC/DC maximum  
(Applicable Range 0.1 mA ~ 0.1A @ 20mV ~ 28V)

**Logic/Power Level (gold over silver):** Combines silver & gold ratings

Note: Find additional explanation of dual rating & operating range in Supplement section.

## Other Ratings

**Contact Resistance:** 10 milliohms maximum for silver; 20 milliohms maximum for gold

**Insulation Resistance:** 1,000 megohms minimum @ 500V DC

**Dielectric Strength:** 1,000V AC minimum between contacts for 1 minute minimum;  
1,500V AC minimum between contacts and case for 1 minute minimum

**Mechanical Life:** 50,000 operations minimum

**Electrical Life:** 25,000 operations minimum for silver; 50,000 operations minimum for gold;

50,000 operations minimum for silver at 3A @ 125V AC

**Angle of Throw:** 25°

## Materials & Finishes

**Actuator Clip & Mounting Frame:** Stainless Steel

**Body Frame:** Stainless steel

**Case:** Diallyl phthalate resin (UL94V-0)

**Movable Contactor:** Phosphor bronze with silver or gold plating

**Movable Contacts:** Silver alloy (code W); copper with gold plating (code G); or silver alloy with gold plating (code A)

**Stationary Contacts:** Silver with silver plating (code W); copper or brass with gold plating (code G);  
or silver with gold plating (code A)

**Terminals:** Copper or brass with silver plating; or copper or brass with gold plating

## Environmental Data

**Operating Temp Range:** -30°C through +85°C (-22°F through +185°F)

**Humidity:** 90 ~ 95% humidity for 96 hours @ 40°C (104°F)

**Vibration:** 10 ~ 55Hz with peak-to-peak amplitude of 1.5mm traversing the frequency range & returning  
in 1 minute; 3 right angled directions for 2 hours

**Shock:** 50G (490m/s<sup>2</sup>) acceleration (tested in 6 right angled directions, with 5 shocks in each direction)

## Processing

**Soldering:** Wave Soldering (PC version) for Gold: See Profile A in Supplement section.

Manual Soldering for Gold: See Profile A in Supplement section.

Wave Soldering (PC version) for Silver: See Profile B in Supplement section.

Manual Soldering for Silver: See Profile B in Supplement section.

Note: Actuator must be in OFF (center) position while soldering.

**Cleaning:** These devices are not process sealed. Hand clean locally using alcohol based solution.

## Standards & Certifications

**Flammability Standards:** UL94V-0 for case

**UL:** File No. E44145 - Recognized only when ordered with marking on switch.

Add "/U" or "/CUL" before first dash in part number to order UL recognized switch.

All models recognized at 6A @ 125V AC, 3A @ 250V AC or 0.4VA maximum @ 28V DC maximum.

**CSA:** File No. 023535\_0\_000 - Certified only when ordered with marking on switch.

Add "/C" before first dash in part number to order CSA certified switch.

All models certified at 6A @ 125V AC or 3A @ 250V AC or 0.4VA maximum @ 28V maximum.

# Distinctive Characteristics

Three methods of panel mounting: flat frame for flush with face or subpanel, snap-in, and PCB.

High insulating barriers increase isolation of circuits in multipole devices and provide added protection to contact points.

The molded diallyl phthalate case has a UL 94V-0 flammability rating.

Epoxy sealed terminals prevent entry of solder flux and other contaminants.

Prominent external insulating barriers increase insulation resistance and dielectric strength.

Bias guard prevents misalignment of contacts; interlocking of actuator block with rocker and internal guide does not allow transmission of diagonal force on rocker to reach contact mechanism.

Clinching the frame to the case well above the base and terminals provides 1,500V dielectric strength.

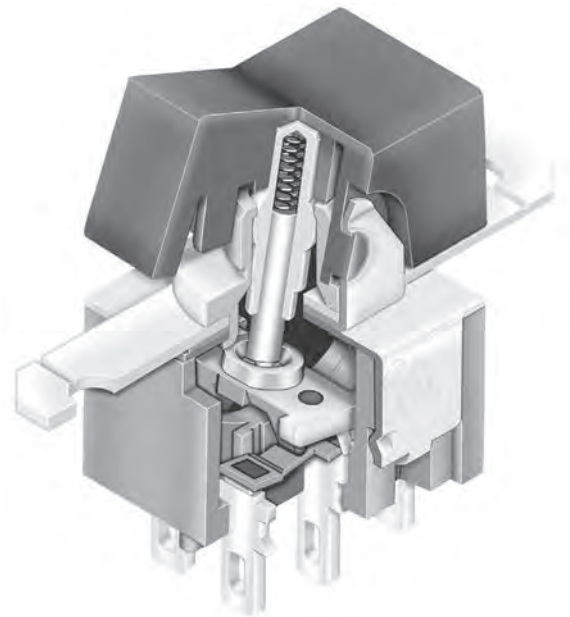

Actual Size

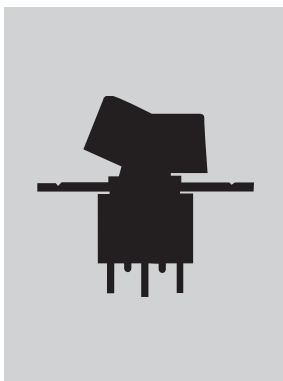

Snap-in Mount

Page B64



Bracket PC Mount

Page B72



Flat Frame Mount

Page B83

Toggles

Rockers  
B

Pushbuttons

Illuminated PB

Programmable

Keylocks

Rotaries

Slides

Tactiles

Tilt

Touch

Indicators

Accessories

Supplement

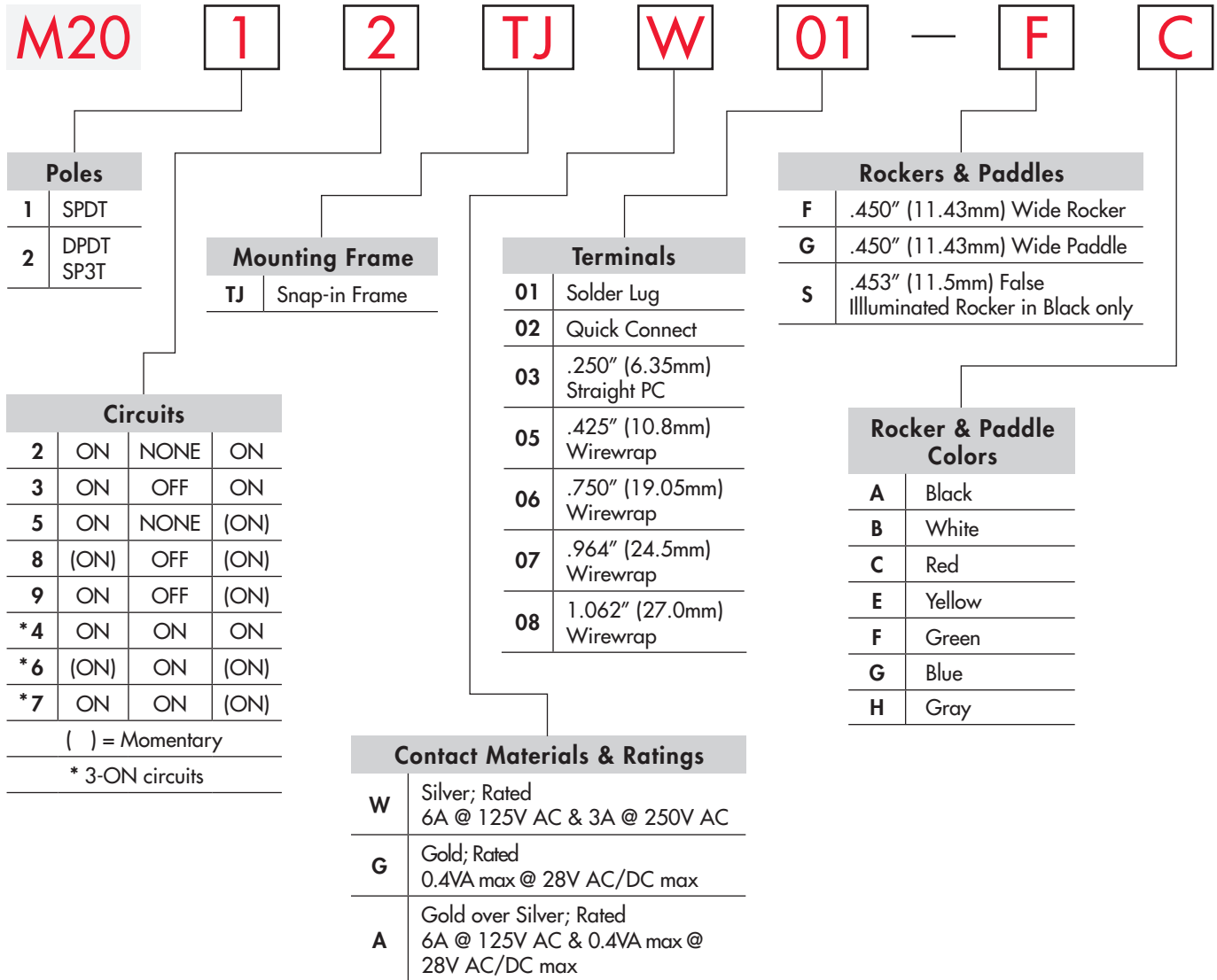

#### DESCRIPTION FOR TYPICAL ORDERING EXAMPLE

#### M2012JW01-FC-1A



## ORDERING EXAMPLE

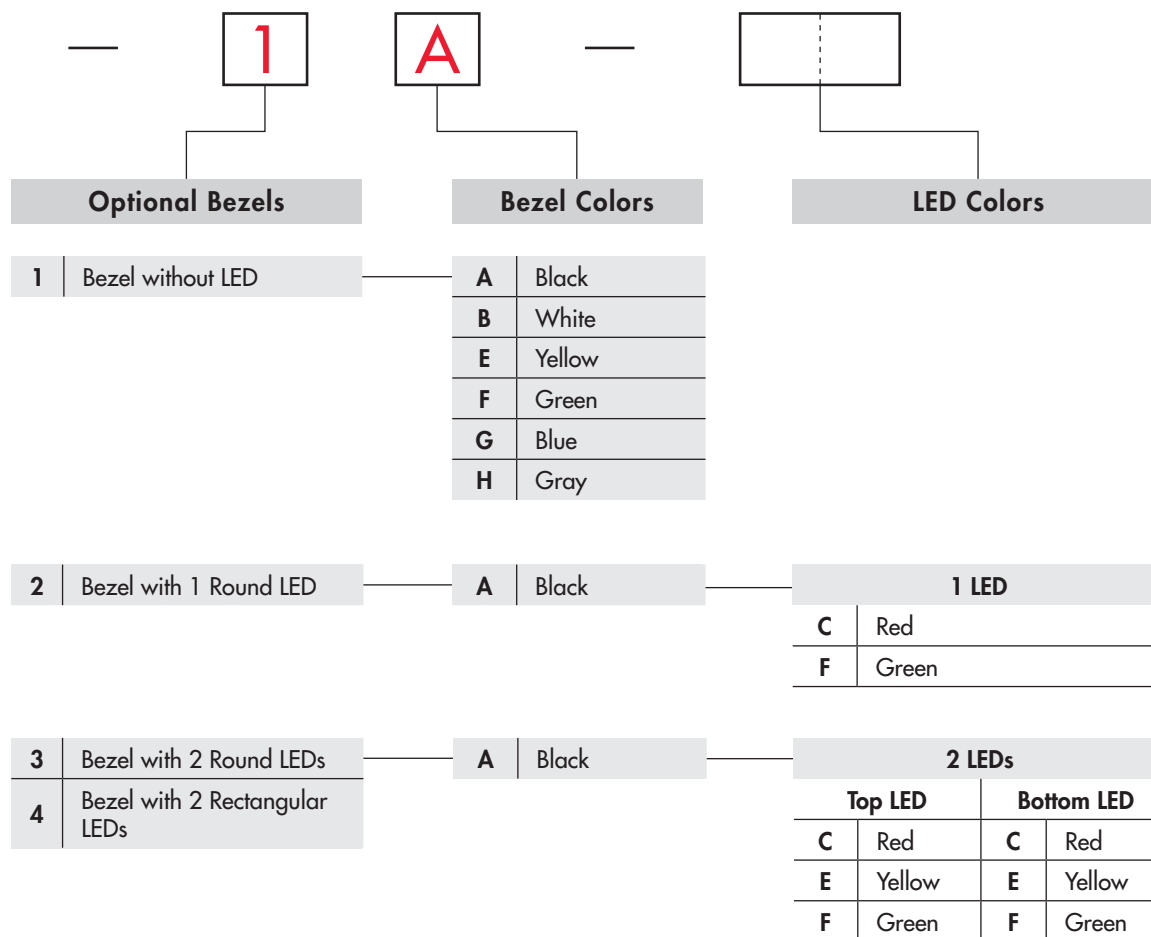

### IMPORTANT:



Switches are supplied without UL, cULus & CSA marking unless specified.  
**UL, cULus & CSA recognized only when ordered with marking on the switch.**  
 Specific models, ratings, & ordering instructions are noted on the General Specifications page.

### DESCRIPTION FOR TYPICAL ORDERING EXAMPLE

**M2012TJW01-FC-3A-CF**

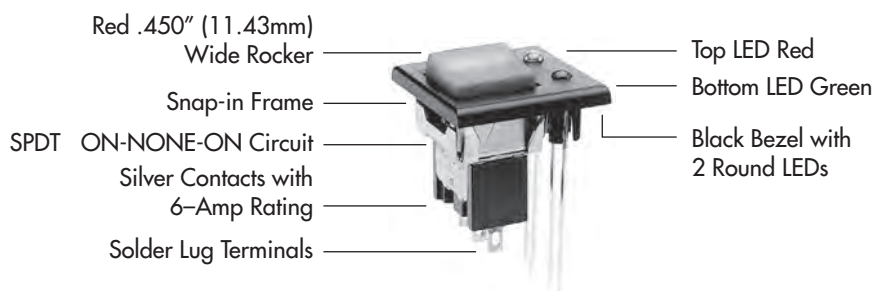

Toggle

Rockers **B**

Pushbuttons

Illuminated PB

Programmable

Keylocks

Rotaries

Slides

Tactiles

Tilt

Touch

Indicators

Accessories

Supplement

## POLES & CIRCUITS

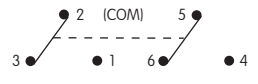
Pole	Model	Rocker Position ( ) = Momentary			Connected Terminals			Throw & Schematics
		Down	Center	Up	Down	Center	Up	
SP	M2012	ON	NONE	ON	2-3	OPEN	2-1	SPDT 
	M2013	ON	OFF	ON				
	M2015	ON	NONE	(ON)				
	M2018	(ON)	OFF	(ON)				
	M2019	ON	OFF	(ON)				
DP	M2022	ON	NONE	ON	2-3 5-6	OPEN	2-1 5-4	DPDT 
	M2023	ON	OFF	ON				
	M2025	ON	NONE	(ON)				
	M2028	(ON)	OFF	(ON)				
	M2029	ON	OFF	(ON)				

### For 3 Throw (3-On)

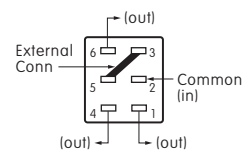
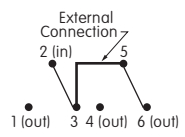
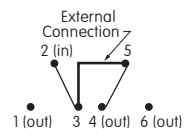
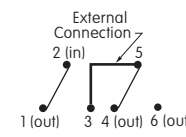
Pole	Model	Connected Terminals & Schematic			External Connection
		Down	Center	Up	
SP	M2024	ON	ON	ON	<b>The SP3T model utilizes a double pole base.</b>  External connection must be made during field installation. 
	M2026	(ON)	ON	(ON)	
	M2027	ON	ON	(ON)	
		 2-3 5-6	 2-3 5-4	 2-1 5-4	

## MOUNTING FRAME

**TJ**

### Snap-in Frame

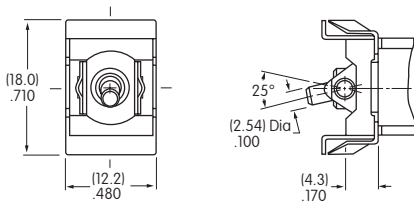

Panel Cutout for Single Pole without Bezel

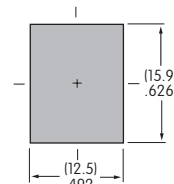

Panel Cutout for Double Pole without Bezel

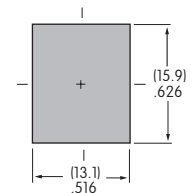

Panel Thickness without Bezel: .039" ~ .126" (1.0mm ~ 3.2mm)  
 Panel Thickness with Bezel: .039" ~ .098" (1.0mm ~ 2.5mm)

## CONTACT MATERIALS & RATINGS

**W**

Silver over Silver

Power Level

6A @ 125V AC & 3A @ 250V AC

**G**

Gold over Brass or Copper

Logic Level

0.4VA maximum @ 28V AC/DC maximum

Note: See Supplement section to find complete explanation of operating range.

**A**

Gold over Silver

Power Level  
or Logic Level

6A @ 125V AC  
or 0.4VA maximum @ 28V AC/DC maximum

Note: This dual rated option is suitable when two or more identical switches are used in logic and in power circuits within the same application. See Supplement section to find complete explanation of dual rating and operating range.



## TERMINALS

Toggle

**B** Rockers

Pushbuttons

Illuminated PB

Programmable

Key locks

Rotaries

Slides

Tactiles

Tilt

Touch

Indicators

Accessories

Supplement

**01** Solder Lug

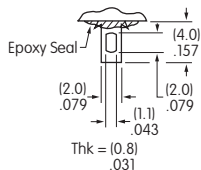

**02** .062" (1.57mm) Wide Quick Connect

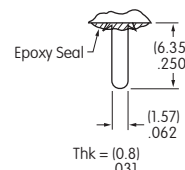

**03** .250" (6.35mm) Straight PC

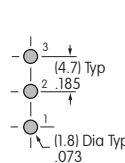
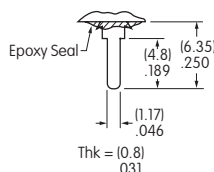

Single Pole

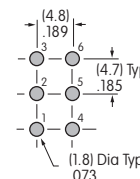

Double Pole

**05** .425" (10.8mm) Wirewrap or Extended PC

**06** .750" (19.05mm) Wirewrap or Extended PC

**07** .964" (24.5mm) Wirewrap or Extended PC

**08** 1.062" (27.0mm) Wirewrap or Extended PC

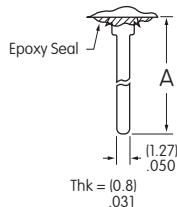

If using as extended PC terminal, refer to the above footprints.

Dimension A = terminal lengths as shown beside the terminal codes at the left.

## ROCKERS & PADDLES

**F** AT4150  
.450" (11.43mm)  
Wide Rocker

Material: Polyamide  
Finish: Matte

Colors Available:  
A, B, C, E, F, G, H

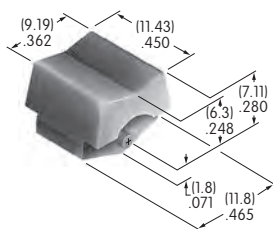

**G** AT4151  
.450" (11.43mm)  
Wide Paddle

Material: Polyamide  
Finish: Matte

Colors Available:  
A, B, C, E, F, G, H

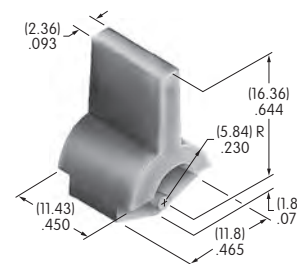

**S** AT466 .453" (11.5mm)  
False Illuminated Rocker

	<u>Rocker</u>	<u>False Illuminator</u>
Material:	Polycarbonate	Acrylonitrile Butadiene Styrene
Finish:	Glossy	
Colors:	Black	White and Red

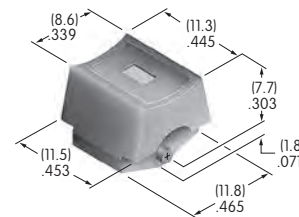

When a bezel is selected with AT466, glossy polycarbonate AT207 is supplied.

Cap Colors Available:

- A** Black
- B** White
- C** Red
- E** Yellow
- F** Green
- G** Blue
- H** Gray

### OPTIONAL SNAP-IN BEZELS & BEZEL COLORS

#### 1 AT2107 Bezel

Material: Polyamide

Finish: Matte

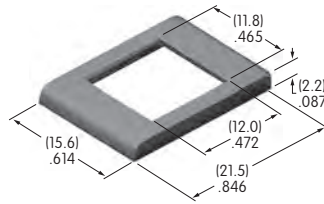

- A** Black
- B** White
- E** Yellow
- F** Green
- G** Blue
- H** Gray

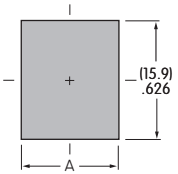

	Single Pole	Double Pole
A	(12.5)mm .492"	(13.1)mm .516"

#### 2 AT208 Bezel for AT070 LED

Material: Polycarbonate

Finish: Glossy

Contact factory for matte finish.

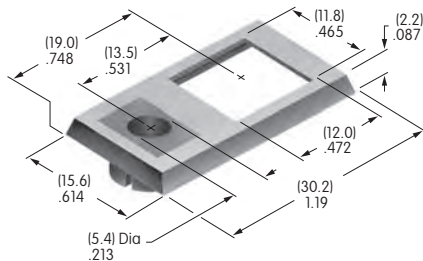

- A** Black
- LED colors & specifications on next page.

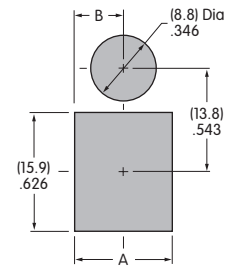

	Single Pole	Double Pole
A	(12.5)mm .492"	(13.1)mm .516"
B	(6.25)mm .246"	(6.55)mm .258"

#### 3 AT212 Bezel for AT617 LED

Material: Polycarbonate

Finish: Semi-glossy

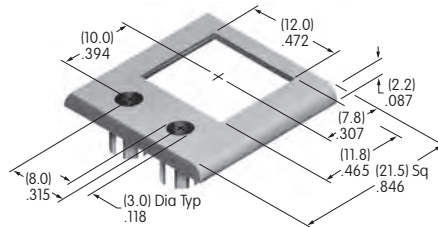

- A** Black

LED colors & specifications on next page.

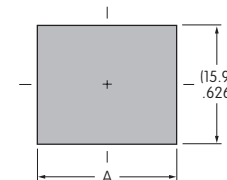

	Single Pole	Double Pole
A	(18.4)mm .724"	(18.7)mm .736"

#### 4 AT213 Bezel for AT618 LED

Material: Polycarbonate

Finish: Semi-glossy

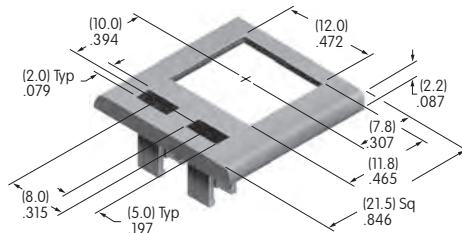

- A** Black

LED colors & specifications on next page.

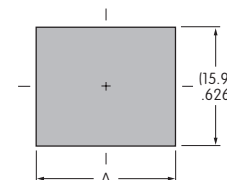

	Single Pole	Double Pole
A	(18.4)mm .724"	(18.7)mm .736"

### Bezel Assembly

1. Pry out tab on bezel to a 45° angle.

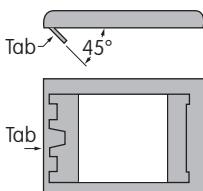

2. Insert switch frame under tab and snap on bezel.

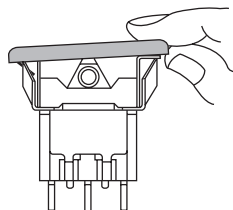

3. Push tab back into place.

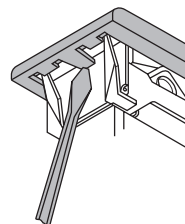

4. Snap assembled bezel and switch into panel.

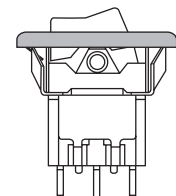

## LED COLORS & SPECIFICATIONS

### Bezel Orientation on Switch

**AT070 LED**  
For Bezel AT208  
with 1 LED

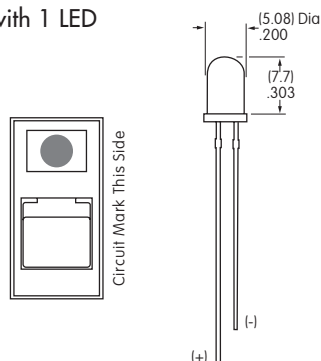

**AT617 LED**  
For Bezel AT212  
with 2 Round LEDs

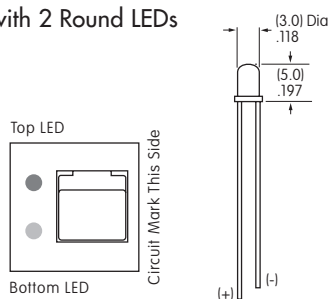

**AT618 LED**  
For Bezel AT213  
with 2 Rectangular LEDs

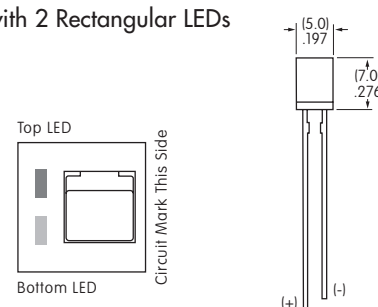

Note: Lead lengths may differ from manufacturing lot to lot. The longer lead is the anode (+).

		AT070		AT617			AT618		
		<b>C</b>	<b>F</b>	<b>C</b>	<b>E</b>	<b>F</b>	<b>C</b>	<b>E</b>	<b>F</b>
Color		Red	Green	Red	Yellow	Green	Red	Yellow	Green
Maximum Forward Current	$I_{FM}$	25mA	50mA	30mA	30mA	25mA	25mA	30mA	25mA
Typical Forward Current	$I_F$	20mA	30mA	20mA	20mA	20mA	20mA	20mA	20mA
Forward Voltage	$V_F$	2.8V	2.1V	2.0V	2.1V	2.2V	2.25V	2.1V	2.2V
Maximum Reverse Voltage	$V_{RM}$	4V	5V	5V	5V	5V	5V	5V	5V
Current Reduction Rate Above 25°C	$\Delta I_F$	0.33 mA/°C	0.40 mA/°C	0.40 mA/°C	0.40 mA/°C	0.33 mA/°C	0.33 mA/°C	0.40 mA/°C	0.33 mA/°C
Ambient Temperature Range (when used with a bezel)		-10° ~ +70°C		-15° ~ +70°C			-25° ~ +70°C		

The electrical specifications shown are determined at a basic temperature of 25°C. LED circuit is independent of switch operation. LED is colored in OFF state.

If the source voltage is greater than the rated voltage of the LED, a ballast resistor must be connected in series with the lamp. The ballast resistor calculation and more lamp detail are shown in the Supplement section.

## LEGENDS

NKK Switches can provide custom legends for caps. Contact factory for more information.

### Suggested Printable Area for Cap

#### Recommended Print Method:

Pad Print

Epoxy based ink is recommended.



AT4150

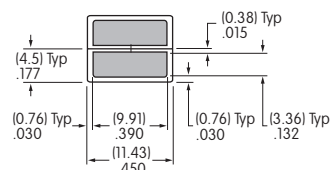

Shaded areas are printable areas.

## TYPICAL SWITCH DIMENSIONS

### Snap-in Frame • Solder Lug

### Single Pole

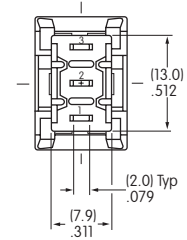
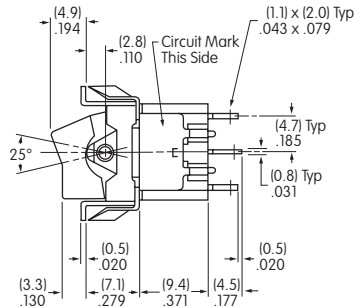
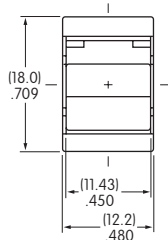

M2012JW01-FC

### Snap-in Frame • Solder Lug

### Double Pole

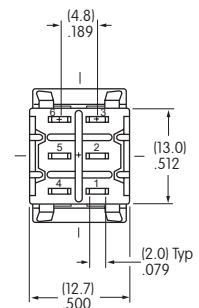
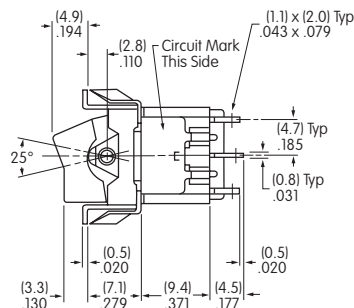
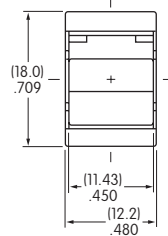

M2022JW01-FC

### Snap-in Frame • Solder Lug

### Single Pole

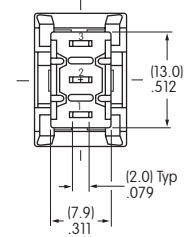
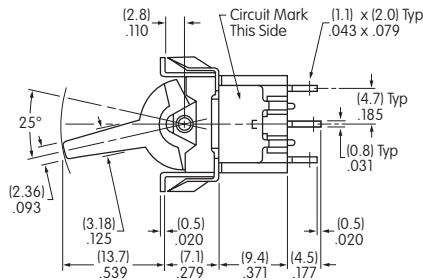
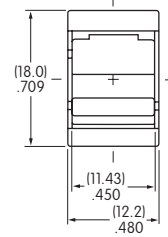

M2012JW01-GC

### Snap-in Frame • Solder Lug

### Double Pole

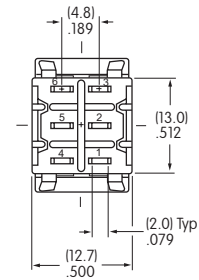
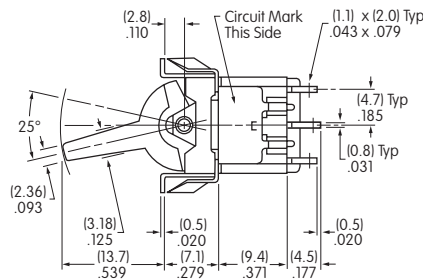
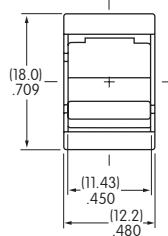

M2022JW01-GC

## TYPICAL SWITCH DIMENSIONS

### Single & Double Pole

### Snap-in Frame • AT2107 Bezel • Solder Lug

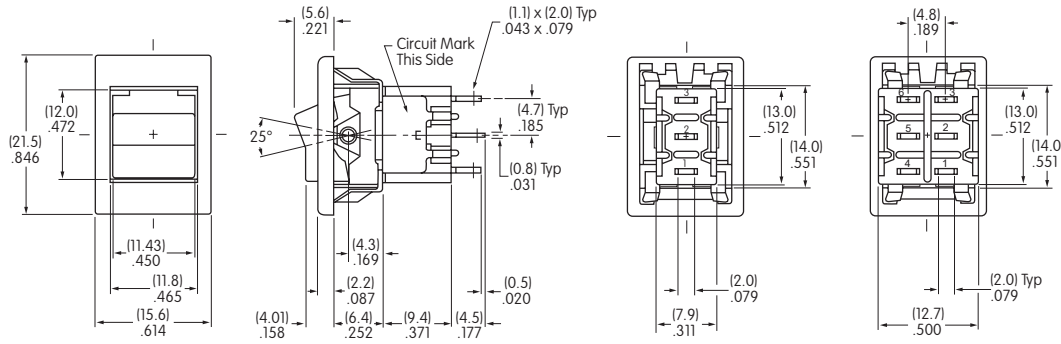

M2012JW01-FC-1A

### Double Pole

### Snap-in Frame • AT208 Bezel • Solder Lug

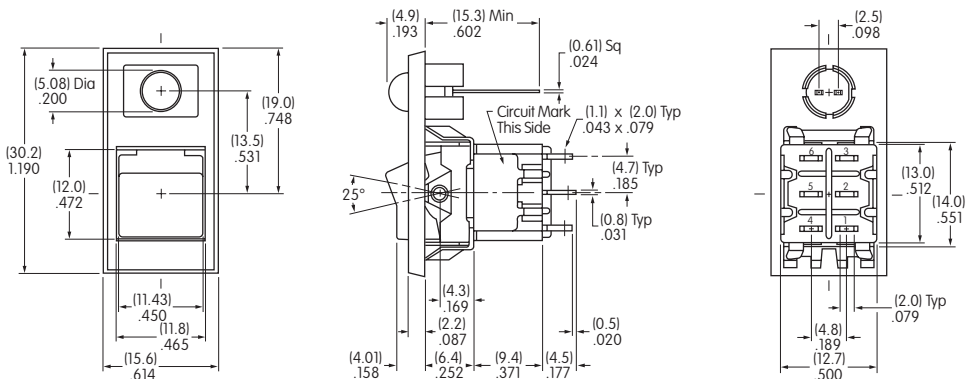

M2022JW01-FC-2A-C

### Single Pole

### Snap-in Frame • AT212 Bezel • Solder Lug

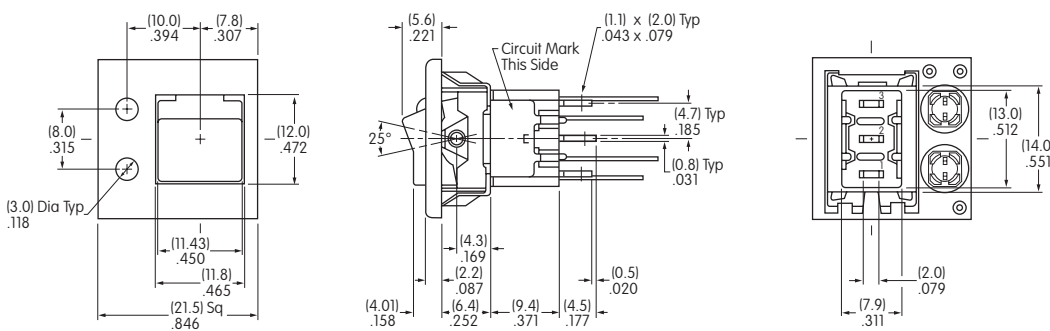

M2012JW01-FC-3A-CF

### Double Pole

### Snap-in Frame • AT213 Bezel • Solder Lug

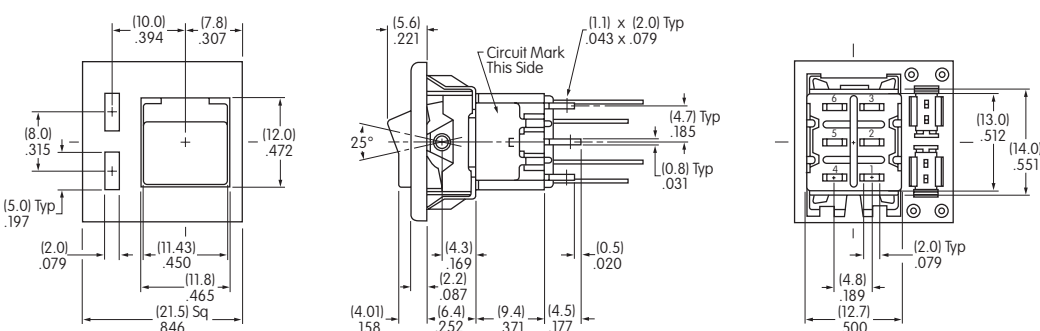

M2022JW01-FC-4A-CF

**M20**

**1**

**3**

**TX**

**G**

Poles	
1	SPDT
2	DPDT SP3T
3	3PDT (used only with terminal codes 30 & 41 & frame code TX)
4	4PDT DP3T (used only with terminal code 41 & frame code TX)

Mounting Frames	
TX	Narrow Frame for Small Actuator
TZ	Wide Frame for Large Actuator

Circuits			
2	ON	NONE	ON
3	ON	OFF	ON
5	ON	NONE	(ON)
8	(ON)	OFF	(ON)
9	ON	OFF	(ON)
*4	ON	ON	ON
*6	(ON)	ON	(ON)
*7	ON	ON	(ON)

( ) = Momentary  
\* 3-ON circuits

Contact Materials & Ratings	
W	Silver; Rated 6A @ 125V AC & 3A @ 250V AC
G	Gold; Rated 0.4VA max @ 28V AC/DC max
A	Gold over Silver; Rated 6A @ 125V AC & 0.4VA max @ 28V AC/DC max

#### DESCRIPTION FOR TYPICAL ORDERING EXAMPLE

**M2013TXG41-DC**



ORDERING EXAMPLE

<b>41</b>	
<b>Terminals For TX &amp; TZ Frames</b>	
<b>Straight PC with Bracket (1-2 Pole only)</b>	
13	.250" (6.35mm) Straight PC with .465" (11.8mm) Bracket
15	.425" (10.8mm) Straight PC with .630" (16.0mm) Bracket
17	.964" (24.5mm) Straight PC with 1.150" (29.2mm) Bracket
<b>Straight PC with Reinforced Bracket (1-2 Pole only)</b>	
23	.250" (6.35mm) Straight PC with .465" (11.8mm) Bracket
25	.425" (10.8mm) Straight PC with .630" (16.0mm) Bracket
26	.750" (19.05mm) Straight PC with .953" (24.2mm) Bracket
<b>Terminals For TX Frame Only</b>	
<b>Right Angle PC with Support (1-3 Pole only)</b>	
30	.150" (3.81mm) Right Angle PC
<b>Vertical PC with Support (1-4 Pole)</b>	
41	.150" (3.81mm) Vertical PC

<b>D</b>		<b>C</b>	
<b>Rockers &amp; Paddles</b>			
<b>Small Actuators (TX Frame)</b>			
D	.365" (9.27mm) Wide Rocker		
E	.365" (9.27mm) Wide Paddle		
F	.450" (11.43mm) Wide Rocker		
G	.450" (11.43mm) Wide Paddle		
<b>Large Actuators (TZ Frame)</b>			
J	.595" (15.11mm) Wide Rocker		
H	.595" (15.11mm) Wide Paddle		

<b>Rocker &amp; Paddle Colors</b>	
A	Black
B	White
C	Red
E	Yellow
F	Green
G	Blue
H	Gray

**IMPORTANT:**

 Switches are supplied without UL & CSA marking unless specified. **UL & CSA recognized only when ordered with marking on the switch.** Specific models, ratings and ordering instructions are noted on the General Specifications page.

DESCRIPTION FOR TYPICAL ORDERING EXAMPLE

**M2022TZG23-JC**

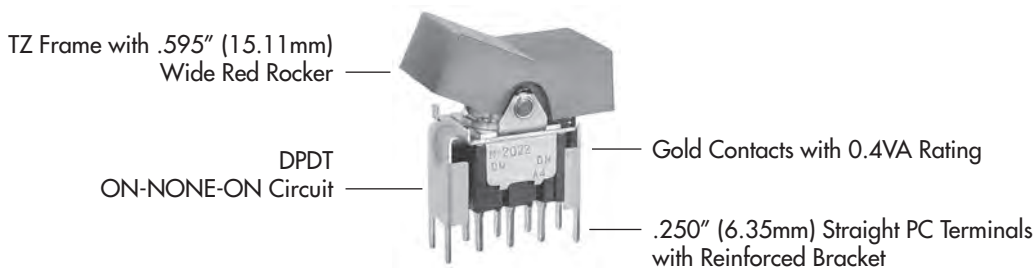

Toggles  
 Rockers  
 Pushbuttons  
 Illuminated PB  
 Programmable  
 Key locks  
 Rotaries  
 Slides  
 Tactiles  
 Tilt  
 Touch  
 Indicators  
 Accessories  
 Supplement

Toggles

Rockers **B**

Pushbuttons

Illuminated PB

Programmable

Keylocks

Rotaries

Slides

Tactiles

Tilt

Touch

Indicators

Accessories

Supplement

### POLES & CIRCUITS

Pole	Model	Rocker Position ( ) = Momentary			Connected Terminals			Throw & Schematics
		Down	Center	Up	Down	Center	Up	
SP	M2012 M2013 *M2015 M2018 *M2019	ON ON ON (ON) ON	NONE OFF NONE OFF OFF	ON ON (ON) ON ON	2-3	OPEN	2-1	Note: Terminal numbers are not actually on the switch. * Reverse circuits available for vertical mount SP & DP upon request.  SPDT 
DP	M2022 M2023 *M2025 M2028 *M2029	ON ON ON (ON) ON	NONE OFF NONE OFF OFF	ON ON (ON) ON ON	2-3 5-6	OPEN	2-1 5-4	DPDT 
3P	M2022 M2023 *M2025 M2028 *M2029	ON ON ON (ON) ON	NONE OFF NONE OFF OFF	ON ON (ON) ON ON	2-3 5-6 8-9	OPEN	2-1 5-4 8-7	3PDT 
4P	M2042 M2043 *M2045 M2048 *M2049	ON ON ON (ON) ON	NONE OFF NONE OFF OFF	ON ON (ON) ON ON	2-3 5-6 8-9 11-12	OPEN	2-1 5-4 8-7 11-10	4PDT 

#### For 3 Throw (3-On)

#### Connected Terminals & Schematics

Pole	Model	Down	Center	Up	Down	Center	Up
SP	M2024 M2026 M2027	ON (ON) ON	ON ON ON	ON (ON) (ON)			
DP	M2044 M2046 M2047	ON (ON) ON	ON ON ON	ON (ON) (ON)			

The SP3T model utilizes a double pole base.

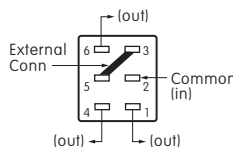

External connection must be made during field installation.

The DP3T model utilizes a four pole base.

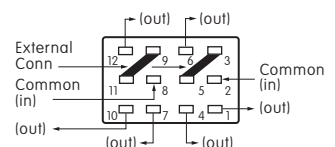

External connection must be made during field installation.



MOUNTING FRAMES

**TX** Narrow Mounting Frame for Small Actuators with Straight PC Terminals (codes 13, 15, 17, 23, 25, & 26) or with Angle PC Terminals (codes 30 & 41)

Straight PC Mounting

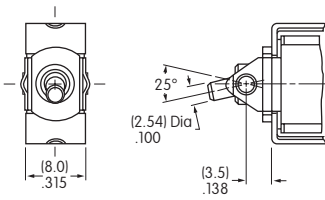

Right Angle PC Mounting

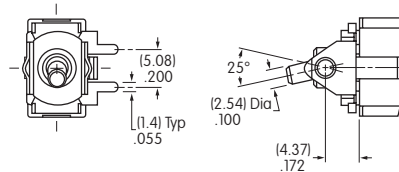

Vertical PC Mounting

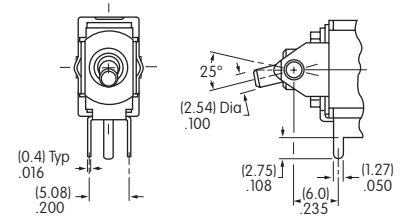

Small Actuators & Panel Cutouts for TX Frame (actuator details on the following pages)

AT4148

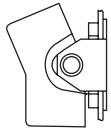

AT4149

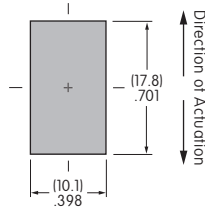
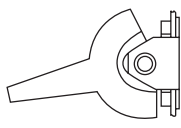

AT4150

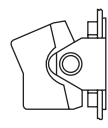

AT4151

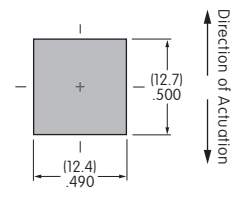
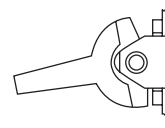

**TZ** Wide Mounting Frame for Large Actuators with Straight PC Terminals (codes 13, 15, 17, 23, 25, & 26)

Large Actuators & Panel Cutouts for TZ Frame (actuator details on the following pages)

AT4156

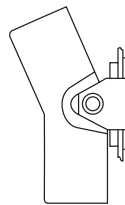

AT4157

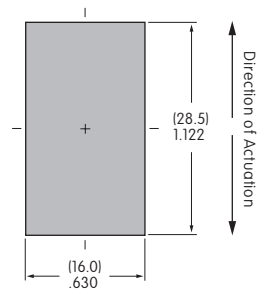
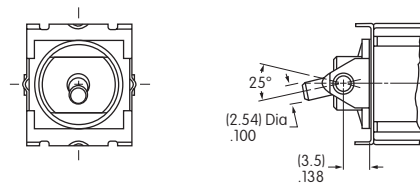
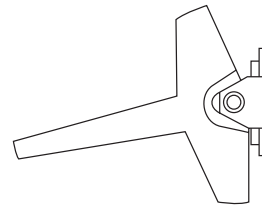

CONTACT MATERIALS & RATINGS

**W** Silver over Silver Power Level 6A @ 125V AC & 3A @ 250V AC

**G** Gold over Brass or Copper Logic Level 0.4VA maximum @ 28V AC/DC maximum

Note: See Supplement section to find complete explanation of operating range.

**A** Gold over Silver Power Level or Logic Level 6A @ 125V AC or 0.4VA maximum @ 28V AC/DC maximum

Note: This dual rated option is suitable when two or more identical switches are used in logic and in power circuits within the same application. See Supplement section to find complete explanation of dual rating and operating range.

### TERMINALS

For TX and TZ 1-2 Pole  
Straight PC Mount with Bracket

For TX and TZ 1-2 Pole  
Straight PC Mount with Reinforced Bracket

**13**

.250" (6.35mm)  
Terminal with  
.465" (11.8mm)  
Bracket

**15**

.425" (10.8mm)  
Terminal with  
.630" (16.0mm)  
Bracket

**17**

.964" (24.5mm)  
Terminal with  
1.150" (29.2mm)  
Bracket

**23**

.250" (6.35mm)  
Terminal with  
.465" (11.8mm)  
Bracket

**25**

.425" (10.8mm)  
Terminal with  
.630" (16.0mm)  
Bracket

**26**

.750" (19.05mm)  
Terminal with  
.953" (24.2mm)  
Bracket

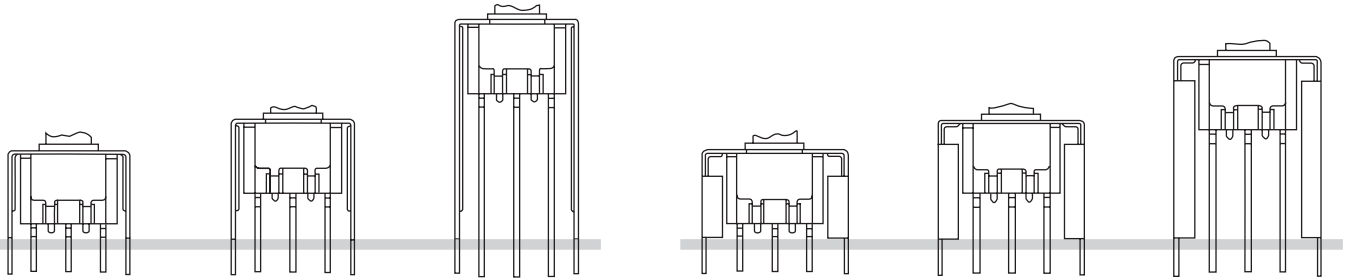

PCB footprints are on the following Typical Switch Dimension pages.

For TX 1-3 Pole Right Angle PC Mount

For TX 1-4 Pole Vertical PC Mount

**30**

.150" (3.81mm)  
Right Angle PC

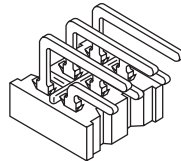

**41**

.150" (3.81mm)  
Vertical PC

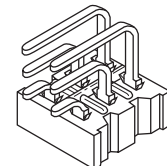

### ROCKERS & PADDLES FOR TX MOUNTING FRAMES

**D**

AT4148 .365" (9.27mm)  
Wide Rocker

Material: Polyamide  
Finish: Matte

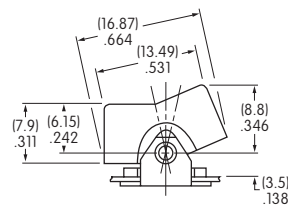
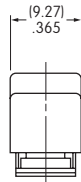

**E**

AT4149 .365" (9.27mm)  
Wide Paddle

Material: Polyamide  
Finish: Matte

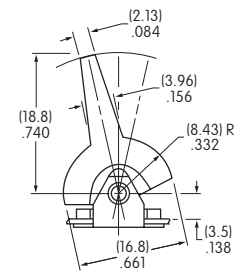

**F**

AT4150 .450" (11.43mm)  
Wide Rocker

Material: Polyamide  
Finish: Matte

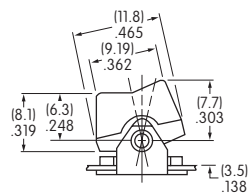
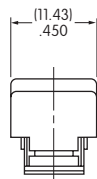

**G**

AT4151 .450" (11.43mm)  
Wide Paddle

Material: Polyamide  
Finish: Matte

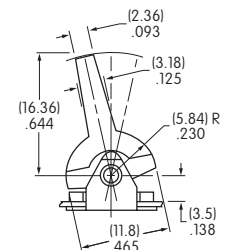
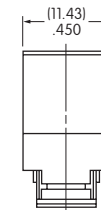

Cap Colors  
Available:

**A**

Black

**B**

White

**C**

Red

**E**

Yellow

**F**

Green

**G**

Blue

**H**

Gray

ROCKERS & PADDLES FOR TZ MOUNTING FRAMES

**J** AT4156 .595" (15.11mm)  
Wide Rocker

Material: Polyamide  
Finish: Matte

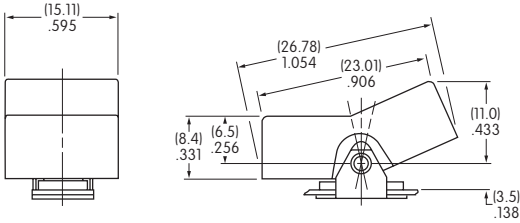

**H** AT4157 .595" (15.11mm)  
Wide Paddle

Material: Polyamide  
Finish: Matte

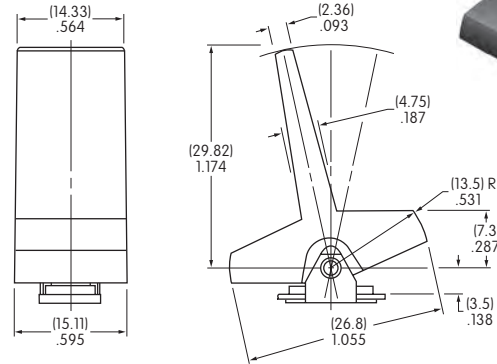

Cap Colors Available:



Black



White



Red



Yellow



Green



Blue



Gray

OPTIONAL SNAP-IN PANEL FRAMES

Used with AT4148 Rocker and AT4149 Paddle

**AT064-1**

Accommodates .047" ~ .090"  
(1.2 ~ 2.3mm) panel thickness

Material: Polyamide  
Finish: Matte  
Color: Black

Mounted separately from switches

Cutout Tolerances:

Dimension A:  
.797" ~ .803" (20.24 ~ 20.4mm)

Dimension B:  
.495" ~ .505" (12.57 ~ 12.83mm)

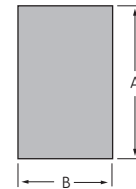

**AT064-2**

Accommodates .062" ~ .125"  
(1.57 ~ 3.18mm) panel thickness

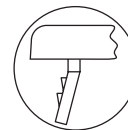
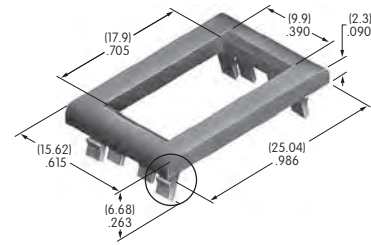

AT064-1 Enlarged Detail

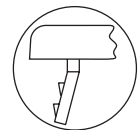

Used with AT4150 Rocker and AT4151 Paddle

**AT065-1**

Accommodates .047" ~ .090"  
(1.2 ~ 2.3mm) panel thickness

Material: Polyamide  
Finish: Matte  
Color: Black

Mounted separately from switches

Cutout Tolerances:

Dimension A:  
.595" ~ .605" (15.11 ~ 15.37mm)

Dimension B:  
.495" ~ .500" (12.57 ~ 12.7mm)



**AT065-2**

Accommodates .062" ~ .125"  
(1.57 ~ 3.18mm) panel thickness

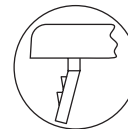
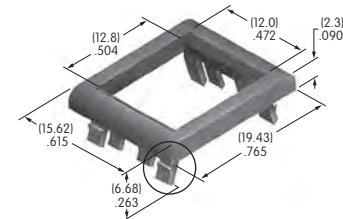

AT065-1 Enlarged Detail

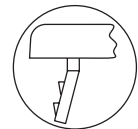

AT065-2 Enlarged Detail

## TYPICAL SWITCH DIMENSIONS

### Straight PC • Bracket

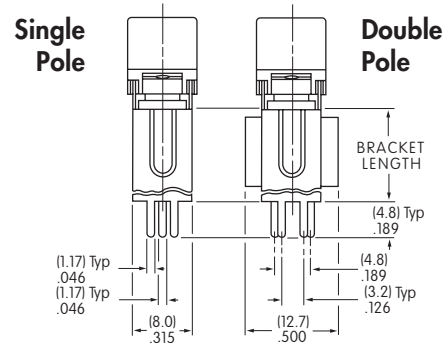
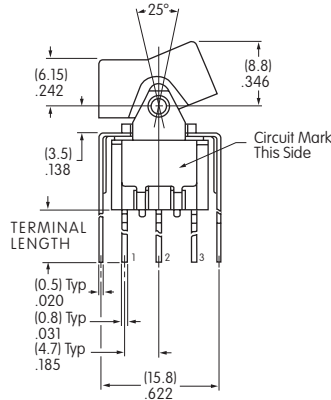

**M2012TXG13-DC**

Terminal Code:	Terminal Length:	Bracket Length:
<b>13</b>	.250" (6.35mm)	.465" (11.8mm)
<b>15</b>	.425" (10.8mm)	.630" (16.0mm)
<b>17</b>	.964" (24.5mm)	1.150" (29.2mm)

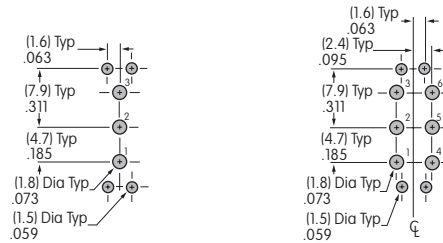

### Straight PC • Reinforced Bracket

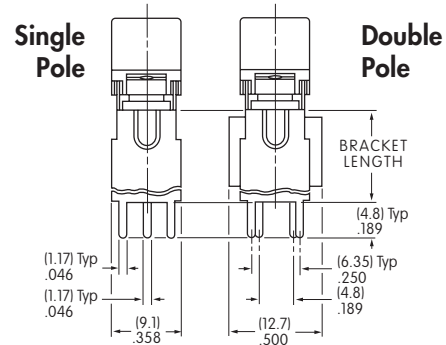
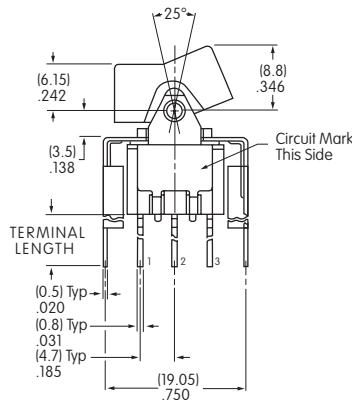

**M2012TXG23-DC**

Terminal Code:	Terminal Length:	Bracket Length:
<b>23</b>	.250" (6.35mm)	.465" (11.8mm)
<b>25</b>	.425" (10.8mm)	.630" (16.0mm)
<b>26</b>	.750" (19.05mm)	.953" (24.2mm)

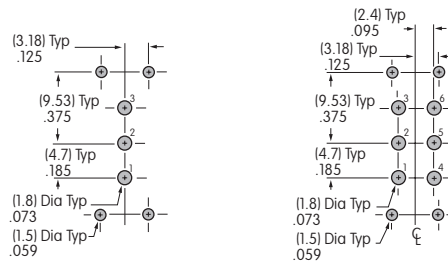

Toggles

Rockers **B**

Pushbuttons

Illuminated PB

Programmable

Keylocks

Rotaries

Slides

Tactiles

Tilt

Touch

Indicators

Accessories

Supplement

TYPICAL SWITCH DIMENSIONS

Single Pole

.150" (3.81mm) Right Angle PC

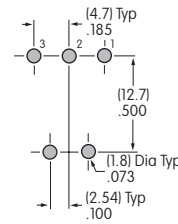
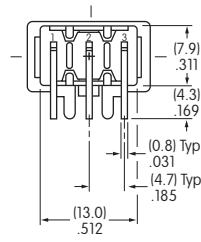
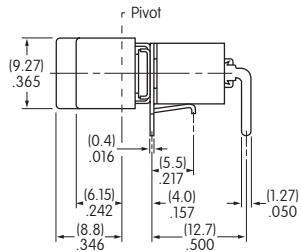
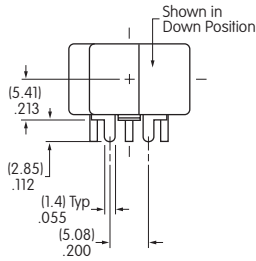

M2012TXG30-DC

Double Pole

.150" (3.81mm) Right Angle PC

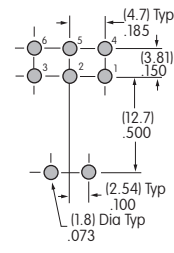
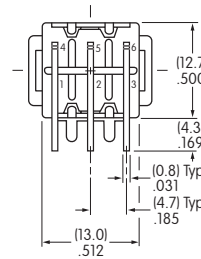
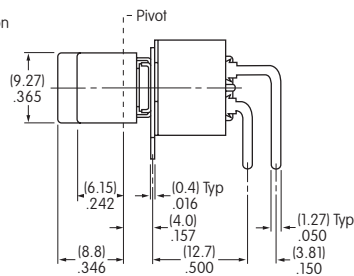
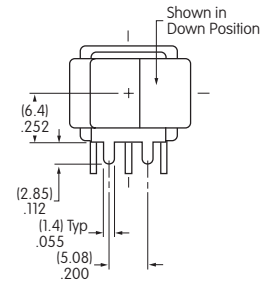

M2022TXG30-DC

Three Pole

.150" (3.81mm) Right Angle PC

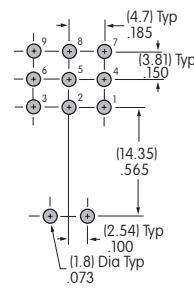
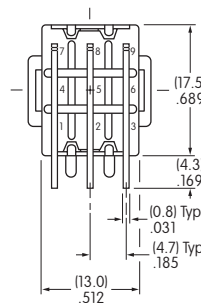
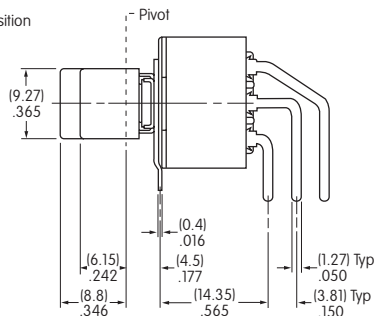
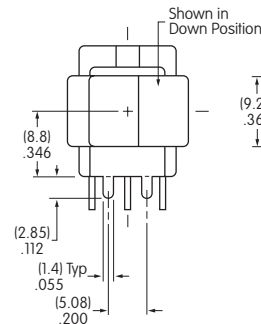

M2032TXG30-DC

## TYPICAL SWITCH DIMENSIONS

### .150" (3.81mm) Vertical PC

### Single Pole

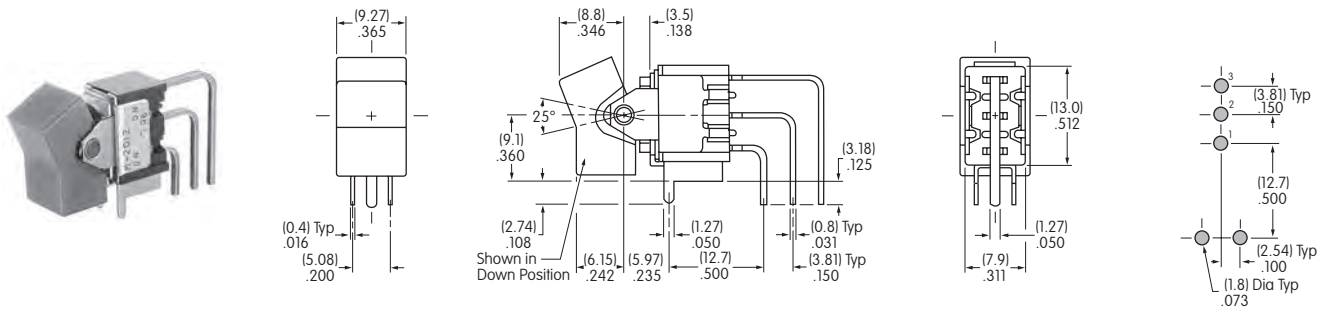

**M2012TXG41-DC**

### .150" (3.81mm) Vertical PC

### Double Pole

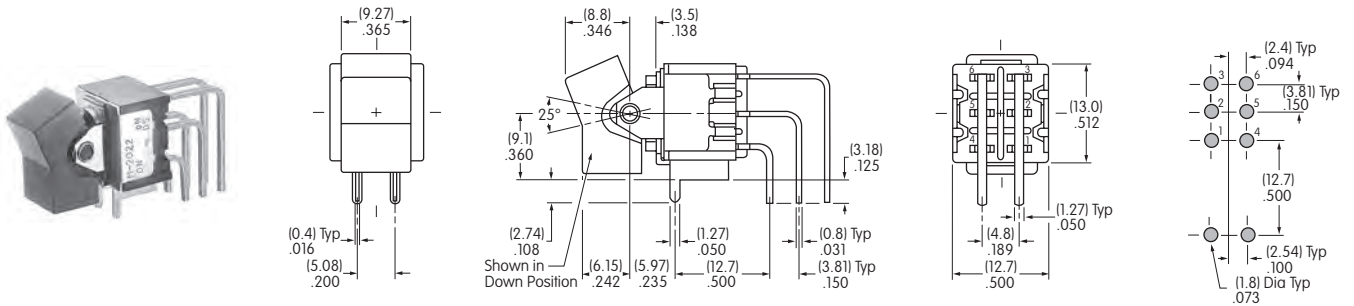

**M2022TXG41-DC**

### .150" (3.81mm) Vertical PC

### Three Pole

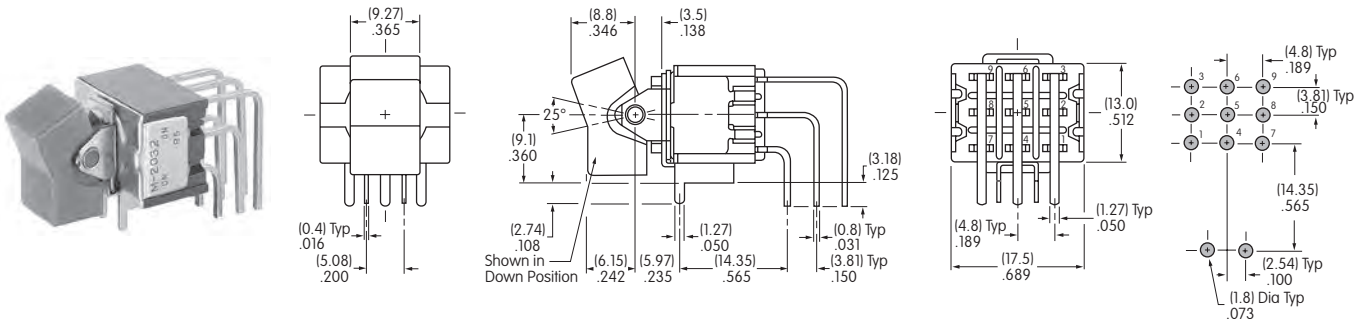

**M2032TXG41-DC**

### .150" (3.81mm) Vertical PC

### Four Pole

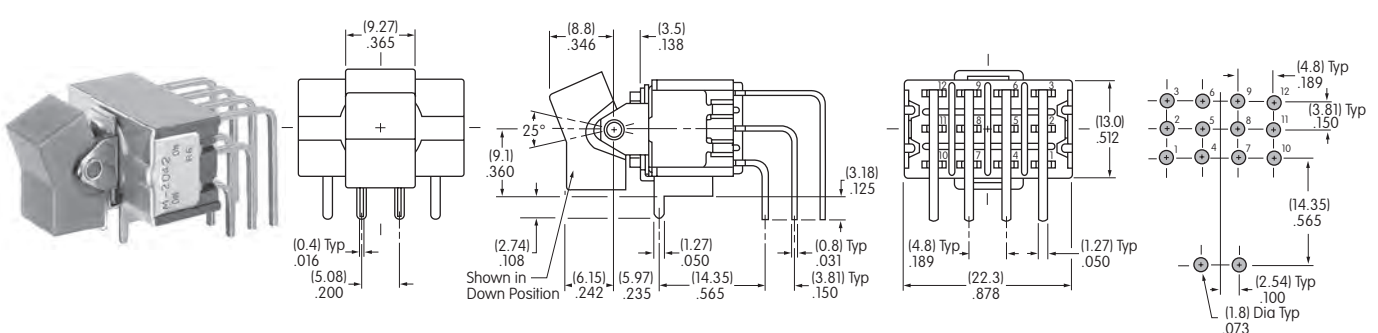

**M2042TXG41-DC**

Toggles

Rockers  
**B**

Pushbuttons

Illuminated PB

Programmable

Keylocks

Rotaries

Slides

Tactiles

Tilt

Touch

Indicators

Accessories

Supplement

TYPICAL SWITCH DIMENSIONS

Straight PC • Bracket

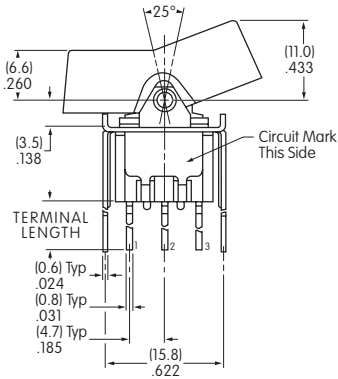

Single Pole

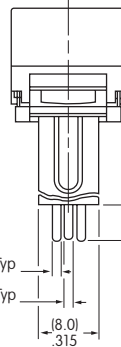

Double Pole

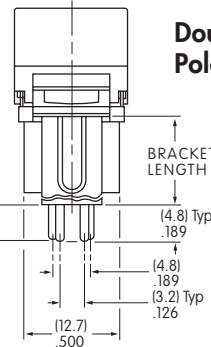

M2012TZG13-JC

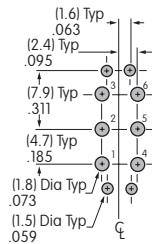
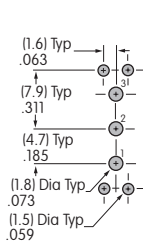

Terminal Code:	Terminal Length:	Bracket Length:
13	.250" (6.35mm)	.465" (11.8mm)
15	.425" (10.8mm)	.630" (16.0mm)
17	.964" (24.5mm)	1.150" (29.2mm)

Straight PC • Reinforced Bracket

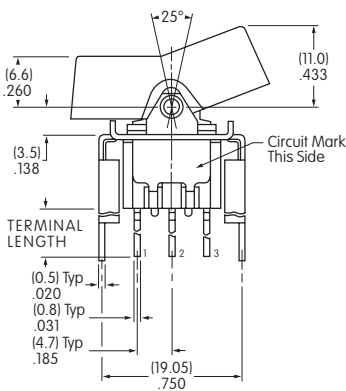

Single Pole

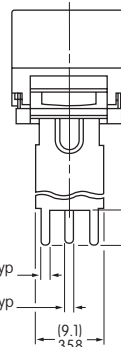

Double Pole

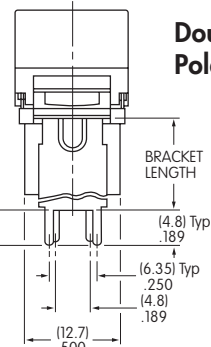

M2012TZG23-JC

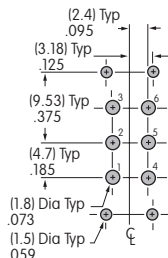
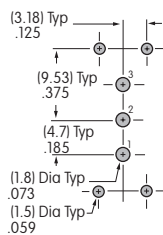

Terminal Code:	Terminal Length:	Bracket Length:
23	.250" (6.35mm)	.465" (11.8mm)
25	.425" (10.8mm)	.630" (16.0mm)
26	.750" (19.05mm)	.953" (24.2mm)

## LEGENDS

NKK Switches can provide custom legends for caps. Contact factory for more information.

### Suggested Printable Area for Cap

AT4148

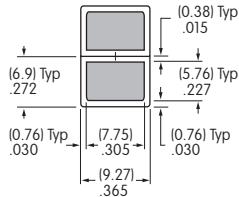

AT4150

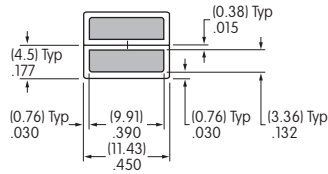

AT4156

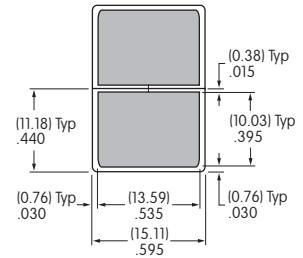

Shaded areas are printable areas.

### Recommended Print Method:

Pad Print

Epoxy based ink is recommended.



## TYPICAL SWITCH ORDERING EXAMPLE

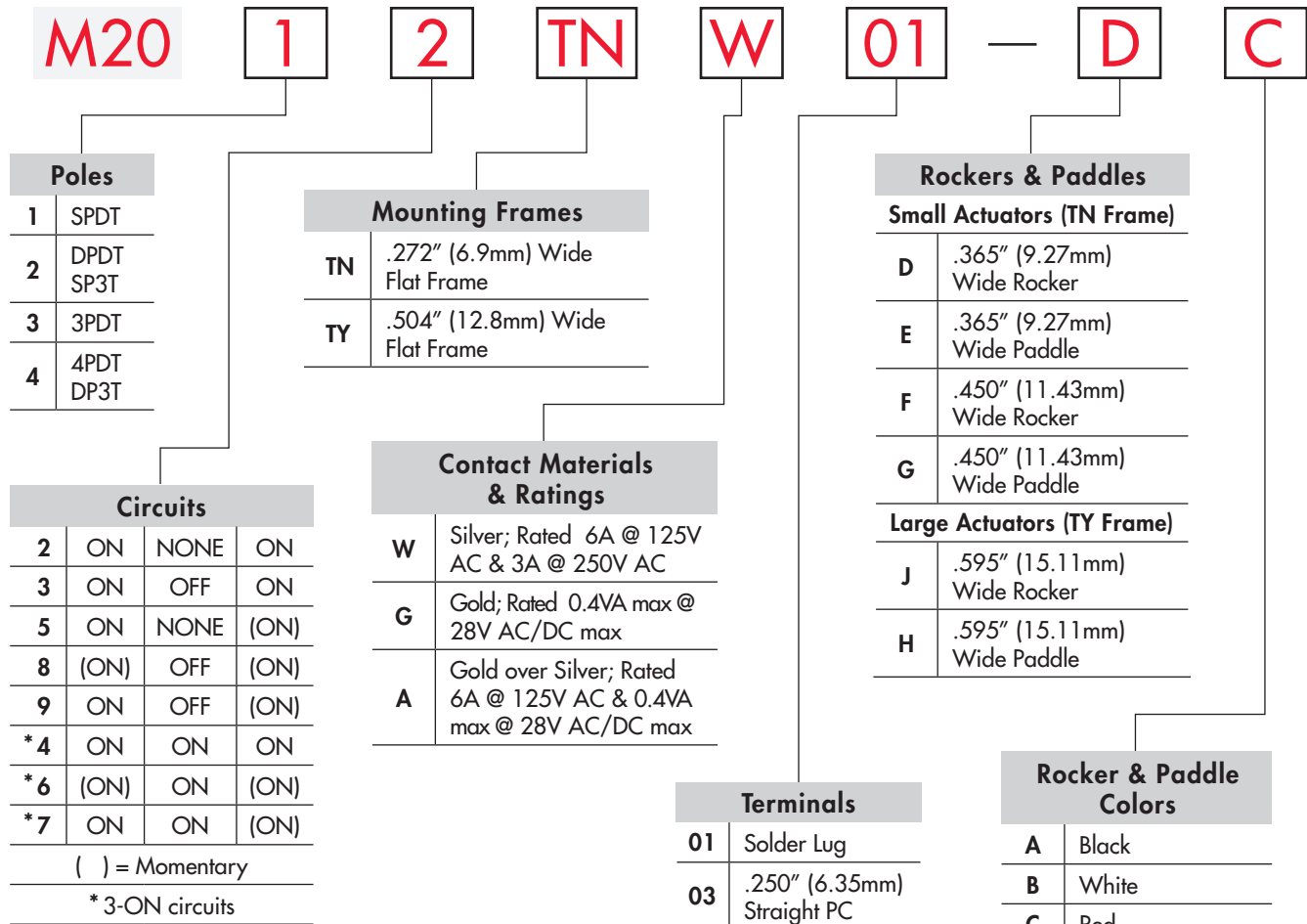

### IMPORTANT:



Switches are supplied without UL & CSA marking unless specified.  
**UL & CSA recognized only when ordered with marking on the switch.**  
 Specific models, ratings and ordering instructions are noted on the General Specifications page.

### DESCRIPTION FOR TYPICAL ORDERING EXAMPLE

#### M2012TNW01-DC



Toggle

Rockers **B**

Pushbuttons

Illuminated PB

Keylocks

Rotaries

Slides

Tactiles

Tilt

Touch

Indicators

Accessories

Supplement

## POLES & CIRCUITS

Pole	Model	Rocker Position ( ) = Momentary			Connected Terminals			Throw & Schematics
		Down	Center	Up	Down	Center	Up	
SP	M2012 M2013 M2015 M2018 M2019	ON ON ON (ON) ON	NONE OFF NONE OFF OFF	ON ON (ON) (ON) (ON)	2-3	OPEN	2-1	SPDT 
DP	M2022 M2023 M2025 M2028 M2029	ON ON ON (ON) ON	NONE OFF NONE OFF OFF	ON ON (ON) (ON) (ON)	2-3 5-6	OPEN	2-1 5-4	DPDT 
3P	M2032 M2033 M2035 M2038 M2039	ON ON ON (ON) ON	NONE OFF NONE OFF OFF	ON ON (ON) (ON) (ON)	2-3 5-6 8-9	OPEN	2-1 5-4 8-7	3PDT 
4P	M2042 M2043 M2045 M2048 M2049	ON ON ON (ON) ON	NONE OFF NONE OFF OFF	ON ON (ON) (ON) (ON)	2-3 5-6 8-9 11-12	OPEN	2-1 5-4 8-7 11-10	4PDT 

For 3 Throw (3-On)

### Connected Terminals & Schematics

Pole	Model	Down	Center	Up	Down	Center	Up
SP	M2024 M2026 M2027	ON (ON) ON	ON ON ON	ON (ON) (ON)	 2-3 5-6	 2-3 5-4	 2-1 5-4
DP	M2044 M2046 M2047	ON (ON) ON	ON ON ON	ON (ON) (ON)	 2-3 5-6 8-9 11-12	 2-3 5-4 8-9 11-10	 2-1 5-4 8-7 11-10

The SP3T model utilizes a double pole base.

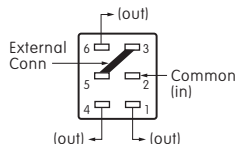

External connection must be made during field installation.

The DP3T model utilizes a four pole base.

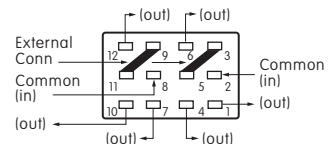

External connection must be made during field installation.

## MOUNTING FRAMES

**TN** .272" (6.9mm)  
Wide Flat Frame

Mounting hardware kit HK-1, as shown on the following page, must be ordered separately.

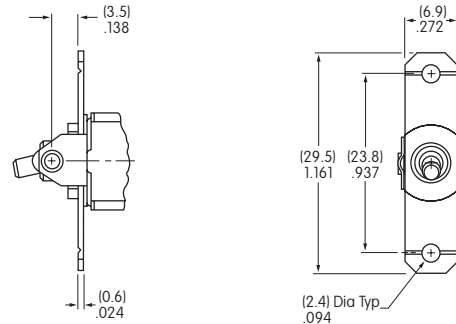

Small Actuators & Panel Cutouts for TN Frame (actuator details on the following pages)

AT4148

AT4149

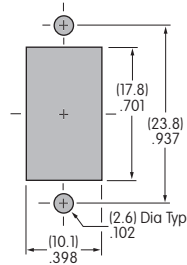
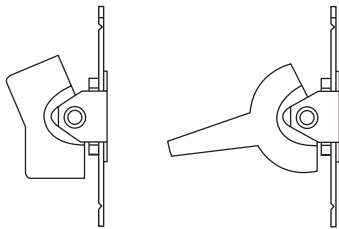

AT4150

AT4151

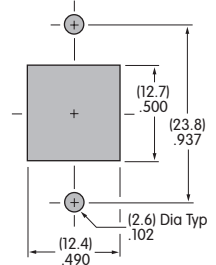
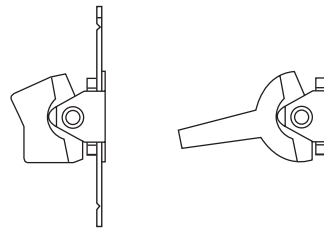

**TY** .504" (12.8mm)  
Wide Flat Frame

Large Actuators & Panel Cutout for TY Frame  
(actuator details on the following pages)

Mounting hardware kit HK-2, as shown on the following page, must be ordered separately.

AT4156

AT4157

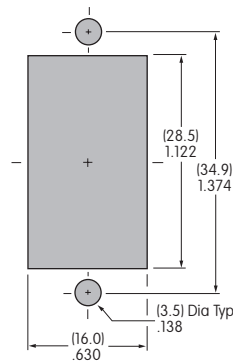
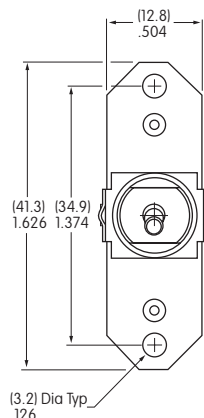
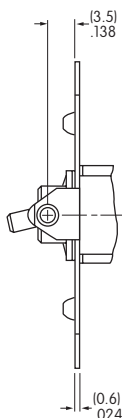
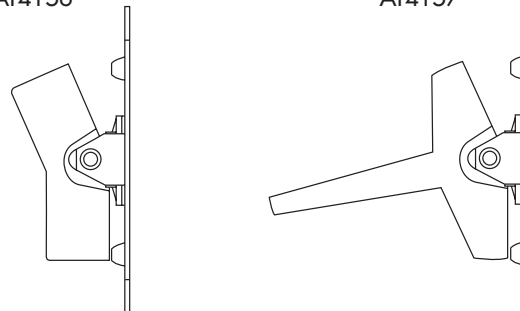

## MOUNTING FRAMES (CONTINUED)

### Face Panel Mounting

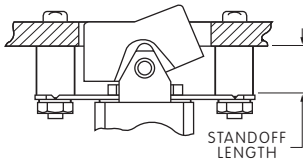

Flat frame devices may also be mounted to the face panel. Standoffs are used to recess the actuator and achieve an attractive front panel appearance.

### Subpanel Mounting

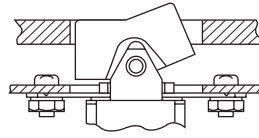

These devices are especially designed for subpanel mounting. When installed on a mounting plate behind the panel, hardware is completely concealed and the front panel retains a clean, attractive appearance.

### Optional Hardware Kits for Subpanel or Face Panel Mounting

Frame	Panel Thickness	Standoff Length	Hardware Kit Number
TN Frame	.125" (3.175mm)	.233" (5.918mm)	ATHK-1
TY Frame	.125" (3.175mm)	.312" (7.925mm)	ATHK-2

Hardware kits include:  
2 stainless steel screws, 2 hex nuts, 2 lockwashers, & 2 standoffs

### Optional Snap-in Panel Frames



AT064-1  
AT064-2

Further details are shown in the previous bracketed PC mount subsection.



AT065-1  
AT065-2

## CONTACT MATERIALS & RATINGS

**W**

Silver over Silver

Power Level

6A @ 125V AC & 3A @ 250V AC

**G**

Gold over Brass or Copper

Logic Level

0.4VA maximum @ 28V AC/DC maximum

Note: See Supplement section to find complete explanation of operating range.

**A**

Gold over Silver

Power Level  
or Logic Level

6A @ 125V AC  
or 0.4VA maximum @ 28V AC/DC maximum

Note: This dual rated option is suitable when two or more identical switches are used in logic and in power circuits within the same application. See Supplement section to find complete explanation of dual rating and operating range.

## TERMINALS

**01**

Solder Lug

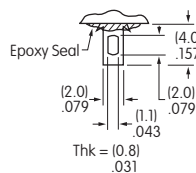

**03**

.250" (6.35mm)  
Straight PC

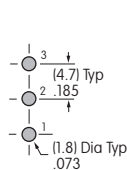
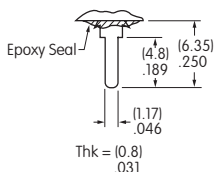

Single Pole

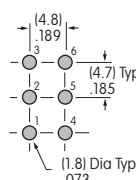

Double Pole

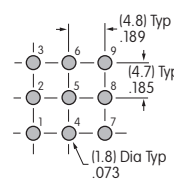

Three Pole

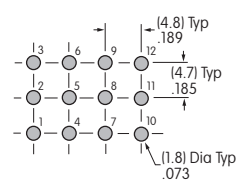

Four Pole

## ROCKERS & PADDLES

### For TN Frame

**D** AT4148 .365" (9.27mm)  
Wide Rocker

Material: Polyamide  
Finish: Matte

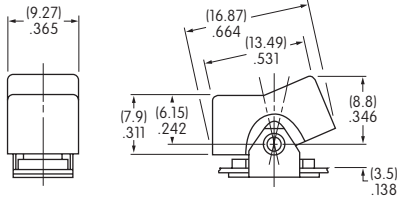

**E** AT4149 .365" (9.27mm)  
Wide Paddle

Material: Polyamide  
Finish: Matte

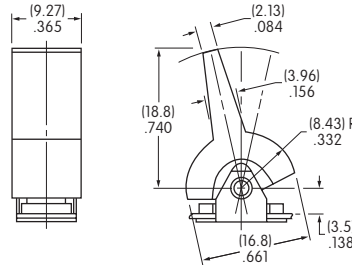

**F** AT4150 .450" (11.43mm)  
Wide Rocker

Material: Polyamide  
Finish: Matte

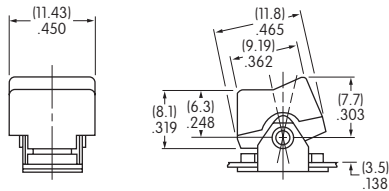

**G** AT4151 .450" (11.43mm)  
Wide Paddle

Material: Polyamide  
Finish: Matte

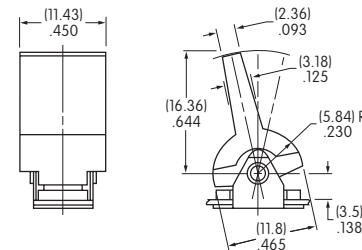

### For TY Frame

**J** AT4156 .595" (15.11mm)  
Wide Rocker

Material: Polyamide  
Finish: Matte

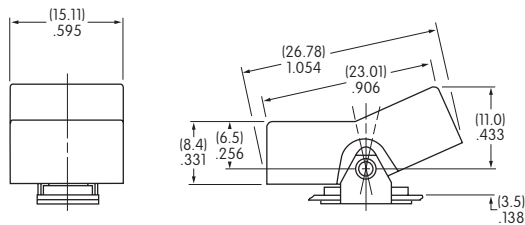

**H** AT4157 .595" (15.11mm)  
Wide Paddle

Material: Polyamide  
Finish: Matte

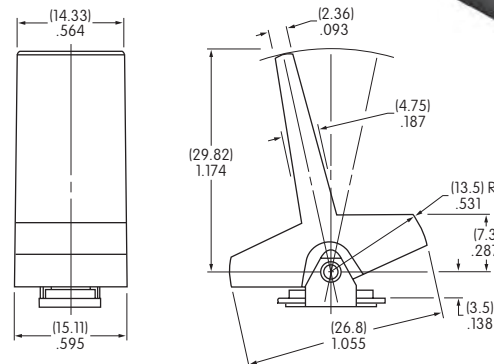

Cap Colors Available:

- A** Black
- B** White
- C** Red
- E** Yellow
- F** Green
- G** Blue
- H** Gray

## TYPICAL SWITCH DIMENSIONS

### TN Frame • Solder Lug

### Single Pole



M2012TNW01-DC

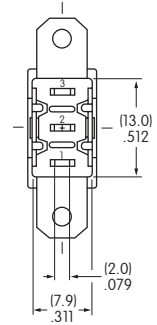
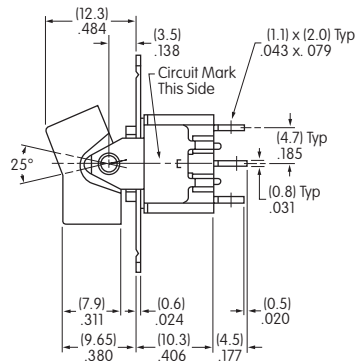
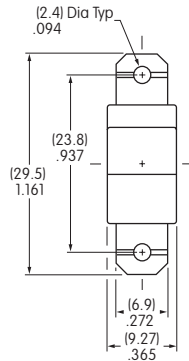

### TN Frame • Solder Lug

### Double Pole



M2022TNW01-DC

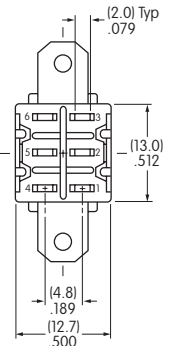
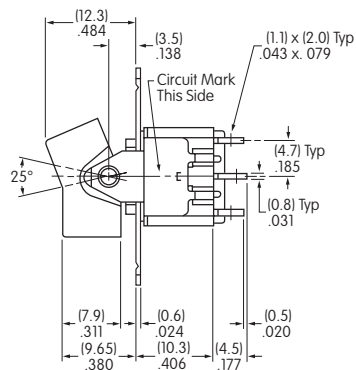
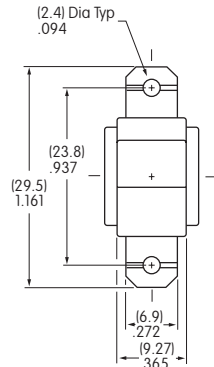

### TN Frame • Solder Lug

### Three Pole



M2032TNW01-DC

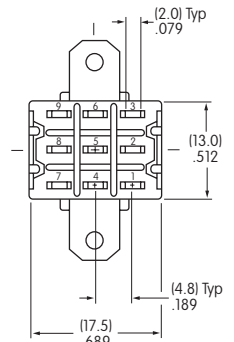
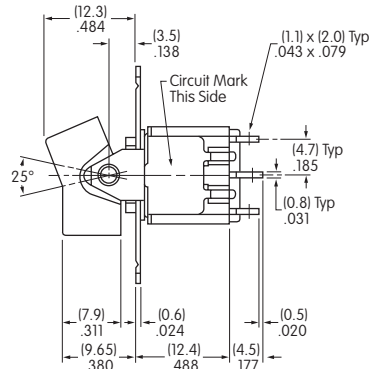
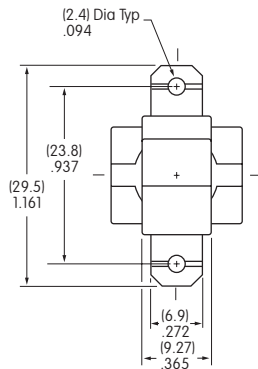

### TN Frame • Solder Lug

### Four Pole



M2042TNW01-DC

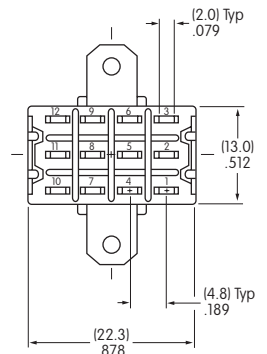
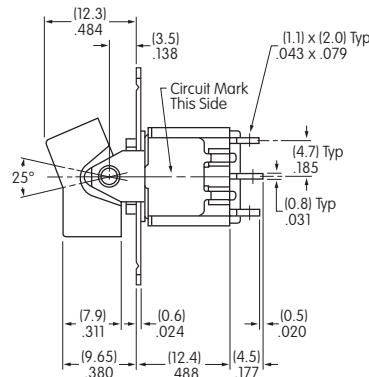
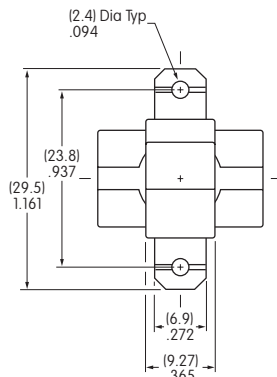

Toggle

Rockers  
B

Pushbuttons

Illuminated PB

Programmable

Keylocks

Rotaries

Slides

Tactiles

Tilt

Touch

Indicators

Accessories

Supplement

## TYPICAL SWITCH DIMENSIONS

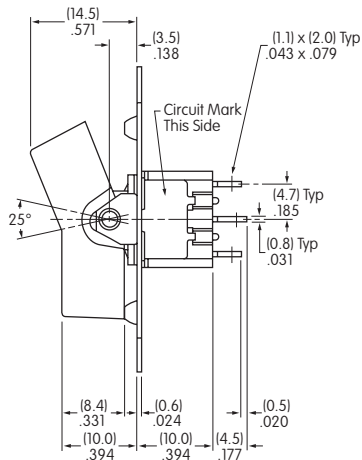
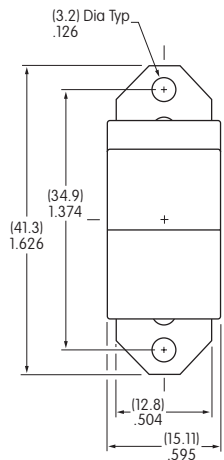

Single Pole

Double Pole

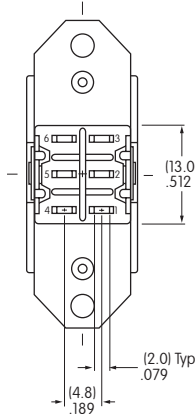
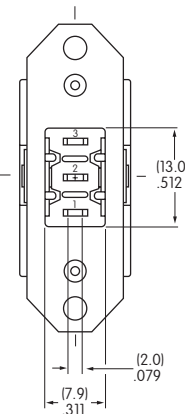

Double pole has barrier between terminals.

TY Frame • Solder Lug



M2012TYW01-JC

Three Pole

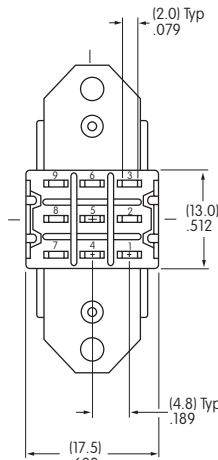
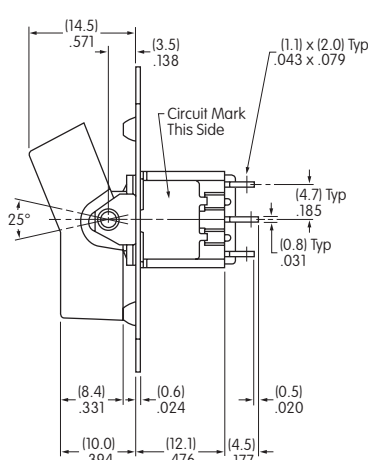
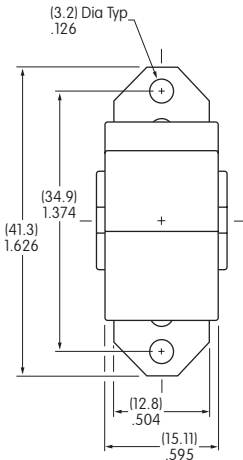

TY Frame • Solder Lug



M2032TYW01-JC

Four Pole

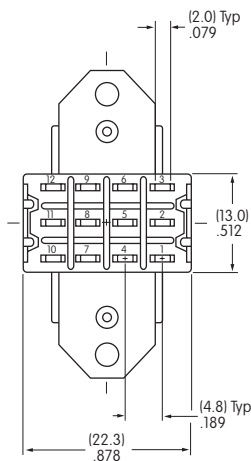
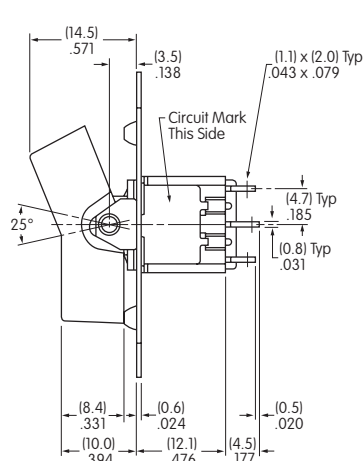
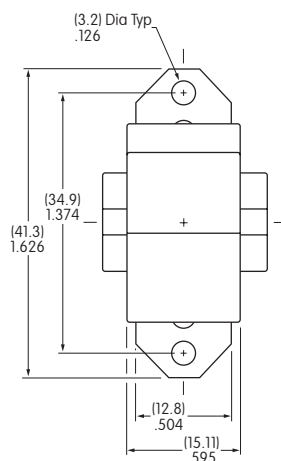

TY Frame • Solder Lug



M2042TYW01-JC

## LEGENDS

NKK Switches can provide custom legends for caps. Contact factory for more information.

### Suggested Printable Area for Caps

AT4148

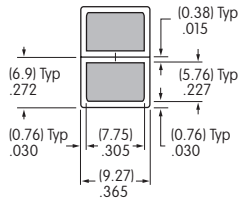

AT4150

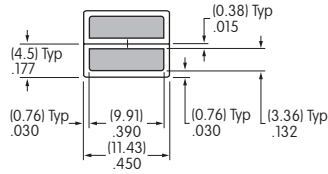

AT4156

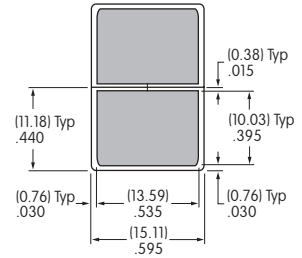

Shaded areas are printable areas.

### Recommended Print Method:

Pad Print

Epoxy based ink is recommended.

Toggles

Rockers  
B

Pushbuttons

Illuminated PB

Programmable

Keylocks

Rotaries

Slides

Tactiles

Tilt

Touch

Indicators

Accessories

Supplement





# General Specifications

Toggles

Rockers

Pushbuttons

Illuminated PB

Programmable

Keylocks

Rotaries

Slides

Tactiles

Tilt

Touch

Indicators

Accessories

Supplement

## B Electrical Capacity (Resistive Load)

**Power Level (silver):** 6A @ 125V AC or 3A @ 250V AC or 3A @ 30V DC  
**Logic Level (gold):** 0.4VA maximum @ 28V AC/DC maximum  
 (Applicable Range 0.1mA ~ 0.1A @ 20mV ~ 28V)  
 Note: Find additional explanation of operating range in Supplement section.

## Other Ratings

**Contact Resistance:** 10 milliohms maximum for silver; 20 milliohms maximum for gold  
**Insulation Resistance:** 1,000 megohms minimum @ 500V DC  
**Dielectric Strength:** 1,000V AC minimum between contacts for 1 minute minimum;  
 1,500V AC minimum between contacts & case for 1 minute minimum  
**Mechanical Life:** 50,000 operations minimum  
**Electrical Life:** 25,000 operations minimum

Nominal Operating Force:		On-to-On Position		Off-to-On Position	
Paddles	Single Pole	3.19N	3.92N		
	Double Pole	4.41N	7.06N		
Rockers	Single Pole	6.37N	9.80N		
	Double Pole	13.73N	17.65N		

**Angle of Throw:** 20°

## Materials & Finishes

**Housing:** Stainless steel  
**Mounting Bracket:** Stainless steel  
**Movable Contacts:** Silver alloy or silver alloy with gold plating  
**Stationary Contacts:** Silver with silver plating or copper or brass with gold plating  
**Lamp Contacts:** Phosphor bronze  
**Base:** Diallyl phthalate (UL94V-0)  
**Switch Terminals:** Copper with silver or gold plating  
**Lamp Terminals:** Brass with silver or gold plating

## Environmental Data

**Operating Temp Range:** -10°C through +55°C (+14°F through +131°F) for rockers  
 -25°C through +70°C (-13°F through +158°F) for paddles  
**Humidity:** 90 ~ 95% humidity for 96 hours @ 40°C (104°F)  
**Vibration:** 10 ~ 55Hz with peak-to-peak amplitude of 1.5mm traversing the frequency range & returning in 1 minute; 3 right angled directions for 2 hours  
**Shock:** 50G (490m/s<sup>2</sup>) acceleration (tested in 6 right angled directions, with 5 shocks in each direction)

## Installation

**Soldering Time & Temp:** Wave Soldering (PC version): See Profile B in Supplement section.  
 Manual Soldering: See Profile B in Supplement section.  
 Note: Lever must be in center position while soldering.  
**Cleaning:** PC mountable device is not process sealed. Hand clean locally using alcohol based solution.

## Standards & Certifications

**Flammability Standards:** UL94V-0 base  
**UL:** **File No. E44145 - Recognized only when ordered with marking on switch.**  
 Add "/U" before dash in part number to order UL recognized switch.  
 Single pole rockers with synchronous circuits & single color LEDs & solder lug or PC recognized at 6A @ 125V AC.  
**CSA:** **File No. 023535\_0\_000 - Certified only when ordered with marking on switch.**  
 Add "/C" before dash in part number to order CSA certified switch.  
 All single pole rockers with synchronous circuits & single color LEDs certified at 6A @ 125V AC.

## TYPICAL SWITCH ORDERING EXAMPLE

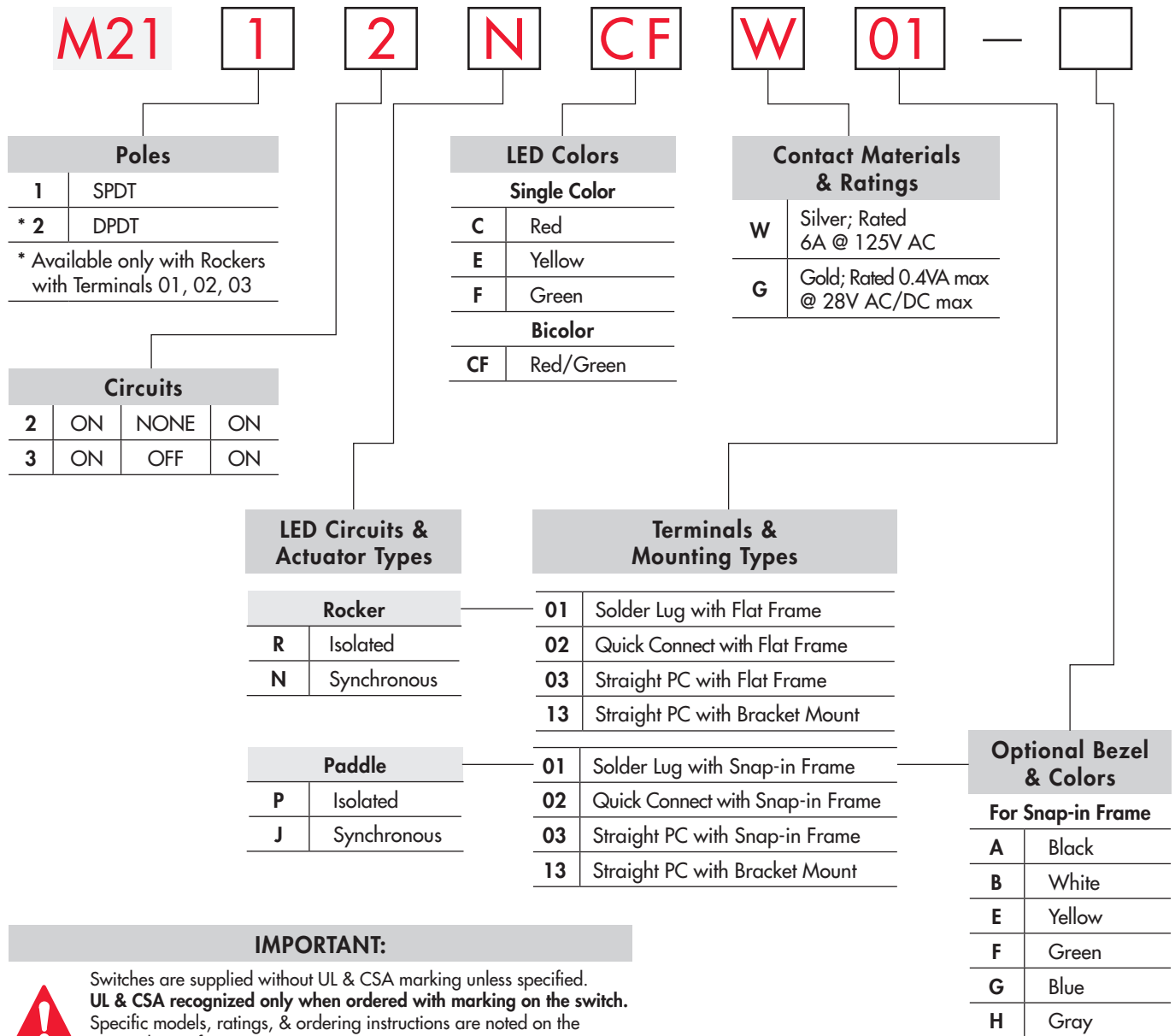

### IMPORTANT:











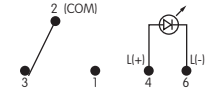
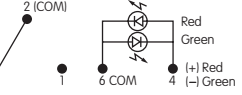
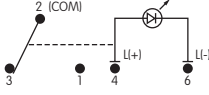
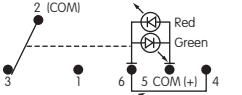

Switches are supplied without UL & CSA marking unless specified.  
**UL & CSA recognized only when ordered with marking on the switch.**  
 Specific models, ratings, & ordering instructions are noted on the General Specifications page.

### DESCRIPTION FOR TYPICAL ORDERING EXAMPLE

#### M2112NCFW01

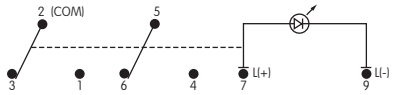

## POLES & CIRCUITS & LED ILLUMINATION

Model	Pole & Throw	Toggle Position & Terminal Numbers			Schematics
		Down 	Center 	Up 	
<b>M2112</b>	<b>SPDT</b>	ON	NONE	ON	Notes: Terminal numbers are not actually on the switch. LEDs require an external power source.  Isolated Single Color LED  Isolated Bicolor LED  Synchronous Single Color LED  Synchronous Bicolor LED 
Connected Power Terminals		2-3	NONE	2-1	
<b>LED Circuit</b>	<b>Isolated LEDs</b> (see schematics) Connected LED Terminals <b>Synchronous Single Color LED</b> Connected LED Terminals <b>Synchronous Bicolor LED</b> Connected LED Terminals	ON 4-6	NONE NONE	ON 4-6	
<b>M2113</b>	<b>SPDT</b>	ON	OFF	ON	Synchronous Single Color LED  Synchronous Bicolor LED 
Connected Power Terminals		2-3	OPEN	2-1	
<b>LED Circuit</b>	<b>Isolated LEDs</b> (see schematics) Connected LED Terminals <b>Synchronous Single Color LED</b> Connected LED Terminals <b>Synchronous Bicolor LED</b> Connected LED Terminals	ON 4-6	ON OFF	ON 4-6	
<b>M2122</b>	<b>DPDT</b>	ON	NONE	ON	Isolated Single Color LED  Isolated Bicolor LED  Synchronous Single Color LED  Synchronous Bicolor LED 
Connected Power Terminals		2-3 5-6	NONE	2-1 5-4	
<b>LED Circuit</b>	<b>Isolated LEDs</b> (see schematics) Connected LED Terminals <b>Synchronous Single Color LED</b> Connected LED Terminals <b>Synchronous Bicolor LED</b> Connected LED Terminals	ON 7-9	NONE NONE	ON 7-9	
<b>M2123</b>	<b>DPDT</b>	ON	OFF	ON	Synchronous Single Color LED  Synchronous Bicolor LED 
Connected Power Terminals		2-3 5-6	OPEN	2-1 5-4	
<b>LED Circuit</b>	<b>Isolated LEDs</b> (see schematics) Connected LED Terminals <b>Synchronous Single Color LED</b> Connected LED Terminals <b>Synchronous Bicolor LED</b> Connected LED Terminals	ON 7-9	ON OFF	ON 7-9	

## LED COLORS & SPECIFICATIONS

The electrical specifications shown are determined at a basic temperature of 25°C. LED circuit is isolated and requires an external power source. If the source voltage exceeds the rated voltage, a ballast resistor is required. The resistor value can be calculated by using the formula in Supplement Section. The LED is an integral part of the switch and not available separately. Bicolor LED is translucent white when unlit.

		Rockers				Paddles				Units
		Single Color		Bicolor	Single Color		Bicolor			
		C	E	F	CF	C	E	F	CF	
		Red	Yellow	Green	Red/Green	Red	Yellow	Green	Red/Green	
Maximum Forward Current	$I_{FM}$	25	30	30	25	25	30	25	30/25	mA
Typical Forward Current	$I_F$	20	20	20	20	20	20	20	20/20	mA
Forward Voltage	$V_F$	2.1	2.1	2.1	1.7/2.0	2.25	2.1	2.2	2.0/2.2	V
Maximum Reverse Voltage	$V_{RM}$	4	4	4	—	5	5	5	—	V
Current Reduction Rate Above 25°C	$\Delta I_F$	0.33	0.40	0.40	0.33/0.33	0.33	0.40	0.33	0.43/0.38	mA/°C
Ambient Temperature Range		-10° ~ +55°C				-25° ~ +50°C			-25° ~ +70°C	

## LED CIRCUIT, ROCKER, & MOUNTING TYPE COMBINATIONS

**R** Rocker with Isolated LED Circuit

**N** Rocker with Synchronous LED Circuit

Material: Polyamide

Finish: Matte

Color: Black

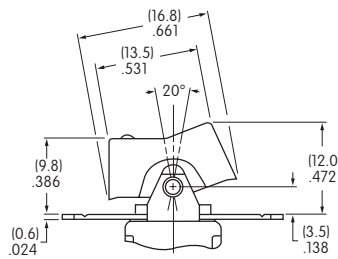

Flat Frame combines with Terminal codes 01, 02, & 03.

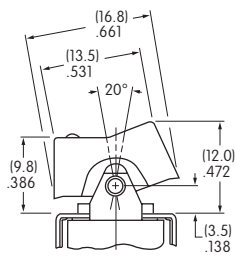

Bracket combines with Terminal code 13.

Maximum Panel Thickness .126" (3.2mm)

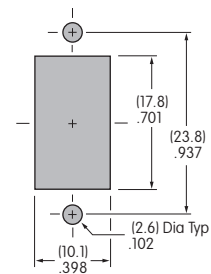

## TYPICAL ROCKER SWITCH DIMENSIONS

### Single Pole

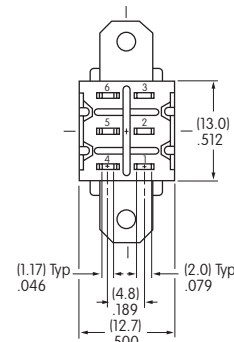
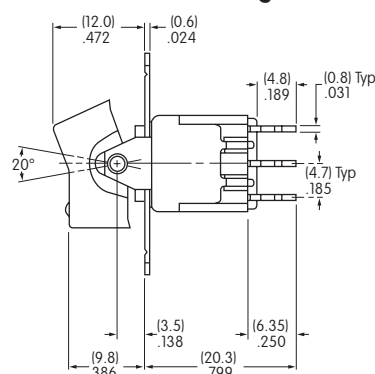
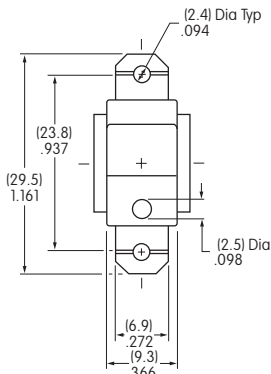

Single color LED switch does not have terminal 5.

### Solder Lug



**M2112NCFW01**

### Double Pole

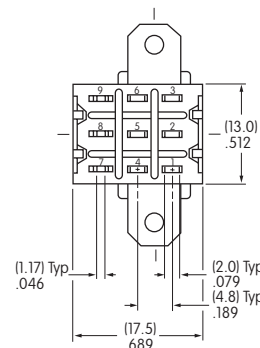
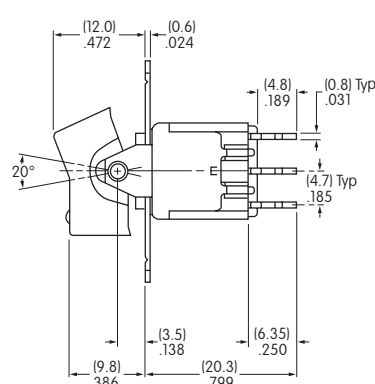
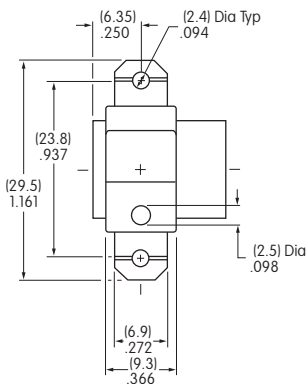

Single color LED switch does not have terminal 8.

### Solder Lug



**M2122NCFW01**

### Single Pole Only

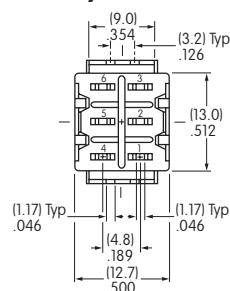
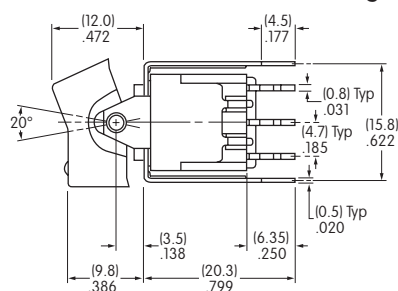
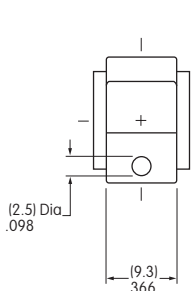

Single color LED switch does not have terminal 5. Silver contact material is standard.

### Straight PC • Bracket

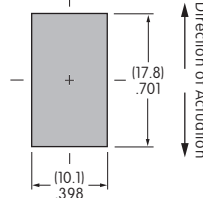

**M2112NCFW13**

## LED CIRCUIT, PADDLE, & MOUNTING TYPE COMBINATIONS

**P** Paddle with Isolated LED Circuit

**J** Paddle with Synchronous LED Circuit

Maximum Panel Thickness  
.039" ~ .126" (1.0 ~ 3.2mm)  
without Bezel

Maximum Panel Thickness  
.039" ~ .098" (1.0 ~ 2.5mm)  
with Bezel

Maximum Panel Thickness  
1.26" (3.2mm)

Material: Polyamide  
Finish: Matte  
Color: Black

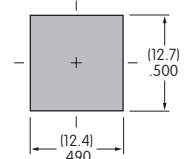
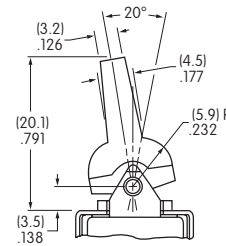
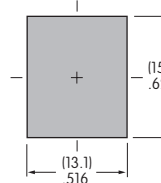
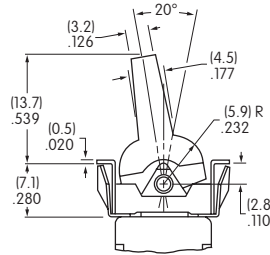

Snap-in combines with Terminal codes 01, 02, & 03

Bracket combines with Terminal code 13

## TYPICAL PADDLE SWITCH DIMENSIONS

Solder Lug • Snap-in

Single Pole Only

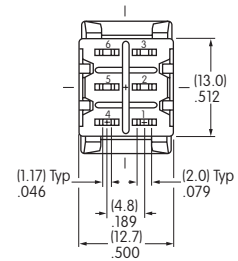
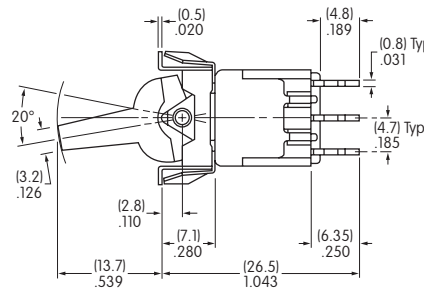
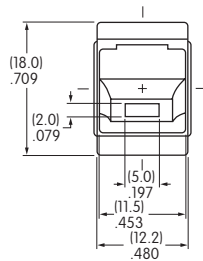

**M2112JCFW01**

Single color LED switch does not have terminal 5.

Straight PC • Bracket

Single Pole Only

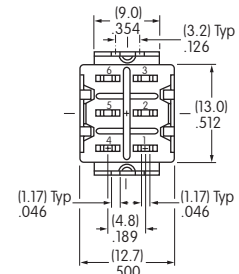
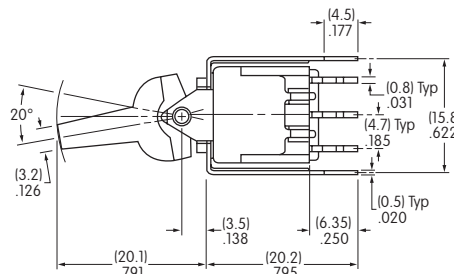
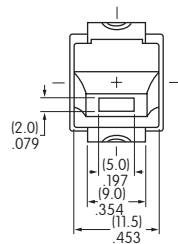

**M2112JCFW13**

Silver contact material is standard. Single color LED switch does not have terminal 5.

## CONTACT MATERIALS & RATINGS

**W** Silver over Silver Power Level 6A @ 125V AC & 3A @ 250V AC

**G** Gold over Brass or Copper Logic Level 0.4VA maximum @ 28V AC/DC maximum  
 Complete explanation of operating range in Supplement section.

## TERMINALS

**01** Solder Lug with Turret LED Terminal

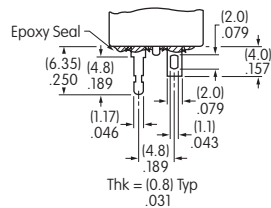

**02** Quick Connect

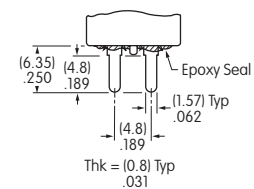

**03** Straight PC with Turret LED Terminal

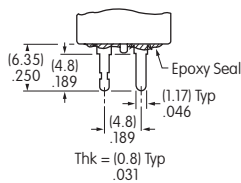

Single Pole

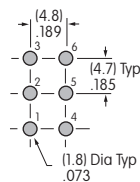

Single color LED & isolated bicolor LED switches do not have terminal 5.

Double Pole

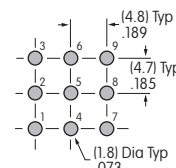

Single color LED & isolated bicolor LED switches do not have terminal 8.

**13** Straight PC with Bracket & Turret LED Terminal

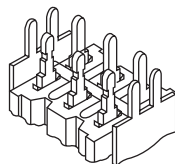

Single Pole

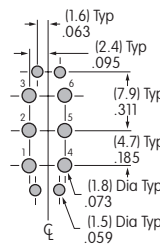

Single color LED & isolated bicolor LED switches do not have terminal 5.

## OPTIONAL BEZEL & COLORS

AT2107 Bezel for Snap-in Panel Frame

Material: Polyamide

Finish: Matte

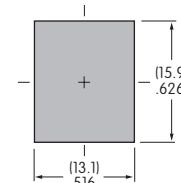
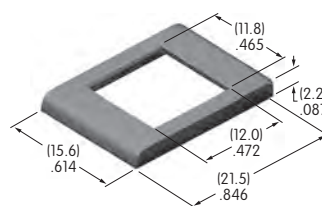

Colors Available:

- A** Black
- B** White
- E** Yellow
- F** Green
- G** Blue
- H** Gray

# General Specifications

Toggles

Rockers  
B

Pushbuttons

Illuminated PB

Programmable

Keylocks

Rotaries

Slides

Tactiles

Tilt

Touch

Indicators

Accessories

Supplement

## Electrical Capacity (Resistive Load)

**Power Level (silver):** 6A @ 125V AC or 3A @ 250V AC;  
4A @ 30V DC (On-On circuit) & 3A @ 30V DC (all other circuits)

**Logic Level (gold):** 0.4VA maximum @ 28V AC/DC maximum  
(Applicable Range 0.1mA ~ 0.1A @ 20mV ~ 28V)

**Logic/Power Level (gold over silver):** Combines silver & gold ratings

Note: Find additional explanation of dual rating & operating range in Supplement section.

## Other Ratings

**Contact Resistance:** 10 milliohms maximum for silver; 20 milliohms maximum for gold

**Insulation Resistance:** 1,000 megohms minimum @ 500V DC

**Dielectric Strength:** 1,000V AC minimum between contacts for 1 minute minimum;  
1,500V AC minimum between contacts & case for 1 minute minimum

**Mechanical Life:** 50,000 operations minimum

**Electrical Life:** 25,000 operations minimum for silver; 50,000 operations minimum for gold

**Contact Timing:** Nonshorting (break-before-make)

**Angle of Throw:** 26°

## Materials & Finishes

**Lever:** Brass with nickel plating

**Actuator Clip:** Polyacetal

**Support Bracket:** Brass with tin plating

**Bushing/Housing:** Glass fiber reinforced polyamide (UL94V-0)

**Sealing Ring:** Nitrile butadiene rubber

**Base:** Glass fiber reinforced polyamide (UL94V-0)

**Movable Contacts:** Silver alloy with silver plating (code W); copper or phosphor bronze with gold plating (code G);  
or silver alloy with gold plating (code A)

**Stationary Contacts:** Silver alloy with silver plating (code W); copper or brass with gold plating (code G);  
or silver alloy with gold plating (code A)

**Terminals:** Copper or brass with silver or gold plating

## Environmental Data

**Operating Temp Range:** -30°C through +85°C (-22°F through +185°F)

**Humidity:** 90 ~ 95% humidity for 96 hours @ 40°C (104°F)

**Vibration:** 10 ~ 55Hz with peak-to-peak amplitude of 1.5mm traversing the frequency range & returning  
in 1 minute; 3 right angled directions for 2 hours

**Shock:** 50G (490m/s<sup>2</sup>) acceleration (tested in 6 right angled directions, with 5 shocks in each direction)

## PCB Processing

**Soldering:** Wave Soldering Recommended: See Profile B in Supplement section.

Manual Soldering: See Profile B in Supplement section.

**Cleaning:** Automated cleaning. See Cleaning specifications in Supplement section.

## Standards & Certifications

**Flammability Standards:** UL94V-0 rated bushing/housing & base

**UL:** File No. E44145 - Recognized only when ordered with marking on switch.

Add "/U" or "/CUL" before dash in part number to order UL recognized switch.

All models recognized at 6A @ 125V AC, 3A @ 250V AC, & 4A @ 30V DC or 0.4A @ 28V DC.

**CSA:** File No. 023535\_0\_000 - Certified only when ordered with marking on switch.

Add "/C" before dash in part number to order CSA certified switch.

All models certified at 6A @ 125V AC, 3A @ 250V AC, & 4A @ 30V DC.



# Distinctive Characteristics

Antijamming design protects against mechanism damage from downward force on the actuator.

O-ring surrounding top of lever prevents liquids from reaching switch mechanism.

Ultrasonic welding of upper and lower housing seals out contaminants and allows automated soldering and cleaning.

Terminals are epoxy sealed to prevent entry of flux, solvents, and other contaminants.

Bracketed models have crimped bracket legs to ensure secure PC mounting and prevent dislodging during automated soldering.

Logic level and power capabilities are available to suit varying applications.

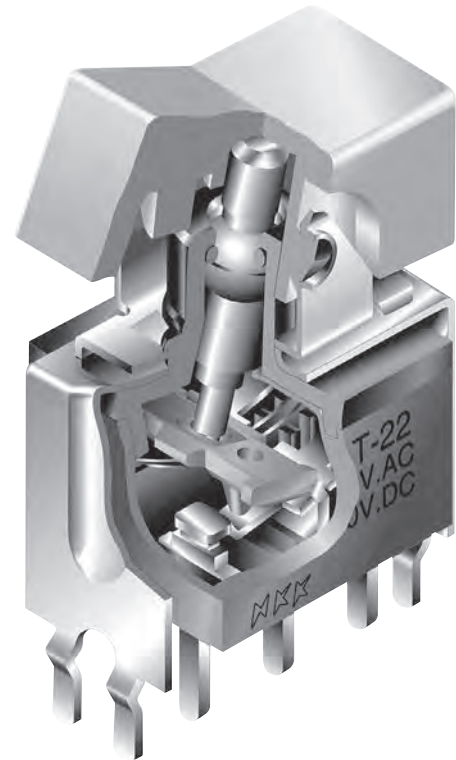

Actual Size

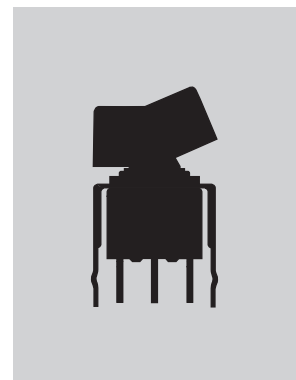

Toggle

**B** Rockers

Pushbuttons

Illuminated PB

Programmable

Key locks

Rotaries

Slides

Tactiles

Tilt

Touch

Indicators

Accessories

Supplement

### TYPICAL SWITCH ORDERING EXAMPLE

**M2T**

**2**

**2**

**TX**

**G**

**41**

**D**

**C**

#### Poles

1	SPDT
2	DPDT

#### Circuits

2	ON	NONE	ON
3	ON	OFF	ON
5	ON	NONE	(ON)
8	(ON)	OFF	(ON)
9	ON	OFF	(ON)

( ) = Momentary

#### Mounting Frame

TX	For Actuators with Straight or Angle PC Mount
----	---

#### Contact Materials & Ratings

W	Silver; Rated 6A @ 125V AC & 3A @ 250V AC
G	Gold; Rated 0.4VA max @ 28V AC/DC max
A	Gold over Silver; Rated 6A @ 125V AC & 0.4VA max @ 28V AC/DC max

#### PC Terminals

13	Straight with .460" (11.7mm) Bracket
30	.150" (3.81mm) Right Angle
41	.150" (3.81mm) Vertical

#### Rockers/Paddles

D	.365" (9.27mm) Wide Rocker
E	.365" (9.27mm) Wide Paddle
F	.450" (11.43mm) Wide Rocker
G	.450" (11.43mm) Wide Paddle

#### Rocker/Paddle Colors

A	Black
B	White
C	Red
E	Yellow
F	Green
G	Blue
H	Gray

#### IMPORTANT:



Switches are supplied without UL, cULus & CSA marking unless specified.  
**UL, cULus & CSA recognized only when ordered with marking on the switch.**  
 Specific models, ratings and ordering instructions are noted on the General Specifications page.

#### DESCRIPTION FOR TYPICAL ORDERING EXAMPLE

**M2T2TXG41-DC**

Mounting Frame for Actuators with Straight or Angle PC Mount

.365" (9.27mm) Wide Red Rocker

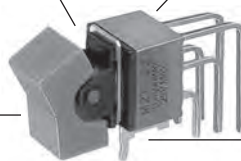

DPDT ON-NONE-ON Circuit

.150" (3.81mm) Vertical Terminals

Gold Contacts with 0.4VA Rating

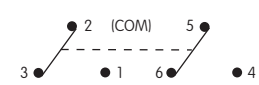
POLES & CIRCUITS								
Pole	Model	Rocker Position ( ) = Momentary			Connected Terminals			Throw & Schematics
		Down	Center	Up	Down	Center	Up	
SP	M2T12 M2T13 M2T15 M2T18 M2T19	ON ON ON (ON) ON	NONE OFF NONE OFF OFF	ON ON (ON) (ON) (ON)	2-3	OPEN	2-1	Note: Terminal numbers are not actually on the switch.  SPDT 
DP	M2T22 M2T23 M2T25 M2T28 M2T29	ON ON ON (ON) ON	NONE OFF NONE OFF OFF	ON ON (ON) (ON) (ON)	2-3 5-6	OPEN	2-1 5-4	DPDT 

## MOUNTING FRAME

**TX**

Mounting Frame for Rockers or Paddles with Straight or Angle PC Terminals

Straight PC Mounting

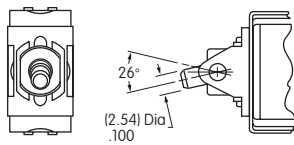

Right Angle PC Mounting

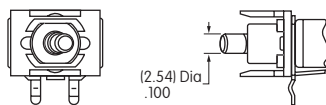

Vertical PC Mounting

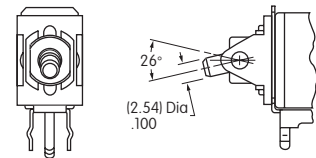

Actuators & Panel Cutouts

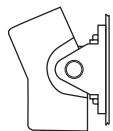

AT4148

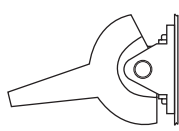

AT4149

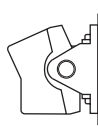
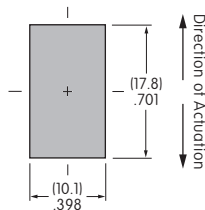

AT4150

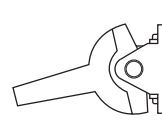

AT4151

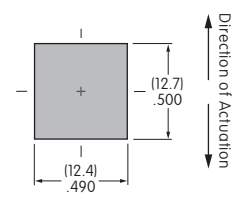

## CONTACT MATERIALS & RATINGS

**W**

Silver over Silver

Power Level

6A @ 125V AC & 3A @ 250V AC

**G**

Gold over Brass or Copper

Logic Level

0.4VA maximum @ 28V AC/DC maximum

Complete explanation of operating range in Supplement section.

**A**

Gold over Silver

Power Level  
or Logic Level

6A @ 125V AC  
or 0.4VA maximum @ 28V AC/DC maximum

Note: This dual rated option is suitable when two or more identical switches are used in logic and in power circuits within the same application. See Supplement section for complete explanation of dual rating and operating range.

Toggle

Rockers **B**

Pushbuttons

Illuminated PB

Programmable

Keylocks

Rotaries

Slides

Tactiles

Tilt

Touch

Indicators

Accessories

Supplement

## PC TERMINALS

**13** Straight with  
.460" (11.7mm)  
Bracket

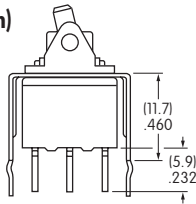

**30** .150" (3.81mm)  
Right Angle

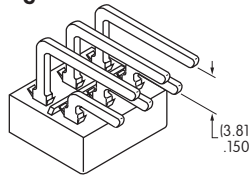

**41** .150" (3.81mm)  
Vertical

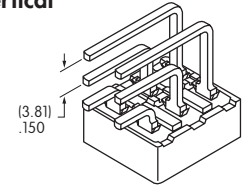

## ROCKERS & PADDLES

**D** AT4148  
.365" (9.27mm) Wide Rocker

Material: Polyamide  
Finish: Matte

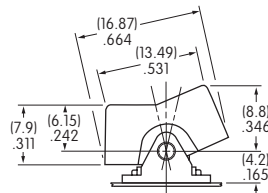
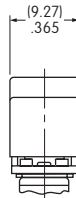

**E** AT4149  
.365" (9.27mm) Wide Paddle

Material: Polyamide  
Finish: Matte

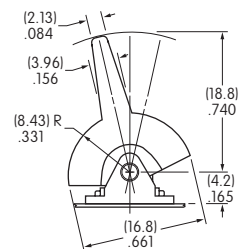

**F** AT4150  
.450" (11.43mm) Wide Rocker

Material: Polyamide  
Finish: Matte

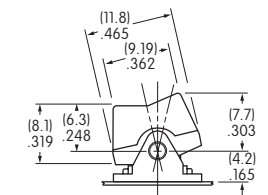
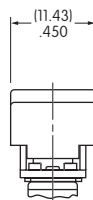

**G** AT4151  
.450" (11.43mm) Wide Paddle

Material: Polyamide  
Finish: Matte

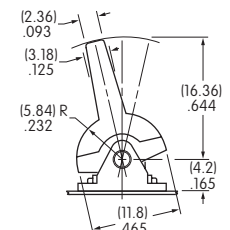

Cap Colors  
Available:

**A** Black

**B** White

**C** Red

**E** Yellow

**F** Green

**G** Blue

**H** Gray

## TYPICAL SWITCH DIMENSIONS

Straight PC • Bracket

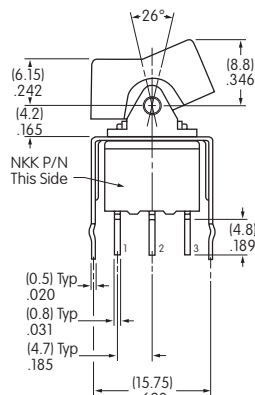

Single Pole

Double Pole

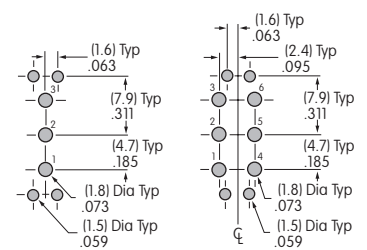
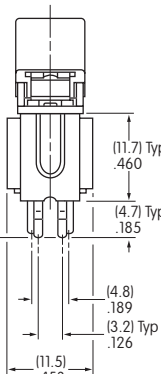
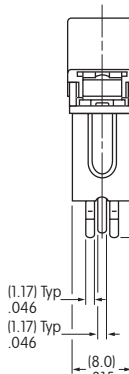

M2T12TXG13-DC

TYPICAL SWITCH DIMENSIONS

Single Pole

Right Angle PC

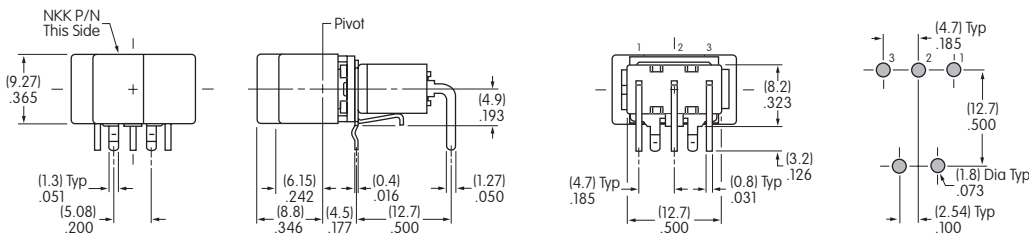

M2T12TXG30-DC

Double Pole

Right Angle PC

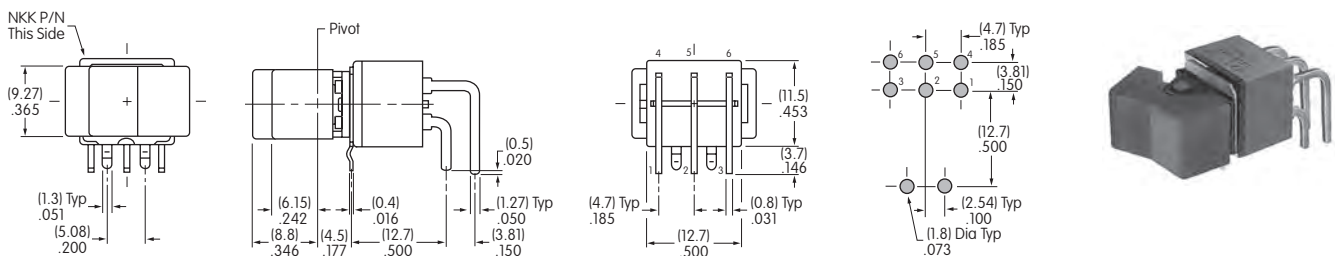

M2T22TXG30-DC

Single Pole

Vertical PC

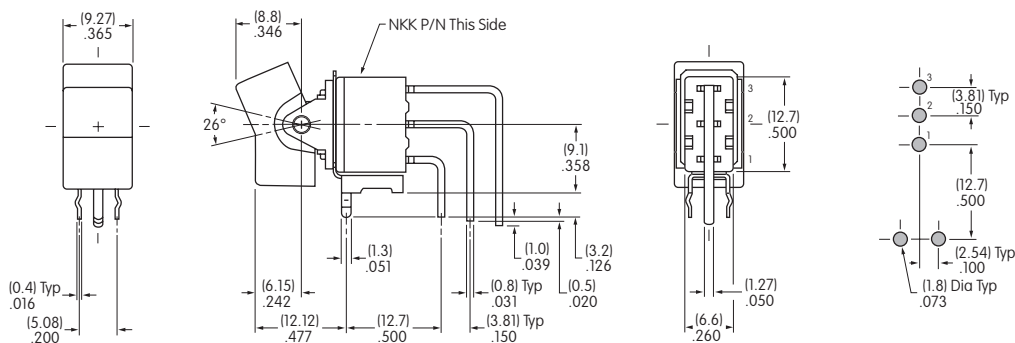

M2T12TXG41-DC

Double Pole

Vertical PC

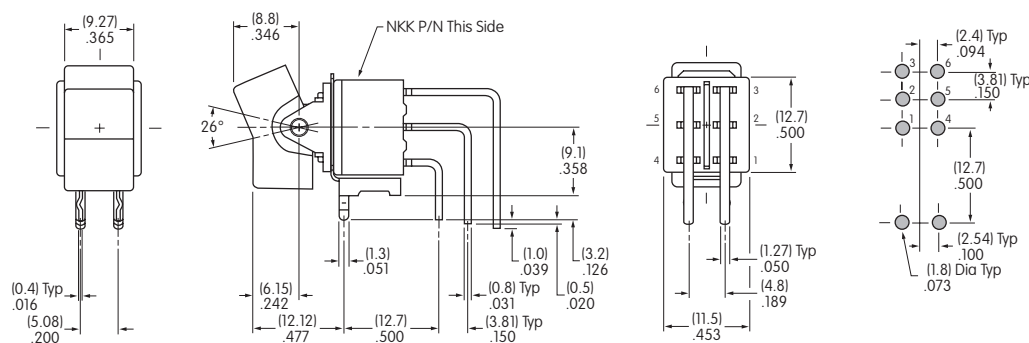

M2T22TXG41-DC

## LEGENDS

NKK Switches can provide custom legends for caps. Contact factory for more information.

### Suggested Printable Area for Cap

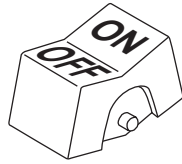

AT4148



AT4150

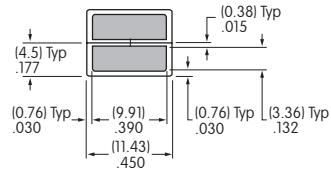
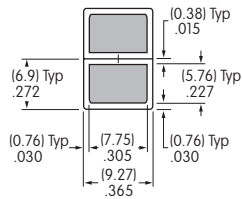

Shaded areas are printable areas.

#### Recommended Print Method:

Pad Print

Epoxy based ink is recommended.

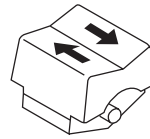



# General Specifications

## Electrical Capacity

**Power Level:** 5A @ 125V AC, 3A @ 250V AC, & 3A @ 30V DC

## Other Ratings

**Contact Resistance:** 10 milliohms maximum

**Insulation Resistance:** 200 megohms minimum @ 500V DC

**Dielectric Strength:** 1,000V AC minimum between contacts for 1 minute minimum;  
1,500V AC minimum between contacts & case for 1 minute minimum

**Mechanical Life:** 30,000 operations minimum

**Electrical Life:** 10,000 operations minimum

**Nominal Operating Force:** 9.94N for rockers & 4.41N for paddles

**Angle of Throw:** 24° for On-None-(On); 28° for all other circuits

## Materials & Finishes

**Housing:** Stainless steel

**Movable Contacts:** Silver alloy

**Stationary Contacts:** Silver

**Base:** Phenolic resin

**Common Terminal:** Copper with silver plating

**End Terminals:** Copper with silver plating

**Lamp Terminals:** Phosphor bronze with nickel plating

## Environmental Data

**Operating Temperature Range:** -10°C through +50°C (+14°F through +122°F)

**Humidity:** 90 ~ 95% humidity for 96 hours @ 40°C (104°F)

**Vibration:** 10 ~ 55Hz with peak-to-peak amplitude of 1.5mm traversing the frequency range & returning in 1 minute; 3 right angled directions for 2 hours

**Shock:** 50G (490m/s<sup>2</sup>) acceleration (tested in 3 right angled directions, with 3 shocks in each direction)

## Installation

**Cap Installation Force:** 9.80N (2.2 lbf) for rockers;

19.61N (4.4 lbf) for paddle

**Soldering Time & Temperature:** Manual Soldering: See Profile A in Supplement section.

## Standards & Certifications

**UL:** File No. E44145 - Recognized only when ordered with marking on switch.  
Add "/U" or "/CUL" before first dash in part number to order UL recognized switch.  
All models recognized at 5A @ 125V AC & 3A @ 250V AC.



# Distinctive Characteristics

Industry's first miniature snap-in, lighted rocker switch.

Actuators in various styles operate with firm, well-defined movements.

Interlocking actuator prevents switch failure due to jamming or window locking.

Two bezel sizes adapt to varied panel cutouts.

Unique stainless steel retaining clips securely hold switches over a range of panel thicknesses, even when exposed to vibration.

Space conserving front panel mounting with minimum behind panel dimension of .902" (22.9mm).

Durable stainless steel housing prevents corrosion.

Isolated lamp circuit for incandescent, LED, and neon lamps. Front panel relamping.

Built-in protective cover shields contacts from dust.

Epoxy sealed solder lug terminals lock out flux, dust, and other contaminants.

Extended lamp terminal for ease of wiring.

Matching indicators available.

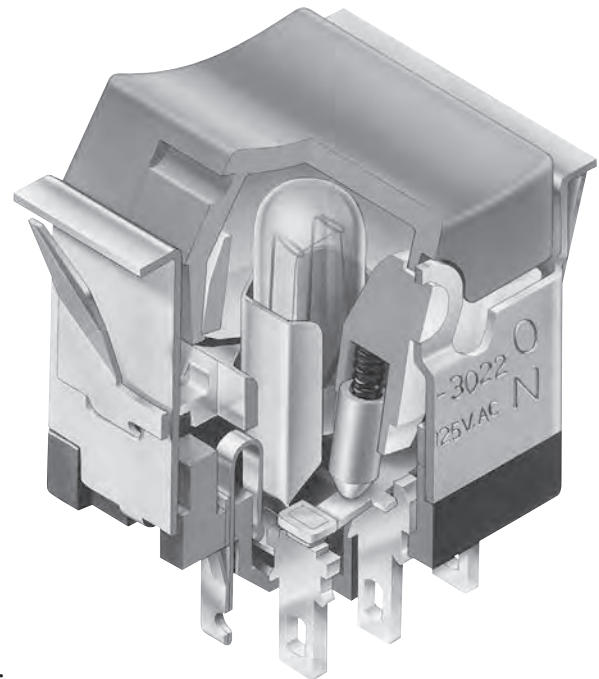

Actual Size

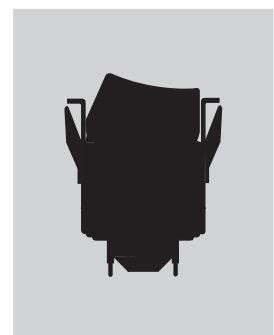

- Toggle
- B** Rockers
- Pushbuttons
- Illuminated PB
- Programmable
- Key locks
- Rotaries
- Slides
- Tactiles
- Tilt
- Touch
- Indicators
- Accessories
- Supplement

### TYPICAL SWITCH ORDERING EXAMPLE

**MLW30**

**2**

**5**

**12**

**DC**

**1A**

#### Poles

1	SPDT
2	SP3T DPDT

#### Circuits

2	ON	NONE	ON
3	ON	OFF	ON
5	ON	NONE	(ON)
8	(ON)	OFF	(ON)
9	ON	OFF	(ON)
0	ON	ON	ON

( ) = Momentary

#### Lamps

##### Incandescent & Neon Lamps

00	No Lamp
06	6-volt
12	12-volt
18	18-volt
24	24-volt
28	28-volt
N	110-volt (not suitable with green & blue)

##### Single Element LED Colors

C	Red
E	Yellow
F	Green

#### Cap Types & Colors

##### Rocker

RA	Black
RB	White
RC	Red
RD	Orange
RE	Yellow
RF	Green
RG	Blue

##### Paddle

PA	Black
PB	White
PC	Red
PD	Orange
PE	Yellow
PF	Green
PG	Blue

##### Design Rocker

DB	White
DC	Red
DD	Orange
DF	Green
DG	Blue

##### LED Rocker

LB	White
LC	Red
LE	Yellow
LF	Green

##### Sculptured Rocker

SB	White
SC	Red
SE	Yellow
SF	Green

#### Bezels/Colors

##### Standard

1A	Black
1B	White
1C	Red
1D	Orange
1E	Yellow
1F	Green
1G	Blue
1H	Gray

##### Large

2A	Black
2B	White
2C	Red
2D	Orange
2E	Yellow
2F	Green
2G	Blue
2H	Gray

#### DESCRIPTION FOR TYPICAL ORDERING EXAMPLE

**MLW3025-12-DC-1A**



#### IMPORTANT:



Switches are supplied without UL & cULus markings unless specified.  
**UL & cULus recognized only when ordered with marking on the switch.**  
 Specific models and ratings noted on the General Specifications page.

## POLES & CIRCUITS

Pole	Model	Rocker Position ( ) = Momentary			Connected Terminals			Throw & Power/Lamp Schematics
		Down	Center	Up	Down	Center	Up	
SP	MLW3012	ON	NONE	ON				Notes: Terminal numbers are not actually on switch. Lamp circuit is isolated and requires an external power source. SPDT 
	MLW3013	ON	OFF	ON				
	MLW3015	ON	NONE	(ON)	2-3	OPEN	2-1	
	MLW3018	(ON)	OFF	(ON)				
	MLW3019	ON	OFF	(ON)				
DP	MLW3022	ON	NONE	ON				DPDT 
	MLW3023	ON	OFF	ON				
	MLW3025	ON	NONE	(ON)	2-3 5-6	OPEN	2-1 5-4	
	MLW3028	(ON)	OFF	(ON)				
	MLW3029	ON	OFF	(ON)				

### For 3 Throw (3-On)

Pole	Model	Down	Center	Up	Connected Terminals & Schematics			External Connection
SP	MLW3020	ON	ON	ON				The SP3T model utilizes a double pole base. External connection must be made during field installation. 
With External Connection					2-6	2-4	2-1	
Without External Connection					2-3 5-6	2-3 5-4	2-1 5-4	

## TERMINALS

### Switch Terminals

Center terminal is .020" (0.5mm) longer

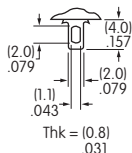

### Lamp Terminals

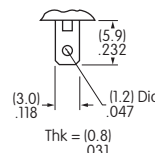

## LAMP CODES & SPECIFICATIONS

Electrical specifications are determined at a basic temperature of 25°C. Lamp circuit is independent of switch operation. For dimension drawings of lamps see Accessories & Hardware section. For neon, if the source voltage is greater than rated voltage, a ballast resistor is required. The ballast resistor calculation and more lamp detail are shown in the Supplement.

### Incandescent & Neon Lamps for Solid & Design Caps

AT602 Incandescent	AT602N Neon		06	12	18	24	28	N	
		Voltage	6V AC	12V AC	18V AC	24V AC	28V AC	110V AC	
		Current	80mA	50mA	35mA	25mA	22mA	1.5mA	
		MSCP	.159	.215	.398	.215	.247	NA	
		Endurance	2,000 Average					15,000 Average	
		Ambient Temperature Range	-10°C ~ +50°C					-10°C ~ +50°C	
		Recommended Resistor for Neon: 33K ohms for 110V AC; 100K ohms for 220V AC							
		<b>00</b> No Lamp	Code 00 indicates that no lamp is used.						



T-1 1/2 Pilot Slide Base

## LED COLOR CODES & SPECIFICATIONS

### Single Element LED

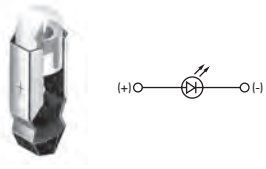
AT622 LED	Resistor value calculation is shown in the Supplement.	Color	<b>C</b>	<b>E</b>	<b>F</b>
			Red	Yellow	Green
 <p>T-1 1/4 Pilot Slide Base</p>	Maximum Forward Current	$I_{FM}$	30mA	30mA	30mA
	Typical Forward Current	$I_F$	20mA	20mA	20mA
	Forward Voltage	$V_F$	1.85V	2.0V	2.1V
	Maximum Reverse Voltage	$V_{RM}$	5V	5V	5V
	Current Reduction Rate Above 25°C	$\Delta I_F$	0.40mA/°C	0.40mA/°C	0.40mA/°C
	Ambient Temperature Range			-10°C ~ +50°C	

## CAP TYPES & COLORS

### For Incandescent or Neon Lamps

#### RA AT405 Rocker

- RB RE
- RC RF
- RD RG

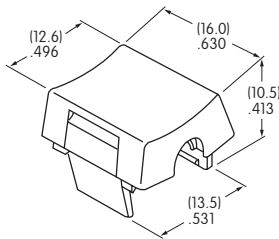

#### PA AT426 Paddle

- PB PE
- PC PF
- PD PG

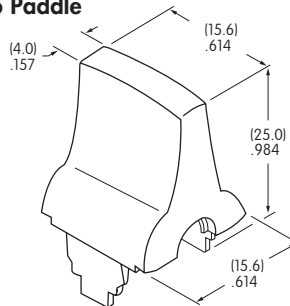

#### DB AT438 Design Rocker

- DC
- DD
- DF
- DG

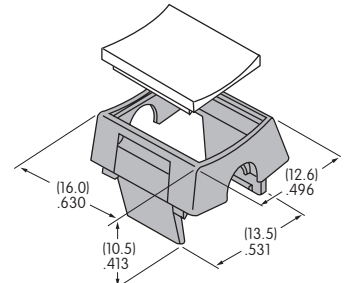

Material: Translucent Polycarbonate Standard Finish: Glossy  
Black Rocker/Paddle not for use with lamp

Translucent Colored Filter  
Opaque Black Rocker Base

### For LED

#### LB AT4125 LED Rocker

- LC
- LE
- LF

Translucent Colored Diffuser and Opaque Black Rocker Base

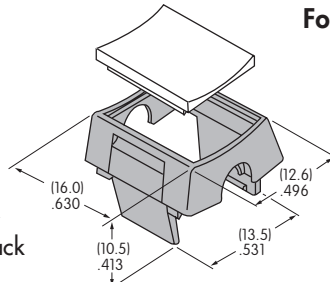

#### SB AT4127 Sculptured Rocker

- SC
- SE
- SF

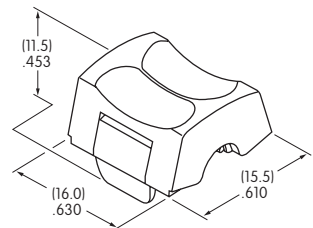

Material: Translucent Polycarbonate Standard Finish: Glossy

### Color Codes:

- A** Black
- B** White
- C** Red
- D** Orange
- E** Yellow
- F** Green
- G** Blue

## OPTIONAL BEZELS

### AT204 Standard Bezel .787" (20.0mm) Wide

- 1A 1E
- 1B 1F
- 1C 1G
- 1D 1H

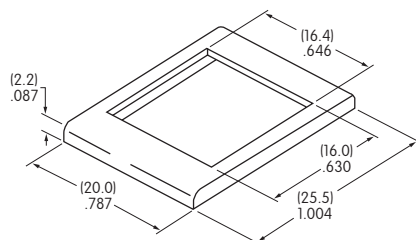

Material: Polycarbonate Standard Finish: Glossy

### AT9201 Large Bezel .937" (23.8mm) Wide

- 2A 2E
- 2B 2F
- 2C 2G
- 2D 2H

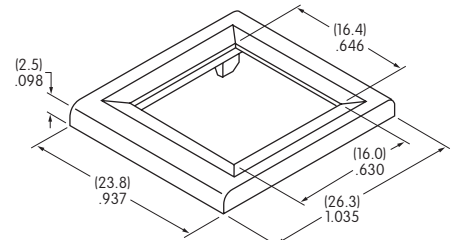

Material: Polycarbonate Standard Finish: Glossy

Toggles  
Rockers  
Pushbuttons  
Illuminated PB  
Programmable  
Keylocks  
Rotaries  
Slides  
Tactiles  
Tilt  
Touch  
Indicators  
Accessories  
Supplement

## TYPICAL SWITCH DIMENSIONS

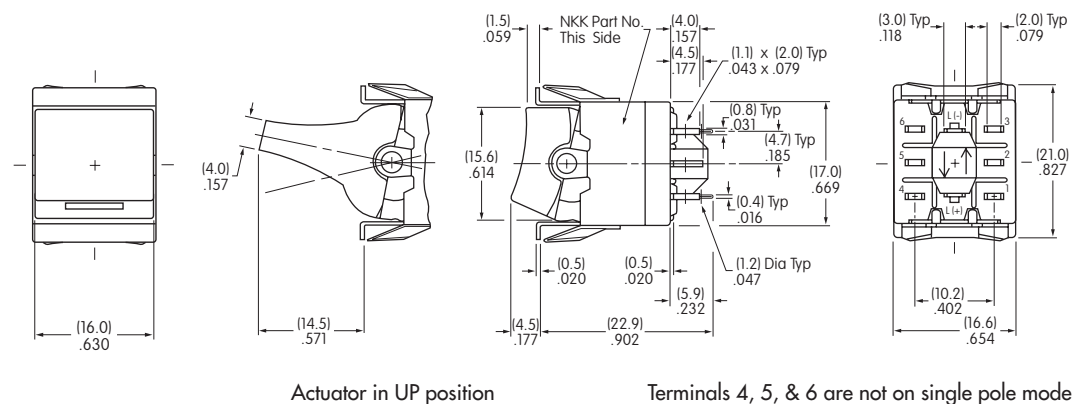

Without Bezel  
Single & Double Pole



**MLW3022-12-PC**

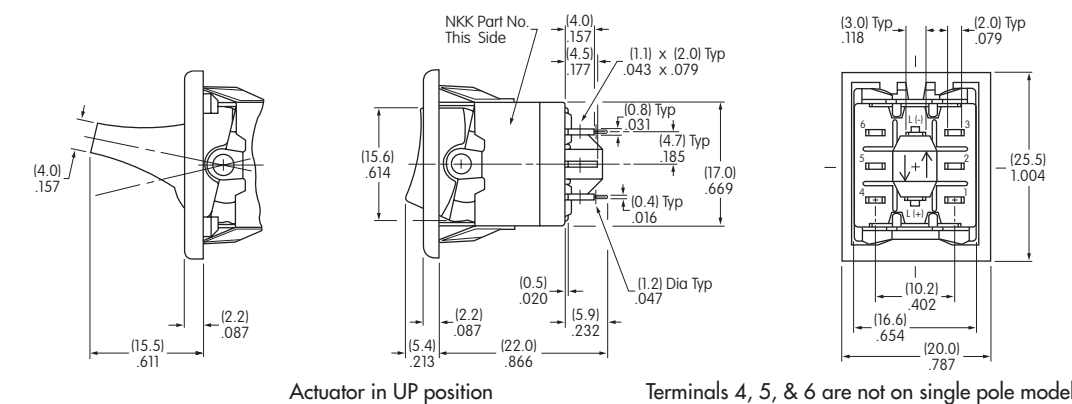

Standard Bezel  
Single & Double Pole



**MLW3022-12-RC-1A**

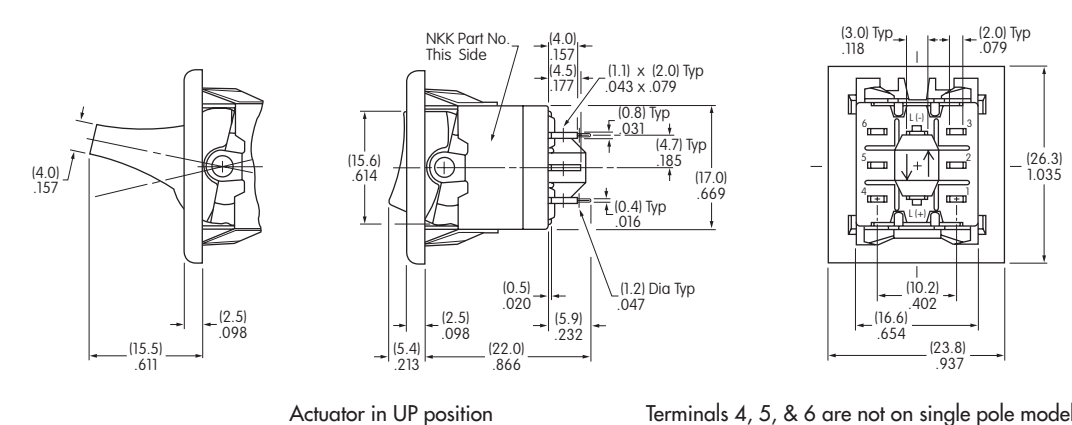

Large Bezel  
Single & Double Pole



**MLW3022-12-PC-2A**

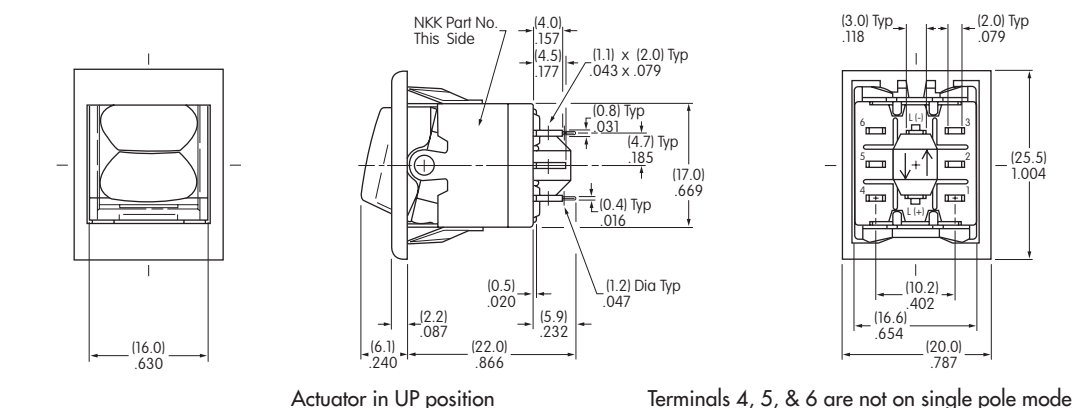

Sculptured Cap  
Single & Double Pole



**MLW3022-C-SC-1A**

### PANEL CUTOUTS & THICKNESSES

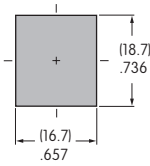

Without Bezel  
.039" ~ .157" (1.0mm ~ 4.0mm)

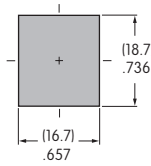

With Standard Bezel AT204  
.039" ~ .118" (1.0mm ~ 3.0mm)



With Large Bezel AT9201  
.039" ~ .118" (1.0mm ~ 3.0mm)

### INSTALLATION & MAINTENANCE

Lamps and LEDs can be changed without removing the switch from the panel. The lamp extractor AT107 assists in removing lamps and LEDs.

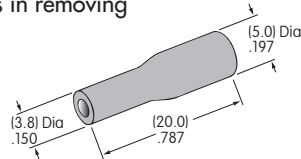

**AT107**  
Lamp Extractor

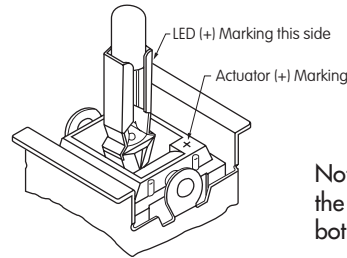

Note: When changing LEDs, match the positive polarity markings on both lamp base and actuator block.

### LEGENDS

NKK Switches can provide custom legends for caps. Contact factory for more information.

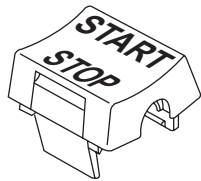

#### Recommended Print Method:

Pad Print

Epoxy based ink is recommended

Rocker

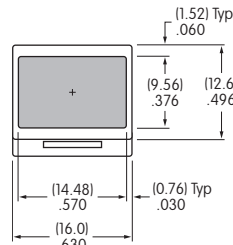

Design Rocker & LED Rocker

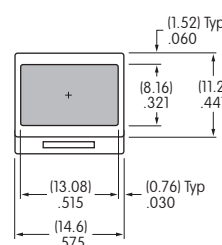

Bezel

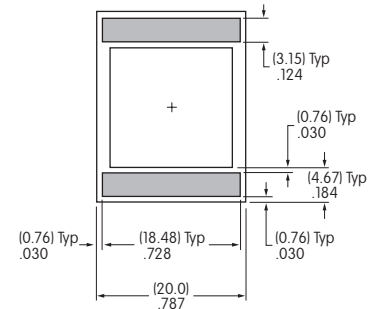

Shaded areas are printable areas.



# General Specifications

## B Electrical Capacity

<b>Resistive Load:</b>	10A @ 125V AC or 6A @ 250V AC
<b>Motor Load:</b>	400W @ 125V AC
<b>Lamp Load:</b>	2A @ 125V AC for On-Off-On circuit & 3A @ 125V AC for other circuits

## Other Ratings

<b>Contact Resistance:</b>	10 milliohms maximum
<b>Insulation Resistance:</b>	1,000 megohms minimum @ 500V DC
<b>Dielectric Strength:</b>	2,000V AC minimum between contacts for 1 minute minimum; 4,000V AC minimum between contacts & case for 1 minute minimum
<b>Mechanical Life:</b>	50,000 operations minimum
<b>Electrical Life:</b>	25,000 operations minimum
<b>Angle of Throw:</b>	25°

## Materials & Finishes

<b>Frame:</b>	Stainless steel
<b>Case/Base:</b>	Diallyl phthalate resin (UL94V-0)
<b>Movable Contacts:</b>	Silver alloy with silver plating
<b>Stationary Contacts:</b>	Pure silver with silver plating
<b>Terminals:</b>	Copper with silver plating

## Environmental Data

<b>Operating Temp Range:</b>	-10°C through +85°C (+14°F through +185°F)
<b>Humidity:</b>	90 ~ 95% humidity for 96 hours @ 40°C (104°F)
<b>Vibration:</b>	10 ~ 55Hz with peak-to-peak amplitude of 1.5mm traversing the frequency range & returning in 1 minute; 3 right angled directions for 2 hours
<b>Shock:</b>	50G (490m/s <sup>2</sup> ) acceleration (tested in 6 right angled directions, with 5 shocks in each direction)

## Installation

<b>Soldering Time &amp; Temp:</b>	Wave Soldering (Straight PC): See Profile A in Supplement section. Manual Soldering: See Profile A in Supplement section.
<b>Cleaning:</b>	These devices are not process sealed. Hand clean locally using alcohol based solution.

## Standards & Certifications

**Flammability Standards:** UL94V-0 rated case/base

- UL:** **File No. E44145 - Recognized only when ordered with marking on switch.**  
Add "/U" before dash in part number to order UL recognized switch.  
Add "/CUL" before dash in part number to order cULus recognized switch.  
All models recognized at 10A @ 125V AC & 6A @ 250V AC.
- CSA:** **File No. 023535\_0\_000 - Certified only when ordered with marking on switch.**  
Add "/C" before dash in part number to order CSA certified switch.  
All models certified at 10A @ 125V AC & 6A @ 250V AC.
- VDE:** License No. 119174  
All models approved at 10A @ 125V AC & 6A @ 250V AC.  
Marking on switch is standard. All models meet EN 61058-1 standard.



# Distinctive Characteristics

Meets EN 61058-1 standard.

Contacts of special silver alloy resist arcing and guarantee stable electrical contact and long life.

Stainless steel frame resists corrosion and increases environmental safety.

High insulating barriers increase isolation of circuits in double pole devices and provide added protection to contact points.

Case/base of heat resistant resin meets UL94V-0 flammability standard.

Prominent external insulating barriers increase insulation resistance and dielectric strength.

Clinching of the frame to the case well above the base and terminals provides 4,000V dielectric strength.

Epoxy sealed terminals prevent entry of flux, solvents, and other contaminants.

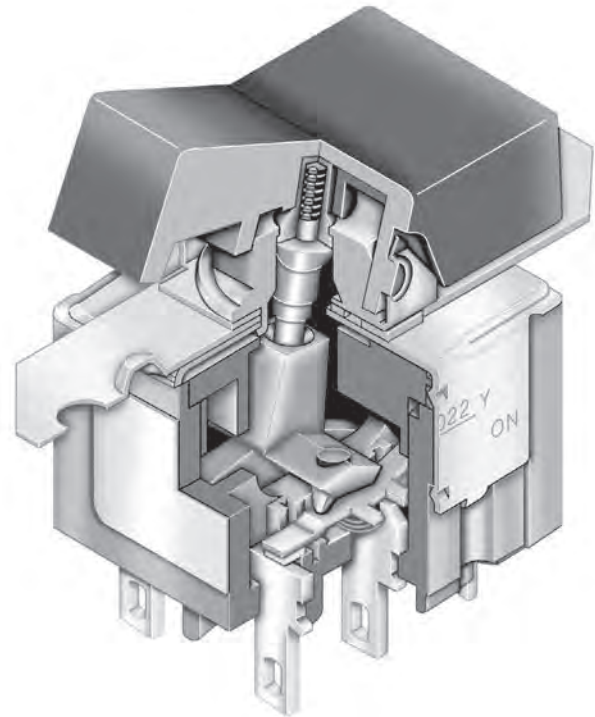

Actual Size

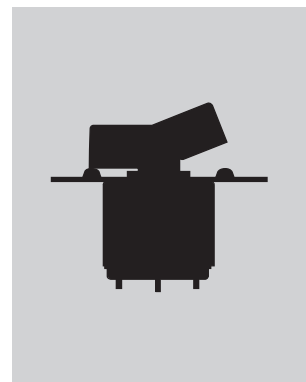

- Toggle
- B** Rockers
- Pushbuttons
- Illuminated PB
- Programmable
- Key locks
- Rotaries
- Slides
- Tactiles
- Tilt
- Touch
- Indicators
- Accessories
- Supplement

### TYPICAL SWITCH ORDERING EXAMPLE

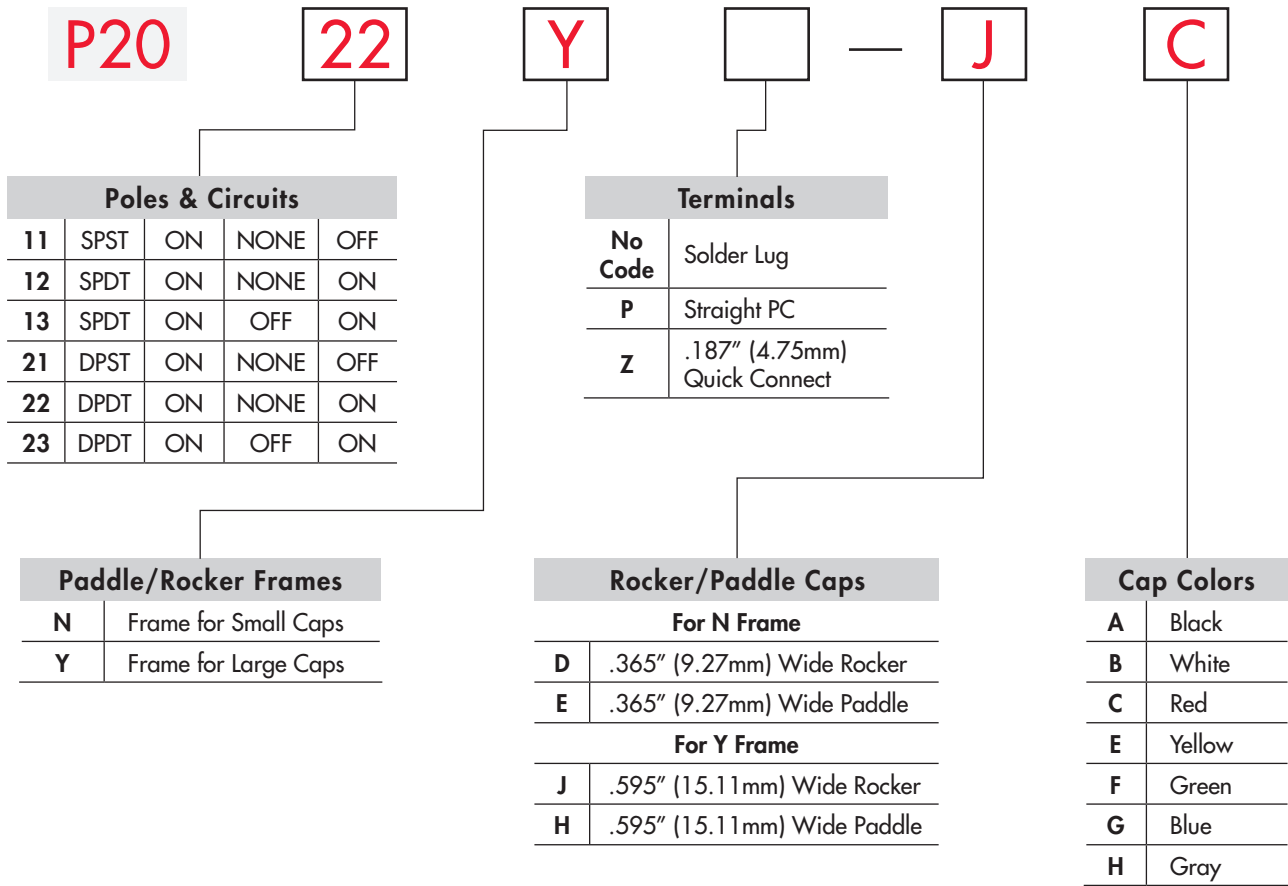

#### IMPORTANT:



VDE is marked on all models. Switches are supplied without UL, cULus & CSA marking unless specified. **UL, cULus & CSA recognized only when ordered with marking on the switch.** Specific models, ratings, & ordering instructions are noted on General Specifications page.

#### DESCRIPTION FOR TYPICAL ORDERING EXAMPLE

#### P2022Y-JC

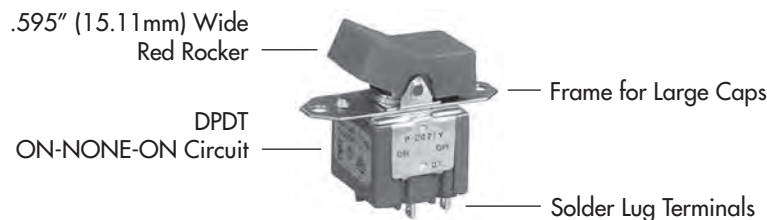

## POLES & CIRCUITS

Pole	Model	Rocker Position			Connected Terminals			Throw & Schematics
		Down	Center	Up	Down	Center	Up	
SP	P2011	ON	NONE	OFF	1-1b	OPEN	OPEN	SPST 
SP	P2012 P2013	ON ON	NONE OFF	ON ON	1-1b	OPEN	1-1a	SPDT 
DP	P2021	ON	NONE	OFF	1-1b 2-2b	OPEN	OPEN	DPST 
DP	P2022 P2023	ON ON	NONE OFF	ON ON	1-1b 2-2b	OPEN	1-1a 2-2a	DPDT 

## ROCKER/PADDLE FRAMES

**N** Frame for Small Actuator

**Y** Frame for Large Actuator

Using AT4148 & AT4149

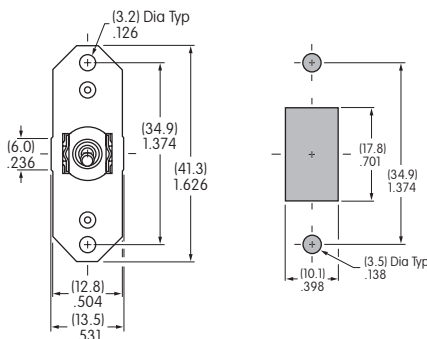

Maximum Panel Thickness: .126" (3.2mm)

Using AT4156 & AT4157

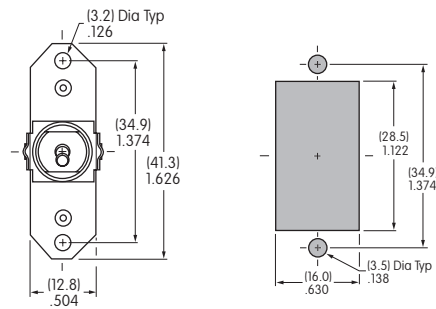

Maximum Panel Thickness: .126" (3.2mm)

## TERMINALS

**No Code** Solder Lug

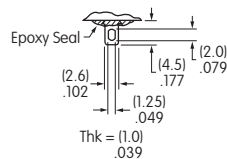

**Z** .187" (4.75mm) Quick Connect

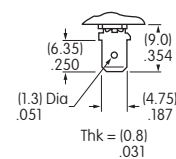

**P** Straight PC

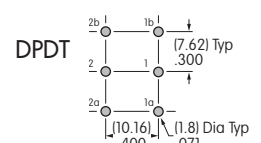
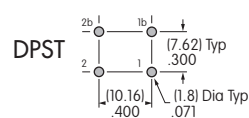
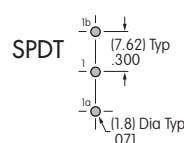
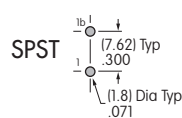
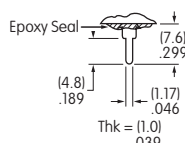

## ROCKER/PADDLE CAPS

For N Frame

**D** AT4148  
.365" (9.27mm) Wide Rocker

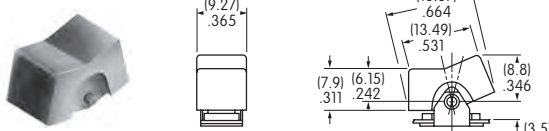

**E** AT4149  
.365" (9.27mm) Wide Paddle

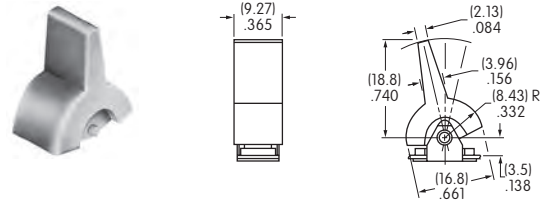

For Y Frame

**J** AT4156  
.595" (15.1mm) Wide Rocker

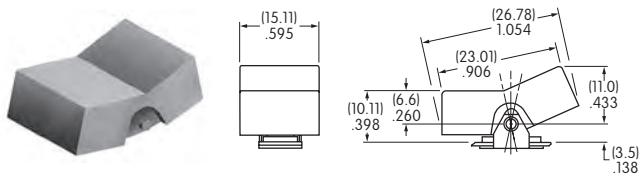

**H** AT4157  
.595" (15.1mm) Wide Paddle

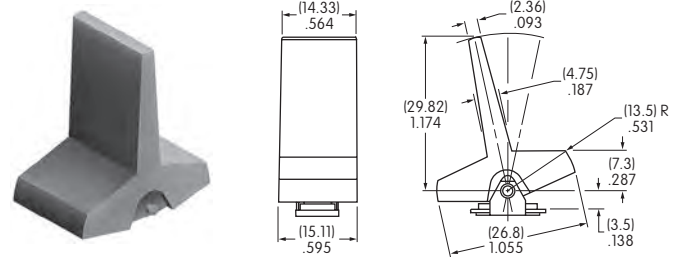

Cap Colors Available:

- A** Black
- B** White
- C** Red
- E** Yellow
- F** Green
- G** Blue
- H** Gray

Material: Polyamide Finish: Matte

## TYPICAL SWITCH DIMENSIONS

N Frame

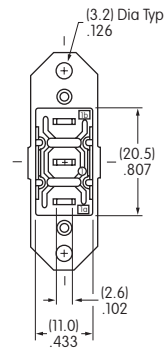
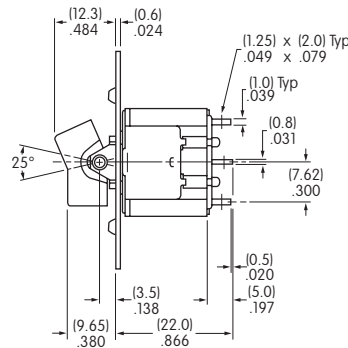
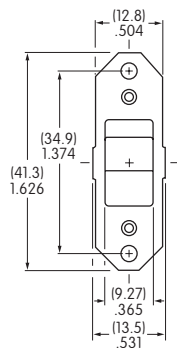

P2012N-DC

P2011 & P2021 models do not have terminals 1a & 2a.

Y Frame

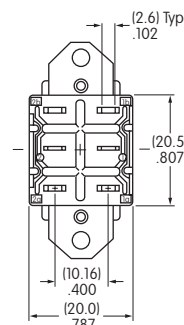
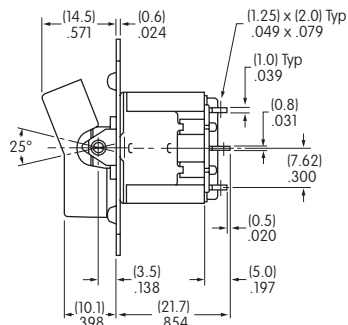
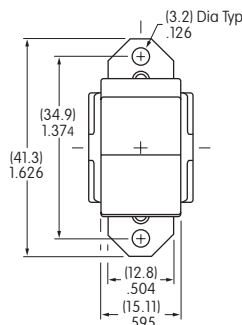

P2022Y-JC

P2011 & P2021 models do not have terminals 1a & 2a.



## GENERAL SPECIFICATIONS FOR SW3000s

Toggles

Rockers

Pushbuttons

Illuminated PB

Programmable

Keylocks

Rotaries

Slides

Tactiles

Tilt

Touch

Indicators

Accessories

Supplement

**B Electrical Capacity (Resistive & Inductive Load)****Power Level:** Shown in the following tables**Other Ratings**

- Contact Resistance:** 10 milliohms maximum  
**Insulation Resistance:** 1,000 megohms minimum @ 500V DC  
**Dielectric Strength:** 2,000V AC minimum for 1 minute minimum  
**Mechanical Life:** 30,000 operations minimum  
**Electrical Life:** 10,000 operations minimum  
**Angle of Throw ( $\alpha$ ):** Shown on drawings or following tables

**Materials & Finishes**

- Rocker:** Urea resin; all rockers are white.  
**Mounting Frame:** Steel with chromate plating over zinc plating  
**Case Cover/Insulator:** Phenolic resin  
**Case:** Melamine phenol  
**Movable Contactor Plate:** Copper with silver plating  
**Movable & Stationary Contacts:** Silver alloy plus copper with silver plating  
**Terminals:** Copper with tin plating

**Environmental Data**

- Operating Temp Range:** -10°C through +70°C (+14°F through +158°F)  
**Sealing:** Dustproof cover of silicone rubber on SW3006A, SW3007A, & SW3008A

**Installation**

- Maximum Panel Thickness:** Shown with following drawings  
**Soldering Time & Temperature:** Manual Soldering: See Profile A in Supplement section.

**Standards & Certifications**

- UL:** File No. E44145 - Recognized only when ordered with marking on switch.  
 Add "/U" or "/CUL" to end of part number to order UL recognized switch.  
 UL or cULus recognition designated beside part numbers on following pages.  
 See Supplement section to find UL or cULus rating details.
- CSA:** File No. 023535\_0\_000 - Certified only when ordered with marking on switch.  
 Add "/C" to end of part number to order CSA certified switch.  
 CSA certification designated beside part numbers on following pages.  
 See Supplement section to find CSA rating details.
- VDE:** License No. 40028826 - Approved only when ordered with marking on switch.  
 Add "/V" to end of part number to order VDE approved switch.  
 SW3006A at 20A @ 125V AC & 10A @ 250V AC

## SINGLE POLE WITH SOLDER LUG

* UL & CSA recognized only when ordered with marking on switch (see General Specs)		Rocker Position/Connected Terminals						Electrical Capacity				$\alpha =$ Angle of Throw
Model	* Approvals		Pole	Down	Center	Up	Resistive			Inductive		
	UL	CSA					AC 125V	AC 250V	DC 30V	AC 125V PF 0.6		
SW3001A	✓	✓	SPST	ON 1-3	NONE	OFF —	15A	6A	15A	10A	24°	
SW3002A	✓	✓	SPDT	ON 2-3	NONE	ON 2-1	15A	6A	15A	10A	24°	
SW3003A	✓	✓	SPDT	ON 2-3	OFF	ON 2-1	15A	6A	15A	10A	28°	

**Throw & Schematics:**

SPST: INTERNAL CONNECTION

SPDT: 2 (COM)

Note: Terminal numbers are actually on the switch.

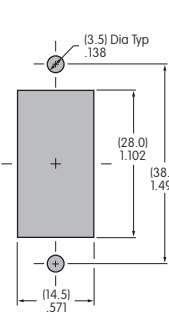
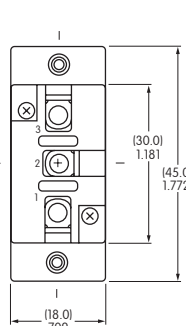
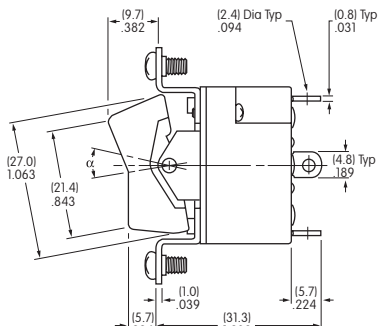
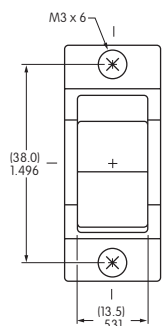

Maximum Effective Panel Thickness:

SW3001A does not have terminal 2. .197" (5.0mm) for SW3001A & SW3002A models; .177" (4.5mm) for SW3003A models

**SW3001A**

## DOUBLE POLE WITH SOLDER LUG

* UL, cULus & CSA recognized only when ordered with marking on switch (see General Specs)		Rocker Position/Connected Terminals ( ) = Momentary						Electrical Capacity				$\alpha =$ Angle of Throw
Model	* Approvals		Pole	Down	Center	Up	Resistive			Inductive		
	UL	CSA					AC 125V	AC 250V	DC 30V	AC 125V PF 0.6		
SW3006A	✓	✓	DPDT	ON 2-3 5-6	NONE	ON 2-1 5-4	20A	10A	20A	10A	24°	
SW3007A	—	—	DPDT	ON 2-3 5-6	OFF	ON 2-1 5-4	15A	6A	15A	10A	28°	
SW3008A	—	—	DPDT	(ON) 2-3 5-6	OFF	(ON) 2-1 5-4	15A	6A	15A	10A	24°	

**Throw & Schematic:**

DPDT: 2 (COM) 5

Note: Terminal numbers are actually on the switch.

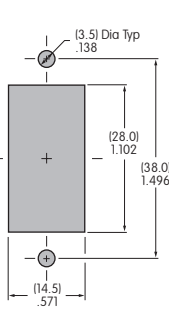
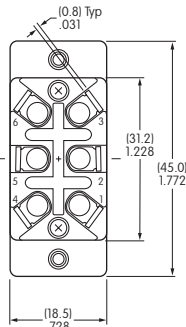
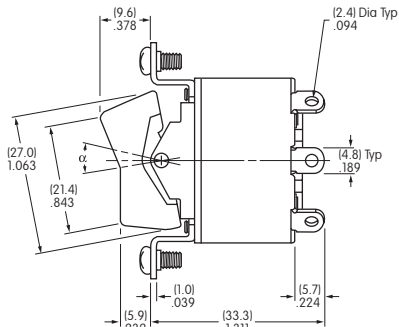
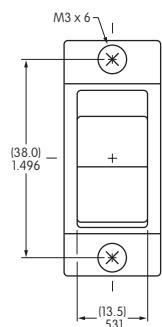

Maximum Effective Panel Thickness:

.197" (5.0mm) for SW3006A & SW3008A models; .177" (4.5mm) for SW3007A models

**SW3006A**

Toggle  
Rockers  
Pushbuttons  
Illuminated PB  
Programmable  
Keylocks  
Rotaries  
Slides  
Tactiles  
Tilt  
Touch  
Indicators  
Accessories  
Supplement

## GENERAL SPECIFICATIONS FOR SW3800s

Toggle

Rockers

Pushbuttons

Illuminated PB

Programmable

Keylocks

Rotaries

Slides

Tactiles

Tilt

Touch

Indicators

Accessories

Supplement

### B Electrical Capacity (Resistive & Inductive Load)

**Power Level:** Shown in the following tables  
 Note: See Supplement section for details of design for inductive DC loads.

### Other Ratings

**Contact Resistance:** 10 milliohms maximum  
**Insulation Resistance:** 1,000 megohms minimum @ 500V DC  
**Dielectric Strength:** 2,000V AC minimum for 1 minute minimum  
**Mechanical Life:** 50,000 operations minimum  
**Electrical Life:** 25,000 operations minimum  
**Angle of Throw:** Shown on following drawings  
**Nominal Operating Force:** 1,800 grams for SW3822  
 2,200 grams for SW3823 Off to On  
 800 grams for SW3823 On to Off

### Materials & Finishes

**Rocker:** Urea resin; all rockers are white.  
**Mounting Frame:** Steel with chromate plating over zinc plating  
**Case Cover/Insulator:** Phenolic resin  
**Case:** Melamine phenol  
**Movable Contacts:** Copper with silver plating  
**Stationary Contacts:** Silver alloy plus copper with silver plating  
**Terminals:** Brass (terminal screws of brass with nickel plating)

### Environmental Data

**Operating Temp Range:** -10°C through +70°C (+14°F through +158°F)

### Standards & Certifications

**UL:** File No. E44145 - Recognized only when ordered with marking on switch.  
 Add "/U" or "/CUL" to end of part number to order UL recognized switch.  
 UL or cULus recognition designated beside part numbers on following pages.  
 See Supplement section to find UL or cULus rating details.

**CSA:** File No. 023535\_0\_000 - Certified only when ordered with marking on switch.  
 Add "/C" to end of part number to order CSA certified switch.  
 CSA certification designated beside part numbers on following pages.  
 See Supplement section to find CSA rating details.

### Wiring for SW3821D with Electrical Capacity of DC400V 10A

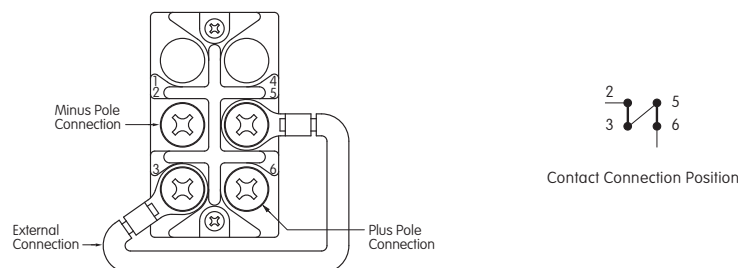



## DOUBLE POLE WITH SCREW LUG

Model	* Approvals UL cULus CSA	Pole	Rocker Position/Connected Terminals						Electrical Capacity							
			Down		Center	Up		Resistive				Inductive				
			ON	2-3 5-6	NONE	OFF	—	AC 125V	AC 250V	DC 30V	DC 48V	DC 125V	DC 250V	DC 400V	AC 125V PF 0.6	AC 250V PF 0.6
SW3821	✓	DPST	ON	2-3 5-6	NONE	OFF	—	30A	30A	30A	—	1A	—	—	30A	15A
SW3822	✓	DPDT	ON	2-3 5-6	NONE	ON	2-1 5-4	30A	30A	30A	—	1A	—	—	30A	15A
SW3823	✓	DPDT	ON	2-3 5-6	OFF	ON	2-1 5-4	30A	30A	30A	—	1A	—	—	30A	15A
SW3821D	✓	DPST	ON	2-3 5-6	NONE	OFF	—	—	—	30A	30A	20A	15A	4A (10A)	—	—
SW3822D	✓	DPDT	ON	2-3 5-6	NONE	ON	2-1 5-4	—	—	30A	30A	20A	15A	4A	—	—
SW3823D	✓	DPDT	ON	2-3 5-6	OFF	ON	2-1 5-4	—	—	30A	30A	15A	—	—	—	—

**Throw & Schematics:**

DPST:

DPDT:

Note: Terminal numbers are actually on the switch.

\* UL/CUL & CSA for the following ratings: UL/CUL: 30A @ 30V DC, 15A @ 125V DC; CSA: 30A @ 30V DC, 15A @ 125V DC

\* UL, cULus & CSA recognized only when ordered with marking on switch (see General Specs)

( ) capacity is due to series wiring, see General Specifications page.

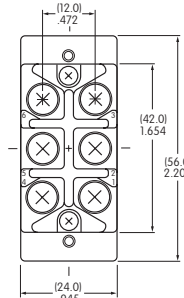
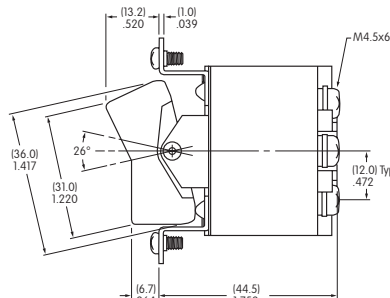
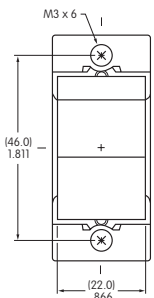

SW3821 & SW3821D do not have terminals 1 & 4.

Maximum Effective Panel Thickness .177" (4.5mm). Panel cutout shown below.

**SW3822**

## THREE POLE WITH SCREW LUG

Model	* Approvals UL cULus CSA	Pole	Rocker Position/Connected Terminals						Electrical Capacity					
			Down		Center	Up		Resistive			Inductive			
			ON	2-3 5-6 8-9	NONE	OFF	—	AC 125V	AC 250V	DC 30V	DC 125V	AC 125V PF 0.6	AC 250V PF 0.6	
SW3831	✓	3PST	ON	2-3 5-6 8-9	NONE	OFF	—	30A	30A	30A	1A	30A	15A	
SW3832	✓	3PDT	ON	2-3 5-6 8-9	NONE	ON	2-1 5-4 8-7	30A	30A	30A	1A	30A	15A	
SW3833	✓	3PDT	ON	2-3 5-6 8-9	OFF	ON	2-1 5-4 8-7	30A	30A	30A	1A	30A	15A	
SW3831D	✓	3PST	ON	2-3 5-6 8-9	NONE	OFF	—	—	—	30A	15A	—	—	
SW3832D	✓	3PDT	ON	2-3 5-6 8-9	NONE	ON	2-1 5-4 8-7	—	—	30A	15A	—	—	
SW3833D	✓	3PDT	ON	2-3 5-6 8-9	OFF	ON	2-1 5-4 8-7	—	—	30A	15A	—	—	

**Throw & Schematics:**

3PST:

3PDT:

Note: Terminal numbers are actually on the switch.

\* UL/CUL & CSA for the following ratings: UL/CUL: 30A @ 30V DC, 15A @ 125V DC; CSA: 30A @ 30V DC, 15A @ 125V DC

\* UL, cULus & CSA recognized only when ordered with marking on switch (see General Specs)

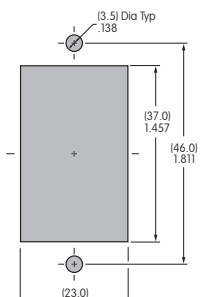
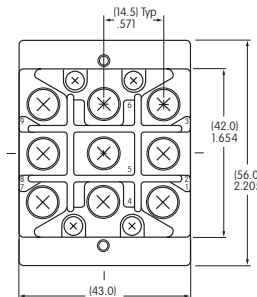
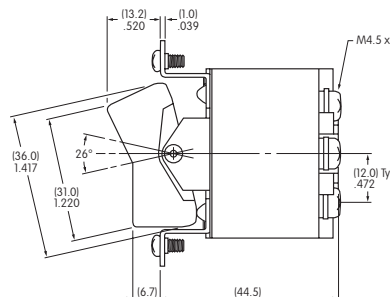
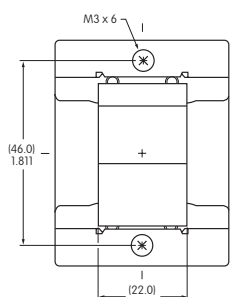

SW3831 & SW3831D do not have terminals 1, 4 & 7.

Maximum Effective Panel Thickness .177" (4.5mm)

# General Specifications

Toggles

Rockers

Pushbuttons

Illuminated PB

Programmable

Keylocks

Rotaries

Slides

Tactiles

Tilt

Touch

Indicators

Accessories

Supplement

## B Electrical Capacity (Resistive Load)

**Power Level:** 15A @ 125/250V AC or 15A @ 30V DC

## Other Ratings

**Contact Resistance:** 10 milliohms maximum for solder lug, screw & quick connect terminal models  
30 milliohms maximum for wire lead terminal models

**Insulation Resistance:** 200 megohms minimum @ 500V DC

**Dielectric Strength:** 1,250V AC minimum between contacts for 1 minute minimum  
3,750V AC minimum between contacts & case for 1 minute minimum

**Mechanical Life:** 30,000 operations minimum

**Electrical Life:** 15,000 operations minimum for circuit 11 and 12 models  
10,000 operations minimum for circuit 13, 15, 18, 19 models

**Angle of Throw:** 24°

## Materials & Finishes

**Rocker:** Phenylene oxide

**Outer Housing:** Polyamide (UL94V-0)

**Inner Case:** Melamine (UL94V-0)

**Cover for Wire Lead Models:** Glass fiber reinforced polyamide (UL94V-0)

**Flange Gasket:** Nitrile butadiene rubber

**Movable Contactor:** Copper with silver plating

**Movable Contacts:** Silver alloy plus copper with silver plating

**Stationary Contacts:** Silver alloy plus copper with silver plating

**Terminals:** Brass with tin plating

**Wire Lead Covers:** Heat resistant polyvinyl chloride (Leads are AWG 14)

## Environmental Data

**Operating Temp Range:** -25°C through +85°C (-13°F through +185°F)

**Humidity:** 90 ~ 95% humidity for 96 hours @ 40°C (104°F)

**Vibration:** 10 ~ 55Hz with peak-to-peak amplitude of 1.5mm traversing the frequency range & returning in 1 minute; 3 right angled directions for 2 hours

**Shock:** 50G (490m/s<sup>2</sup>) acceleration (tested in 6 right angled directions, with 5 shocks in each direction)

**Front Panel Seal:** IP67 of IEC60529, dust tight & water protected during temporary immersion for all models

**Behind Panel Seal:** IP60 of IEC60529, dust tight but not water protected for solder lug, screw & quick connect models  
IP67 of IEC60529, dust tight & water protected during temporary immersion for wire lead models

## Installation

**Soldering Time & Temp:** Manual Soldering: See Profile A in Supplement section.

**Cleaning:** Hand clean locally using alcohol based solution.

## Standards & Certifications

**Flammability Standards:** UL94V-0 outer housing, inner case, & outer cover on wire lead models

**UL:** **File No. E44145 - Recognized only when ordered with marking on switch.**  
Add "/U" or "/CUL" to end of part number to order UL recognized switch.  
All models approved at 15A @ 125/250V AC & 15A @ 30V DC.

**VDE:** **License No. 40028806 - Approved only when ordered with marking on switch.**  
Add "/V" to end of part number to order VDE approved switch.  
All models approved at 15A @ 250V AC (pending for quick connect).

**EN:** **No. 61058-1**  
WR11 & WR12 models meet European Norm for 3mm contact gap to prevent contact welds.

**Wiring Material Standards:** UL AWM 1015 Recognized at Flammability VW-1.  
Temperature Range -20°C ~ +105°C; Maximum Load 600V; AWG 14.  
CSA TEW 105 Certified at Temperature Range -20°C ~ +105°C; Maximum Load 600V.

# Distinctive Characteristics

Single unit construction of the flange and outer housing gives added protection from environmental elements.

Specially designed contact mechanism for breaking light welds.

Minimal contact bounce achieved with specially designed interlocked switching mechanism.

Heat resistant resin used for outer housing, inner case, and cover on wire lead models meets UL94V-0 flammability standard and provides high arc and tracking resistance.

Available with solder lug, screw, quick connect, and wire lead terminations.

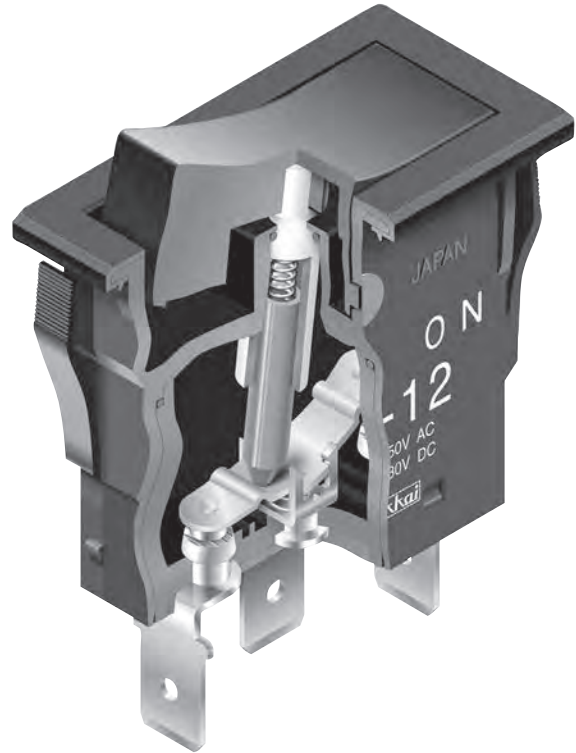

## Sealed Construction Meets IP60 & IP67 Standards

Solder lug, screw, and quick connect terminal models meet IP67 of IEC60529 Standards at front panel (dust tight and water protected for temporary immersion, patent pending). Behind panel standard is IP60 (dust tight but not water protected).

Wire lead models conform fully to IP67 of IEC60529 Standards at front and behind panel (dust tight and water protected for temporary immersion). Switch base is epoxy sealed and covered by an outer case for further protection from dust and water. (Switches cannot be operated under water. Contact factory for further details regarding operating environment.)

Actual Size



### TYPICAL SWITCH ORDERING EXAMPLE

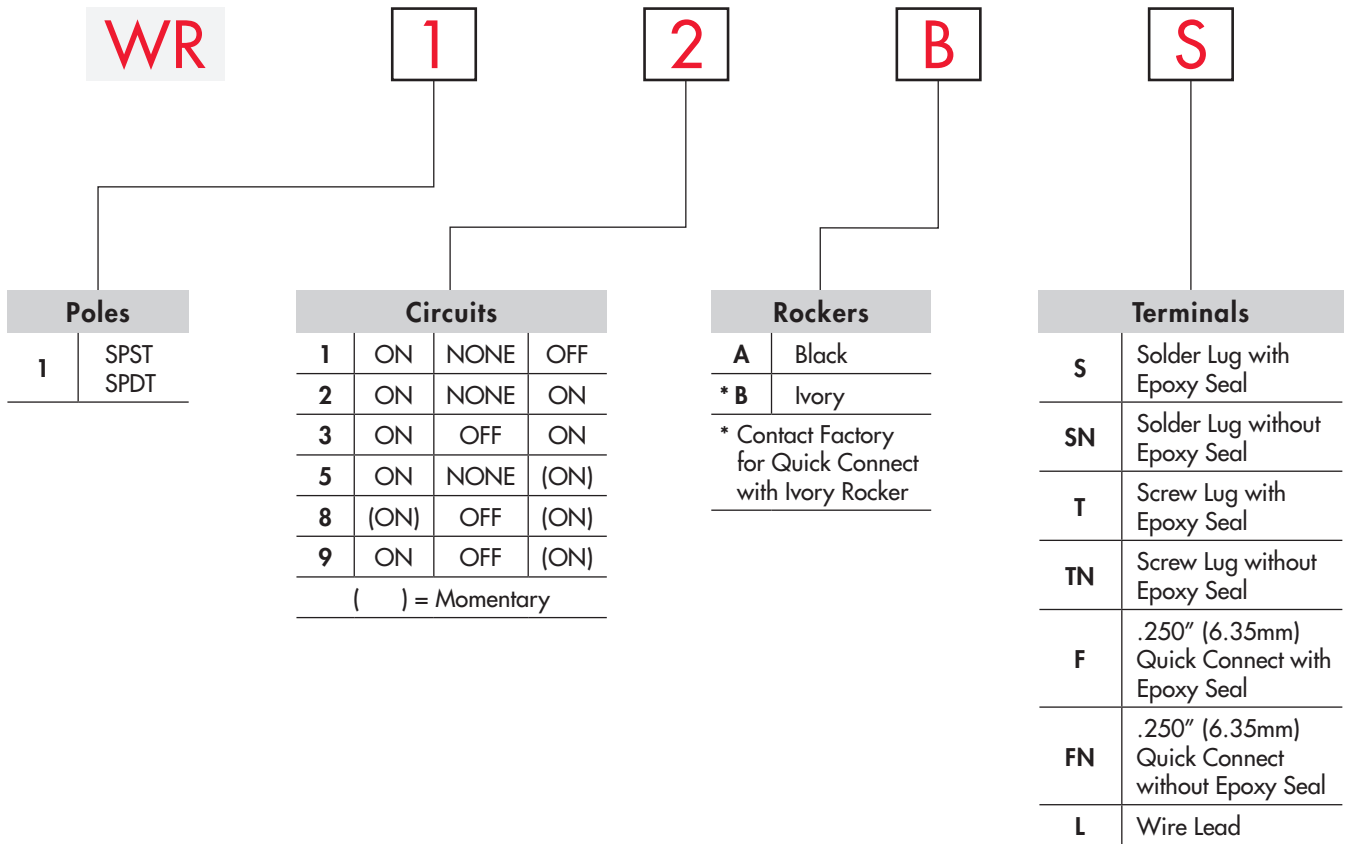

### IMPORTANT:



Switches are supplied without UL, cULus & VDE marking unless specified.  
**UL, cULus & VDE recognized only when ordered with marking on the switch.**  
 Specific models, ratings and ordering instructions are noted on the General Specifications page.

### DESCRIPTION FOR TYPICAL ORDERING EXAMPLE

#### WR12BS

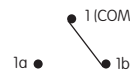

## POLES & CIRCUITS

Pole	Model	Rocker Position ( ) = Momentary			Connected Terminals			Throw & Schematics
		Down	Center	Up	Down	Center	Up	
SP	WR11	ON	NONE	OFF	1a-1b	OPEN	OPEN	SPST 
SP	WR12 WR13 WR15 WR18 WR19	ON ON ON (ON) ON	NONE OFF NONE OFF OFF	ON ON (ON) (ON) (ON)	1-1b	OPEN	1-1a	SPDT 

Toggle  
 Rockers  
 Pushbuttons  
 Illuminated PB  
 Programmable  
 Key locks  
 Rotaries  
 Slides  
 Tactiles  
 Tilt  
 Touch  
 Indicators  
 Accessories  
 Supplement

## TYPICAL SWITCH DIMENSIONS

### Solder Lug Terminals

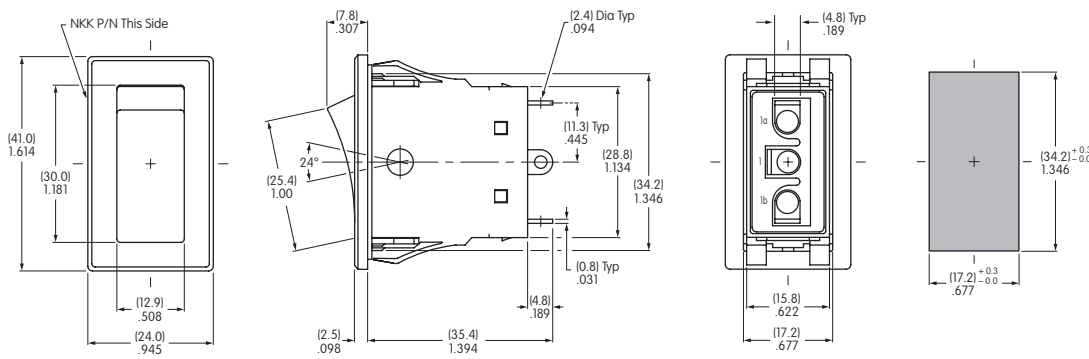

WR11 model does not have terminal 1.

Panel Thickness  
 .039" ~ .157"  
 (1.0mm ~ 4.0mm)

**WR12AS**

### Screw Lug Terminals

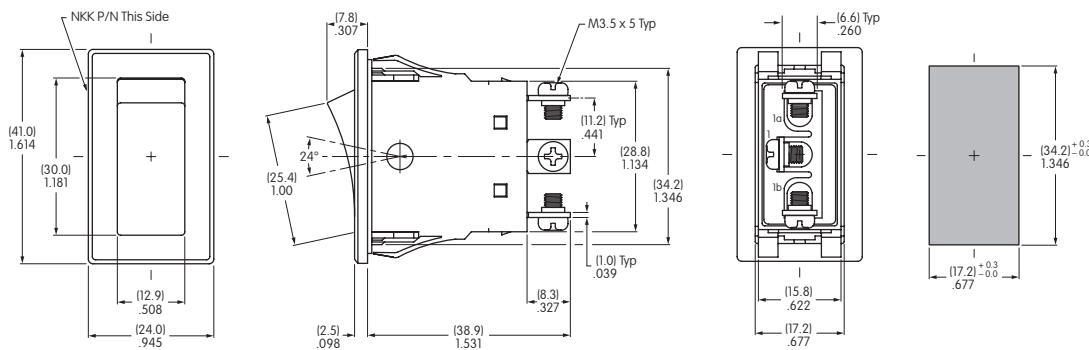

WR11 model does not have terminal 1.

Panel Thickness  
 .039" ~ .157"  
 (1.0mm ~ 4.0mm)

**WR12AT**

## TYPICAL SWITCH DIMENSIONS

### .250" (6.35mm) Quick Connect Terminals

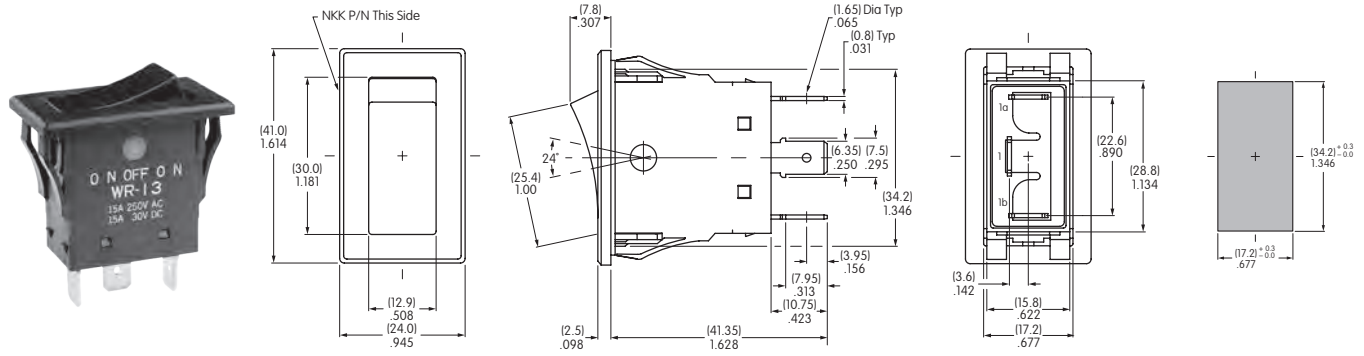

**WR13AF**

WR11 model does not have terminal 1.

Panel Thickness  
.039" ~ .157"  
(1.0mm ~ 4.0mm)

### Wire Lead Terminals

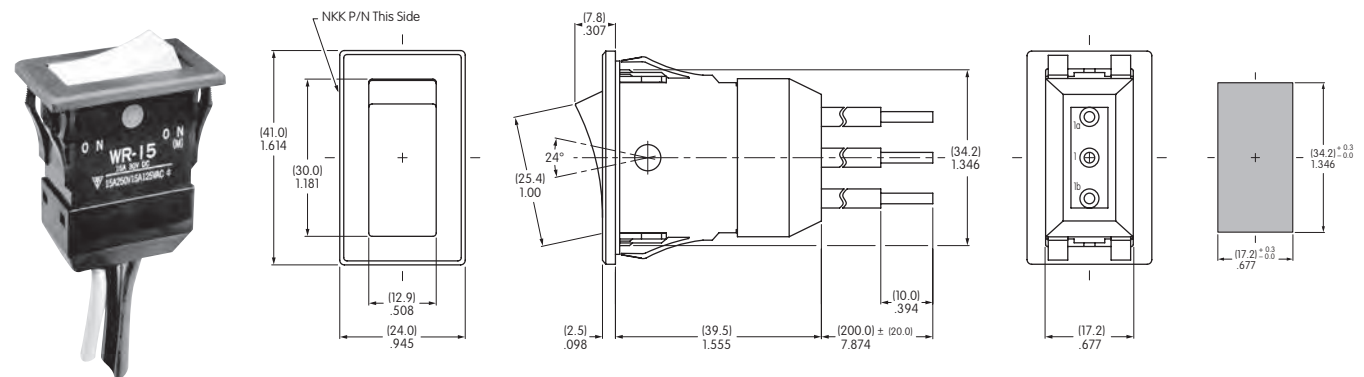

**WR15BL**

WR11 model does not have terminal 1.

Panel Thickness  
.039" ~ .157"  
(1.0mm ~ 4.0mm)

## STANDARD WIRE COLOR SCHEME

Wire leads are covered with heat resistant vinyl in accordance with UL 1015 and CSA TEW 105 Standards for Appliance Wiring Material (AWM).

Terminal Numbers & Wire Colors			
	1a	1	1b
WR11	Black		White
WR12-19	White	Black	Red



# Notes

---





Toggles

Rockers

Pushbuttons

Illuminated PB

Programmable

Keylocks

Rotaries

Slides

Tactiles

Tilt

Touch

Indicators

Accessories

Supplement



## AB Series ..... C6

0.4VA Logic Level; Process Sealed  
Straight, Right Angle, & Vertical PC



## BB Series ..... C12

Antistatic; 0.4VA Logic Level; Process Sealed  
Straight, Right Angle, & Vertical PC



## DB Series ..... C18

0.4VA Logic Level  
Threaded Bushing with Straight PC  
Smooth Bushing with Straight, Right Angle, & Vertical PC



## EB Series ..... C24

3A Power Level & 0.4VA Logic Level  
Solder Lug & Straight PC  
Bushing Mount



## EB Series ..... C30

3A Power Level  
Solder Lug & Straight PC  
Snap-in Mount



## FB Series ..... C38

500mA Power Level & 0.4VA Logic Level  
PC Turret  
Bushing Mount



**GB Series** ..... C44

0.4VA Logic Level; Process Sealed  
Straight, Right Angle, & Vertical PC



**GB2 Series** ..... C48

0.4VA Logic Level  
Straight & Right Angle PC



**G3B Series** ..... C52

0.4VA Logic Level; Process Sealed  
Gull Wing Terminals  
Upright & Right Angle Mount



**JP Series** ..... C58

10A or 16A Power Level  
Solder Lug  
Snap-in Mount



**M2B Series** ..... C64

1A Power Level & 0.4VA Logic Level  
Process Sealed  
Straight, Right Angle, & Vertical PC



**MB2000 Series** ..... C72

6A Power Level & 0.4VA Logic Level  
Solder Lug, Quick Connect, Straight PC, & Wirewrap  
Bushing Mount

Toggle

Rockers

**C** Pushbuttons

Illuminated PB

Programmable

Key locks

Rotaries

Slides

Tactiles

Tilt

Touch

Indicators

Accessories

Supplement

Toggles

Rockers

Pushbuttons

Illuminated PB

Keylocks

Rotaries

Slides

Tactiles

Tilt

Touch

Indicators

Accessories

Supplement



## MB2000 Series ..... C80

6A Power Level & 0.4VA Logic Level  
Straight, Right Angle, & Vertical PC  
PCB Mount



## MB2000 Series ..... C87

6A Power Level & 0.4VA Logic Level  
Solder Lug, Quick Connect, Straight PC, & Wirewrap  
Large Bushing (12mm)



## MB2400 Series ..... C96

3A Power Level & 0.4VA Logic Level  
Solder Lug, Straight PC, & Wirewrap  
Bushing Mount



## MB2400 Series ..... C102

3A Power Level & 0.4VA Logic Level  
Straight, Right Angle, & Vertical PC  
PCB Mount



## MB2400 Series ..... C108

3A Power Level & 0.4VA Logic Level  
Solder Lug, Straight PC, & Wirewrap  
Snap-in Mount



## MB2500 Series ..... C116

3A Power Level & 0.4VA Logic Level  
Solder Lug & Straight PC  
Bushing Mount



**MB2500 Series .....C121**

3A Power Level & 0.4VA Logic Level  
Solder Lug & Straight PC  
PCB Mount



**MB2500 Series .....C124**

3A Power Level & 0.4VA Logic Level  
Solder Lug  
Snap-in Mount



**SB Series .....C128**

3A to 15A Power Level  
Solder Lug & Screw Lug  
Bushing Mount



**SB4011 Series ..... C38**

3A Power Level  
Solder Lug  
Bushing Mount



**SCB Series .....C131**

15A & 1/2 HP Power Level  
Quick Connect  
Bushing Mount



**WB Series .....C134**

Environmentally Sealed  
6A Power Level  
Solder Lug, Screw Lug, & Wire Lead  
Bushing Mount

Toggle

Rockers

**C** Pushbuttons

Illuminated PB

Programmable

Key locks

Rotaries

Slides

Tactiles

Tilt

Touch

Indicators

Accessories

Supplement

# General Specifications

## Electrical Capacity (Resistive Load)

**Logic Level:** 0.4VA maximum @ 28V AC/DC maximum  
(Applicable Range 0.1mA ~ 0.1A @ 20mV ~ 28V)  
Note: Find additional explanation of operating range in Supplement section.

## Other Ratings

**Contact Resistance:** 50 milliohms maximum  
**Insulation Resistance:** 500 megohms minimum @ 500V DC  
**Dielectric Strength:** 500V AC minimum for 1 minute minimum  
**Mechanical Life:** 50,000 operations minimum  
**Electrical Life:** 50,000 operations minimum  
**Nominal Operating Force:** 2.55N  
**Contact Timing:** Nonshorting (break-before-make)  
**Travel:** Pretravel .028" (0.7mm); Overtravel .016" (0.4mm); Total Travel .043" (1.1mm)

## Materials & Finishes

**Plunger:** Polyacetal  
**Case Housing:** Glass fiber reinforced polyamide  
**Support Bracket:** Tin plated phosphor bronze  
**Movable Contact:** Phosphor bronze with gold plating  
**Stationary Contacts:** Brass with gold plating  
**Terminals:** Brass with gold plating

## Environmental Data

**Operating Temp Range:** -30°C through +85°C (-22°F through +185°F)  
**Humidity:** 90 ~ 95% humidity for 96 hours @ 40°C (104°F)  
**Vibration:** 10 ~ 55Hz with peak-to-peak amplitude of 1.5mm traversing the frequency range & returning in 1 minute; 3 right angled directions for 2 hours  
**Shock:** 50G (490m/s<sup>2</sup>) acceleration (tested in 6 right angled directions, with 5 shocks in each direction)

## Installation

**Cap Installation Force:** 49.03N (11.2 lbf) maximum downward force on actuator

## PCB Processing

**Soldering:** Wave Soldering Recommended: See Profile A in Supplement section.  
Manual Soldering: See Profile B in Supplement section.  
**Cleaning:** Automated cleaning. See Cleaning specifications in Supplement section.

## Standards & Certifications

The AB Series pushbuttons have not been tested for UL recognition or CSA certification. These switches are designed for use in a low-voltage, low-current, logic-level circuit. When used as intended in a logic-level circuit, the results do not produce hazardous energy.

# Distinctive Characteristics

Subminiature size (1/3 size of Series M switches) saves space on PC boards.

Specifically developed for logic-level applications.

Totally sealed body construction prevents contact contamination and allows time- and money-saving automated soldering and cleaning.

Award-winning STC contact mechanism with benefits unavailable in conventional mechanisms: smoother, positive detent actuation, increased contact stability and unparalleled logic-level reliability. (Additional STC details in Terms & Acronyms; see Supplement section.)

Molded-in, epoxy sealed or ultrasonically welded terminals lock out flux, solvents, and other contaminants.

.100" x .100" (2.54mm x 2.54mm) terminal spacing conforms to standard PC board grid spacing.

Matching indicators available.

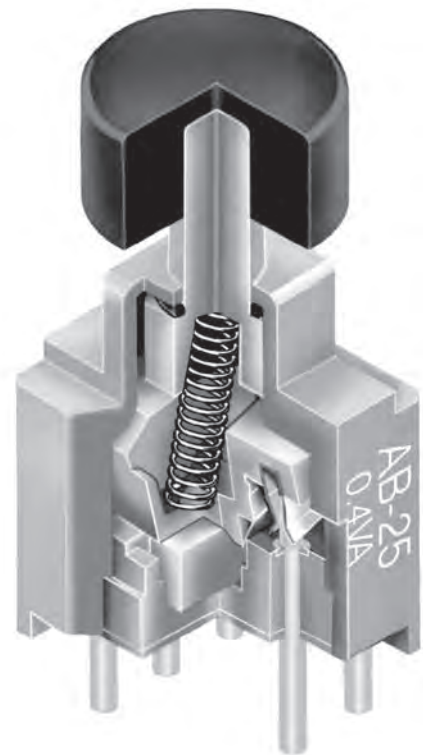

Actual Size

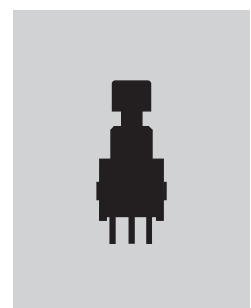

- Toggle
- Rockers
- Pushbuttons**
- Illuminated PB
- Programmable
- Key locks
- Rotaries
- Slides
- Tactiles
- Tilt
- Touch
- Indicators
- Accessories
- Supplement

### TYPICAL SWITCH ORDERING EXAMPLE

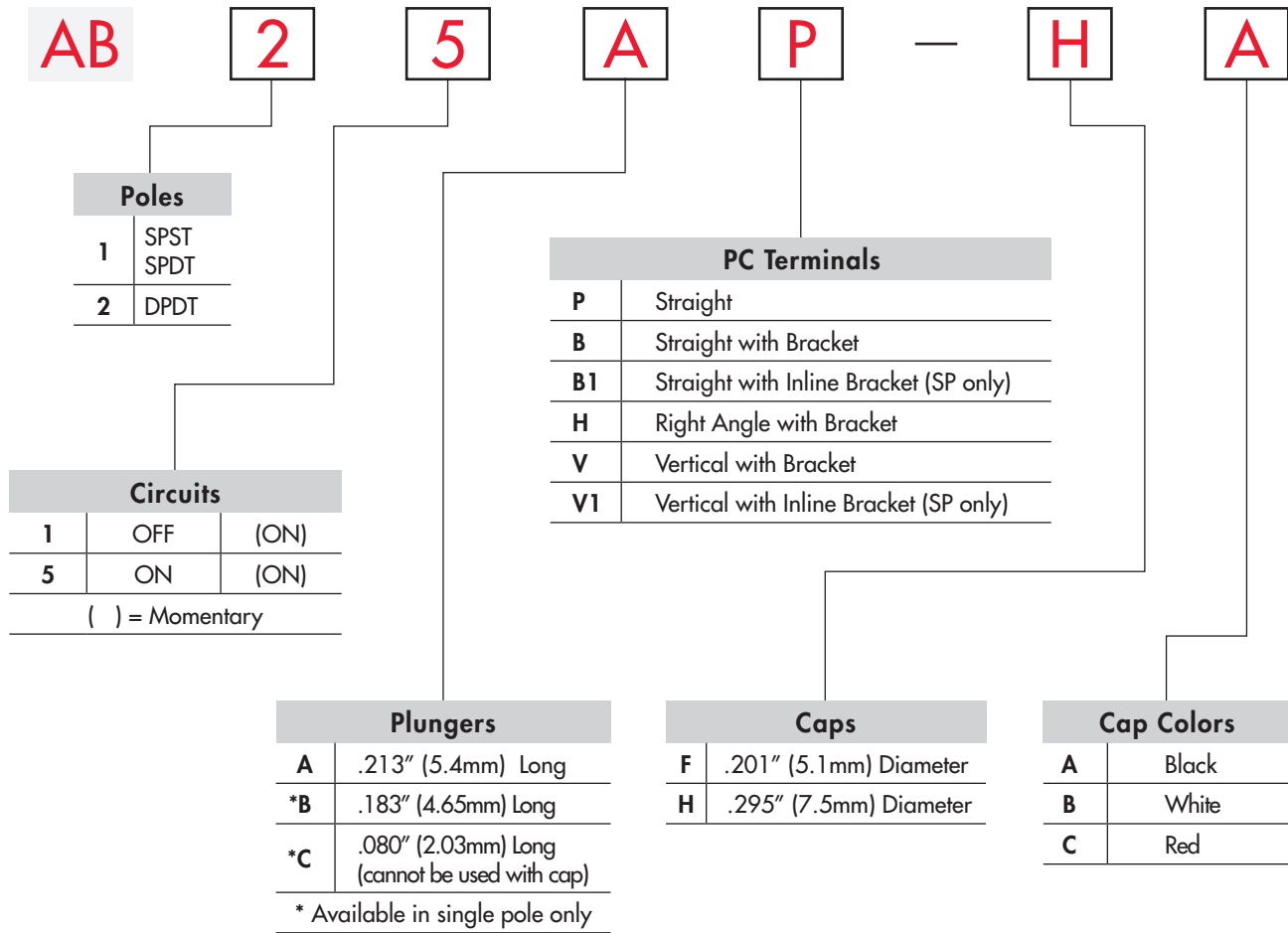

### DESCRIPTION FOR TYPICAL ORDERING EXAMPLE

#### AB25AP-HA

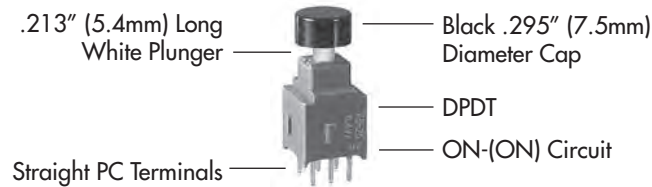



## POLES & CIRCUITS

Pole	Model	Plunger Position ( ) = Momentary		Connected Terminals		Throw & Schematics
		Normal	Down	Normal	Down	
SP	AB11	OFF 	(ON) 	OPEN 	3-1 	Note: Terminal numbers are not actually on the switch. SPST
SP	AB15	ON 	(ON) 	2-3 	2-1 	SPDT
DP	AB25	ON 	(ON) 	2-3 5-6 	2-1 5-4 	DPDT

## PLUNGERS

**A** .213" (5.4mm)  
Long

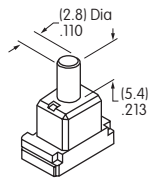

**B** .183" (4.6mm)  
Long  
(on SP only)

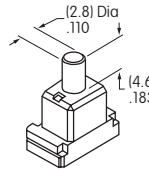

**C** .080" (2.03mm)  
Long  
(on SP only)

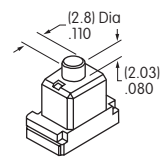

Standard Plunger Color: White Contact factory for red or black options.

## PC TERMINALS

**P** Straight

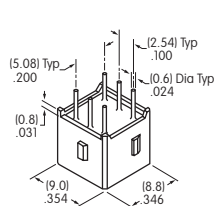

**B** Straight  
with Bracket

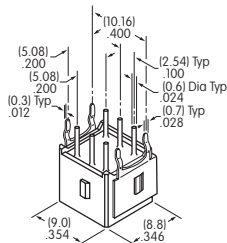

**H** Right Angle  
with Bracket

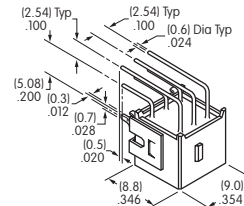

**V** Vertical  
with Bracket

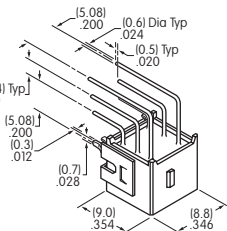

Use of a support bracket is recommended to increase PCB mounting strength and stability.  
B1 & V1 terminal dimensions appear on the pushbutton drawings which follow.

## SLIP-ON CAPS

**F** AT475  
.201" (5.1mm) Diameter Cap

Material: Polyamide  
For use with  
plungers A & B only.

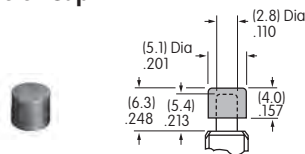

**H** AT496  
.295" (7.5mm) Diameter Cap

Material: Polyamide  
For use with  
plungers A & B only.

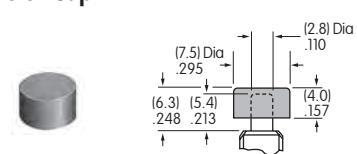

Colors Available:

**A** Black

**B** White

**C** Red

## TYPICAL SWITCH DIMENSIONS

### Straight PC

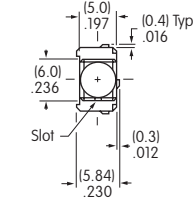

### Single Pole

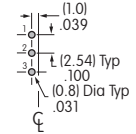
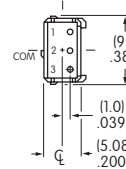
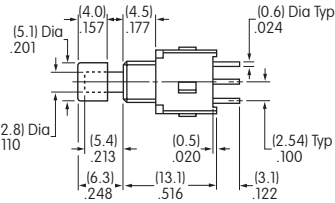

AB15AP-FA

AB11 model does not have terminal 2.

### Straight PC

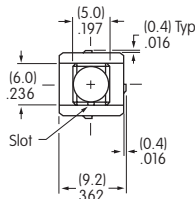

### Double Pole

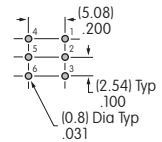
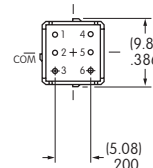
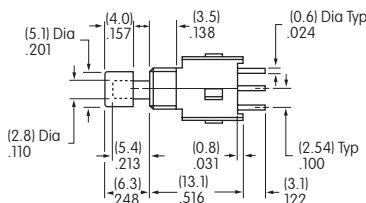

AB25AP-FA

### Straight PC • Bracket

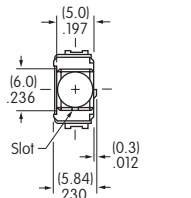

### Single Pole

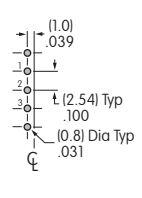
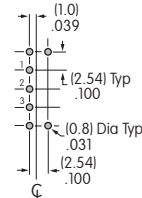
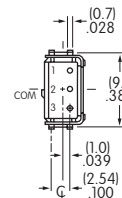
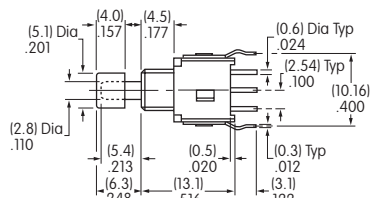

AB15AB-FA

B Terminals

B1 Terminals

### Straight PC • Bracket

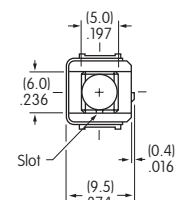

### Double Pole

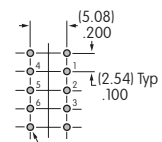
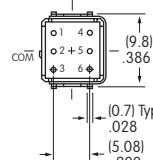
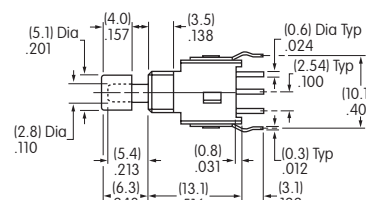

AB25AB-FA

### Right Angle PC

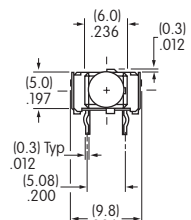

### Single Pole (Single Throw)

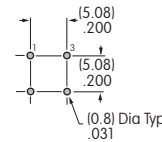
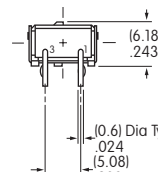
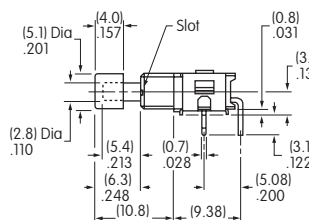

AB11AH-FA

Toggles  
Rockers  
Pushbuttons  
Illuminated PB  
Programmable  
Keylocks  
Rotaries  
Slides  
Tactiles  
Tilt  
Touch  
Indicators  
Accessories  
Supplement

## TYPICAL SWITCH DIMENSIONS

### Single Pole (Double Throw)

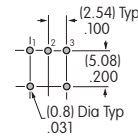
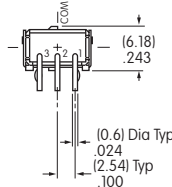
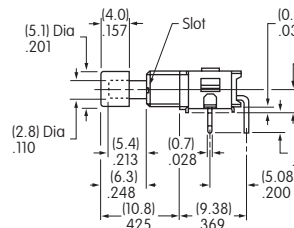
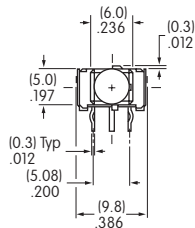

### Right Angle PC



**AB15AH-FA**

### Double Pole

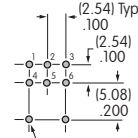
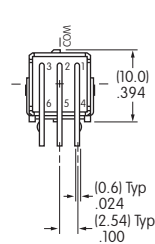
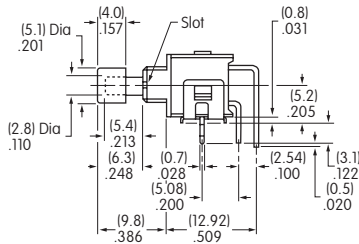
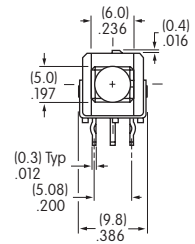

### Right Angle PC



**AB25AH-FA**

### Single Pole

### Vertical PC • Inline Bracket

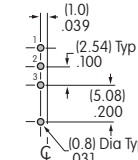
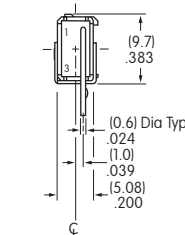
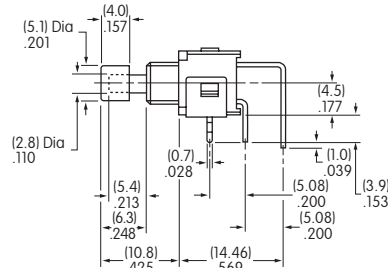
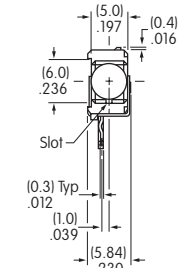

AB11 model does not have terminal 2. **AB11AV1-FA**

### Single Pole

### Vertical PC

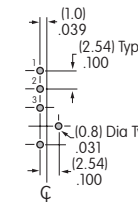
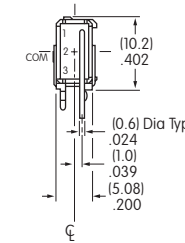
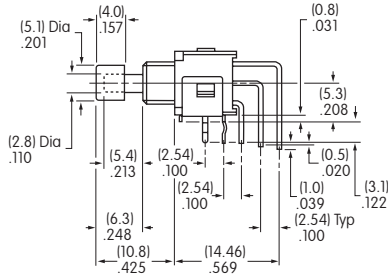
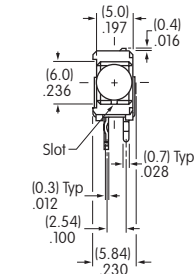

AB11 model does not have terminal 2. **AB15AV-FA**

### Double Pole

### Vertical PC

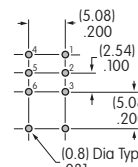
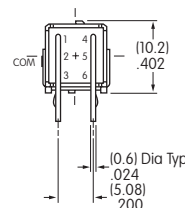
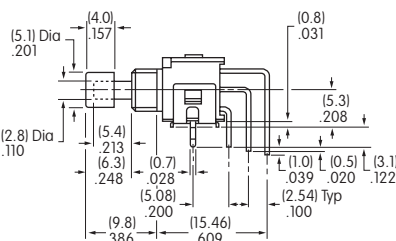
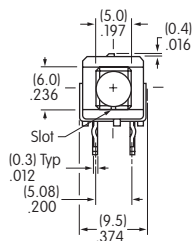

**AB25AV-FA**

# General Specifications

## Electrical Capacity (Resistive Load)

**Logic Level:** 0.4VA maximum @ 28V AC/DC maximum  
(Applicable Range 0.1mA ~ 0.1A @ 20mV ~ 28V)  
Note: Find additional explanation of operating range in Supplement section.

## Other Ratings

**Contact Resistance:** 50 milliohms maximum  
**Insulation Resistance:** 500 megohms minimum @ 500V DC  
**Dielectric Strength:** 500V AC minimum for 1 minute minimum  
**Mechanical Life:** 50,000 operations minimum (momentary)  
 25,000 operations minimum (alternate action)  
**Electrical Life:** 50,000 operations minimum (momentary)  
 25,000 operations minimum (alternate action)  
**Nominal Operating Force:** 2.55N (momentary); 2.94N (alternate action)  
**Contact Timing:** Nonshorting  
**Travel:** Momentary: Pretravel .028" (0.7mm); Overtravel .016" (0.4mm); Total Travel .043" (1.1mm)  
 Alternate: Pretravel .039" (1.0mm); Overtravel .039" (1.0mm); Total Travel .079" (2.0mm)

## Materials & Finishes

**Plunger:** Polyacetal  
**Bushing:** Carbon blended polyamide  
**Case Housing:** Glass fiber reinforced polyamide  
**Support Bracket:** Tin plated phosphor bronze  
**Movable Contact:** Phosphor bronze with gold plating  
**Stationary Contacts:** Copper alloy with gold plating  
**Terminals:** Copper alloy with gold plating

## Environmental Data

**Operating Temp Range:** -30°C through +85°C (-22°F through +185°F)  
**Humidity:** 90 ~ 95% humidity for 96 hours @ 40°C (104°F)  
**Vibration:** 10 ~ 55Hz with peak-to-peak amplitude of 1.5mm traversing the frequency range & returning in 1 minute; 3 right angled directions for 2 hours  
**Shock:** 50G (490m/s<sup>2</sup>) acceleration (tested in 6 right angled directions, with 5 shocks in each direction)

## Installation

**Cap Installation Force:** 49.03N (11.2 lbf) maximum downward force on actuator;  
actuator must be in UP position to remove cap from alternate action models

## PCB Processing

**Soldering:** Wave Soldering Recommended: See Profile A in Supplement section.  
Manual Soldering: See Profile B in Supplement section.  
**Cleaning:** Automated cleaning. See Cleaning specifications in Supplement section.

## Standards & Certifications

**Flammability Standards:** UL94V-0 available  
The BB Series pushbuttons have not been tested for UL recognition or CSA certification. These switches are designed for use in a low-voltage, low-current, logic-level circuit. When used as intended in a logic-level circuit, the results do not produce hazardous energy.

# Distinctive Characteristics

Subminiature size (1/3 size of Series M switches) saves space on PC boards.

Specifically developed for logic-level applications.

Available in momentary and maintained circuits.

Industry's smallest alternate action (maintained) pushbutton with latchdown feature providing visible, audible, and tactile feedback.

Antistatic superstructure, consisting of the carbon impregnated bushing and the support bracket, prevents static discharge to the contacts. Static electricity from an operator's touch travels from the actuator through the bushing and bracket to the PC board.

Award-winning STC contact mechanism with benefits unavailable in conventional mechanisms: smoother, positive detent actuation, increased contact stability and unparalleled logic-level reliability. (Additional STC details in Terms & Acronyms; see Supplement section.)

Smooth, 6mm diameter bushing simplifies panel layout.

Totally sealed body construction prevents contact contamination and allows time- and money-saving soldering and cleaning.

.100" x .100" (2.54mm x 2.54mm) terminal spacing conforms to standard PC board grids.

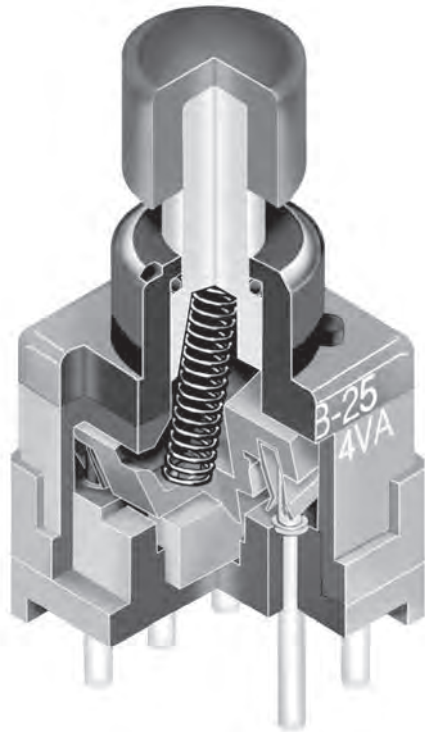

Actual Size

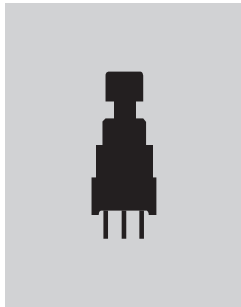

Supplement  
Accessories  
Indicators  
Touch  
Tilt  
Tactiles  
Slides  
Rotaries  
Key locks  
Programmable  
Illuminated PB  
Pushbuttons  
Rockers  
Toggle

### TYPICAL SWITCH ORDERING EXAMPLE

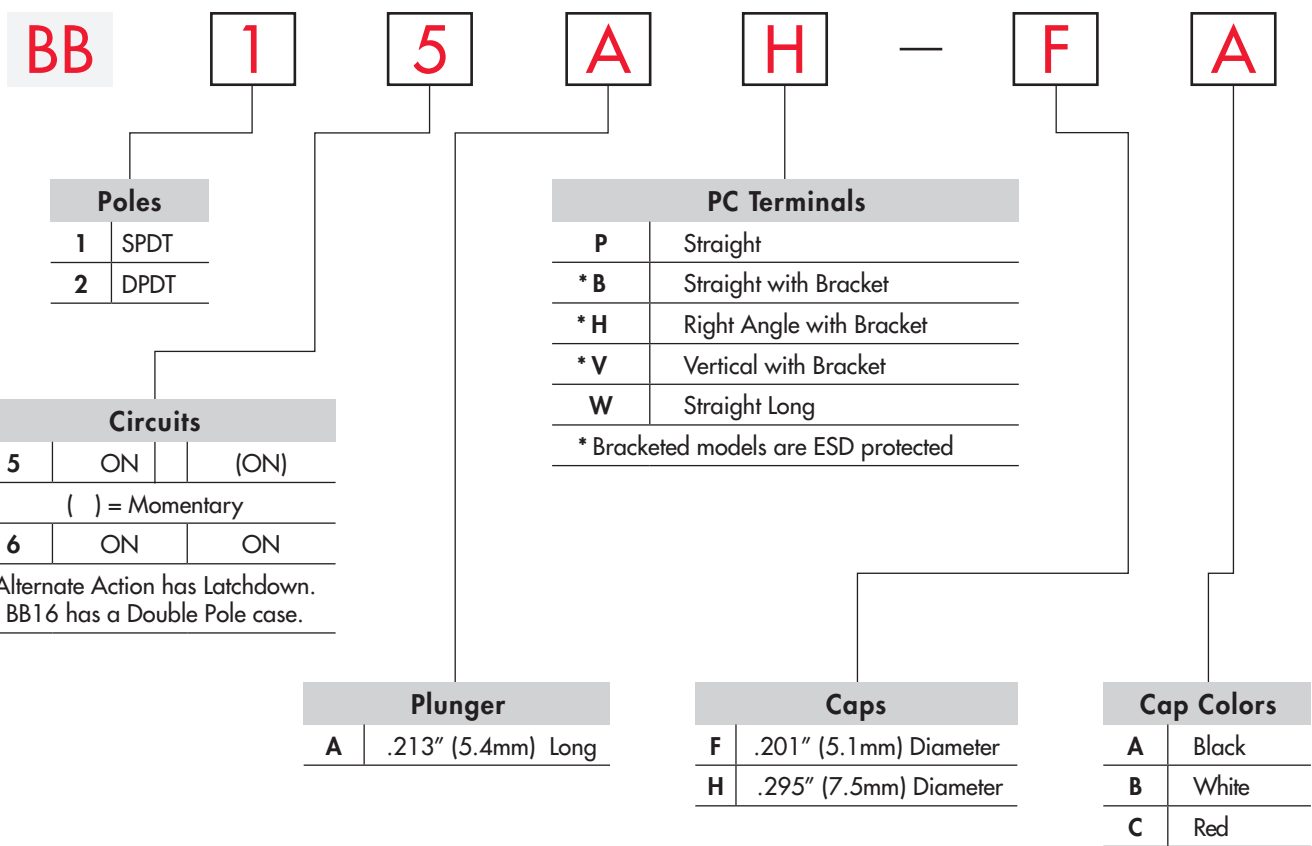

### DESCRIPTION FOR TYPICAL ORDERING EXAMPLE

#### BB15AH-FA

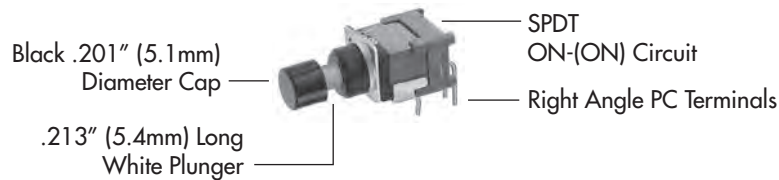

Toggles  
 Rockers  
 Pushbuttons  
 Illuminated PB  
 Programmable  
 Keylocks  
 Rotaries  
 Slides  
 Tactiles  
 Tilt  
 Touch  
 Indicators  
 Accessories  
 Supplement

## POLES & CIRCUITS

Pole	Model	Plunger Position ( ) = Momentary		Connected Terminals		Throw & Schematics
		Normal	Down	Normal	Down	
SP	BB15 BB16	ON ON	(ON) ON	2-3	2-1	SPDT 
DP	BB25 BB26	ON ON	(ON) ON	2-3 5-6	2-1 5-4	DPDT 

## PLUNGERS

**A** .213" (5.4mm) Long

Standard Plunger Color: White

Contact factory for other colors and lengths.

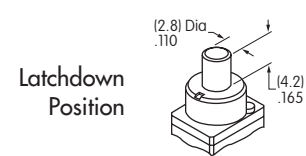
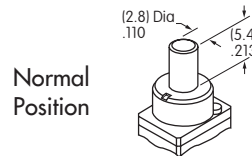

## PC TERMINALS

Use of a support bracket is recommended to increase PCB mounting strength and stability.

Both single pole and double pole alternate action models have double pole bases.

See Typical Switch Dimensions for details.

**P** Straight

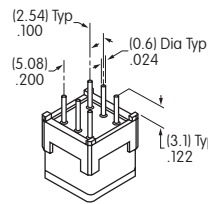

**B** Straight with Bracket

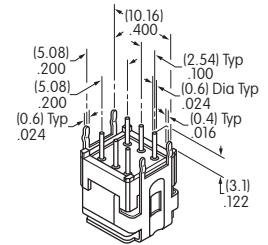

**H** Right Angle with Bracket

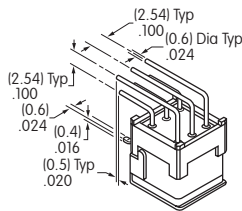

**V** Vertical with Bracket

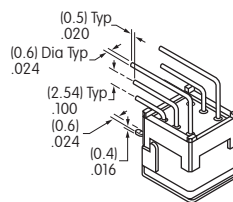

**W** Straight Long

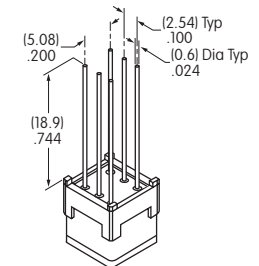

## SLIP-ON CAPS

**F** AT475  
.201" (5.1mm) Diameter Cap

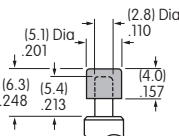

Material: Polyamide

**H** AT496  
.295" (7.5mm) Diameter Cap

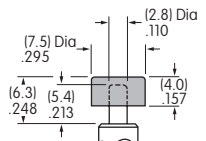

Material: Polyamide

Colors Available:

**A** Black

**B** White

**C** Red

## TYPICAL SWITCH DIMENSIONS

### Straight PC

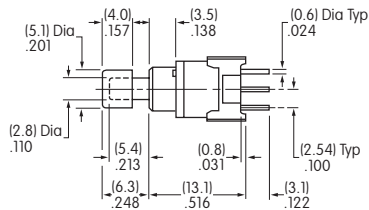
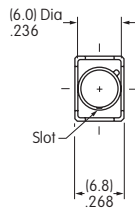

### Single Pole

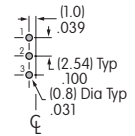
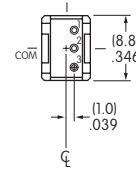

**BB15AP-FA**

Momentary

### Straight PC

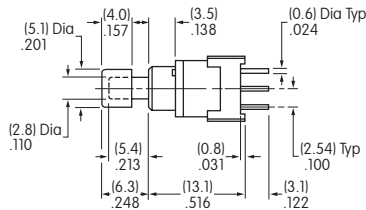
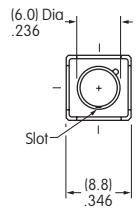

### Double Pole

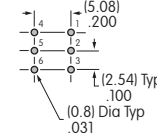
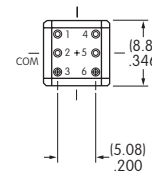

### BB16AP

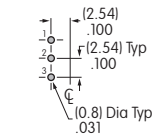
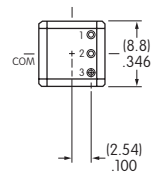

**BB25AP-FA**

Momentary & Alternate

Alternate

### Straight PC • Bracket

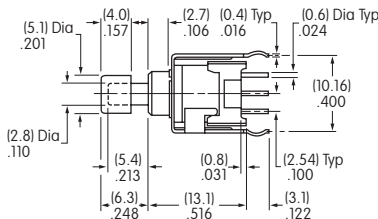
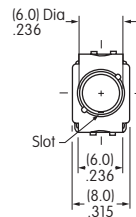

### Single Pole

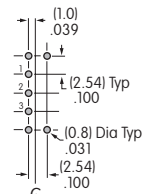
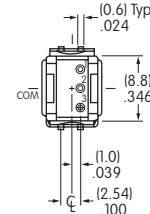

**BB15AB-FA**

Momentary

### Straight PC • Bracket

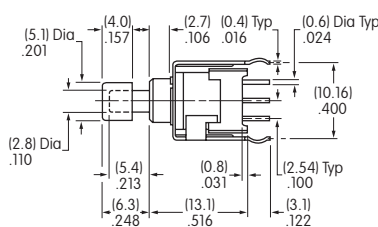
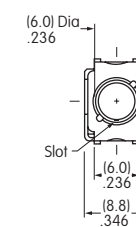

### Double Pole

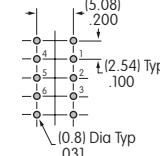
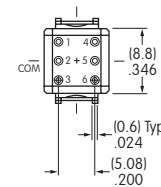

### BB16AB

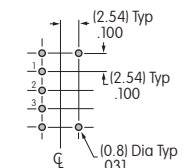
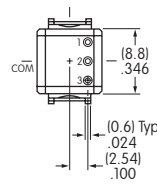

**BB25AB-FA**

Momentary & Alternate

Alternate



## TYPICAL SWITCH DIMENSIONS

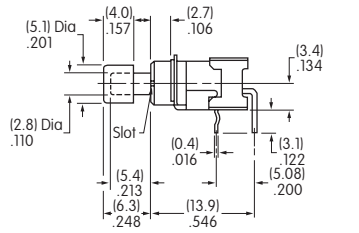
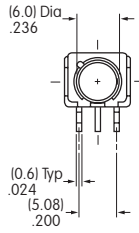

Single Pole

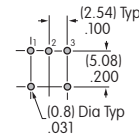
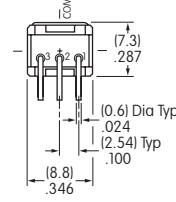

Momentary

Right Angle PC



BB15AH-FA

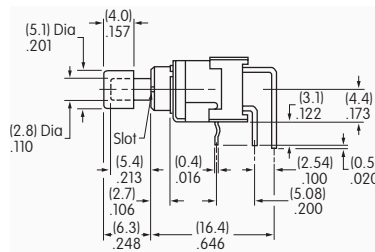
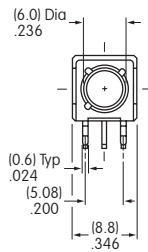

Double Pole

BB16AH

Right Angle PC

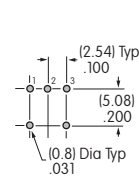
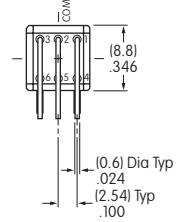

Momentary & Alternate

Alternate

BB25AH-FA

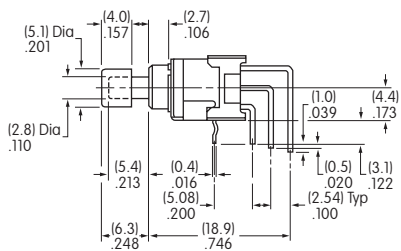
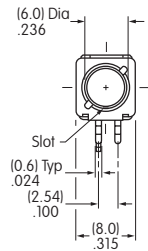

Single Pole

Vertical PC

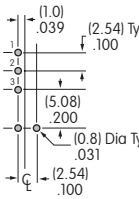
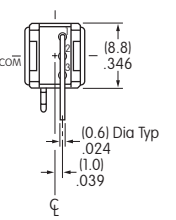

Momentary

BB15AV-FA

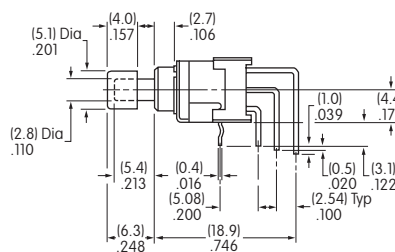
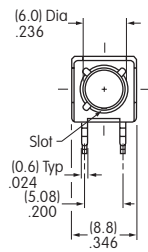

Double Pole

BB16AV

Vertical PC

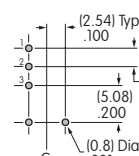
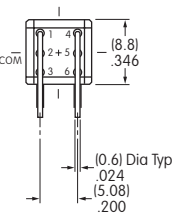

Momentary & Alternate

Alternate

BB25AV-FA



# General Specifications

## Electrical Capacity (Resistive Load)

**Logic Level:** 0.4VA maximum @ 28V AC/DC maximum  
(Applicable Range 0.1mA ~ 0.1A @ 20mV ~ 28V)  
Note: Find additional explanation of operating range in Supplement section.

## Other Ratings

**Contact Resistance:** 50 milliohms maximum  
**Insulation Resistance:** 1,000 megohms minimum @ 500V DC  
**Dielectric Strength:** 1,000V AC minimum between contacts for 1 minute minimum;  
1,500V AC minimum between contacts & case for 1 minute minimum

**Mechanical Life:** 200,000 operations minimum  
**Electrical Life:** 100,000 operations minimum

**Nominal Operating Force:** Single Pole: 1.96N  
Double Pole: 2.94N  
**Travel:** Pretravel .020" (0.5mm); Overtravel .020" (0.5mm); Total Travel .039" (1.0mm)

## Materials & Finishes

**Plunger:** Brass with nickel plating  
**Bushing:** Brass with nickel plating  
**Frame:** Stainless steel  
**Case:** Glass fiber reinforced polyamide  
**Movable Contacts:** Copper with gold plating  
**Stationary Contacts:** Phosphor bronze with gold plating  
**Terminals:** Brass with gold plating

## Environmental Data

**Operating Temp Range:** -10°C through +70°C (+14°F through +158°F)  
**Humidity:** 90 ~ 95% humidity for 96 hours @ 40°C (104°F)  
**Vibration:** 10 ~ 55Hz with peak-to-peak amplitude of 1.5mm traversing the frequency range & returning in 1 minute; 3 right angled directions for 2 hours  
**Shock:** 50G (490m/s<sup>2</sup>) acceleration (tested in 6 right angled directions, with 5 shocks in each direction)

## Installation

**Mounting Torque:** 1.47Nm (13.0 lb•in) for double nut; 0.68Nm (6.0 lb•in) for single nut  
**Cap Installation Force:** 78.5N (17.65 lbf) maximum downward force on actuator

## PCB Processing

**Soldering:** Wave Soldering Recommended. See Profile A in Supplement section.  
Manual Soldering: See Profile B in Supplement section.  
**Cleaning:** These devices are not process sealed. Hand clean locally using alcohol based solution.

## Standards & Certifications

The DB Series pushbuttons have not been tested for UL recognition or CSA certification. These switches are designed for use in low-voltage, low-current, logic-level circuit. When used as intended in a logic-level circuit, the results do not produce hazardous energy.

# Distinctive Characteristics

Both PCB and panel mounting options available.

Choice of cap sizes in .315" (8.0mm) and .394" (10.0mm) diameter cap design for simple, snap-on installation.

High torque bushing prevents rotation and separation from metal frame during installation.

Stainless steel frame resists corrosion.

Snap action contacts give smooth actuation, short stroke, light touch, and audible feedback. This mechanism also provides long mechanical life.

Molded-in terminals prevent entry of solder flux, dust, and other contaminants.

.100" x .100" (2.54mm x 2.54mm) terminal spacing conforms to standard PC board grid spacing. Round terminals for easier through-hole mounting on PC boards.

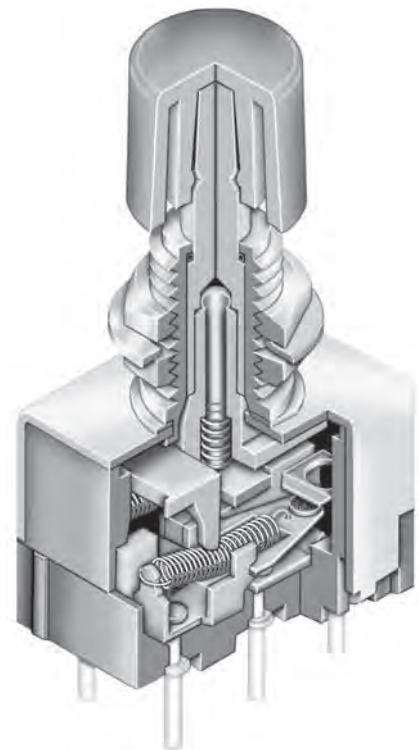

Actual Size

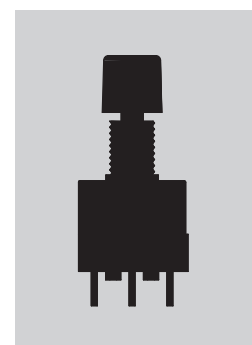

- Supplement
- Accessories
- Indicators
- Touch
- Tilt
- Tactiles
- Slides
- Rotaries
- Key locks
- Programmable
- Illuminated PB
- Pushbuttons
- Rockers
- Toggle

### TYPICAL SWITCH ORDERING EXAMPLE

**DB25**

**21**

**B**

#### Poles & Circuits

11	SPDT	ON	(ON)
21	DPDT	ON	(ON)
( ) = Momentary			

#### PC Terminals

Threaded Bushing	
P	Straight
Smooth Bushing	
B	Straight with Bracket
H	Right Angle with Bracket
V	Vertical with Bracket

### DESCRIPTION FOR TYPICAL ORDERING EXAMPLE

**DB2521B with AT443E Cap**

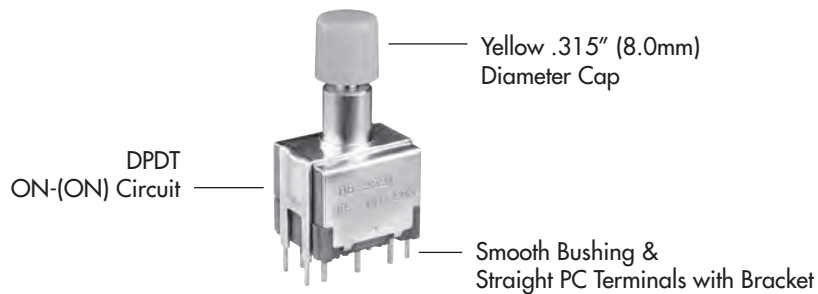

### POLES & CIRCUITS

Pole	Model	Plunger Position ( ) = Momentary		Connected Terminals		Throw & Switch Schematics
		Normal 	Down 	Normal 	Down 	
SP	DB2511	ON	(ON)	3-1	3-2	SPDT 
DP	DB2521	ON	(ON)	3-1 6-4	3-2 6-5	DPDT 

## TYPICAL SWITCH DIMENSIONS

### Single Pole

### Straight PC

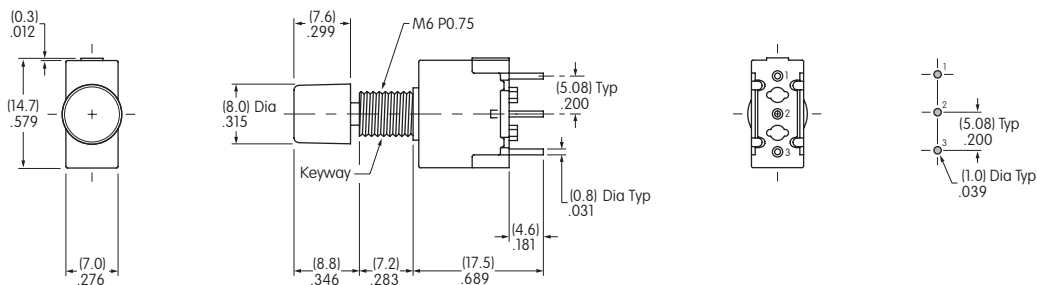

DB2511P with AT443C

### Double Pole

### Straight PC

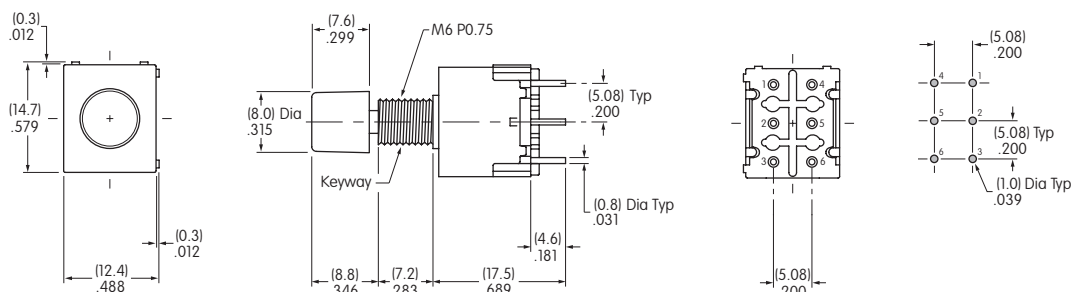

DB2521P with AT442A

### Single Pole

### Straight PC with Bracket

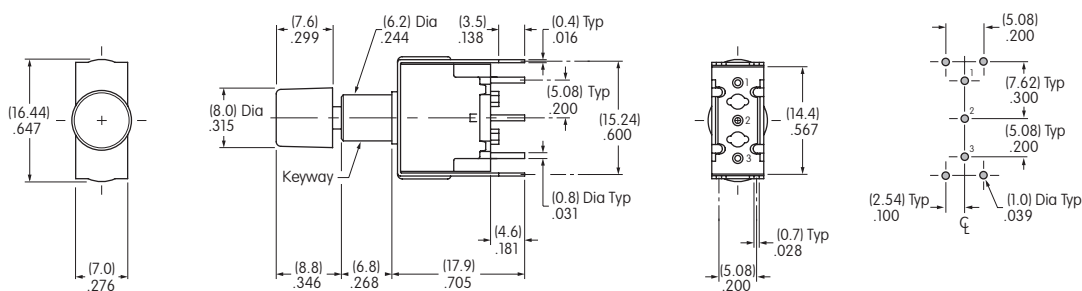

DB2511B with AT442C

### Double Pole

### Straight PC with Bracket

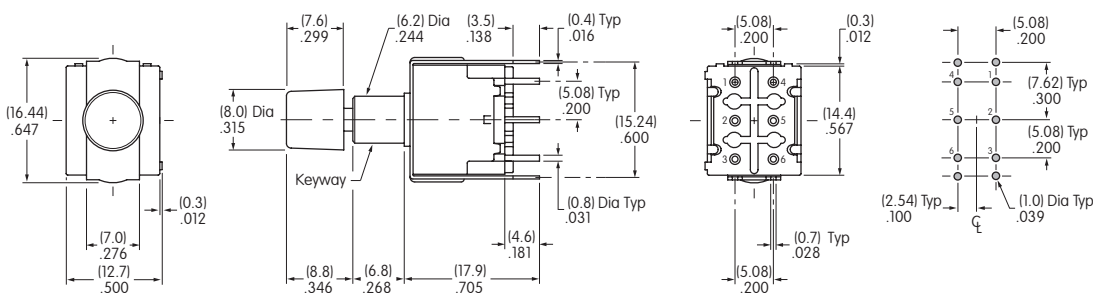

DB2521B with AT443E

## TYPICAL SWITCH DIMENSIONS

### Right Angle PC with Bracket

### Single Pole

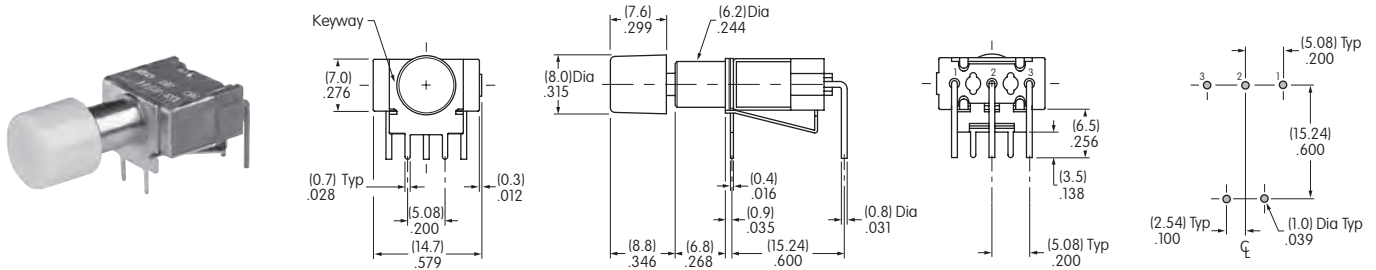

DB2511H with AT442B

### Right Angle PC with Bracket

### Double Pole

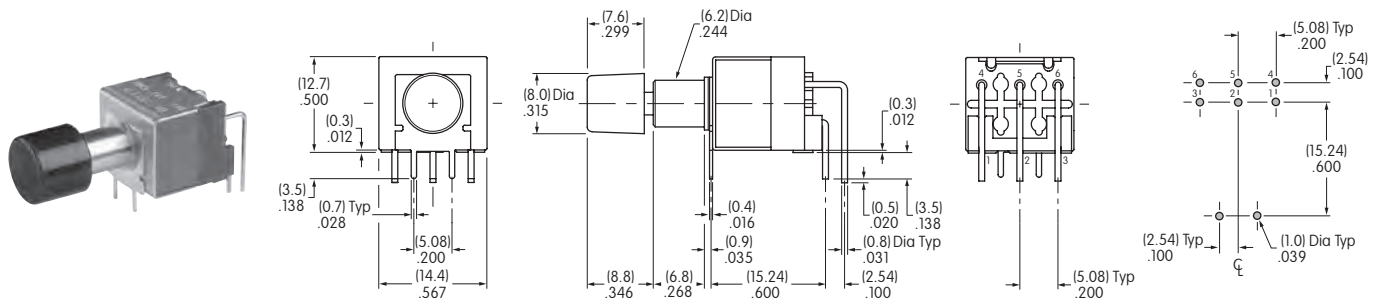

DB2521H with AT442A

### Vertical PC with Bracket

### Single Pole

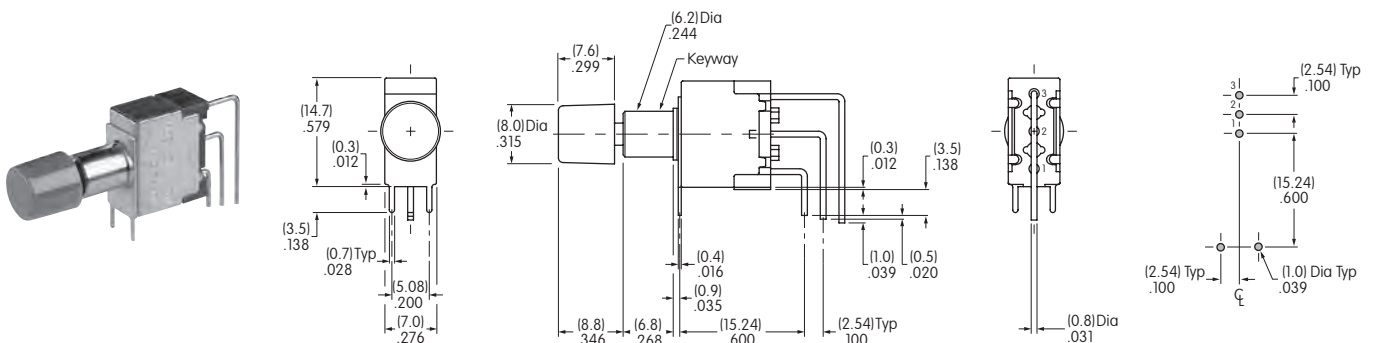

DB2511V with AT443C

### Vertical PC with Bracket

### Double Pole

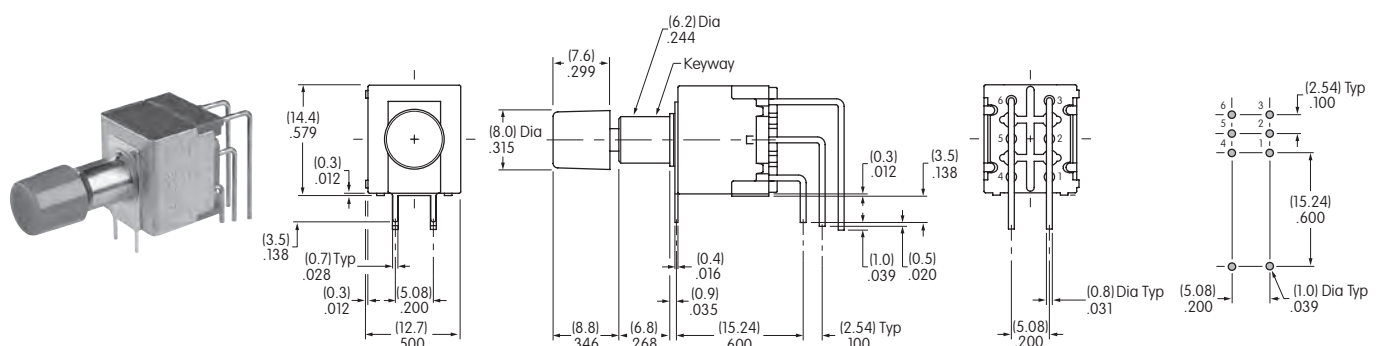

DB2521V with AT443C

## OPTIONAL CAPS & COLORS

### AT443 .315" (8.0mm) Diameter Snap-on Cap

Cap Colors Available:

- A** Black
- E** Yellow
- B** White
- F** Green
- C** Red
- G** Blue

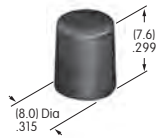

Cap Material: Polycarbonate Finish: Glossy

### AT442 .394" (10.0mm) Diameter Snap-on Cap

Cap Colors Available:

- A** Black
- E** Yellow
- B** White
- F** Green
- C** Red
- G** Blue



Cap Material: Polycarbonate Finish: Glossy

## HARDWARE

### Standard Hardware

#### AT513M Metric Hexagon Nut

Material: Brass with Nickel Plating

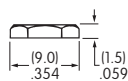
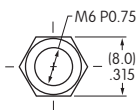

#### AT509 Lockwasher

Material: Steel with Zinc/Chromate

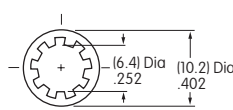

### Optional Hardware

#### AT507M Metric Locking Ring

Material: Steel with Zinc/Chromate

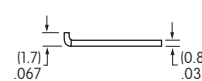
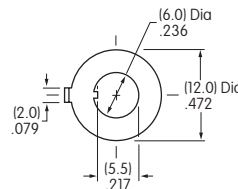

#### AT501M Metric Knurled Face Nut

Material: Brass with Chrome Plating

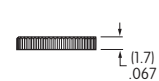
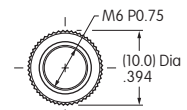

## INSTALLATION/ASSEMBLY

- 2 AT513M Metric Hexagon Nuts
- 1 AT509 Internal Tooth Lockwasher

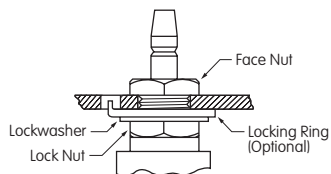

Optional Hardware:  
AT507M Metric Locking Ring

Note: Cap must be snapped on after the switch is mounted into the panel.

## PANEL CUTOUTS & THICKNESSES

### With Standard Hardware

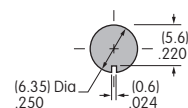

Maximum Effective Panel Thickness: .118" (3.0mm)

### Without Bottom Hex Nut

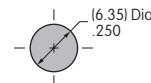

Maximum Effective Panel Thickness: .185" (4.7mm)

### With Standard Hardware & Optional Locking Ring

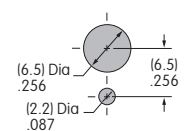

Maximum Effective Panel Thickness: .087" (2.2mm)

# General Specifications

## Electrical Capacity (Resistive Load)

<b>Power Level (silver):</b>	3A @ 125V AC for silver contacts
<b>Logic Level (gold):</b>	0.4VA maximum @ 28V AC/DC maximum for gold contacts (Applicable Range 0.1mA ~ 0.1A @ 20mV ~ 28V) Note: Find additional explanation of operating range in Supplement section.

## Other Ratings

<b>Contact Resistance:</b>	10 milliohms maximum for silver; 20 milliohms maximum for gold
<b>Insulation Resistance:</b>	1,000 megohms minimum @ 500V DC
<b>Dielectric Strength:</b>	1,000V AC minimum between contacts for 1 minute minimum; 1,500V AC minimum between contacts and case for 1 minute minimum
<b>Mechanical Life:</b>	100,000 operations minimum
<b>Electrical Life:</b>	25,000 operations minimum for silver; 50,000 operations minimum for gold
<b>Nominal Operating Force:</b>	Single Pole: 2.35N for Momentary and 2.65N for Alternate Action Double Pole: 2.94N for Momentary and 3.63N for Alternate Action
<b>Travel:</b>	Momentary: Pretravel .047" (1.2mm); Overtravel .016" (0.4mm); Total Travel .063" (1.6mm) Alternate: Pretravel .071" (1.8mm); Overtravel .016" (0.4mm); Total Travel .087" (2.2mm)

## Materials & Finishes

<b>Plunger:</b>	Brass with nickel plating
<b>Bushing:</b>	Brass with nickel plating
<b>Frame:</b>	Stainless steel
<b>Case:</b>	Melamine phenolic resin (UL94V-0)
<b>Movable Contacts:</b>	Copper with silver or gold plating
<b>Stationary Contacts:</b>	Silver & copper with silver or gold plating
<b>Terminals:</b>	Copper with silver or gold plating

## Environmental Data

<b>Operating Temp Range:</b>	-10°C through +70°C (+14°F through +158°F)
<b>Humidity:</b>	90 ~ 95% humidity for 96 hours @ 40°C (104°F)
<b>Vibration:</b>	10 ~ 55Hz with peak-to-peak amplitude of 1.5mm traversing the frequency range & returning in 1 minute; 3 right angled directions for 2 hours
<b>Shock:</b>	50G (490m/s <sup>2</sup> ) acceleration (tested in 6 right angled directions, with 5 shocks in each direction)

## Installation

<b>Mounting Torque:</b>	1.47Nm (13.0 lb•in) for double nut; 0.68Nm (6.0 lb•in) for single nut
<b>Cap Installation Force:</b>	78.5N (17.65 lbf) maximum downward force on actuator
<b>Soldering Time &amp; Temp:</b>	Wave Solder (Straight PC): See Profile B in Supplement section. Manual Soldering: See Profile B in Supplement section.
<b>Cleaning:</b>	These devices are not process sealed. Hand clean locally using alcohol based solution.

## Standards & Certifications

<b>Flammability Standards:</b>	UL94V-0 case
<b>UL:</b>	<b>File No. E44145 - Recognized only when ordered with marking on switch.</b> Add "/U" or "/CUL" before first dash in part number to order UL recognized switch. All single and double pole models recognized at 3A @ 125V AC.
<b>CSA:</b>	<b>File No. 023535_0_000 - Certified only when ordered with marking on switch.</b> Add "/C" before first dash in part number to order CSA certified switch. Single pole solder lug and PC models certified at 3A @ 125V AC; double pole PC models certified at 3A @ 125V AC.



# Distinctive Characteristics

Power and logic level capabilities available to suit varying applications.

Bushing and snap-in mount versions available; snap-in models offer many style and color choices to enhance front panel appearance.

Light touch actuation.

High torque bushing prevents rotation and separation from metal frame during installation.

Stainless steel frame resists corrosion.

Case of heat resistant resin meets UL 94V-0 flammability rating.

Higher insulating barriers protect against crossover in double pole devices.

1,500V dielectric strength between contacts and case is accomplished by clinching the frame away from the terminals.

Epoxy sealed terminals prevent entry of solder flux and other contaminants.

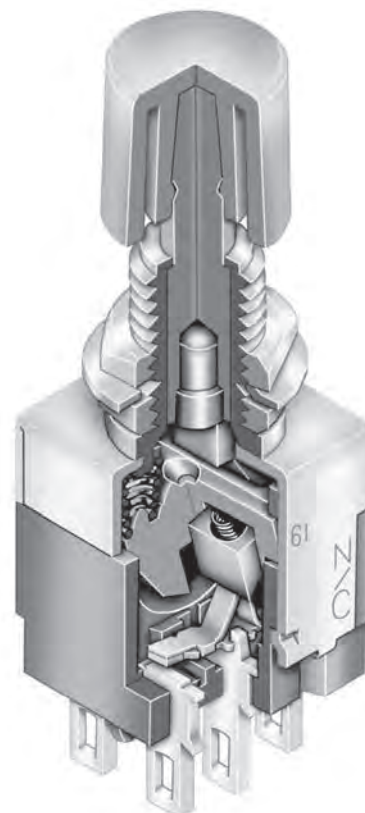

Actual Size

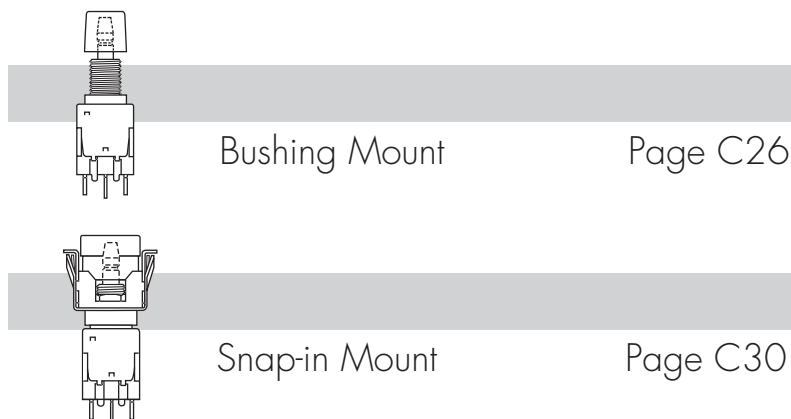
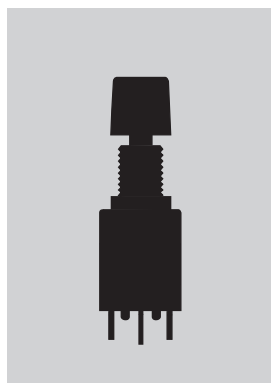

- Toggle
- Rockers
- Pushbuttons**
- Illuminated PB
- Programmable
- Key locks
- Rotaries
- Slides
- Tactiles
- Tilt
- Touch
- Indicators
- Accessories
- Supplement

### TYPICAL SWITCH ORDERING EXAMPLE

**EB20**

**65**

**B**

**F**

#### Poles & Circuits

<b>11</b>	SPDT	ON	(ON)
<b>65</b>	SPDT	ON	ON
<b>61</b>	DPDT	ON	(ON)
<b>85</b>	DPDT	ON	ON

( ) = Momentary

#### Caps

<b>B</b>	.315" (8.0mm) Dia.
<b>C</b>	.394" (10.0mm) Dia.

#### Contacts, Ratings, & Terminals

<b>No Code</b>	Silver Contacts; Solder Lug Terminals 3A @ 125V AC
<b>G</b>	Gold Contacts; Solder Lug Terminals 0.4VA max @ 28V AC/DC max
<b>P</b>	Silver Contacts; Straight PC Terminals; 3A @ 125V AC
<b>PG</b>	Gold Contacts; Straight PC Terminals 0.4VA max @ 28V AC/DC max

#### Colors

<b>A</b>	Black
<b>B</b>	White
<b>C</b>	Red
<b>E</b>	Yellow
<b>F</b>	Green
<b>G</b>	Blue
<b>H</b>	Gray

#### IMPORTANT:





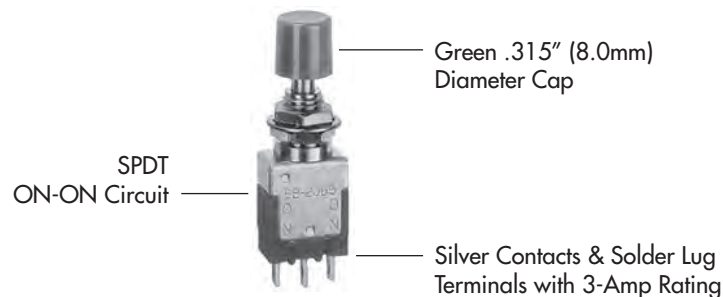

Switches are supplied without UL, cULus & CSA marking unless specified.  
**UL, cULus & CSA recognized only when ordered with marking on the switch.**  
 Specific models, ratings, & ordering instructions are noted on the General Specifications page.

#### DESCRIPTION FOR TYPICAL ORDERING EXAMPLE

**EB2065-BF**

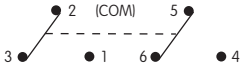

## POLES & CIRCUITS

Pole	Model	Plunger Position ( ) = Momentary		Connected Terminals		Throw & Switch Schematics
		Normal 	Down 	Normal 	Down 	
SP	EB2011 EB2065	ON ON	(ON) ON	2-3	2-1	SPDT 
DP	EB2061 EB2085	ON ON	(ON) ON	2-3 5-6	2-1 5-4	DPDT 

## CONTACT MATERIALS, RATINGS, & TERMINALS



Solder Lug  
Silver Contacts

Power Level

3A @ 125V AC



Solder Lug  
Gold Contacts

Logic Level

0.4VA max @ 28V AC/DC max

Complete explanation of operating range in Supplement section.

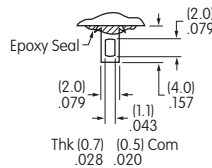

Straight PC  
Silver Contacts

Power Level

3A @ 125V AC



Straight PC  
Gold Contacts

Logic Level

0.4VA max @ 28V AC/DC max

Complete explanation of operating range in Supplement section.

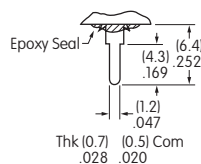

### PCB Footprints

Single Pole

Double Pole

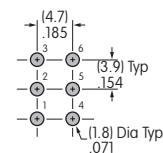
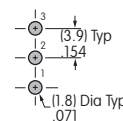

## CAPS & COLORS

**B** AT443  
.315" (8.0mm) Diameter Snap-on Cap

**C** AT442  
.394" (10.0mm) Diameter Snap-on Cap

Cap Colors Available:

- |                 |                |
|-----------------|----------------|
| <b>A</b> Black  | <b>F</b> Green |
| <b>B</b> White  | <b>G</b> Blue  |
| <b>C</b> Red    | <b>H</b> Gray  |
| <b>E</b> Yellow |                |

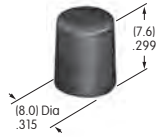

Cap Colors Available:

- |                 |                |
|-----------------|----------------|
| <b>A</b> Black  | <b>F</b> Green |
| <b>B</b> White  | <b>G</b> Blue  |
| <b>C</b> Red    | <b>H</b> Gray  |
| <b>E</b> Yellow |                |



Cap Material: Polycarbonate Finish: Glossy

Cap Material: Polycarbonate Finish: Glossy

### Plunger Extension

Due to a difference in plunger lengths on the momentary and alternate action models, cap distance from top of bushing varies.

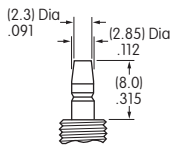

Momentary Plunger Length

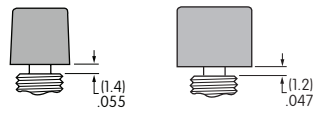

Momentary Cap Location

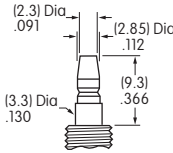

Alternate Plunger Length

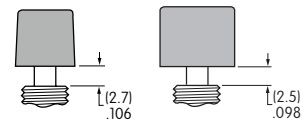

Alternate Cap Location

## TYPICAL SWITCH DIMENSIONS

### Solder Lug

### Single Pole



EB2011-BA

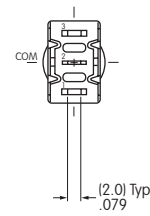
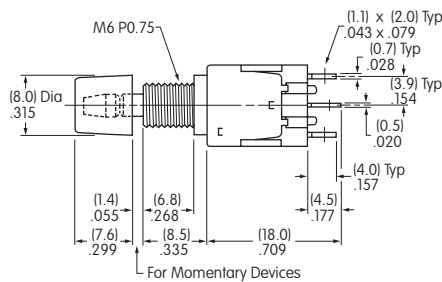
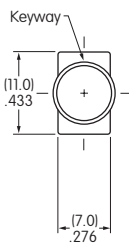

### Solder Lug

### Double Pole



EB2061-BA

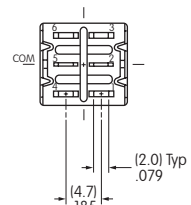
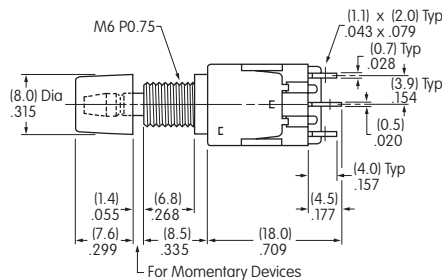
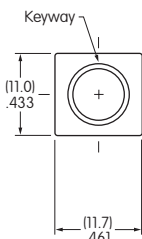

## HARDWARE

### Installation/Assembly

- 2 AT513M Metric Hexagon Nuts
- 1 AT509 Internal Tooth Lockwasher

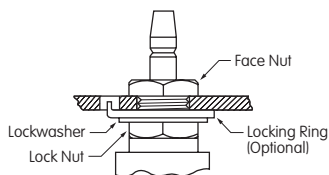

Optional Hardware:  
AT507M Metric Locking Ring

Note: Cap must be snapped on after the switch is mounted into the panel.

### Standard Hardware

#### AT513M Metric Hexagon Nut

Material:  
Brass with Nickel Plating

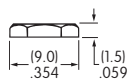
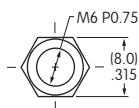

#### AT509 Lockwasher

Material:  
Steel with Zinc/Chromate

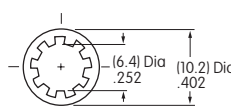

### Optional Hardware

#### AT507M Metric Locking Ring

Material:  
Steel with Zinc/Chromate

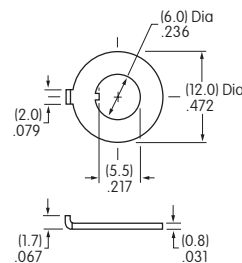

## PANEL CUTOUTS & THICKNESSES

### Metric Bushing

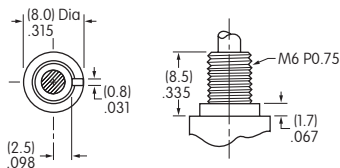

### With Standard Hardware

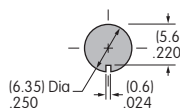

Maximum Effective Panel Thickness:  
.118" (3.0mm)

### With Standard Hardware & Optional Locking Ring

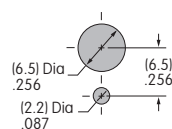

Maximum Effective Panel Thickness:  
.055" (1.4mm)

### Without Bottom Hex Nut

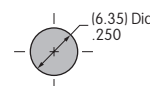

Maximum Effective Panel Thickness:  
.185" (4.7mm)

See Accessories & Hardware section for optional Conical Nuts:  
AT512M used with cap AT443 and AT512CM used with cap AT442.

Toggle

Rockers

Pushbuttons

Illuminated PB

Programmable

Keylocks

Rotaries

Slides

Tactiles

Tilt

Touch

Indicators

Accessories

Supplement

### TYPICAL SWITCH

EB20

11

B

J23

#### Poles & Circuits

11	SPDT	ON	(ON)
65	SPDT	ON	ON
61	DPDT	ON	(ON)
85	DPDT	ON	ON
( ) = Momentary			

#### Contacts, Ratings, & Terminals

<b>No Code</b>	Silver Contacts; Solder Lug Terminals 3A @ 125V AC
<b>G</b>	Gold Contacts; Solder Lug Terminals 0.4VA max @ 28V AC/DC max
<b>P</b>	Silver Contacts; Straight PC Terminals; 3A @ 125V AC
<b>PG</b>	Gold Contacts; Straight PC Terminals 0.4VA max @ 28V AC/DC max

#### Cap Colors

<b>A</b>	Black
<b>B</b>	White
<b>C</b>	Red
<b>E</b>	Yellow
<b>F</b>	Green
<b>G</b>	Blue
<b>H</b>	Gray

#### Cap Extensions & Bezel Types

Low Rise		High Rise		Description
Momen- tary	Alter- nate	Momen- tary	Alter- nate	
J20	J30	J40	J50	Without Bezel
J21	J31	J41	J51	Bezel without LED
J22	J32	J42	J52	Bezel with 1 Round LED
J23	J33	J43	J53	Bezel with 2 Round LEDs
J24	J34	J44	J54	Bezel with 2 Rectangular LEDs

#### IMPORTANT:

Switches are supplied without UL, cULus & CSA marking unless specified.

**UL, cULus & CSA recognized only when ordered with marking on the switch.**

Specific models, ratings, & ordering instructions are noted on the General Specifications page.

#### DESCRIPTION FOR TYPICAL ORDERING EXAMPLE WITHOUT BEZEL

**EB2011-A-J40**

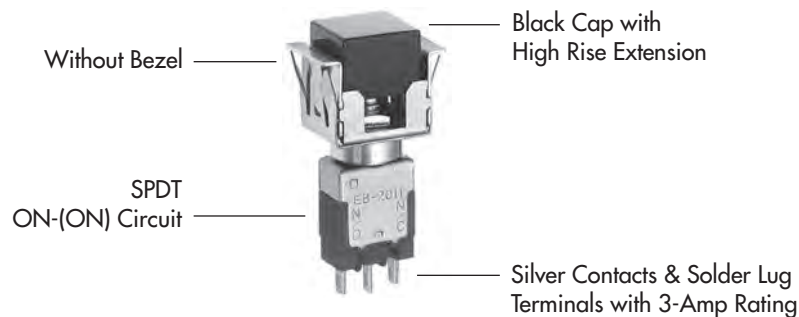

## ORDERING EXAMPLES

<b>A</b>				<b>C F</b>			
<b>Bezel Colors</b>				<b>Led Colors</b>			
<b>Bezel without LEDs</b>							
<b>A</b>	Black	<b>F</b>	Green				
<b>B</b>	White	<b>G</b>	Blue				
<b>C</b>	Red	<b>H</b>	Gray				
<b>E</b>	Yellow						
<b>Bezel with 1 Round LED</b>				<b>1 LED</b>			
<b>A</b>	Black			<b>C</b>	Red		
				<b>F</b>	Green		
<b>Bezel with 2 Round or Rectangular LEDs</b>				<b>2 LEDs</b>			
<b>A</b>	Black			<b>Top LED</b>		<b>Bottom LED</b>	
				<b>C</b>	Red	<b>C</b>	Red
				<b>E</b>	Yellow	<b>E</b>	Yellow
				<b>F</b>	Green	<b>F</b>	Green

### DESCRIPTION FOR TYPICAL ORDERING EXAMPLE WITH BEZEL

#### EB2011-B-J23ACF

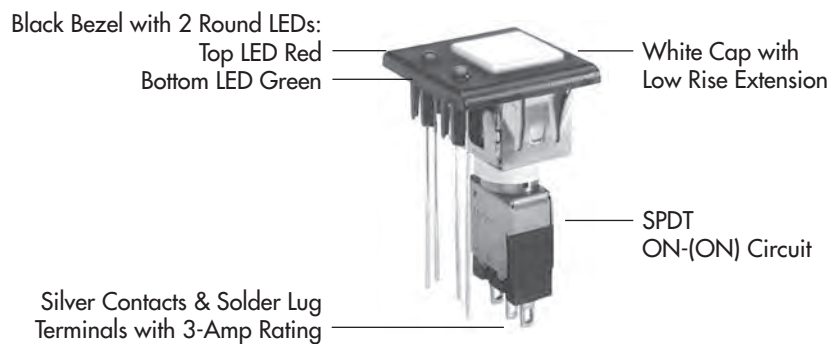

Toggles

Rockers

Pushbuttons

Illuminated PB

Programmable

Keylocks

Rotaries

Slides

Tactiles

Tilt

Touch

Indicators

Accessories

Supplement

### POLES & CIRCUITS

Pole	Model	Plunger Position ( ) = Momentary		Connected Terminals		Throw & Switch Schematics
		Normal	Down	Normal	Down	
						Note: Terminal numbers are not actually on the switch.
SP	EB2011 EB2065	ON ON	(ON) ON	2-3	2-1	SPDT
DP	EB2061 EB2085	ON ON	(ON) ON	2-3 5-6	2-1 5-4	DPDT

### CONTACT MATERIALS, RATINGS, & TERMINALS



**Solder Lug  
Silver Contacts**

**Power Level**

**3A @ 125V AC**



**Solder Lug  
Gold Contacts**

**Logic Level**

**0.4VA maximum @ 28V AC/DC maximum**

Complete explanation of operating range in Supplement section.

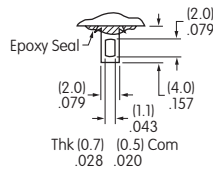

**Straight PC  
Silver Contacts**

**Power Level**

**3A @ 125V AC**



**Straight PC  
Gold Contacts**

**Logic Level**

**0.4VA maximum @ 28V AC/DC maximum**

Complete explanation of operating range in Supplement section.

#### PCB Footprints

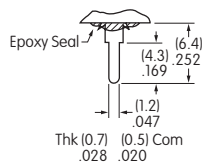

Single Pole

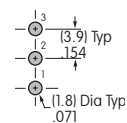

Double Pole

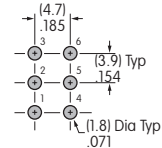



## CAP COLORS

Factory Assembled on the Switch:  
 Square snap-on cap AT465, snap-in mounter  
 AT529, and optional bezels which follow.

<b>A</b>	Black	<b>B</b>	White	<b>C</b>	Red	<b>E</b>	Yellow
<b>F</b>	Green	<b>G</b>	Blue	<b>H</b>	Gray		

## CAP EXTENSIONS & BEZEL TYPES

Cap Extension without Bezel

**J20**  
 Low Rise Momentary

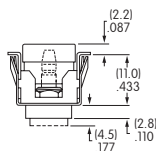

**J30**  
 Low Rise Alternate

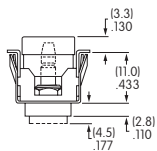

**J40**  
 High Rise Momentary

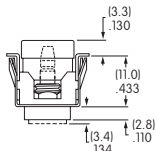

**J50**  
 High Rise Alternate

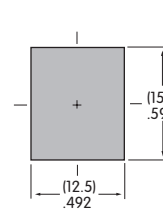
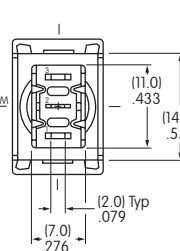
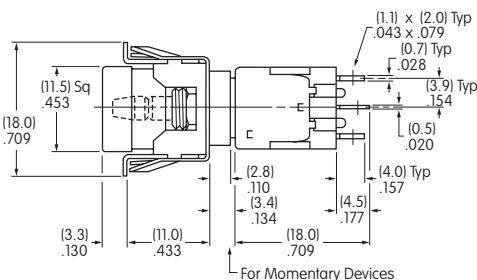
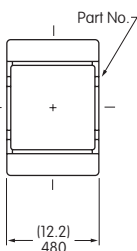
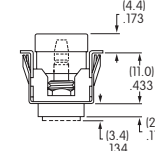

Maximum Panel Thickness  
 .039" ~ .157" (1.0mm ~ 4.0mm)  
 Cutout applies to SP & DP



High Rise

Single Pole

**EB2011-A-J40**

Cap Extension with Bezel

**J21**  
 Low Rise Momentary

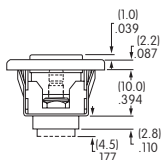

**J31**  
 Low Rise Alternate

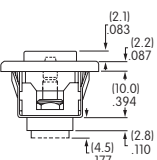

**J41**  
 High Rise Momentary

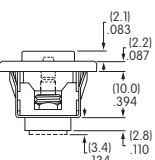

**J51**  
 High Rise Alternate

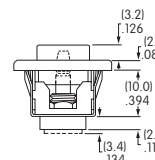

AT207 Bezel without LED

<b>E</b>	Yellow
<b>A</b>	Black
<b>B</b>	White
<b>C</b>	Red
<b>F</b>	Green
<b>G</b>	Blue
<b>H</b>	Gray

Material:  
 Polycarbonate

Finish:  
 Glossy

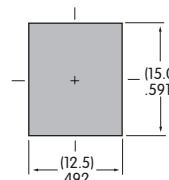
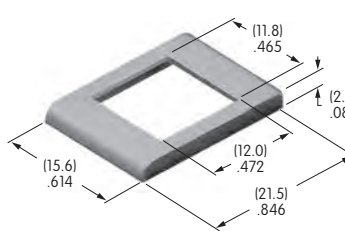

Maximum Panel Thickness  
 .039" ~ .126" (1.0mm ~ 3.2mm)  
 Cutout applies to SP & DP

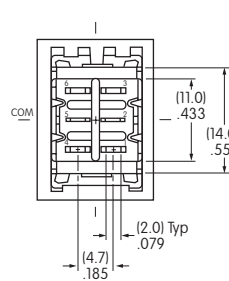
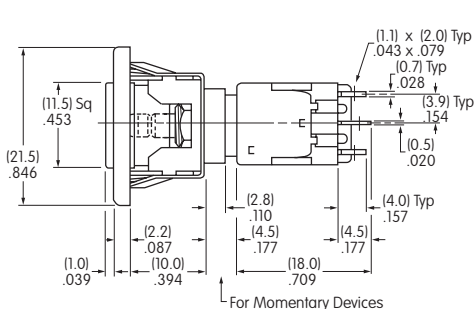
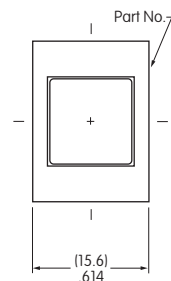

Low Rise

Double Pole

**EB2061-B-J21A**

Toggle  
 Rockers  
 Pushbuttons  
 Illuminated PB  
 Programmable  
 Key locks  
 Rotaries  
 Slides  
 Tactiles  
 Tilt  
 Touch  
 Indicators  
 Accessories  
 Supplement

## CAP EXTENSIONS & BEZEL TYPES

Cap Extension with Bezel

**J22**

Low Rise Momentary

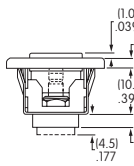

**J32**

Low Rise Alternate

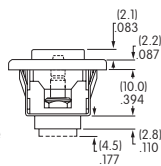

**J42**

High Rise Momentary

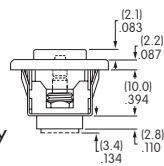

**J52**

High Rise Alternate

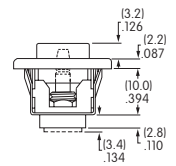

AT208 Bezel with 1 Round LED (AT070 LED)

**A** Black

Material: Polycarbonate  
Finish: Glossy

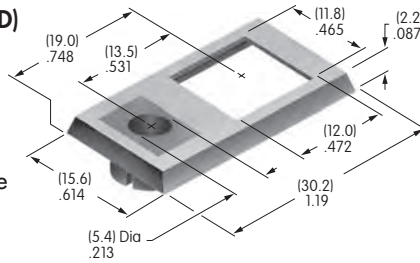

Maximum Panel Thickness  
.039" ~ .126"  
(1.0mm ~ 3.2mm)  
Cutout applies to SP & DP

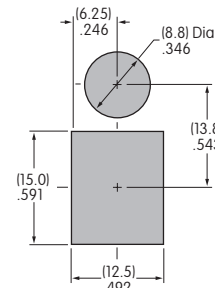

LED colors and specifications on next to last page of this EB section.

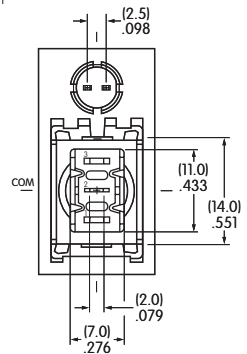
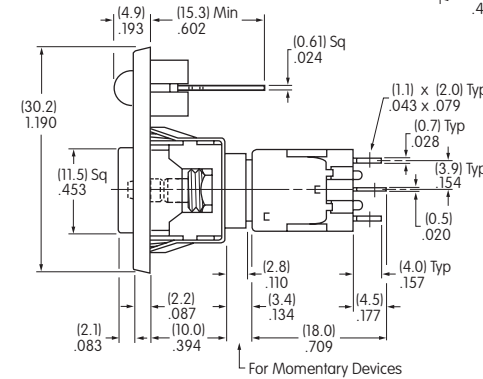
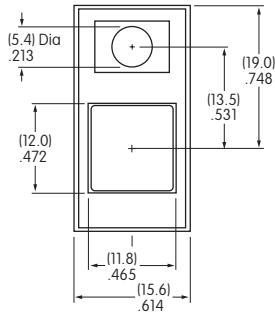

EB2011-B-J42AC

High Rise

Single Pole

Cap Extension with Bezel

**J23**

Low Rise Momentary

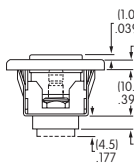

**J33**

Low Rise Alternate

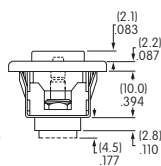

**J43**

High Rise Momentary

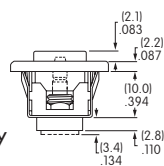

**J53**

High Rise Alternate

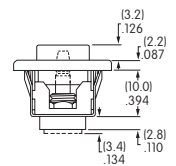

AT212 Bezel with 2 Round LEDs (AT617 LEDs)

**A** Black

Material: Polycarbonate  
Finish: Glossy

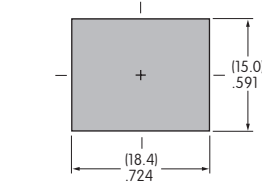
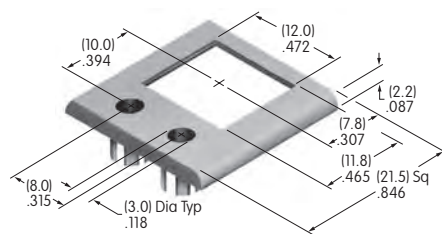

Maximum Panel Thickness  
.039" ~ .126" (1.0mm ~ 3.2mm)  
Cutout applies to SP & DP

LED colors and specifications on next to last page of this EB section.

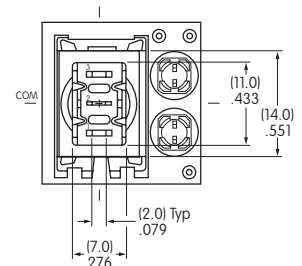
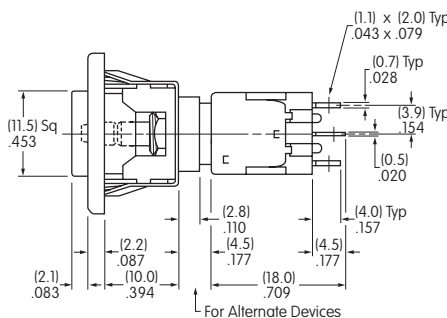
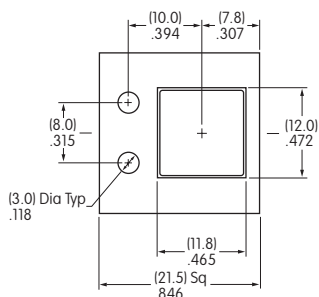

EB2065-B-J33ACF

Low Rise

Single Pole

Toggles  
Rockers  
Pushbuttons  
Illuminated PB  
Programmable  
Keylocks  
Rotaries  
Slides  
Tactiles  
Tilt  
Touch  
Indicators  
Accessories  
Supplement

## CAP EXTENSIONS & BEZEL TYPES

Cap Extension with Bezel

**J24**

Low Rise Momentary

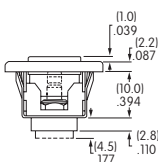

**J34**

Low Rise Alternate

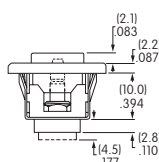

**J44**

High Rise Momentary

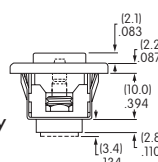

**J54**

High Rise Alternate

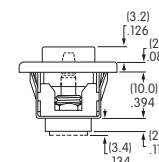

AT213 Bezel with 2 Rectangular LEDs (AT618 LEDs)

**A**

Black

Material: Polycarbonate  
Finish: Glossy

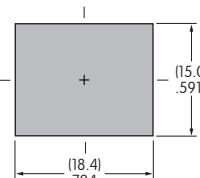
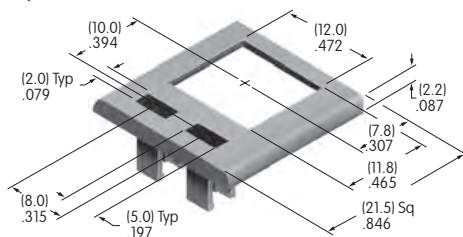

Maximum Panel Thickness  
.039" ~ .126" (1.0mm ~ 3.2mm)  
Cutout applies to SP & DP

LED colors and specifications on next page of this EB section.

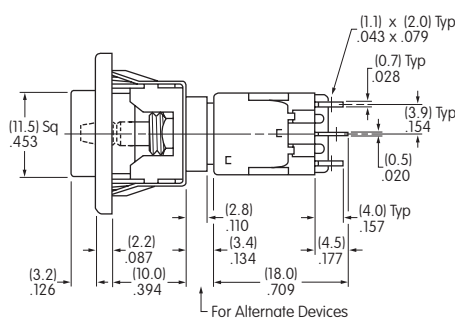
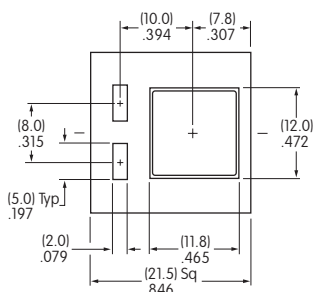

High Rise

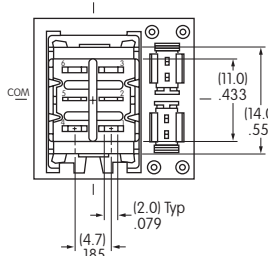

Double Pole



**EB2085-B-J54ACF**

Supplement Accessories Indicators Touch Tilt Tacfiles Slides Rotaries Key locks Programmable Illuminated PB Pushbuttons Rockers Toggles

### LED COLORS & SPECIFICATIONS

#### Bezel Orientation on Switch

**AT070 LED**  
For Bezel AT208  
with 1 LED

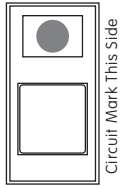

**AT617 LED**  
For Bezel AT212  
with 2 Round LEDs

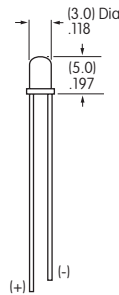
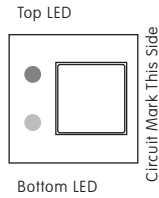

**AT618 LED**  
For Bezel AT213  
with 2 Rectangular LEDs

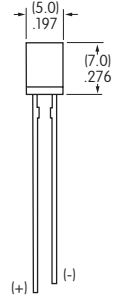
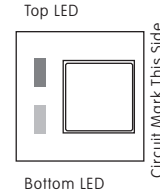

Note: Lead lengths may differ from manufacturing lot to lot. The longer lead is the anode (+).

		AT070		AT617			AT618		
		<b>C</b>	<b>F</b>	<b>C</b>	<b>E</b>	<b>F</b>	<b>C</b>	<b>E</b>	<b>F</b>
	Color	Red	Green	Red	Yellow	Green	Red	Yellow	Green
Maximum Forward Current	$I_{FM}$	25mA	30mA	30mA	30mA	25mA	25mA	30mA	25mA
Typical Forward Current	$I_F$	20mA	20mA	20mA	20mA	20mA	20mA	20mA	20mA
Forward Voltage	$V_F$	2.8V	2.1V	2.0V	2.1V	2.2V	2.25V	2.1V	2.2V
Maximum Reverse Voltage	$V_{RM}$	4V	5V	5V	5V	5V	5V	5V	5V
Current Reduction Rate Above 25°C	$\Delta I_F$	0.33 mA/°C	0.40 mA/°C	0.40 mA/°C	0.40 mA/°C	0.33 mA/°C	0.33 mA/°C	0.40 mA/°C	0.33 mA/°C
Ambient Temperature Range (when used with a bezel)		-10° ~ +70°C		-15° ~ +70°C			-25° ~ +50°C		

The electrical specifications shown are determined at a basic temperature of 25°C.  
LED circuit is independent of switch operation. LED is colored in OFF state.

If the source voltage is greater than the rated voltage of the LED, a ballast resistor must be connected in series with the lamp.  
The ballast resistor calculation and more lamp detail are shown in the Supplement section.

LEGENDS

NKK Switches can provide custom legends for caps. Contact factory for more information.

Suggested Printable Area for Cap

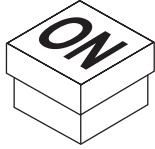

Recommended Print Method:

Screen Print or Pad Print

Epoxy based ink is recommended.

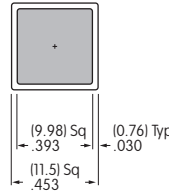

AT465

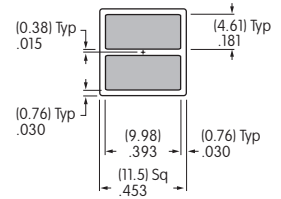

AT465

Shaded areas are printable areas.

Toggles

Rockers

Pushbuttons

Illuminated PB

Programmable

Key locks

Rotaries

Slides

Tactiles

Tilt

Touch

Indicators

Accessories

Supplement

# General Specifications

## FB Series

## SB Series

### Electrical Capacity (Resistive Load)

**Power Level:** 500mA @ 125V AC for silver  
**Logic Level:** 0.4VA max. @ 28V AC/DC max. for gold  
 (Applicable Range 0.1mA ~ 0.1A @ 20mV ~ 28V)  
 Note: Find additional explanation in Supplement section.

3A @ 125V AC or 2A @ 250V AC or  
 2A @ 30V DC for silver  
 0.4VA max. @ 28V AC/DC max. for gold  
 (Applicable Range 0.1mA ~ 0.1A @ 20mV ~ 28V)  
 Note: Find explanation of operating range in Supplement section.

### Other Ratings

**Contact Resistance:** 30 milliohms maximum for silver;  
 30 milliohms maximum for gold  
**Insulation Resistance:** 100 megohms minimum @ 500V DC  
**Dielectric Strength:** 1,000V AC minimum between contacts &  
 between contacts & case for 1 minute minimum  
**Mechanical Life:** 50,000 operations minimum  
**Electrical Life:** 50,000 operations minimum  
**Nominal Operating Force:** 2.16N  
**Travel:** Pretravel .043" (1.1mm)  
 Overtravel .022" (0.57mm)  
 Total Travel .065" (1.67mm)

10 milliohms maximum for silver;  
 20 milliohms maximum for gold  
 200 megohms minimum @ 500V DC  
 1,000V AC minimum between contacts  
 & between contacts & case for 1 minute minimum  
 30,000 operations minimum  
 10,000 operations minimum  
 4.90N  
 Normally Open  
 Total Travel .088" (2.24mm)  
 Normally Closed  
 Total Travel .088" (2.24mm)

### Materials & Finishes

**Plunger:** Polyacetal  
**Bushing:** Brass with nickel plating  
**Case:** Phenolic resin  
**Movable Contactor:** Copper with silver or gold plating  
**Stationary Contacts:** Phosphor bronze with silver or gold plating  
**Terminals:** Phosphor bronze with silver or gold plating

Phenolic resin  
 Brass with nickel plating  
 Phenolic resin  
 Copper with silver or gold plating  
 Copper with silver or gold plating  
 Copper with silver or gold plating

### Environmental & Installation Data

**Operating Temp Range:** -10°C through +70°C (+14°F through +158°F)  
**Soldering Time & Temperature:** Manual Soldering:  
 See Profile A in Supplement section.

-10°C through +70°C (+14°F through +158°F)  
 Manual Soldering:  
 See Profile A in Supplement section.

### Standards & Certifications

**UL:** File No. E44145 - Recognized only when ordered with marking on switch.  
 Add "/U" or "/CUL" before dash in part number to order UL recognized switch.  
 Models rated 0.5A @ 125V AC Single pole;  
 Momentary action circuit with solder lug terminations.

**File No. E44145 - Recognized only when ordered with marking on switch.**  
 Add "/U" or "/CUL" before dash in part number to order UL recognized switch.  
 Models rated 3A @ 125V AC & 2A @ 250V AC.  
 Single pole: Momentary action circuit with solder lug terminations.

**CSA:**

**File No. 023535\_0\_000 - Certified only when ordered with marking on switch.**  
 Add "/C" before dash in part number to order CSA certified switch.  
 SB series rated 3A @ 125V AC & 2A @ 250V AC.  
 Single pole: Momentary action circuit with solder lug terminations.

# Distinctive Characteristics

Optional caps in different colors to vary appearance as needed.

Low operating force for ease of actuation.

Rear panel bushing mount with compact behind panel dimension.

Internal anti-jamming feature to protect the contacts from damage due to excessive force on the plunger.

Self-cleaning contacts make FB models highly reliable.

Low cost device of rugged one-piece bushing and housing construction.

Reliability of construction with an internal guide to maintain contact alignment.

Epoxy sealed terminals.

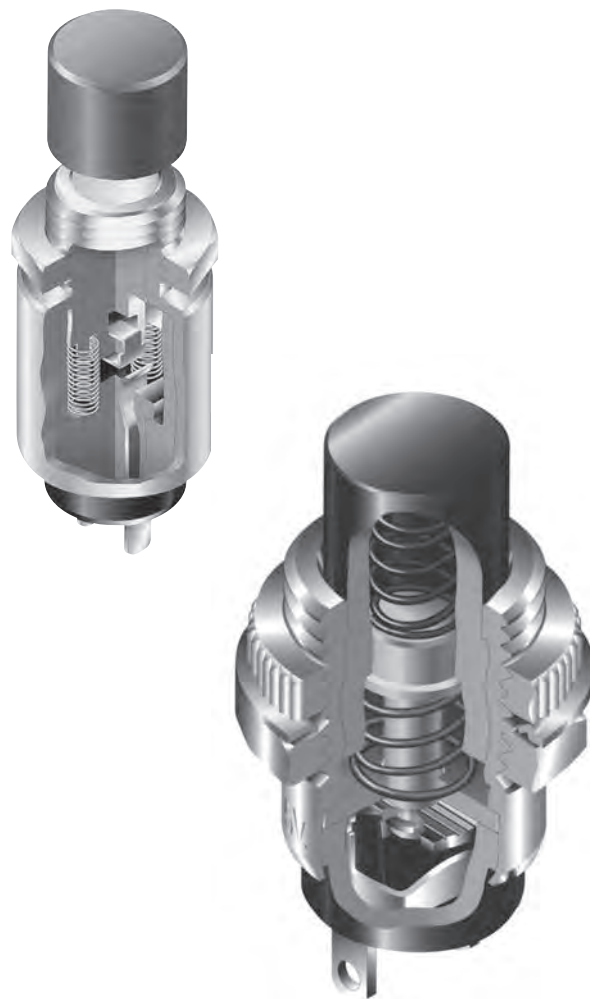

Actual Size FB

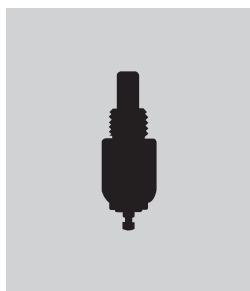

Actual Size SB

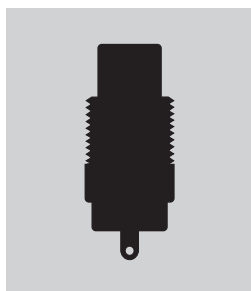

FB Bushing Mount

Page C40



SB Bushing Mount

Page C42

Toggle

Rockers

Pushbuttons

Illuminated PB

Programmable

Keylocks

Rotaries

Slides

Tactiles

Tilt

Touch

Indicators

Accessories

Supplement

## TYPICAL SWITCH ORDERING EXAMPLE

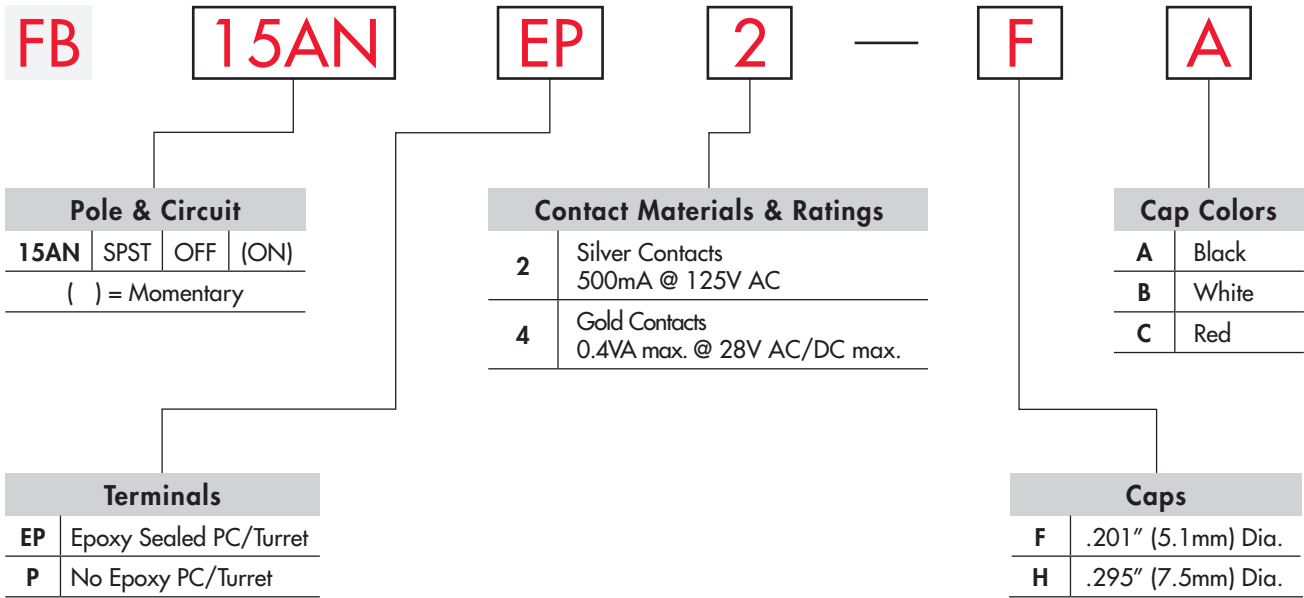

### IMPORTANT:



Switches are supplied without UL & cULus marking unless specified.  
**UL & cULus recognized only when ordered with marking on the switch.**  
 Specific models, ratings, & ordering instructions are noted on the General Specifications page.

### DESCRIPTION FOR TYPICAL ORDERING EXAMPLE

#### FB15ANEP2-FA

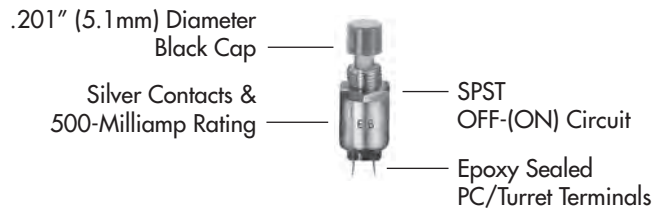

### POLE & CIRCUIT

Pole	Model	Plunger Position ( ) = Momentary		Connected Terminals		Throw & Switch Schematics
		Normal	Down	Normal	Down	
SP	FB15AN	OFF	(ON)	OPEN	1-2	SPST

Note: Terminal numbers are not actually on the switch.

Toggles  
 Rockers  
 Pushbuttons  
 Illuminated PB  
 Programmable  
 Keylocks  
 Rotaries  
 Slides  
 Tactiles  
 Tilt  
 Touch  
 Indicators  
 Accessories  
 Supplement



## TERMINALS

**EP** Epoxy Sealed  
PC/Turret Terminals

**P** No Epoxy  
PC/Turret Terminals

## CONTACT MATERIALS & RATINGS

**2** Silver Contacts

Power Level

500mA @ 125V AC

**4** Gold Contacts

Logic Level

0.4VA maximum @ 28V AC/DC maximum

Complete explanation of operating range in Supplement section.

## TYPICAL SWITCH DIMENSIONS

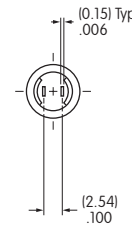
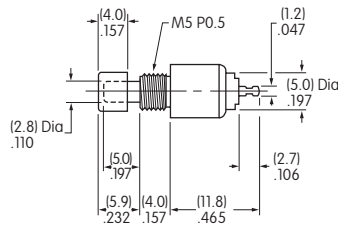
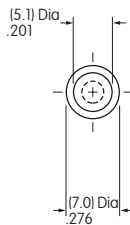

PC/Turret



Plunger is white polyacetal.

**FB15ANEP2-FA**

## SLIP-ON CAPS & COLORS

**F** **AT475**  
.201" (5.1mm) Diameter

Material: Polyamide

Finish: Glossy

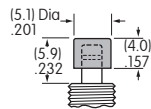

**H** **AT496**  
.295" (7.5mm) Diameter

Material: Polyamide

Finish: Glossy

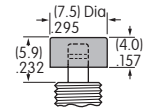

Colors Available:

**A** Black

**B** White

**C** Red

## STANDARD HARDWARE & PANEL CUTOUT

**AT536 Hex Nut**

Material:  
Brass with nickel plating

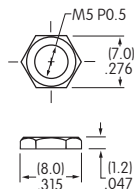

Panel Thickness:

.110" (2.8mm) maximum

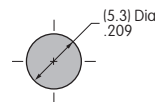

### TYPICAL SWITCH ORDERING EXAMPLE

**SB40**      **11NO**      **M**      **C**      **G**      **M12 P1**

Pole & Circuits			
Normally Open			
<b>11NO</b>	SPST	OFF	(ON)
Normally Closed			
<b>11NC</b>	SPST	ON	(OFF)
( ) = Momentary			

Plunger Colors	
No Code	Black
<b>C</b>	Red

Contact Materials & Ratings	
No Code	Silver Contacts 3A @ 125V AC or 2A @ 250V DC
<b>G</b>	Gold Contacts 0.4VA max. @ 28V AC/DC max.

Bushings	
<b>M</b>	Metric Threaded M12 P1
<b>H</b>	Inch Threaded 15/32-32 NS

Slip-On Cap & Colors	
No Code	Without Cap
<b>2A</b>	Black
<b>2B</b>	White
<b>2C</b>	Red
<b>2E</b>	Yellow
<b>2F</b>	Green
<b>2G</b>	Blue

**IMPORTANT:**  
Switches are supplied without UL, cULus & CSA marking unless specified.  
**UL, cULus & CSA recognized only when ordered with marking on the switch.**  
Specific models, ratings, & ordering instructions are noted on the General Specifications page.

### DESCRIPTION FOR TYPICAL ORDERING EXAMPLE

#### SB4011NOM

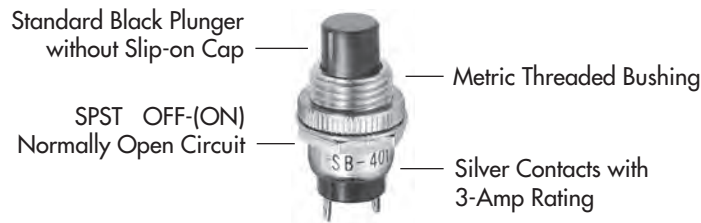

### POLE & CIRCUITS

Pole	Model	Plunger Position ( ) = Momentary		Connected Terminals		Throw & Switch Schematics
		Normal	Down	Normal	Down	
SP	<b>SB4011NO</b>	OFF	(ON)	OPEN	1-2	Note: Terminal numbers are not actually on the switch. SPST NO  NC
	<b>SB4011NC</b>	ON	(OFF)	1-2	OPEN	

## TYPICAL SWITCH DIMENSIONS

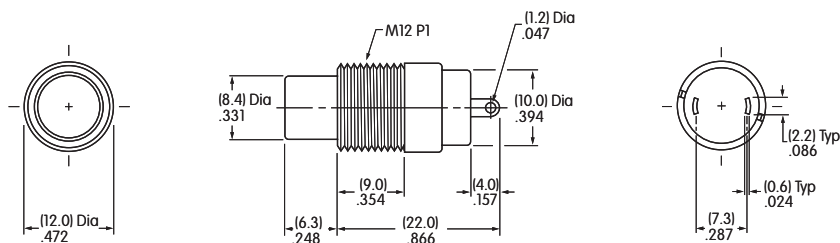

**SB4011NOM**

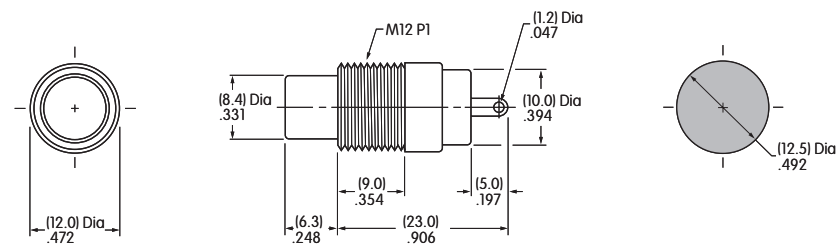

**SB4011NCM**

### Metric Bushing



**SB4011NOM**

Hardware provided:  
 1 AT504 Knurled Face Nut  
 1 AT508 Lockwasher  
 1 AT527M Hex Mounting Nut

Panel Thickness:  
 .157" (4.0mm)

Details in Hardware & Accessories section.

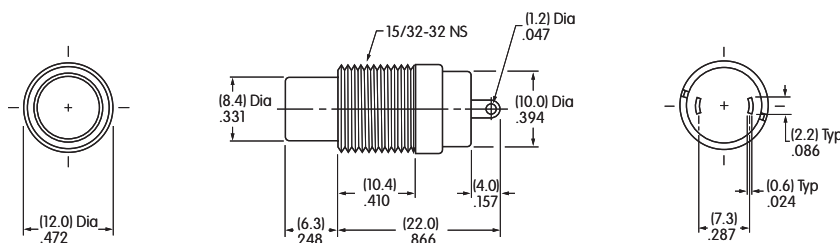

**SB4011NOH**

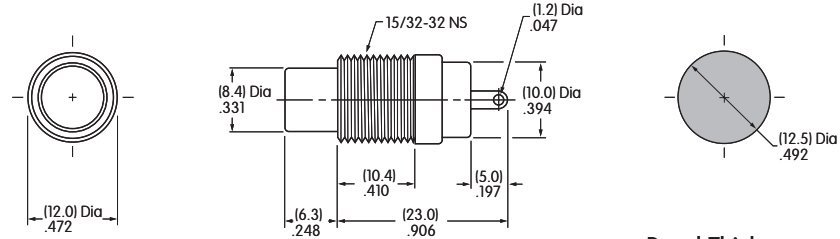

**SB4011NCH**

### Inch Bushing



**SB4011NCH**

Hardware provided:  
 2 AT503H Hex Mounting Nuts  
 1 AT508 Lockwasher

Panel Thickness:  
 .157" (4.0mm)

Details in Hardware & Accessories section.

## SLIP-ON CAP & COLORS

**AT422**  
 .394" (10.0mm) Diameter Cap

Material: Polyethylene  
 Finish: Matte

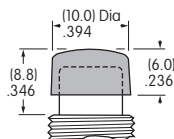

- |                 |                  |                 |
|-----------------|------------------|-----------------|
| <b>2A</b> Black | <b>2C</b> Red    | <b>2F</b> Green |
| <b>2B</b> White | <b>2E</b> Yellow | <b>2G</b> Blue  |

# General Specifications

## Electrical Capacity (Resistive Load)

**Logic Level:** 0.4VA maximum @ 28V AC/DC maximum  
(Applicable Range 0.1mA ~ 0.1A @ 20mV ~ 28V)  
Note: Find additional explanation of operating range in Supplement section.

## Other Ratings

**Contact Resistance:** 80 milliohms maximum  
**Insulation Resistance:** 500 megohms minimum @ 500V DC  
**Dielectric Strength:** 500V AC minimum for 1 minute minimum  
**Mechanical Life:** 50,000 operations minimum  
**Electrical Life:** 50,000 operations minimum  
**Nominal Operating Force:** 1.70N  
**Travel:** Pretravel .035" (0.9mm); Overtravel .008" (0.2mm); Total Travel .043" (1.1mm)

## Materials & Finishes

**Actuator:** Polyacetal  
**Case:** Glass fiber reinforced polyamide  
**Sealing Rings:** Nitrile butadiene rubber  
**Movable Contacts:** Phosphor bronze with gold plating  
**Stationary Contacts:** Phosphor bronze with gold plating  
**Base:** Glass fiber reinforced polyamide  
**Mounting Bracket:** Phosphor bronze with tin plating  
**Terminals:** Phosphor bronze with gold plating

## Environmental Data

**Operating Temp Range:** -30°C through +85°C (-22°F through +185°F)  
**Humidity:** 90 ~ 95% humidity for 96 hours @ 40°C (104°F)  
**Vibration:** 10 ~ 55Hz with peak-to-peak amplitude of 1.5mm traversing the frequency range & returning in 1 minute; 3 right angled directions for 2 hours  
**Shock:** 50G (490m/s<sup>2</sup>) acceleration (tested in 6 right angled directions, with 5 shocks in each direction)

## Installation

**Cap Installation Force:** 39.1N (8.8 lbf) maximum downward force on actuator

## PCB Processing

**Soldering:** Wave Soldering Recommended: See Profile A in Supplement section.  
Manual Soldering: See Profile A in Supplement section.  
**Cleaning:** Automated cleaning. See Cleaning specifications in Supplement section.

## Standards & Certifications

The GB Series pushbuttons have not been tested for UL recognition or CSA certification. These switches are designed for use in a low-voltage, low-current, logic-level circuit. When used as intended in a logic-level circuit, the results do not produce hazardous energy.

# Distinctive Characteristics

Ultra-miniature size allows high density mounting, and extremely light weight of 0.25 gram makes these switches ideal for handheld equipment.

Totally sealed body construction prevents contact contamination and allows time- and money-saving automated soldering and cleaning.

Award-winning STC contact mechanism with benefits unavailable in conventional mechanisms: smoother, positive detent actuation, increased contact stability and unparalleled logic-level reliability. (Additional STC details in Terms & Acronyms; see Supplement section.)

.100" x .100" (2.54mm x 2.54mm) terminal spacing conforms to standard PC board grid-spacing. Round terminals facilitate easier through-hole mounting on PC boards.

Matching indicators available.

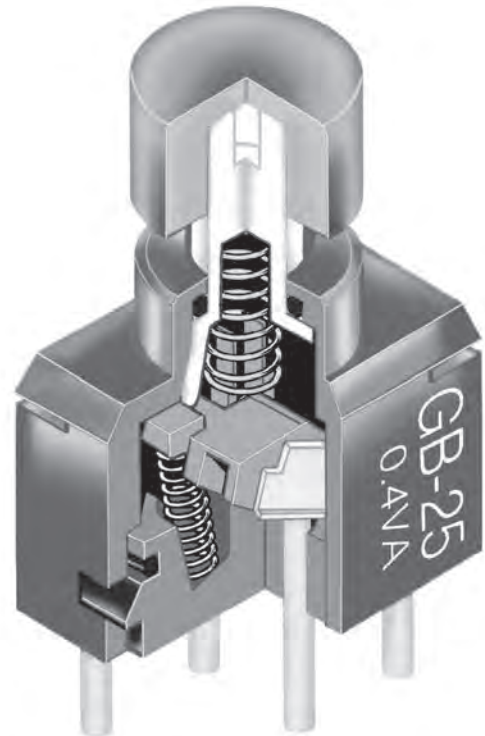

Actual Size

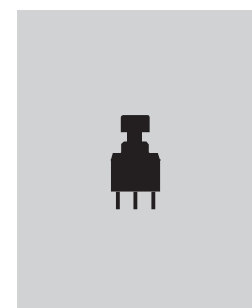

- Toggle
- Rockers
- Pushbuttons**
- Illuminated PB
- Programmable
- Key locks
- Rotaries
- Slides
- Tactiles
- Tilt
- Touch
- Indicators
- Accessories
- Supplement

### TYPICAL SWITCH ORDERING EXAMPLE

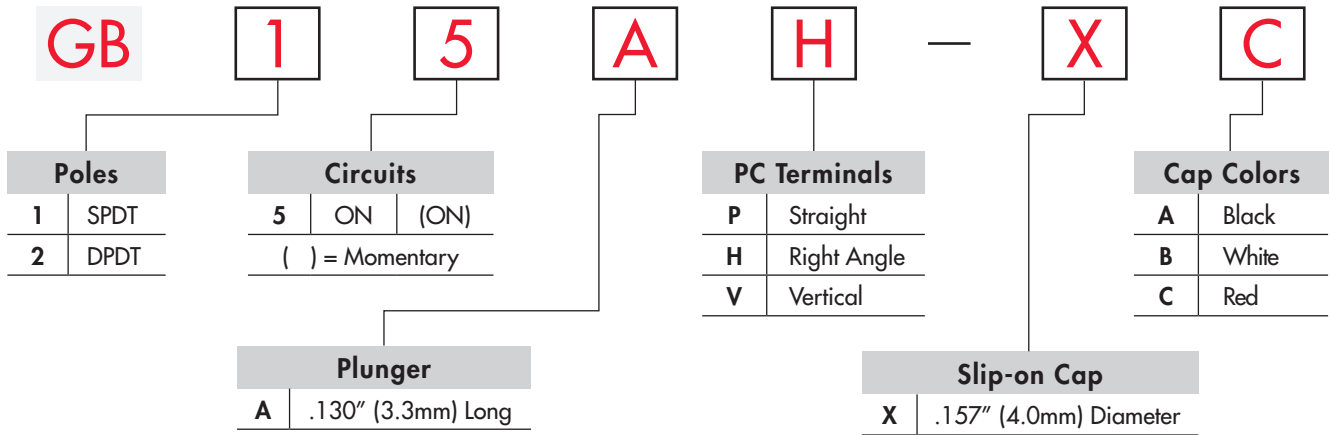

### DESCRIPTION FOR TYPICAL ORDERING EXAMPLE

#### GB15AH-XC

.130" (3.3mm) Long Plunger with  
 .157" (4.0mm) Diameter Red Cap — — SPDT  
 ON-(ON) Circuit — Right Angle PC Terminals

### POLES & CIRCUITS

Pole	Model	Plunger Position ( ) = Momentary		Connected Terminals		Throw & Schematics
		Normal	Down	Normal	Down	
SP	GB15	ON	(ON)	5-6	5-4	SPDT
DP	GB25	ON	(ON)	5-6 2-3	5-4 2-1	DPDT

Note: Terminal numbers are not actually on the switch.

### PLUNGER

**A** .130" (3.3mm) Long Plunger

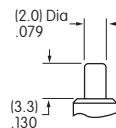

### PC TERMINALS

**P** Straight

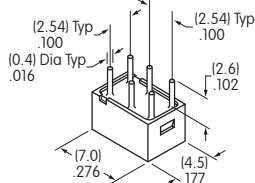

**H** Right Angle

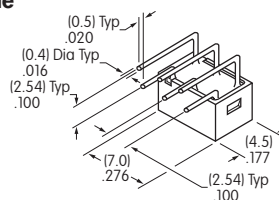

**V** Vertical

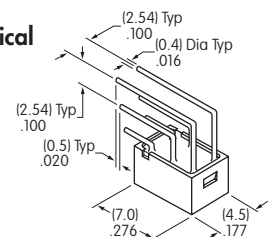

Toggles  
Rocker  
Pushbuttons  
Illuminated PB  
Programmable  
Keylocks  
Rotaries  
Slides  
Tactiles  
Tilt  
Touch  
Indicators  
Accessories  
Supplement

## SLIP-ON CAP & COLORS

**X** **AT4063**  
**.157" (4.0mm) Diameter Slip-on Cap**

Material: Polyamide

Finish: Glossy



Actual Size

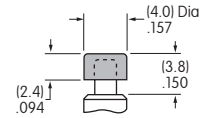

Cap Colors Available:



Black



White



Red

## TYPICAL SWITCH DIMENSIONS

### Single & Double Pole

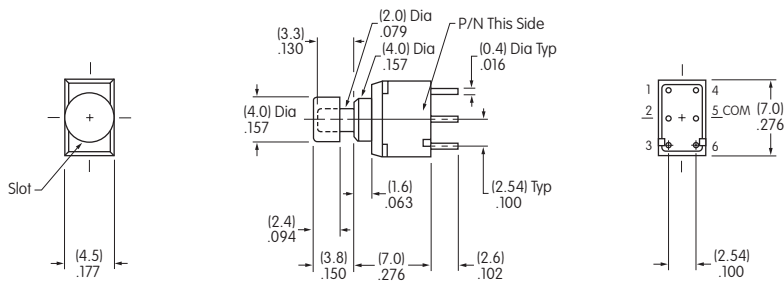

On single pole switches terminals 1 & 3 are support pins.

### Straight PC

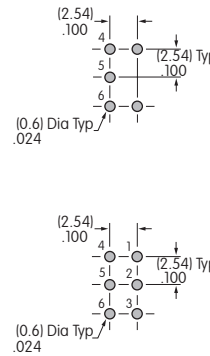

**GB25AP-XC**

### Single & Double Pole

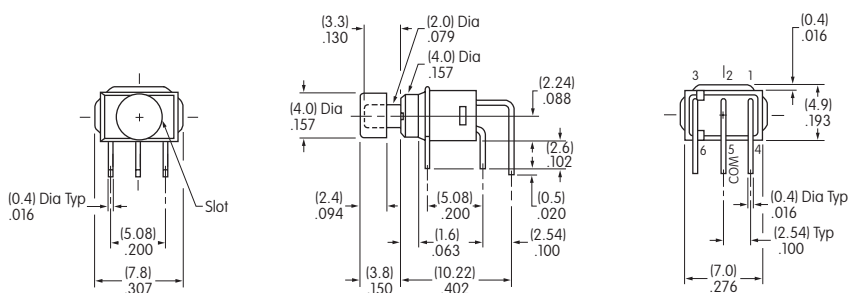

### Right Angle PC

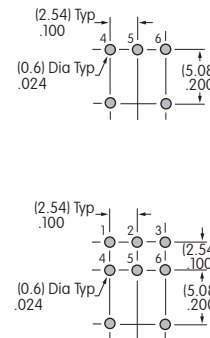

**GB25AH-XC**

### Single & Double Pole

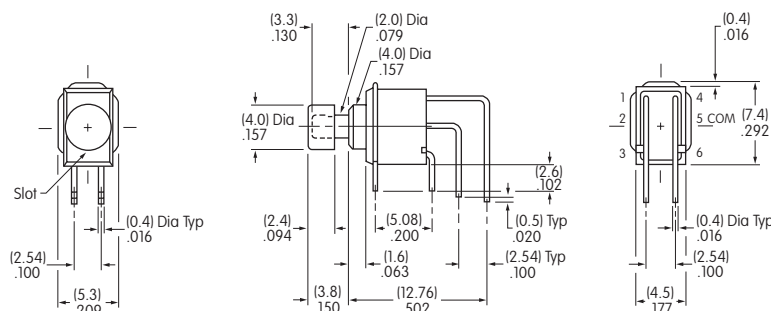

### Vertical PC

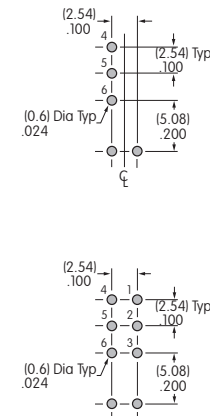

**GB25AV-XC**

# General Specifications

## Electrical Capacity (Resistive Load)

**Logic Level:** 0.4VA maximum @ 28V AC/DC maximum  
(Applicable Range 0.1mA ~ 0.1A @ 20mV ~ 28V)  
Note: Find additional explanation of operating range in Supplement section.

## Other Ratings

**Contact Resistance:** 80 milliohms maximum  
**Insulation Resistance:** 500 megohms minimum @ 500V DC  
**Dielectric Strength:** 500V AC minimum for 1 minute minimum  
**Mechanical Life:** 50,000 operations minimum  
**Electrical Life:** 50,000 operations minimum  
**Nominal Operating Force:** 1.0N  
**Travel:** Pretravel .020" (0.5mm); Overtravel .023 (0.6mm); Total Travel .043" (1.1mm)

## Materials & Finishes

**Actuator:** Glass fiber reinforced polyamide (UL94V-0)  
**Case:** Glass fiber reinforced polyamide (UL94V-0)  
**Movable Contacts:** Phosphor bronze with gold plating  
**Stationary Contacts:** Brass with gold plating  
**Base:** Glass fiber reinforced polyamide (UL94V-0)  
**Mounting Bracket:** Phosphor bronze with tin plating  
**Terminals:** Brass with gold plating

## Environmental Data

**Operating Temperature Range:** -25°C through +70°C (-13°F through +158°F)  
**Humidity:** 90 ~ 95% humidity for 240 hours @ 40°C (104°F)  
**Vibration:** 10 ~ 55Hz with peak-to-peak amplitude of 1.5mm traversing the frequency range & returning in 1 minute; 3 right angled directions for 2 hours  
**Shock:** 50G (490m/s<sup>2</sup>) acceleration (tested in 6 right angled directions, with 5 shocks in each direction)

## PCB Processing

**Soldering:** Wave Soldering Recommended: See Profile A in Supplement section.  
Manual Soldering: See Profile A in Supplement section.  
**Cleaning:** These devices are not process sealed. Hand clean locally using alcohol based solution.

## Standards & Certifications

**Flammability Standards:** UL94V-0 actuator, case, & base  
 The GB2 Series pushbuttons have not been tested for UL recognition or CSA certification. These switches are designed for use in a low-voltage, low-current, logic-level circuit. When used as intended in a logic-level circuit, the results do not produce hazardous energy.



# Distinctive Characteristics

Unique, off-center actuator allows high density setup and easy actuation while avoiding accidental operation in compact environments.

Side-by-side, block mounting can be achieved by use of bracket AT546 on straight PC mounting types.

Off-Momentary On Circuit.

Black, white, and red snap-on caps available.

Extremely thin size allows high density PCB mounting and makes these switches ideal for handheld equipment.

Award-winning STC contact mechanism with benefits unavailable in conventional mechanisms: smoother, positive detent actuation, increased contact stability and unparalleled logic-level reliability. (Additional STC details in Terms & Acronyms; see Supplement section.)

Molded-in, epoxy sealed terminals lock out flux and other contaminants.

.100" x .100" (2.54mm x 2.54mm) terminal spacing conforms to standard PC board grid spacing for straight and angle mounting.

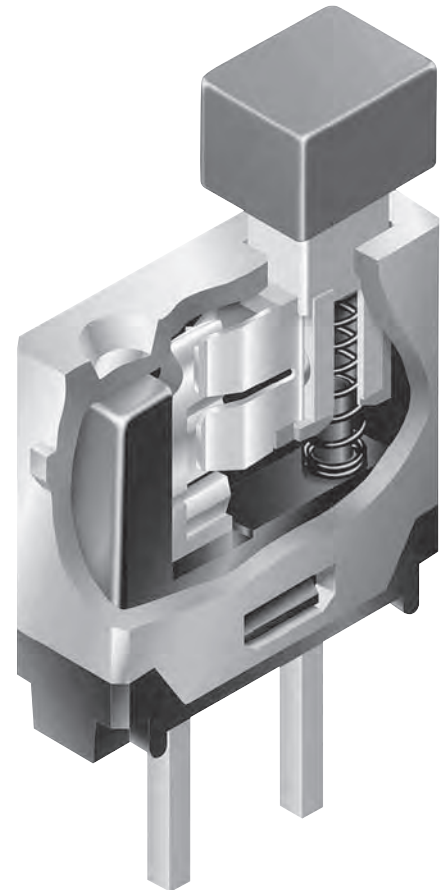

Actual Size

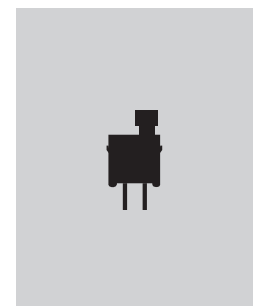

## TYPICAL SWITCH ORDERING EXAMPLE

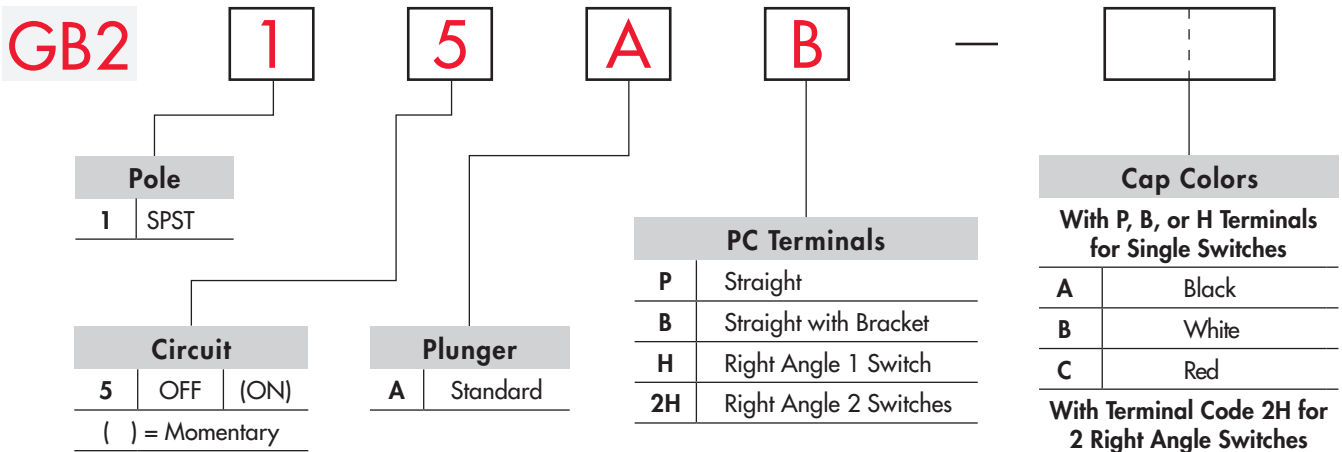

### DESCRIPTION FOR TYPICAL ORDERING EXAMPLE

**GB215AB**



## POLE & CIRCUIT

Pole	Model	Plunger Position ( ) = Momentary		Connected Terminals		Throw & Schematics
		Normal	Down	Normal	Down	
SP	GB215	OFF	(ON)	OPEN	1-2 1-2 3-4	<p>Note: Terminal numbers are not actually on the switch.</p>

## TYPICAL SWITCH DIMENSIONS

### Straight PC



**GB215AP**

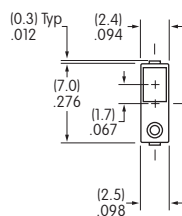

### Single Pole

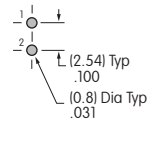
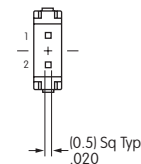
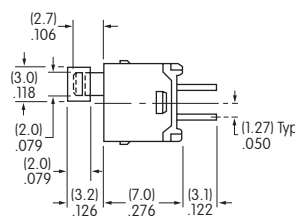

## TYPICAL SWITCH DIMENSIONS

### Single Pole

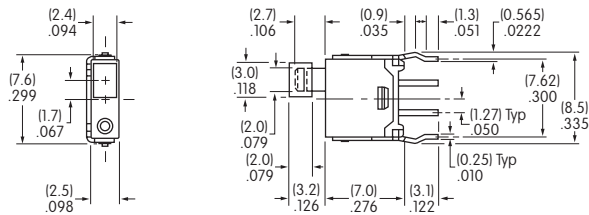

### Straight PC with Bracket

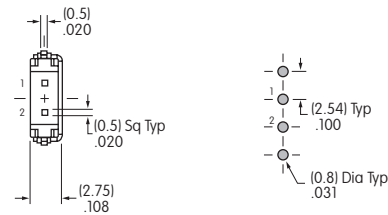

**GB215AB**

### Single Pole with 1 Switch

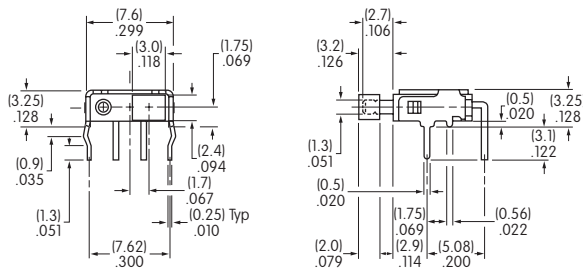

### Right Angle PC

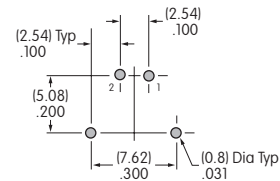

**GB215AH**

### Single Pole with 2 Switches

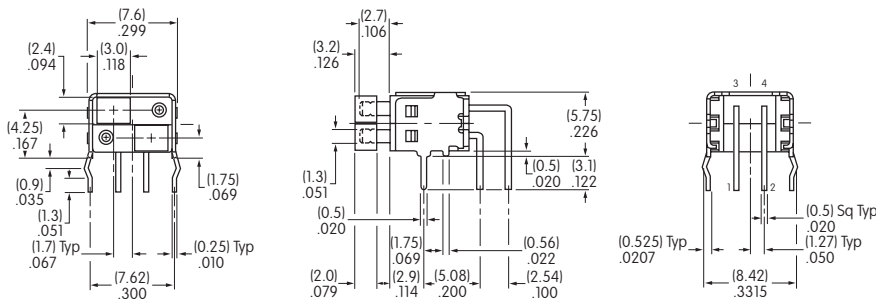

### Right Angle PC

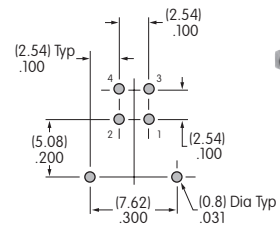

**GB215A2H**

## SNAP-ON CAP & MOUNTING BRACKET

**A** AT4137 Rectangular Snap-on Cap  
Black

**B** AT4137 Rectangular Snap-on Cap  
White

**C** AT4137 Rectangular Snap-on Cap  
Red

Material: PBT  
Finish: Glossy



Actual Size

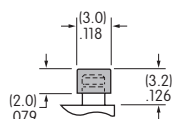

**AT546**  
Mounting Bracket  
for Block Mounting

Material:  
Phosphor Bronze  
with Tin Plating

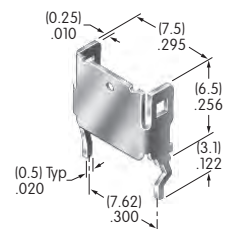

# General Specifications

## Electrical Capacity (Resistive Load)

**Logic Level:** 0.4VA maximum @ 28V AC/DC maximum  
(Applicable Range 0.1mA ~ 0.1A @ 20mV ~ 28V)  
Note: Find additional explanation of operating range in Supplement section.

## Other Ratings

**Contact Resistance:** 80 milliohms maximum  
**Insulation Resistance:** 500 megohms minimum @ 500V DC  
**Dielectric Strength:** 500V AC minimum for 1 minute minimum  
**Mechanical Life:** 50,000 operations minimum  
**Electrical Life:** 50,000 operations minimum  
**Nominal Operating Force:** 2.0N  
**Travel:** Pretravel: .024" (0.6mm); Overtravel: .019" (0.5mm); Total Travel: .043" (1.1mm)

## Materials & Finishes

**Actuator:** Polyphenylene sulfide (UL94V-0)  
**Case:** Polyphenylene sulfide (UL94V-0)  
**Sealing Rings:** Nitrile butadiene rubber  
**Movable Contacts:** Phosphor bronze with gold plating  
**Stationary Contacts:** Phosphor bronze with gold plating  
**Base:** Polyphenylene sulfide (UL94V-0)  
**Terminals:** Phosphor bronze with gold plating

## Environmental Data

**Operating Temperature Range:** -30°C through +85°C (-22°F through +185°F)  
**Humidity:** 90 ~ 95% humidity for 96 hours @ 40°C (104°F)  
**Vibration:** 10 ~ 500Hz with peak-to-peak amplitude of 1.5mm traversing the frequency range & returning in 1 minute; 3 right angled directions for 2 hours  
**Shock:** 50G (490m/s<sup>2</sup>) acceleration (tested in 6 right angled directions, with 5 shocks in each direction)

## Installation

**Mounting:** It is recommended that the body of models for upright mounting without bracket be fastened to a panel or similar support for protection of solder joints from mechanical stress.  
**Coplanarity:** See specifications in Terms & Acronyms in Supplement section.

## Processing

**Soldering:** Reflow Soldering Recommended. See Profile B in Supplement section.  
Manual Soldering: See Profile B in Supplement section.  
**Cleaning:** Automated cleaning. See Cleaning specifications in Supplement section.

## Standards & Certifications

**Flammability Standard:** UL94V-0 actuator, case & base  
The G3B Series pushbuttons have not been tested for UL recognition or CSA certification. These switches are designed for use in a low-voltage, low-current, logic-level circuit. When used as intended in a logic-level circuit, the results do not produce hazardous energy.

# Distinctive Characteristics

Ultra-miniature size allows high density mounting, and extremely light weight of 0.6 gram makes these switches ideal for handheld equipment.

Tape-reel and stick-tube packaging allow rapid automated placement of surface mount devices. Tape-reel packaging meets EIA-481-D Standard.

Heat resistant resin used for housing, base, and plunger allows vapor phase and infrared convection reflow soldering.

Combination of design features achieves total seal and allows automated processing techniques, including flux cleaning procedures: one-piece bushing and housing, rubber seals surrounding actuator and base, epoxy at joint of case and base, and molded-in, epoxy-sealed terminals.

Award-winning STC contact mechanism with benefits unavailable in conventional mechanisms: smoother, positive detent actuation, increased contact stability and unparalleled logic-level reliability. (Additional STC details in Terms & Acronyms; see Supplement section.)

Gull-wing terminals provide mechanical stability during soldering and simplified solder joint inspection.

Coplanarity: all considered surfaces must lie between two parallel planes that area maximum distance apart of .0059" (0.15mm). (Additional coplanarity details in Terms and Acronyms in the Supplement section.)

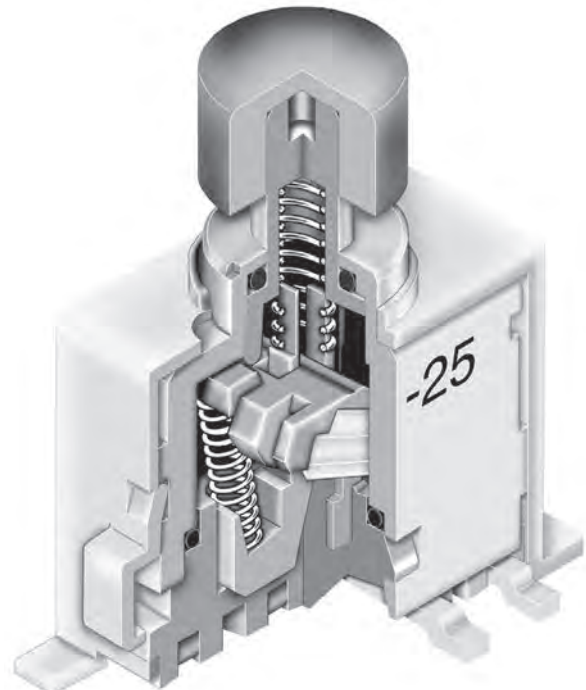

Actual Size



Toggles

Rockers

 Pushbuttons

Illuminated PB

Programmable

Key locks

Rotaries

Slides

Tactiles

Tilt

Touch

Indicators

Accessories

Supplement

### TYPICAL SWITCH ORDERING EXAMPLE

**G3B** **1** **5** **A** **B** — [ ] — [ ] — [ ]

Poles	
1	SPDT
2	DPDT

Plunger	
A	.130" (3.3mm) Long

Terminals	
P	Gull Wing for Upright Mount
B	Gull Wing for Upright with Bracket
H	Gull Wing for Right Angle

Colors	
A	Black
B	White
C	Red

Circuits		
5	ON	(ON)
( ) = Momentary		

Packaging	
No Code	Partitioned Tray for Upright & Right Angle - Any Quantity
R	Tape-Reel for Right Angle Only 500 Pieces/Reel
S	Stick-Tube for Upright Mount 50 Pieces/Stick

Optional Caps	
X	Slip-on Cap .157" (4.0mm) Diameter (For installation after processing only)
Y	Process Compatible Cap .157" (4.0mm) Diameter (Combines with R or S packaging only)

Packaging details at end of G3B Series

### DESCRIPTION FOR TYPICAL ORDERING EXAMPLE

#### G3B15AB



### POLES & CIRCUITS

Pole	Model	Plunger Position ( ) = Momentary		Connected Terminals		Throw & Schematics
		Normal	Down	Normal	Down	
SP	G3B15	ON 	(ON) 	5-6 	5-4 	Note: Terminal numbers are not actually on the switch. SPDT 
DP	G3B25	ON	(ON)	5-6 2-3	5-4 2-1	DPDT 

## PLUNGER & OPTIONAL CAPS

**A** .130" (3.3mm) Long Plunger

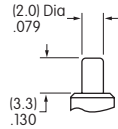

**X** AT4063 Slip-on Cap  
.157" (4.0mm) Diameter

Available with bulk packaging only. Cap must be installed after processing.

Material: Polyamide

Finish: Glossy



Actual Size

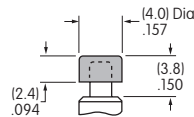

**Y** Process Compatible Cap  
.157" (4.0mm) Diameter

Factory assembled. Available with tape-reel or stick-tube packaging only.

**Caution:** Pulling force specification for this cap is not warranted after reflow processing.

Material: Polyamide

Finish: Glossy

Cap Colors Available:

**A** Black

**B** White

**C** Red

## TYPICAL SWITCH DIMENSIONS

### Single & Double Pole

### Upright Mounting

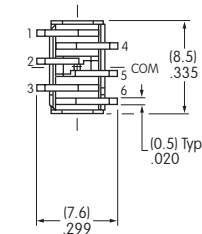
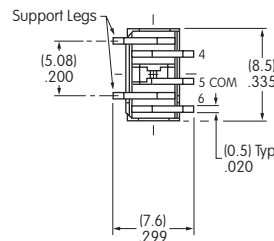
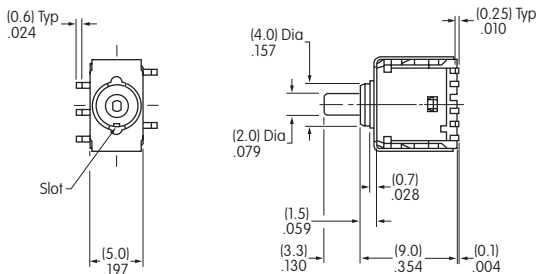

G3B25AP

### Single & Double Pole

### Upright Mounting with Bracket

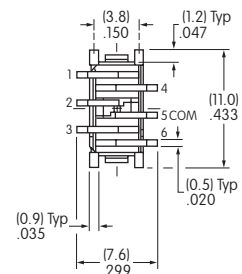
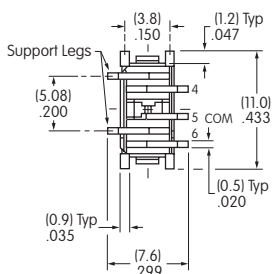
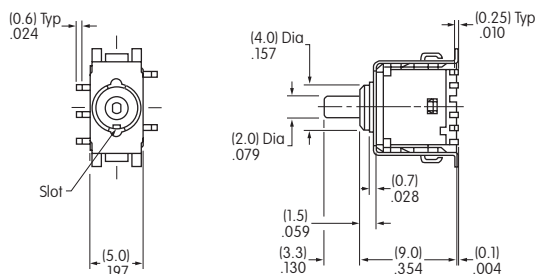

G3B15AB

### Right Angle Mounting

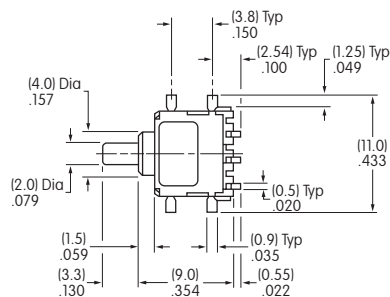

### Single Pole

### Double Pole

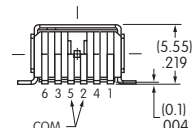
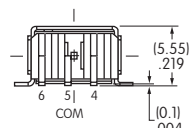
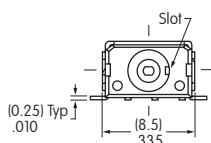

G3B15AH

### Pad Layouts for Surface Mount Terminals

#### Upright Mounting

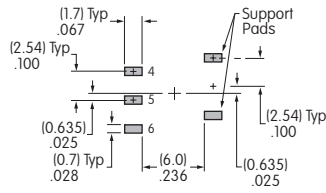

Single Pole Double Throw

#### Upright Mounting with Bracket

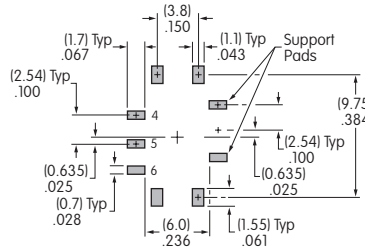

#### Right Angle Mounting

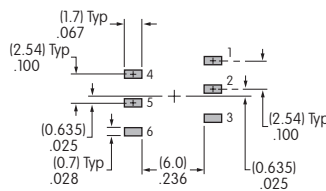
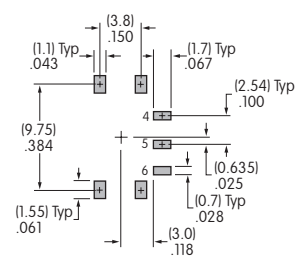

Double Pole Double Throw

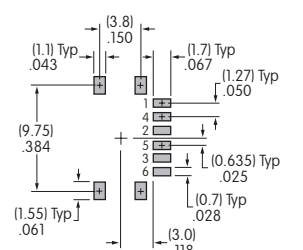
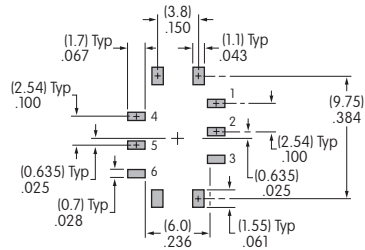

## PACKAGING

**No Code**

### Partitioned Tray for Upright & Right Angle

Any quantity

If the G3 upright models are ordered in less than 50-piece increments or the right angle models in less than 500-piece increments, the switches are packaged in a partitioned tray. No code is required.



**R**

### Tape-Reel for Right Angle

500 pieces per reel

Switches must be ordered in 500-piece increments when tape-reel packaging is selected.

This packaging meets EIA-481-D Standard for "16mm and 24mm Embossed Carrier Taping of Surface Mount Components for Automatic Handling."

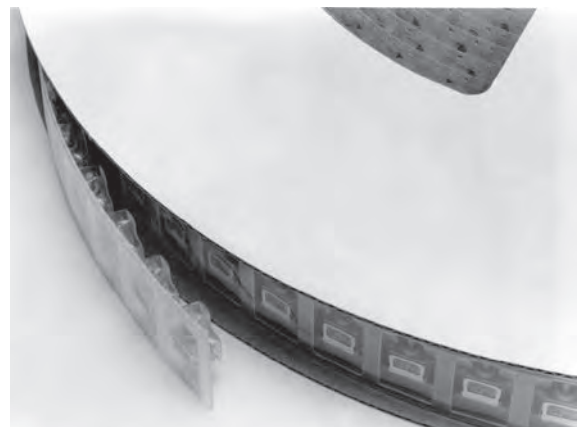



PACKAGING (CONTINUED)

**S** Stick-Tube for Upright Mount

50 pieces per stick

Switches must be ordered in 50-piece increments when stick-tube packaging is selected.



Tape-Reel Packaging for Right Angle Mount

Each tape-reel of 550 pockets contains 500 switches.

Minimum Leader Length: 7.87" (200mm) Minimum Trailer Length: 1.97" (50mm)

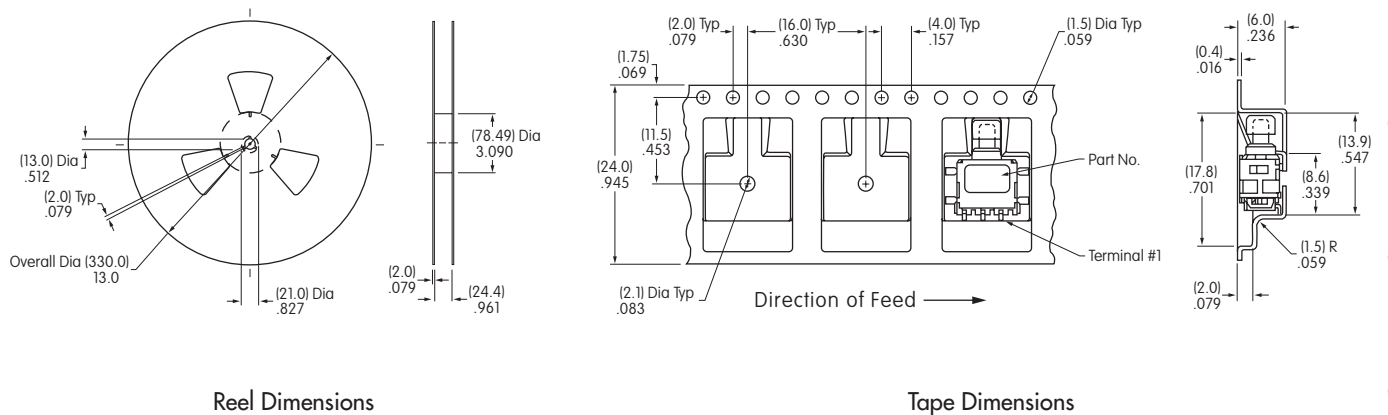

Stick-Tube Packaging for Upright Mount

Each stick-tube contains 50 switches.

L = Length

G3B Upright (code P)  
18.31" (465mm)

G3B Upright with Bracket (code B)  
21.26" (540mm)

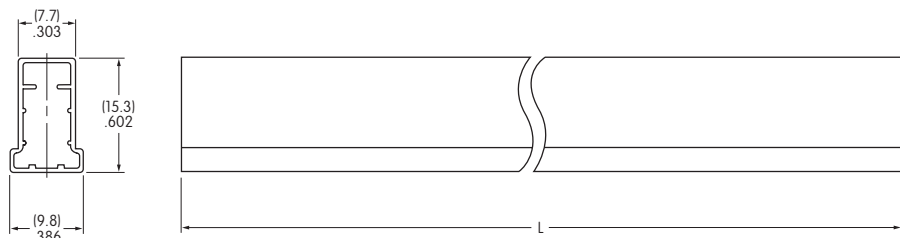

Stick-Tube Dimensions

# General Specifications

## Electrical Capacity (Resistive Load)

**Power Level:** 10A @ 125/250V AC for JPM models & 16A @ 125/250V AC for JPL models

## Other Ratings

**Contact Resistance:** 20 milliohms maximum

**Insulation Resistance:** 1,000 megohms minimum @ 500V DC

**Dielectric Strength:** 2,000V AC minimum between contacts for 1 minute minimum;  
4,000V AC minimum between contacts & case for 1 minute minimum

**Mechanical Life:** 25,000 operations minimum

**Electrical Life:** 25,000 operations minimum

**Nominal Operating Force:** JPM Single Pole 3.53N & Double Pole 6.47N

JPL Single Pole 4.51N & Double Pole 9.02 N

**Contact Timing:** Nonshorting (break before make)

**Latchdown:** Normal position - flush with barrier; latchdown position - .079" (2.0mm) below normal

**Travel:** Pretravel .059" (1.5mm); Overtravel .071" (1.8mm); Total Travel .130" (3.3mm)

## Materials & Finishes

**Housing/Frame & Barrier:** Polyamide (UL94V-0)

**Interior Seal:** Polyphenylene sulfide (UL94V-0)

**Case/Base:** Melamine (UL94V-0)

**Movable Contacts:** Silver alloy

**Stationary Contacts:** Silver alloy plus copper

**Terminals:** Brass with silver plating

## Environmental Data

**Operating Temp Range:** -10°C through +70°C (+14°F through +158°F)

**Humidity:** 90 ~ 95% humidity for 96 hours @ 40°C (104°F)

**Vibration:** 10 ~ 55Hz with peak-to-peak amplitude of 1.5mm traversing the frequency range & returning in 1 minute; 3 right angled directions for 2 hours

**Shock:** 50G (490m/s<sup>2</sup>) acceleration (tested in 6 right angled directions, with 5 shocks in each direction)

**Process Seal:** Dust resistant inner seal

## Installation

**Soldering Time & Temp:** Manual Soldering: See Profile A in Supplement section.

## Standards & Certifications

**Flammability Standards:** UL94V-0 for housing/frame, barrier, interior seal, & case/base

**TV Ratings for UL:** JPM (TV-5) Overload Test @ 125V AC for 50 operations:

Steady State Current (rms) 7.5A; Minimum Inrush Current (peak) 111A

JPM (TV-5) Endurance Test @ 125V AC for 25,000 operations:

Steady State Current (rms) 5A; Minimum Inrush Current (peak) 78A

JPL (TV-8) Overload Test @ 125V AC for 50 operations:

Steady State Current (rms) 12A; Minimum Inrush Current (peak) 163A

JPL (TV-8) Endurance Test @ 125V AC for 25,000 operations:

Steady State Current (rms) 8A; Minimum Inrush Current (peak) 117A

**UL:** **File No. E44145 - Recognized only when ordered with marking on switch.**

Add "/U" or "/CUL" before dash in part number to order UL recognized switch.

All JPM models certified at 10A @ 125V AC, TV5 & JPL models at 16A @ 125V AC, TV8.

**VDE:** **License No. 40028887 - Approved only when ordered with marking on switch.**

Add "/V" before dash in part number to order VDE approved switch.

All JPM models approved at steady state 5A, inrush 80A, resistive 10A, & motor load 6A all at 250V AC.

**License No. 40039784**

All JPL models approved at steady state 8A, inrush 128A, resistive 16A, & motor load 8A all at 250V AC.

# Distinctive Characteristics

Industry's first molded pushbutton with TV rating. Designed to handle large inrush current. JPM models certified for TV-5 rating and JPL models for TV-8 rating.

Prominent external insulating barriers increase insulation resistance and dielectric strength.

Constructed for dust resistance with interior seal of polyphenylene sulfide (PPS) between actuator and contact area.

Specially designed to break light contact welds.

Snap-action contact mechanism.

Terminals are molded in and epoxy sealed to lock out flux, dust, and other contaminants.

Outer case of heat resistant resin meets UL's 94V-0 flammability standard.

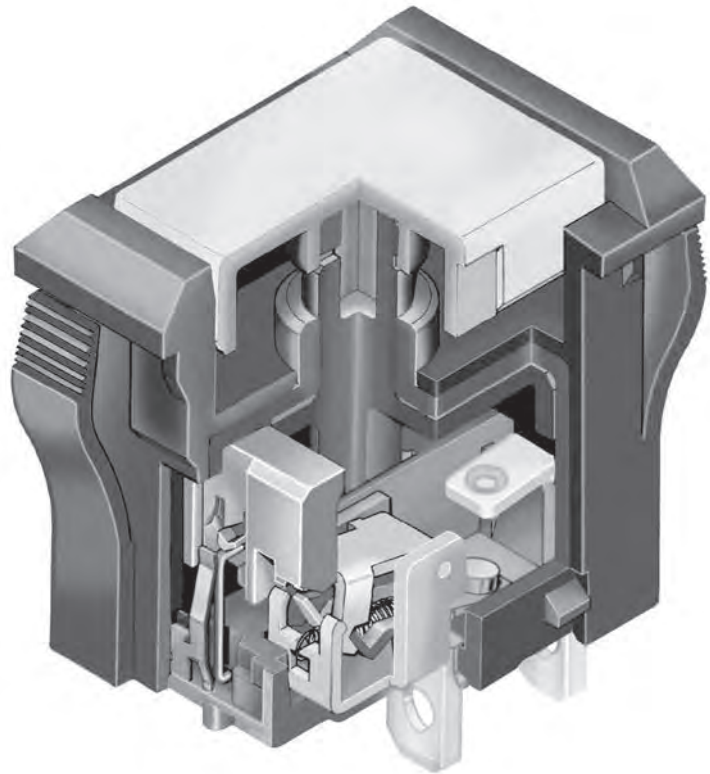

Actual Size JPM

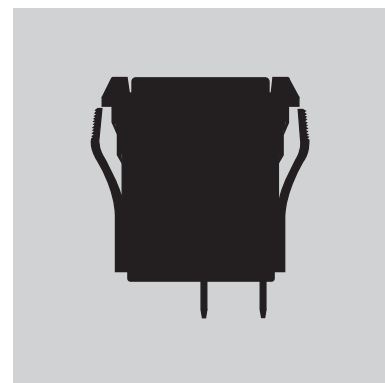

- Toggle
- Rockers
- Pushbuttons**
- Illuminated PB
- Programmable
- Key locks
- Rotaries
- Slides
- Tactiles
- Tilt
- Touch
- Indicators
- Accessories
- Supplement

### TYPICAL SWITCH ORDERING EXAMPLE

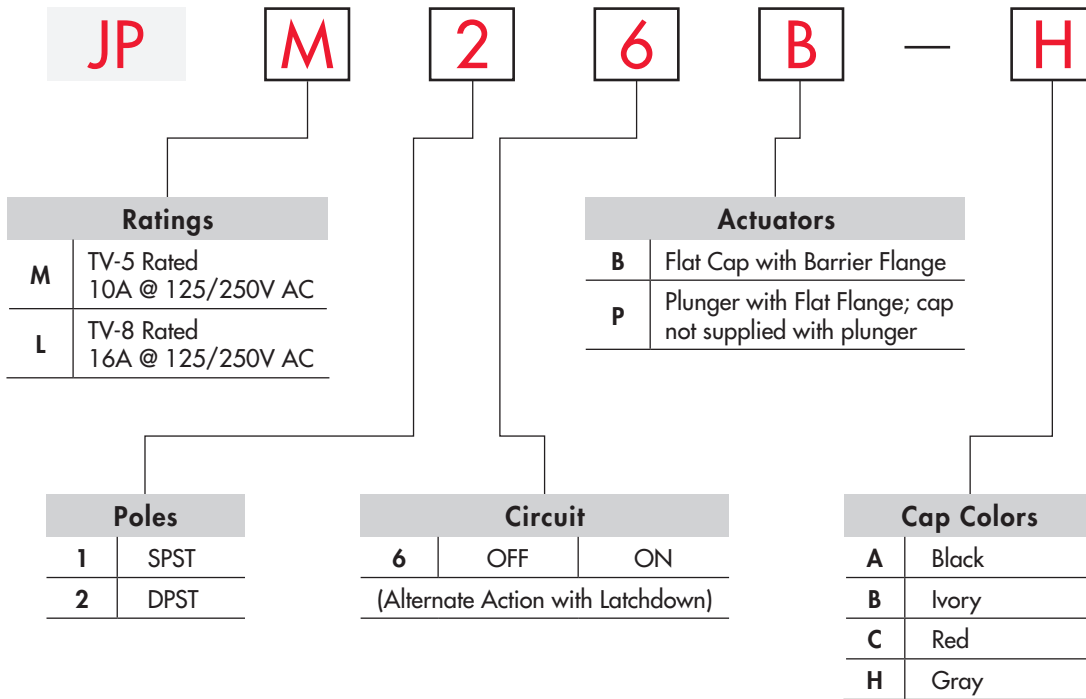

#### IMPORTANT:



Switches are supplied without UL & VDE markings unless specified.  
**UL recognized only when ordered with marking on the switch.**  
**VDE approved only when ordered with marking on the switch.**  
 Specific models, ratings, & ordering instructions are noted on the General Specifications page.

#### DESCRIPTION FOR TYPICAL ORDERING EXAMPLE

#### JPM26B-H

Gray Flat Cap with Barrier Flange



TV-5 Rated  
10A @ 125/250V AC

DPST  
OFF-ON Circuit

## RATINGS



TV-5 Rated

Power Level

10A @ 125/250V AC



TV-8 Rated

Power Level

16A @ 125/250V AC

Note: See General Specifications page to find complete explanation of TV ratings.

## POLES & CIRCUIT

Pole	Model	Plunger Position		Connected Terminals		Throw & Schematics
		Normal	Down	Normal	Down	
SP	JPM16 JPL16	OFF 	ON 	OPEN 	1-1a 	Note: Terminal numbers are actually on the switch. SPST
DP	JPM26 JPL26	OFF 	ON 	OPEN 	1-1a 2-2a 	DPST

## ACTUATORS



**Flat Cap with Barrier Flange**

The barrier is an integral part of the switch. This housing is black, molded polyamide matte finish material.

Cap details below.



**Plunger with Flat Flange**

The flange is an integral part of the switch. This housing is black, molded polyamide matte finish material.

No cap supplied.



## CAP COLORS

**AT3021 Flat Cap for Actuator Type B with Barrier Flange**

Cap Material:  
Polyphenylene Oxide

Finish: Matte

Cap Colors Available:

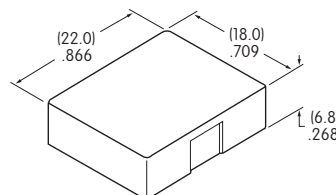

The cap is flush with the barrier in normal position and .079" (2.0mm) below that in latchdown position.

The latchdown feature on this alternate action device provides visible, audible, and tactile feedback. This design gives smooth, responsive operation.



Black



Ivory



Red



Gray

### PANEL CUTOUT & TERMINALS

Panel Thickness Range  
applies to both  
JPM & JPL models.  
  
.039" ~ .157"  
(1.0mm ~ 4.0mm)

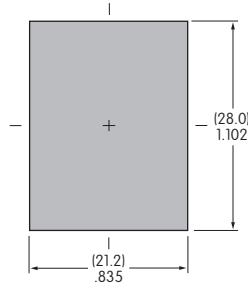

**JPM & JPL Solder Lug/  
.187" (4.75mm) Quick Connect Terminals**

This switch assembly,  
when used with connectors,  
is not VDE approved.

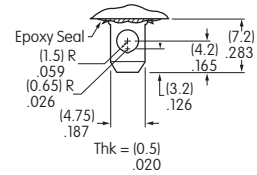

### TYPICAL SWITCH DIMENSIONS

#### Flat Cap with Barrier Flange

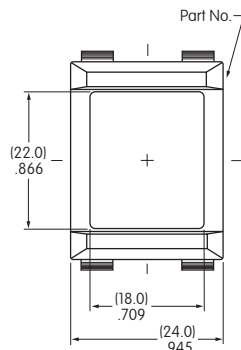

#### JPM & JPL Single & Double Pole

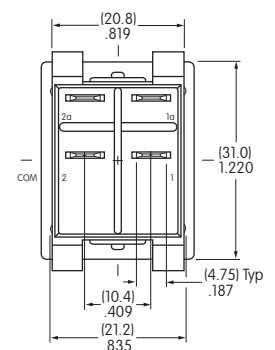
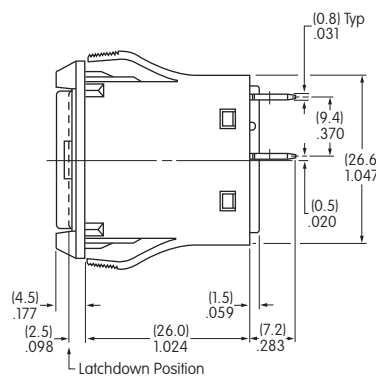

**JPM26B-H**

Single pole model does not have terminals 2 & 2a.

#### Plunger with Flat Flange

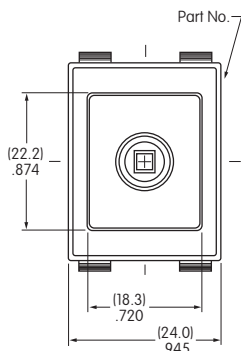

#### JPM & JPL Single & Double Pole

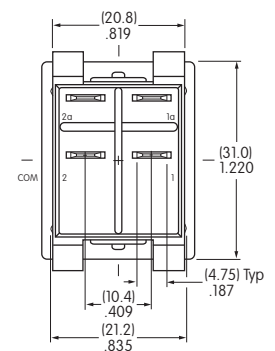
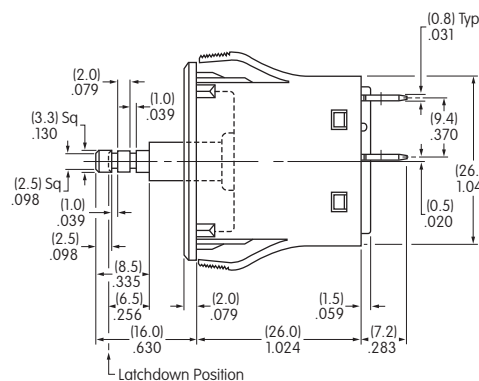

**JPL16P**

Single pole model does not have terminals 2 & 2a.



# General Specifications

## Electrical Capacity (Resistive Load)

<b>Power Level (silver):</b>	1A @ 125V AC or 1A @ 30V DC
<b>Logic Level (gold):</b>	0.4VA maximum @ 28V AC/DC maximum (Applicable Range 0.1mA ~ 0.1A @ 20mV ~ 28V)
<b>Logic/Power Level: (gold over silver)</b>	Combines silver & gold ratings

Note: Find additional explanation of dual rating & operating range in Supplement section.

## Other Ratings

<b>Contact Resistance:</b>	20 milliohms maximum for silver; 30 milliohms maximum for gold
<b>Insulation Resistance:</b>	1,000 megohms minimum @ 500V DC
<b>Dielectric Strength:</b>	1,000V AC minimum between contacts for 1 minute minimum; 1,500V AC minimum between contacts & case for 1 minute minimum
<b>Mechanical Life:</b>	200,000 operations minimum
<b>Electrical Life:</b>	25,000 operations minimum for silver; 100,000 operations minimum for gold
<b>Nominal Operating Force:</b>	Single pole 2.94N & double pole 4.90N
<b>Contact Timing:</b>	Nonshorting (break-before-make)
<b>Travel:</b>	Pretravel .023" (0.6mm); Overtravel .016" (0.4mm); Total Travel .039" (1.0mm)

## Materials & Finishes

<b>Plunger:</b>	Brass with nickel plating
<b>Support Bracket:</b>	Brass with tin plating
<b>Bushing/Housing:</b>	Glass fiber reinforced polyamide (UL94V-0)
<b>Sealing Ring:</b>	Nitrile butadiene rubber
<b>Base:</b>	Glass fiber reinforced polyamide (UL94V-0)
<b>Movable Contacts:</b>	Silver alloy with silver plating (code W); copper with gold plating (code G); or silver alloy with gold plating (code A)
<b>Stationary Contacts:</b>	Silver alloy with silver plating (code W); copper with gold plating (code G); or silver alloy with gold plating (code A)
<b>Terminals:</b>	Brass with silver or gold plating

## Environmental Data

<b>Operating Temp Range:</b>	-30°C through +85°C (-22°F through +185°F)
<b>Humidity:</b>	90 ~ 95% humidity for 96 hours @ 40°C (104°F)
<b>Vibration:</b>	10 ~ 55Hz with peak-to-peak amplitude of 1.5mm traversing the frequency range & returning in 1 minute; 3 right angled directions for 2 hours
<b>Shock:</b>	50G (490m/s <sup>2</sup> ) acceleration (tested in 6 right angled directions, with 5 shocks in each direction)

## Installation

<b>Cap Installation Force:</b>	49.0N (11.0 lbf) for plunger A & 79.4N (17.9 lbf) for plunger B
--------------------------------	---

## PCB Processing

<b>Soldering:</b>	Wave Soldering Recommended: See Profile B in Supplement section. Manual Soldering: See Profile B in Supplement section.
<b>Cleaning:</b>	Automated cleaning. See Cleaning specifications in Supplement section.

## Standards & Certifications

<b>Flammability Standards:</b>	UL94V-0 rated bushing/housing & base
<b>UL:</b>	<b>File No. E44145 - Recognized only when ordered with marking on switch.</b> Add "/U" or "/CUL" before dash in part number to order UL recognized switch. All models recognized at 1A @ 125V AC, 1A @ 30V DC, or 0.4A @ 28V DC.
<b>CSA:</b>	<b>File No. 023535_0_000 - Certified only when ordered with marking on switch.</b> Add "/C" before dash in part number to order CSA certified switch. All models certified at 1A @ 125V AC, 1A @ 30V DC, or 0.4A @ 28V DC.



# Distinctive Characteristics

Snap-acting contact mechanism gives short travel, sensitive actuation, light touch, smooth feel, audible feedback, and a longer electrical life.

Single unit construction of the bushing and top of the housing gives protection from cleaning fluids or other liquids.

O-ring surrounding actuator at top of bushing interior prevents liquids from reaching switch mechanism.

Ultrasonic welding of upper and lower housing seals out contaminants and allows automated soldering and cleaning.

Terminals are epoxy sealed to prevent entry of flux, solvents, and other contaminants.

Bracketed models have crimped bracket legs to ensure secure PC mounting and prevent dislodging during automated soldering.

Logic level and power capabilities are available to suit varying applications.

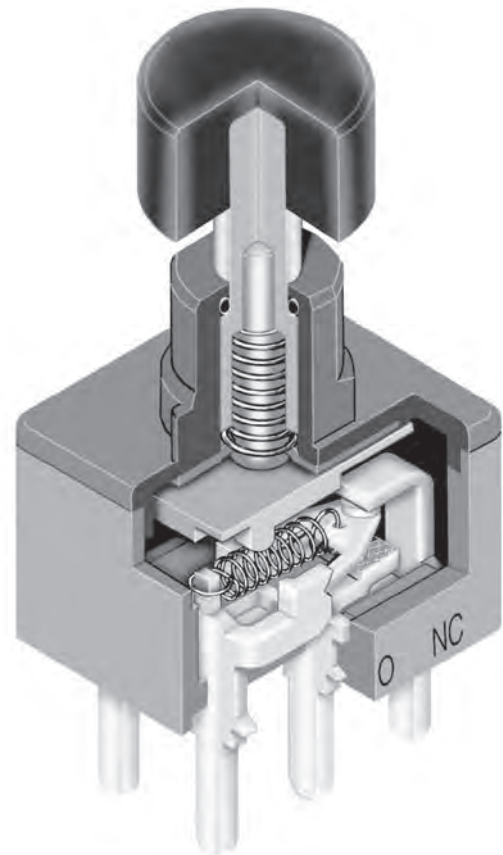

Actual Size

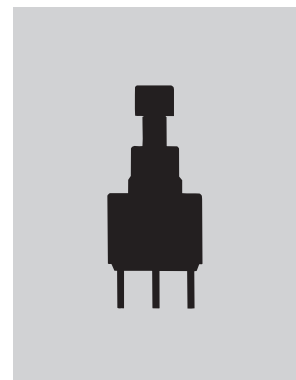

- Toggle
- Rockers
- Pushbuttons**
- Illuminated PB
- Programmable
- Key locks
- Rotaries
- Slides
- Tactiles
- Tilt
- Touch
- Indicators
- Accessories
- Supplement

### TYPICAL SWITCH ORDERING EXAMPLE

**M2B** **15** **A** **A5** **G** **30** — **F** **C**

Poles & Circuits			
15	SPDT	ON	(ON)
25	DPDT	ON	(ON)
( ) = Momentary			

Plungers	
<b>A</b>	.282" (7.16mm) Long for cap codes F & H
<b>B</b>	.307" (7.8mm) Long for cap codes B & C

Bushing	
<b>A5</b>	.250" (6.35mm) Double Flatted

Contact Materials & Ratings	
<b>W</b>	Silver; Rated 1A @ 125V AC & 1A @ 30V DC
<b>G</b>	Gold; Rated 0.4VA maximum @ 28V AC/DC maximum
<b>A</b>	Gold over Silver; Rated 1A @ 125V AC & 0.4VA max @ 28V AC/DC max

PC Terminals	
<b>03</b>	Straight
<b>13</b>	Straight with .460" (11.7mm) Bracket
<b>30</b>	.150" (3.81mm) Right Angle
<b>40</b>	.150" (3.81mm) Vertical

Snap-on Caps	
For Plunger A	
<b>F</b>	.201" (5.1mm) Diameter
<b>H</b>	.295" (7.5mm) Diameter
For Plunger B	
<b>B</b>	.315" (8.0mm) Diameter
<b>C</b>	.394" (10.0mm) Diameter

Cap Colors	
<b>A</b>	Black
<b>B</b>	White
<b>C</b>	Red
* <b>E</b>	Yellow
* <b>F</b>	Green
* <b>G</b>	Blue
* <b>H</b>	Gray
* For cap codes B & C only	

#### IMPORTANT:



Switches are supplied without UL, cULus & CSA marking unless specified. **UL, cULus & CSA recognized only when ordered with marking on the switch.** Specific models, ratings, & ordering instructions are noted on the General Specifications page.

#### DESCRIPTION FOR TYPICAL ORDERING EXAMPLE

**M2B15AA5G30-FC**



Toggles  
Rockers  
Pushbuttons  
Illuminated PB  
Programmable  
Keylocks  
Rotaries  
Slides  
Tactiles  
Tilt  
Touch  
Indicators  
Accessories  
Supplement

## POLES & CIRCUITS

Pole	Model	Plunger Position ( ) = Momentary		Connected Terminals		Throw & Schematics
		Normal	Down	Normal	Down	
						Note: Terminal numbers are not actually on the switch.
SP	M2B15	ON	(ON)	1-3	1-2	SPDT
DP	M2B25	ON	(ON)	1-3 4-6	1-2 4-5	DPDT

## PLUNGERS

**A** .282" (7.16mm) Long

For cap codes F & H

Material:  
Chrome over brass

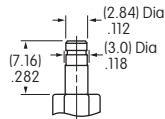

**B** .307" (7.8mm) Long

For cap codes B & C

Material:  
Chrome over brass

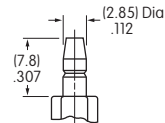

## BUSHING

**A5** .250" (6.35mm) Double Flatted

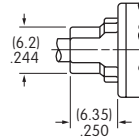
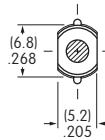

## CONTACT MATERIALS & RATINGS

**W** Silver over Silver      Power Level      1A @ 125V AC & 1A @ 30V DC

**G** Gold over Brass or Copper      Logic Level      0.4VA maximum @ 28V AC/DC maximum

Complete explanation of operating range in Supplement section.

**A** Gold over Silver      Power Level or Logic Level      1A @ 125V AC or 0.4VA maximum @ 28V AC/DC maximum

Note: This dual rated option is suitable when two or more identical switches are used in logic and in power circuits within the same application. See Supplement section for complete explanation of dual rating and operating range.

### PC TERMINALS

**03** Straight

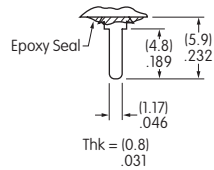

**13** Straight with .460" (11.7mm) Bracket

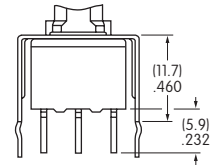

**30** .150" (3.81mm) Right Angle

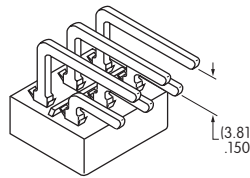

**40** .150" (3.81mm) Vertical

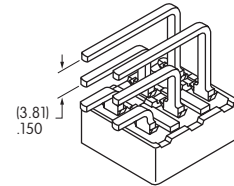

### SNAP-ON CAPS

#### For Plunger Type A

**F** AT475  
.201" (5.1mm) Diameter

Material: Polyamide

Colors Available:  
A, B, C

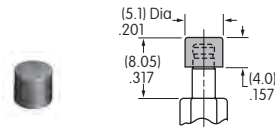

**H** AT496  
.295" (7.5mm) Diameter

Material: Polyamide

Colors Available:  
A, B, C

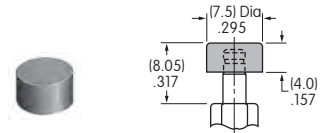

#### For Plunger Type B

**B** AT443  
.315" (8.0mm) Diameter

Material: Polycarbonate

Colors Available:  
A, B, C, E, F, G, H

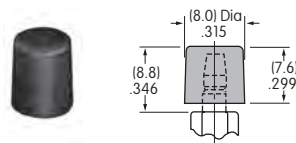

**C** AT442  
.394" (10.0mm) Diameter

Material: Polycarbonate

Colors Available:  
A, B, C, E, F, G, H

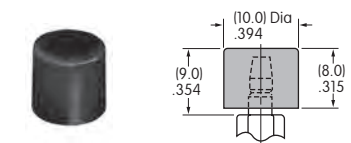

Cap Colors  
Codes:

**A** Black   **B** White   **C** Red   **E** Yellow   **F** Green   **G** Blue   **H** Gray

TYPICAL SWITCH DIMENSIONS

Single Pole

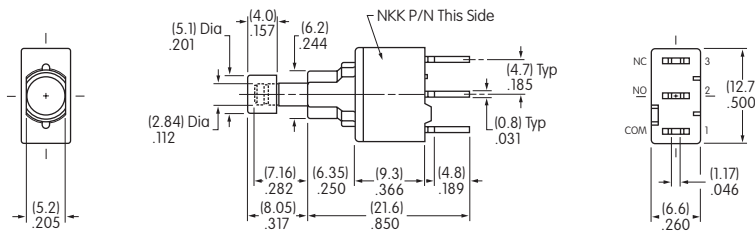

Straight PC

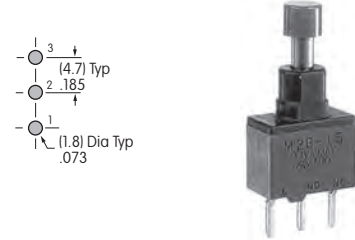

M2B15AA5G03-FC

Double Pole

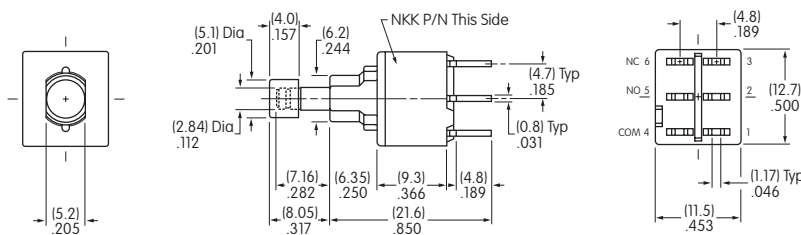

Straight PC

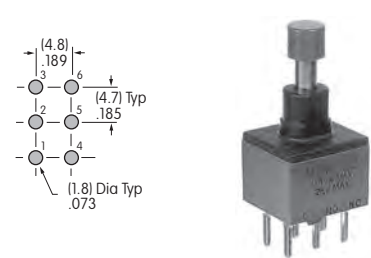

M2B25AA5G03-FC

Single & Double Pole

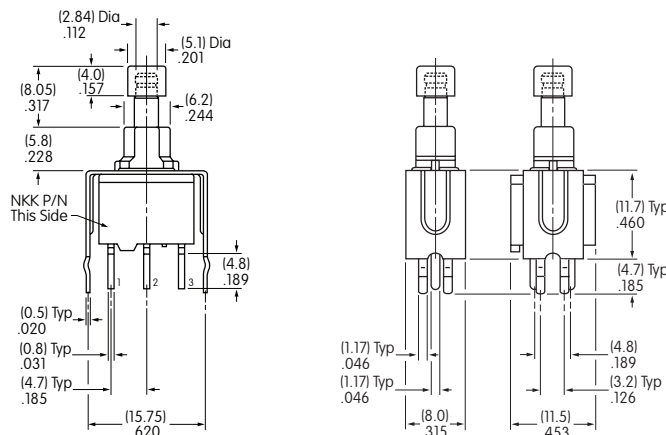

Straight PC • Bracket

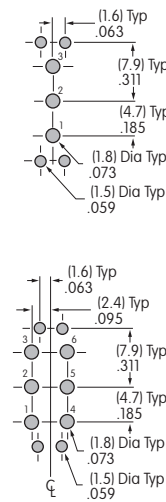

M2B15AA5G13-FC

## TYPICAL SWITCH DIMENSIONS

### Right Angle PC

### Single Pole

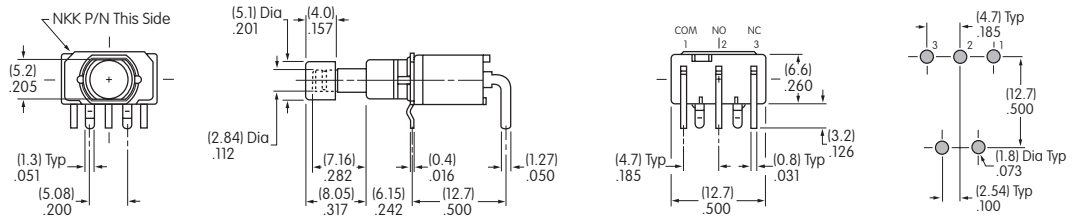

**M2B15AA5G30-FC**

### Right Angle PC

### Double Pole

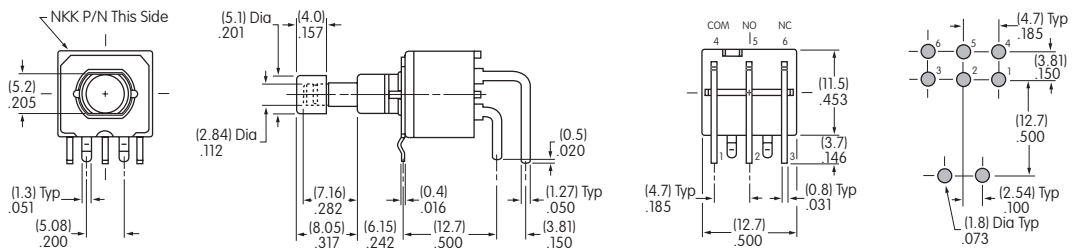

**M2B25AA5G30-FC**

### Vertical PC

### Single Pole

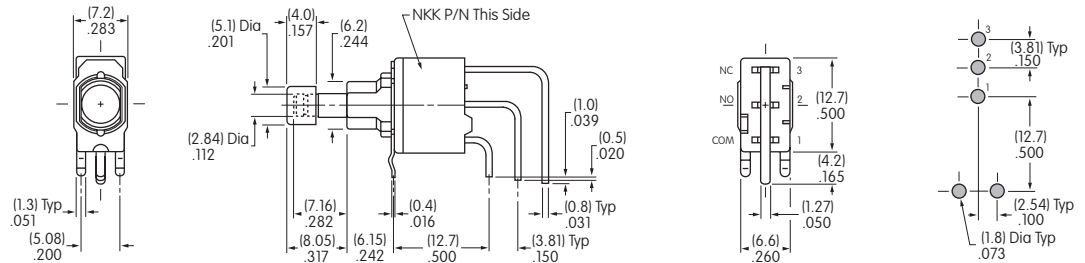

**M2B15AA5G40-FC**

### Vertical PC

### Double Pole

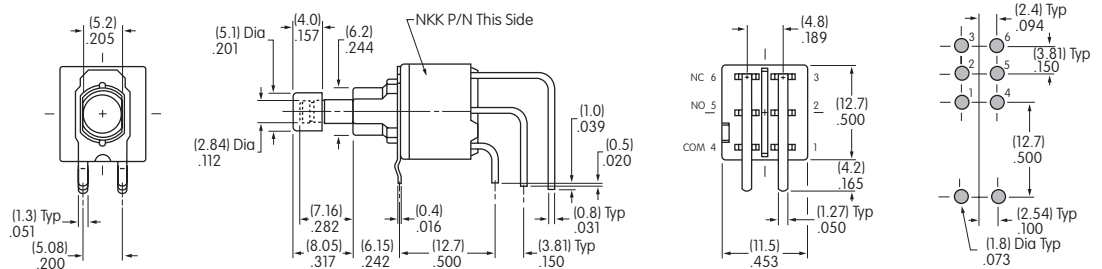

**M2B25AA5G40-FC**



# General Specifications

## Electrical Capacity (Resistive Load)

<b>Power Level (silver):</b>	6A @ 125V AC & 3A @ 250V AC or 3A @ 30V DC
<b>Logic Level (gold):</b>	0.4VA maximum @ 28V AC/DC maximum (Applicable Range 0.1mA ~ 0.1A @ 20mV ~ 28V)
<b>Logic/Power Level: (gold over silver)</b>	Combines silver & gold ratings

Note: Find additional explanation dual rating & operating range in Supplement section.

## Other Ratings

<b>Contact Resistance:</b>	10 milliohms maximum for silver; 20 milliohms maximum for gold
<b>Insulation Resistance:</b>	1,000 megohms minimum @ 500V DC
<b>Dielectric Strength:</b>	1,000V AC minimum between contacts for 1 minute minimum; 1,500V AC minimum between contacts & case for 1 minute minimum
<b>Mechanical Life:</b>	50,000 operations minimum for splashproof models; 100,000 for all other models
<b>Electrical Life:</b>	25,000 operations minimum for silver; 50,000 operations minimum for gold 50,000 operations minimum for silver at 3A @ 125V AC

**Nominal Operating Force:** Momentary Action: 1-pole 9.32N; 2-pole 16.18N; 4-pole 25.54N;  
Alternate Action: 1-pole 4.41N; 2-pole 7.06N; 4-pole 11.77N

<b>Contact Timing:</b>	Slow make, slow break		
<b>Plunger Travel:</b>	Screw-on Cap (Mom.)	Screw-on Cap (Alt.)	Snap-on Cap (Mom. & Alt.)
<b>Pretravel:</b>	.028" (0.71mm)	.110" (2.80mm)	.125" (3.19mm)
<b>Overtravel:</b>	.043" (1.09mm)	.043" (1.10mm)	.050" (1.26mm)
<b>Total Travel</b>	.071" (1.80mm)	.153" (3.90mm)	.175" (4.45mm)

## Materials & Finishes

<b>Plunger:</b>	Brass w/nickel plating; polyacetal w/B1 bushing	<b>Bushing:</b>	Brass with nickel plating
<b>Frame:</b>	Stainless steel	<b>Case:</b>	Diallyl phthalate resin (UL94V-0)
<b>Movable Contactor:</b>	Phosphor bronze with silver or gold plating		
<b>Movable Contacts:</b>	Silver alloy (code W); copper with gold plating (code G); or silver alloy with gold plating (code A)		
<b>Stationary Contacts:</b>	Silver with silver plating (code W); copper or brass with gold plating (code G); or silver with gold plating (code A)		
<b>Terminals:</b>	Copper or brass with silver plating; copper or brass with gold plating		

## Environmental Data

<b>Operating Temp Range:</b>	-30°C through +85°C (-22°F through +185°F)
<b>Humidity:</b>	90 ~ 95% humidity for 96 hours @ 40°C (104°F)
<b>Vibration:</b>	10 ~ 55Hz with peak-to-peak amplitude of 1.5mm traversing the frequency range & returning in 1 minute; 3 right angled directions for 2 hours
<b>Shock:</b>	50G (490m/s <sup>2</sup> ) acceleration (tested in 6 right angled directions, with 5 shocks in each direction)
<b>Sealing:</b>	B3 & D3 bushing options equivalent to IP67

## Installation

<b>Mounting Torque:</b>	1.5Nm (13.0 lb•in) for double nut; .7Nm (6.0 lb•in) for single nut
<b>Cap Installation Force:</b>	80.0N (18.0 lbf) maximum downward force on actuator
<b>Soldering Time &amp; Temp:</b>	Wave Soldering (PC version): See Profile A in Supplement section. Manual Soldering: See Profile A in Supplement section.
<b>Process Seal:</b>	These devices are not process sealed. Hand clean locally using alcohol based solution.

## Standards & Certifications

<b>Flammability Standards:</b>	UL94V-0 case
<b>UL:</b>	<b>File No. E44145 - Recognized only when ordered with marking on switch.</b> Add "/U" or "/CUL" before dash in part number to order UL recognized switch. All models recognized at 6A @ 125V AC or 3A @ 250V AC or 0.4VA max. @ 28V DC max.
<b>CSA:</b>	<b>File No. 023535_0_000 - Certified only when ordered with marking on switch.</b> Add "/C" before dash in part number to order CSA certified switch. All models certified at 6A @ 125V AC or 3A @ 250V AC or 0.4VA max. @ 28V max.



# Distinctive Characteristics

Guide interlocked with actuator block prevents window locking and maintains correct plunger alignment to assure contact stability.

Employs an over-center actuator mechanism, which diminishes sparking and increases operating life in AC circuits.

High torque bushing construction prevents rotation or separation from frame during installation.

Splashproof option (D3 and B3 bushing codes) features an o-ring within the bushing and one under the face nut to protect from splashed, sprayed, or spilled liquids.

High insulating barriers, formed in the molded diallyl phthalate case, increase isolation of circuits in multipole devices.

Prominent external insulating barriers increase insulation resistance and dielectric strength.

Epoxy sealed terminals prevent entry of solder flux and other contaminants.

Clinching of the frame to the case well above the base and terminals provides 1,500V dielectric strength.

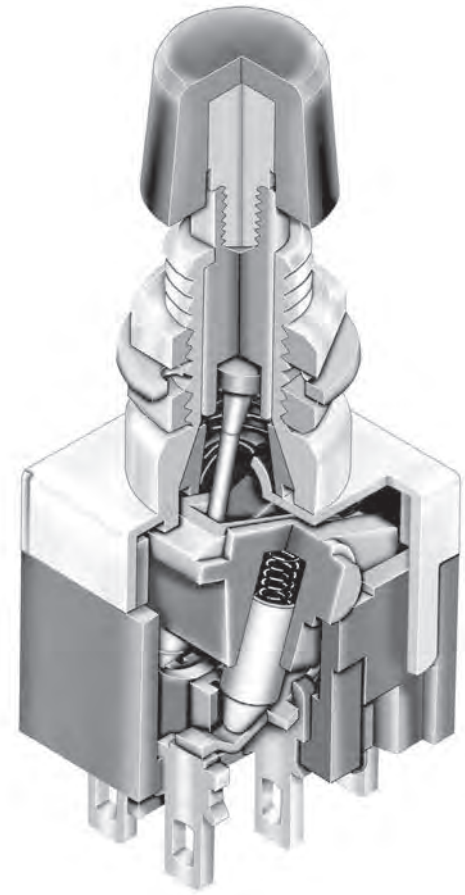

Actual Size

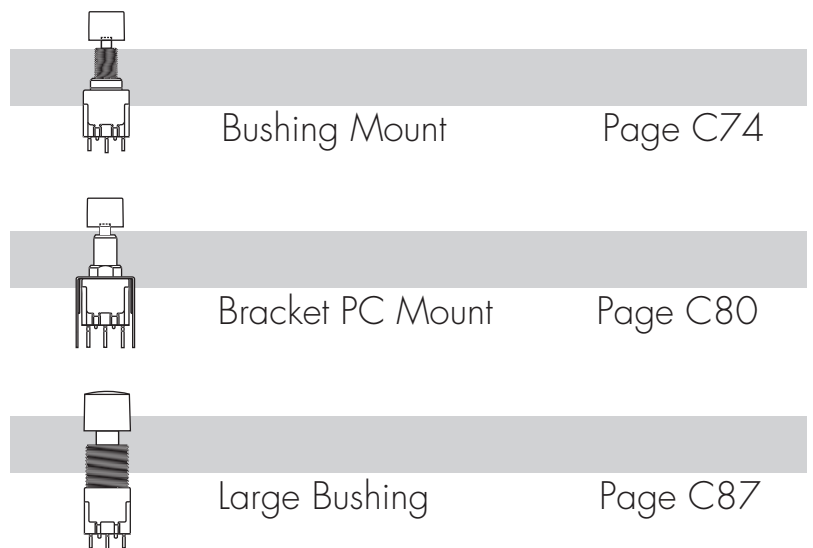
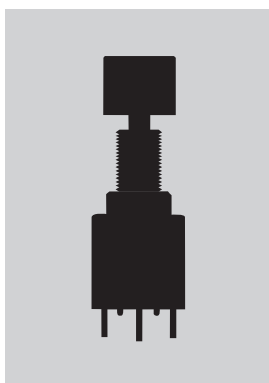

Bushing Mount Page C74

Bracket PC Mount Page C80

Large Bushing Page C87

### TYPICAL SWITCH ORDERING EXAMPLE

**MB 2011 S S1 W 01 — C A**

Poles & Circuits			
2011	SPDT	ON	(ON)
2065	SPDT	ON	ON
2061	DPDT	ON	(ON)
2085	DPDT	ON	ON
2181	4PDT	ON	(ON)
2185	4PDT	ON	ON

( ) = Momentary

Contact Materials & Ratings	
W	Silver Rated 6A @ 125V AC & 3A @ 250V AC
G	Gold Rated 0.4VA max @ 28V AC/DC max
A	Gold over Silver Rated 6A @ 125V AC & 0.4VA max @ 28V AC/DC max

Caps	
B	.315" (8.0mm) Diameter
C	.394" (10.0mm) Diameter

Cap Colors	
A	Black
B	White
C	Red
E	Yellow
F	Green
G	Blue
H	Gray

Plunger Types	
S	Plunger for Screw-on Caps
L	Plunger for Snap-on Caps

Bushings	
S1	.335" (8.5mm) Threaded with Keyway
S2	.335" (8.5mm) Smooth with Keyway
S4	.335" (8.5mm) Metric Threaded with Keyway
D1	.335" (8.5mm) Threaded with D-Flat
D3	.335" (8.5mm) Threaded Splashproof without Keyway

Terminals	
01	Solder Lug
02	Quick Connect
03	.250" (6.35mm) Straight PC
05	.425" (10.8mm) Wirewrap
06	.750" (19.05mm) Wirewrap
07	.964" (24.5mm) Wirewrap
08	1.062" (27.0mm) Wirewrap





#### IMPORTANT:

Switches are supplied without UL, cULus & CSA marking unless specified. **UL, cULus & CSA recognized only when ordered with marking on the switch.** Specific models, ratings, & ordering instructions are noted on the General Specifications page.

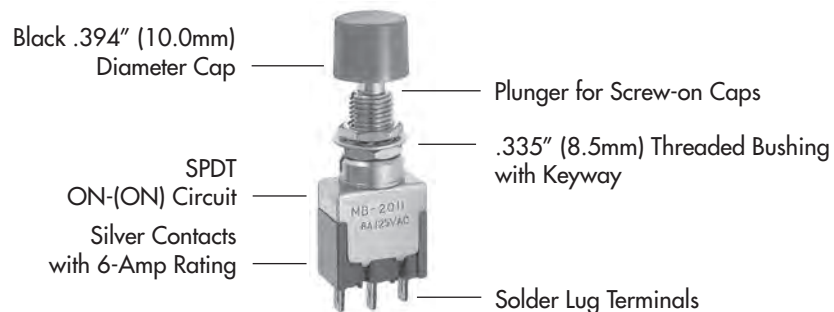
#### DESCRIPTION FOR TYPICAL ORDERING EXAMPLE

**MB2011S1W01-CA**

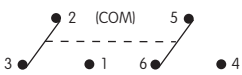
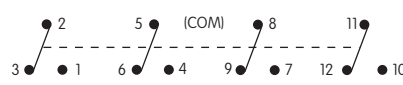

POLES & CIRCUITS						
Pole	Model	Plunger Position ( ) = Momentary		Connected Terminals		Throw & Switch Schematics
		Normal  Keyway	Down 	Normal  Keyway	Down 	
SP	MB2011	ON	(ON)	2-3	2-1	SPDT 
	MB2065	ON	ON			
DP	MB2061	ON	(ON)	2-3 5-6	2-1 5-4	DPDT 
	MB2085	ON	ON			
4P	MB2181	ON	(ON)	2-3 5-6 8-9 11-12	2-1 5-4 8-7 11-10	4PDT 
	MB2185	ON	ON			

## PLUNGER TYPES

On alternate action models, after transferring circuit, the plunger returns to its original position and does not latch down.



### Plunger for Screw-on Caps

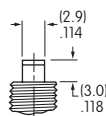

Momentary Plunger Length

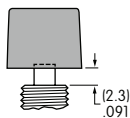

Momentary Cap Location

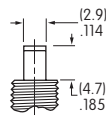

Alternate Plunger Length

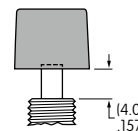

Alternate Cap Location



### Plunger for Snap-on Caps

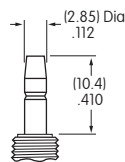

Momentary & Alternate Plunger Length

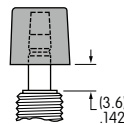

Momentary & Alternate Cap Location

## BUSHINGS

**S1** .335" (8.5mm)  
Threaded with Keyway

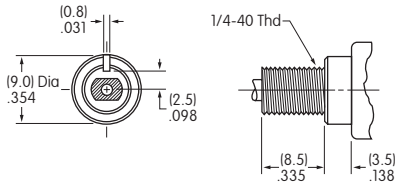

**S2** .335" (8.5mm)  
Smooth with Keyway

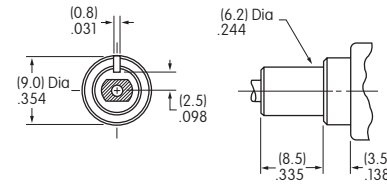

**S4** .335" (8.5mm) Metric  
Threaded with Keyway

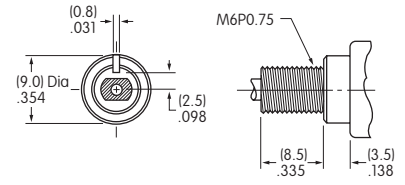

Maximum Panel Thickness with  
Standard Hardware: .154" (3.9mm)

Maximum Panel Thickness with  
Standard Hardware: .154" (3.9mm)

**D1** .335" (8.5mm)  
Threaded with D Flat

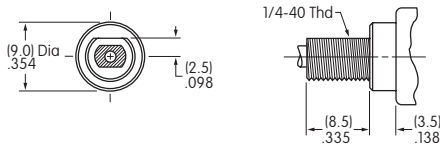

Maximum Panel Thickness with  
Standard Hardware: .154" (3.9mm)

**D3** .335" (8.5mm)  
Threaded Splashproof without Keyway

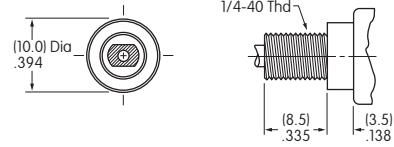

Maximum Panel Thickness with  
Standard Hardware: .240" (6.1mm)

### Panel Cutouts

For S1, S2, or S4 Bushing  
with  
Keyway

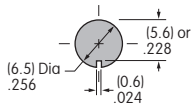

For S1 or S4 Bushing  
with  
Optional Locking Ring

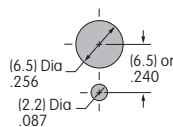

For D1 Bushing  
with  
D Flat

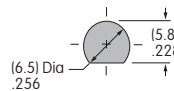

For D3 Bushing  
without  
Keyway

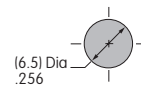

Standard hardware for bushings S1, S4, & D1 includes 2 hex nuts & 1 lockwasher; D3 bushing has 1 hex nut & 1 o-ring.  
Standard & optional hardware are illustrated following the Typical Switch Dimension drawings.

## CONTACT MATERIALS & RATINGS

**W** Silver over Silver      Power Level      6A @ 125V AC & 3A @ 250V AC

**G** Gold over Brass or Copper      Logic Level      0.4VA maximum @ 28V AC/DC maximum  
Note: Complete explanation of operating range in Supplement section.

**A** Gold over Silver      Power Level  
or Logic Level      6A @ 125V AC & 3A @ 250V AC  
or 0.4VA maximum @ 28V AC/DC maximum

Note: This dual rated option is suitable when two or more identical switches are used in logic and in power circuits within the same application. See Supplement section for complete explanation of dual rating and operating range.

Toggles  
Rockers  
Pushbuttons  
Illuminated PB  
Programmable  
Keylocks  
Rotaries  
Slides  
Tactiles  
Tilt  
Touch  
Indicators  
Accessories  
Supplement

## TERMINALS

Toggle

Rockers

**C** Pushbuttons

Programmable PB

Programmable

Illuminated PB

Key locks

Rotaries

Slides

Tactiles

Tilt

Touch

Indicators

Accessories

Supplement

**01** Solder Lug

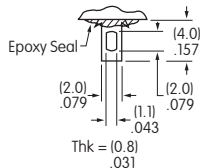

**02** .062" (1.57mm) Wide Quick Connect

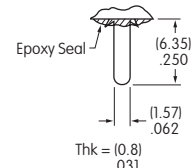

**03** .250" (6.35mm) Straight PC

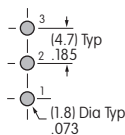
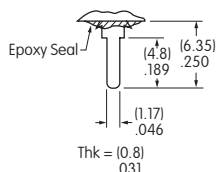

Single Pole

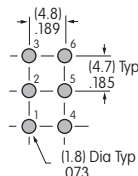

Double Pole

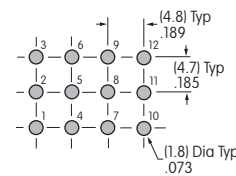

Four Pole

**05** .425" (10.8mm) Wirewrap or Extended PC

**06** .750" (19.05mm) Wirewrap or Extended PC

**07** .964" (24.5mm) Wirewrap or Extended PC

**08** 1.062" (27.0mm) Wirewrap or Extended PC

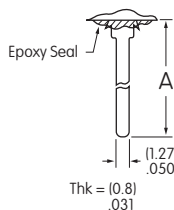

If using as extended PC terminal, refer to the above footprints.

Dimension A = terminal lengths as shown beside the terminal codes at the left.

## CAPS & CAP COLORS

**B** AT413  
.315" (8.0mm) Diameter  
Screw-on Cap

AT443  
.315" (8.0mm) Diameter  
Snap-on Cap

**C** AT407  
.394" (10.0mm) Diameter  
Screw-on Cap

AT442  
.394" (10.0mm) Diameter  
Snap-on Cap

For use with Plunger Code S

For use with Plunger Code L

For use with Plunger Code S

For use with Plunger Code L

Cap Material: PBT  
Finish: Glossy

Cap Material: Polycarbonate  
Finish: Glossy

Cap Material: PBT  
Finish: Glossy

Cap Material: Polycarbonate  
Finish: Glossy

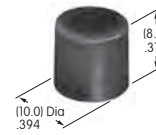
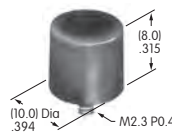
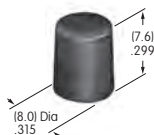
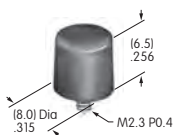

Cap Colors Available:

**A**

Black

**B**

White

**C**

Red

**E**

Yellow

**F**

Green

**G**

Blue

**H**

Gray

## TYPICAL SWITCH DIMENSIONS

### Solder Lug

### Single Pole

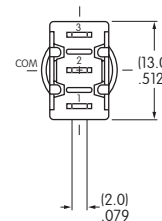
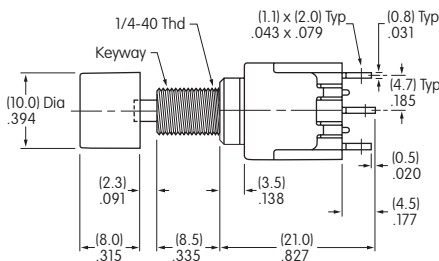
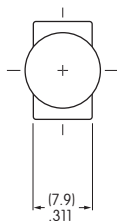

MB2011SS1W01-CA

### Solder Lug

### Double Pole

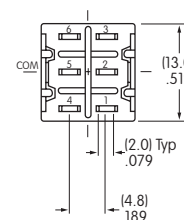
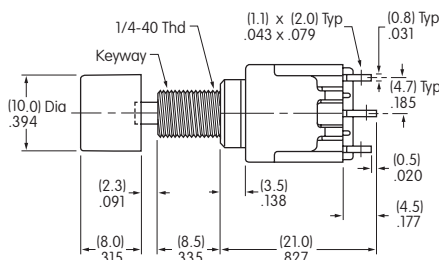
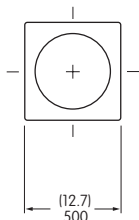

MB2061SS1W01-CA

### Solder Lug

### Four Pole

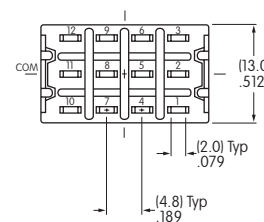
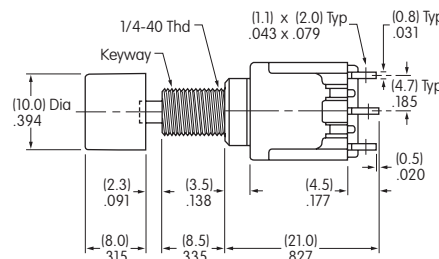
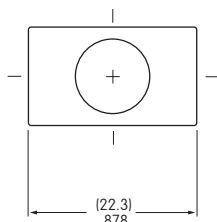

MB2181SS1W01-CA

## HARDWARE

### Standard Hardware

### Optional Hardware

#### AT513H for Inch AT513M for Metric Hexagon Nut

2 included with each switch  
(1 with splashproof models)

Material:  
Brass with Nickel plating

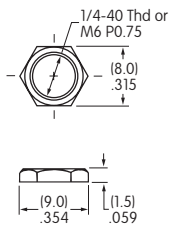

#### AT509 Lockwasher

1 included with each switch  
(not with splashproof models)

Material:  
Steel with Zinc/Chromate

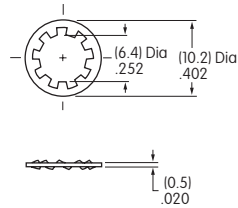

#### AT516 O-ring for Splashproof Bushing

1 included with  
each splashproof model

Material:  
Nitrile butadiene rubber

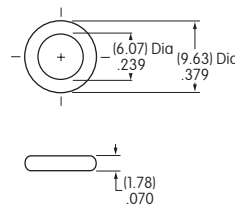

#### AT507H for Inch AT507M for Metric Locking Ring

Material:  
Steel with Zinc/Chromate

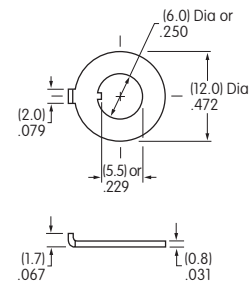

### Optional Mounting Collars/Conical Nuts

### Optional Splashproof Boots for S Plunger

#### AT512H for Inch AT512M for Metric Conical Nut

Used with .315" (8.0mm)  
Diameter Cap (cap code B)  
Material:  
Brass with chrome plating

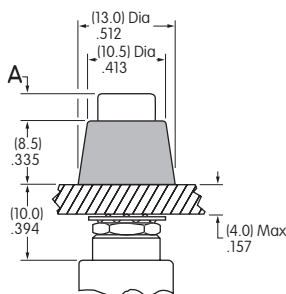

#### AT512CH for Inch AT512CM for Metric Conical nut

Used with .394" (10.0mm)  
Diameter Cap (cap code C)  
Material:  
Brass with chrome plating

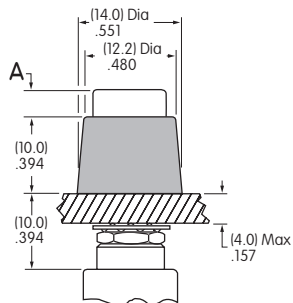

#### AT4041H for Inch AT4041M for Metric Boot for Momentary

Material:  
Silicone rubber

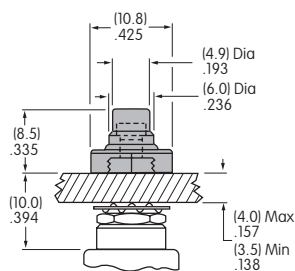

#### AT4042H for Inch AT4042M for Metric Boot for Alternate

Material:  
Silicone rubber

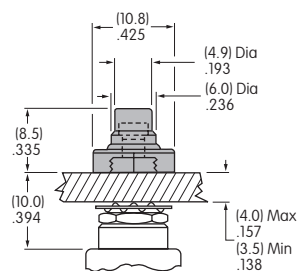

Dimension A = Cap Height

.091" (2.3mm) for Momentary with Plunger Code S  
.157" (4.0mm) for Alternate with Plunger Code S  
.142" (3.6mm) for Momentary & Alternate with Plunger Code L

Operating Life 100,000

Boots for momentary devices  
are accompanied by a threaded  
adaptor which extends the length  
of the plunger.

Operating Life 30,000

### TYPICAL SWITCH ORDERING EXAMPLE

**MB**

**2011**

**S**

**S2**

**G**

**13**

**C**

**A**

#### Poles & Circuits

<b>2011</b>	SPDT	ON	(ON)
<b>2065</b>	SPDT	ON	ON
<b>2061</b>	DPDT	ON	(ON)
<b>2085</b>	DPDT	ON	ON
<b>2181</b>	4PDT	ON	(ON)
<b>2185</b>	4PDT	ON	ON

( ) = Momentary

4-pole not for use with right angle terminals

#### Contact Materials & Ratings

<b>W</b>	Silver Rated 6A @ 125V AC & 3A @ 250V AC
<b>G</b>	Gold Rated 0.4VA max @ 28V AC/DC max
<b>A</b>	Gold over Silver Rated 6A @ 125V AC & 0.4VA max @ 28V AC/DC max

#### Caps

<b>B</b>	.315" (8.0mm) Diameter
<b>C</b>	.394" (10.0mm) Diameter

#### Cap Colors

<b>A</b>	Black
<b>B</b>	White
<b>C</b>	Red
<b>E</b>	Yellow
<b>F</b>	Green
<b>G</b>	Blue
<b>H</b>	Gray

#### Plunger Type

<b>S</b>	Plunger for Screw-on Caps
----------	---------------------------

#### Bushings

<b>S2</b>	.335" (8.5mm) Smooth with Keyway
<b>S1</b>	.335" (8.5mm) Threaded with Keyway
<b>A2</b>	.200" (5.08mm) Smooth with Keyway Only Available in Part Numbers MB2011SA2G31 & MB2011SA2W31

#### Terminals

<b>13</b>	.250" (6.35mm) Straight PC with Bracket
<b>40</b>	.150" (3.81mm) Vertical PC
<b>45</b>	.100" (2.54mm) Vertical PC
<b>30</b>	Right Angle PC with .646" (16.4mm) Support to Terminals Available in 1- & 2-pole only
<b>31</b>	Right Angle PC with .500" (12.7mm) Support to Terminals Available in 1-pole only

#### IMPORTANT:

Switches are supplied without UL, cULus & CSA marking unless specified.

**UL, cULus & CSA recognized only when ordered with marking on the switch.**

Specific models, ratings, & ordering instructions are noted on the General Specifications page.

#### DESCRIPTION FOR TYPICAL ORDERING EXAMPLE

### MB2011S2G13-CA

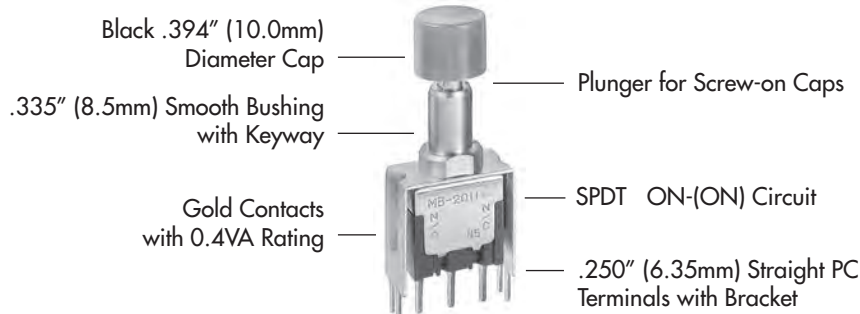



POLES & CIRCUITS

Pole	Model	Plunger Position ( ) = Momentary		Connected Terminals		Throw & Switch Schematics
		Normal	Down	Normal	Down	
						Note: Terminal numbers are not actually on the switch.
SP	MB2011 MB2065	ON ON	(ON) ON	2-3	2-1	SPDT 
DP	MB2061 MB2085	ON ON	(ON) ON	2-3 5-6	2-1 5-4	DPDT 
4P	MB2181 MB2185	ON ON	(ON) ON	2-3 5-6 8-9 11-12	2-1 5-4 8-7 11-10	4PDT 

PLUNGER TYPE

On alternate action models, after transferring circuit, the plunger returns to its original position and does not latch down.

S

Plunger for Screw-on Caps

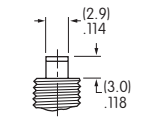

Momentary Plunger Length

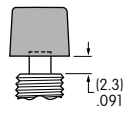

Momentary Cap Location

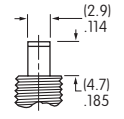

Alternate Plunger Length

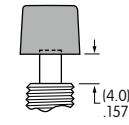

Alternate Cap Location

BUSHINGS

S2

.335" (8.5mm)  
Smooth with Keyway

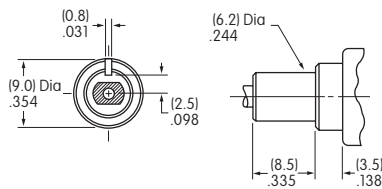

S1

.335" (8.5mm)  
Threaded with Keyway

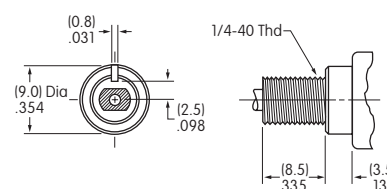

A2

.200" (5.08mm)  
Smooth with Keyway

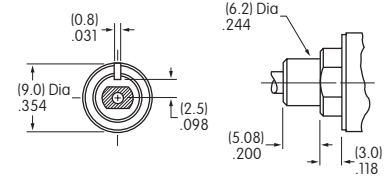

Standard hardware: 2 hex nuts (AT513H) & 1 lockwasher (AT509)  
Optional hardware: Locking ring (AT507)

Only available in part numbers MB2011SA2W31 & MB2011SA2G31

Panel Cutouts

For S2, S1, or A2 Bushing with Keyway

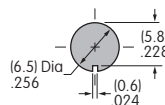

With Optional Locking Ring

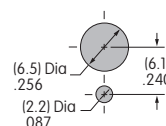

Maximum Panel Thickness with Standard Hardware: .154" (3.9mm)

### CONTACT MATERIALS & RATINGS

<b>W</b>	Silver over Silver	Power Level	6A @ 125V AC & 3A @ 250V AC
<b>G</b>	Gold over Brass or Copper	Logic Level	0.4VA maximum @ 28V AC/DC maximum Note: Complete explanation of operating range in Supplement section.
<b>A</b>	Gold over Silver	Power Level or Logic Level	6A @ 125V AC & 3A @ 250V AC or 0.4VA maximum @ 28V AC/DC maximum Note: This dual rated option is suitable when two or more identical switches are used in logic and in power circuits within the same application. See Supplement section for complete explanation of dual rating and operating range.

### TERMINALS

<b>13</b>	.250" (6.35mm) Straight PC with Bracket	<b>40</b>	.150" (3.81mm) Vertical PC	<b>45</b>	.100" (2.54mm) Vertical PC
<b>30</b>	Right Angle PC with .646" (16.4mm) Support to Terminal	<b>31</b>	Right Angle PC with .500" (12.7mm) Support to Terminal		

Only Available in 1 & 2 Pole

Note: Full dimensioned drawings appear on the following pages.

### CAPS & CAP COLORS

<b>B</b>	AT413 .315" (8.0mm) Diameter Screw-on Cap		<b>C</b>	AT407 .394" (10.0mm) Diameter Screw-on Cap	
Cap Material: PBT Finish: Glossy			Cap Material: PBT Finish: Glossy		

Cap Colors Available: **A** Black **B** White **C** Red **E** Yellow **F** Green **G** Blue **H** Gray

Toggles  
 Rockers  
 Pushbuttons  
 Illuminated PB  
 Programmable  
 Keylocks  
 Rotaries  
 Slides  
 Tactiles  
 Tilt  
 Touch  
 Indicators  
 Accessories  
 Supplement

## TYPICAL SWITCH DIMENSIONS

### Single Pole

### Straight PC with Bracket

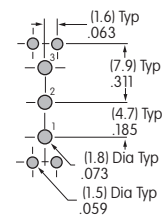
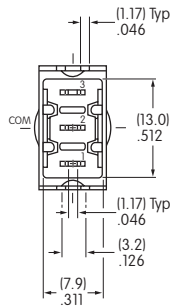
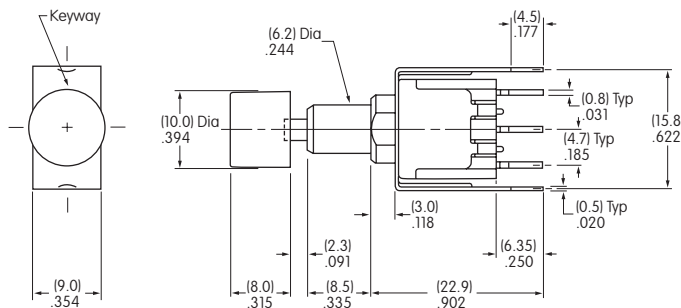

**MB2011SS2G13-CA**

### Double Pole

### Straight PC with Bracket

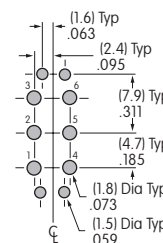
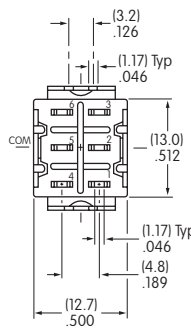
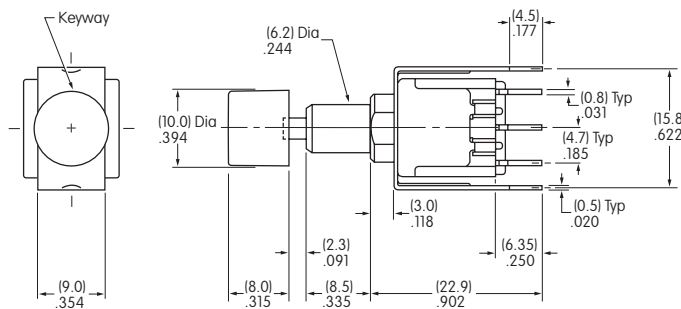

**MB2061SS2G13-CA**

### Four Pole

### Straight PC with Bracket

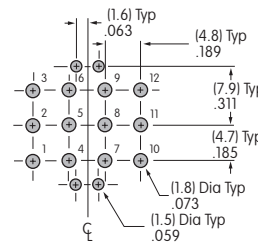
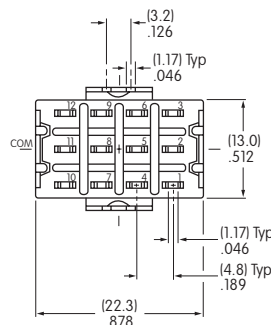
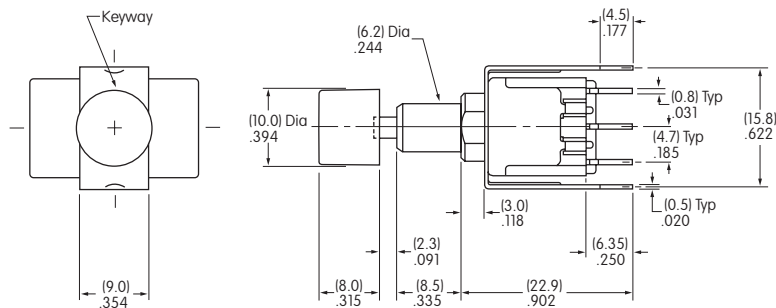

**MB2181SS2G13-CA**

## TYPICAL SWITCH DIMENSIONS

### .150" (3.81mm) Vertical PC

### Single Pole

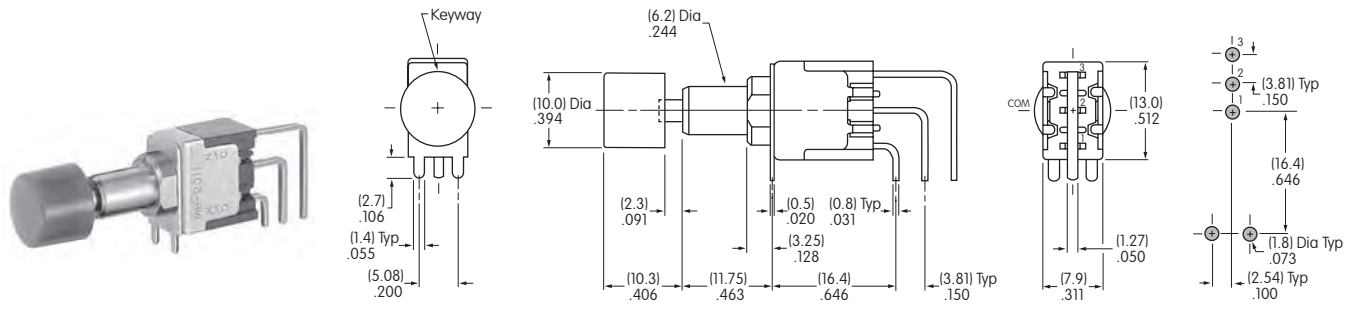

MB2011SS2G40-CA

### .150" (3.81mm) Vertical PC

### Double Pole

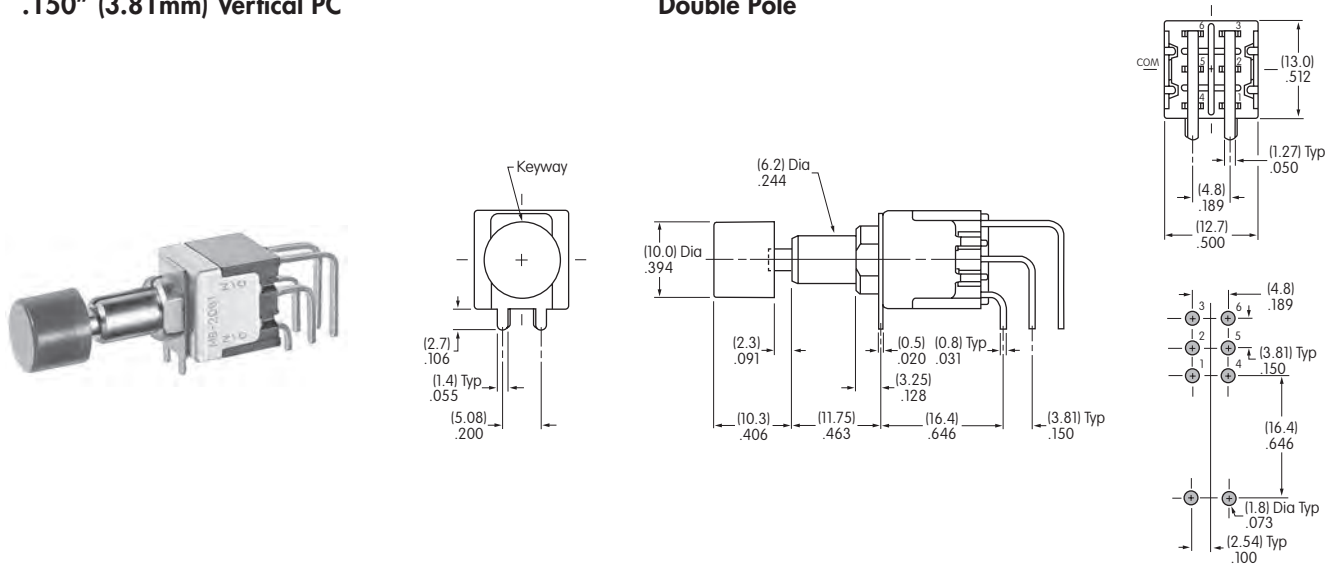

MB2061SS2G40-CA

### .150" (3.81mm) Vertical PC

### Four Pole

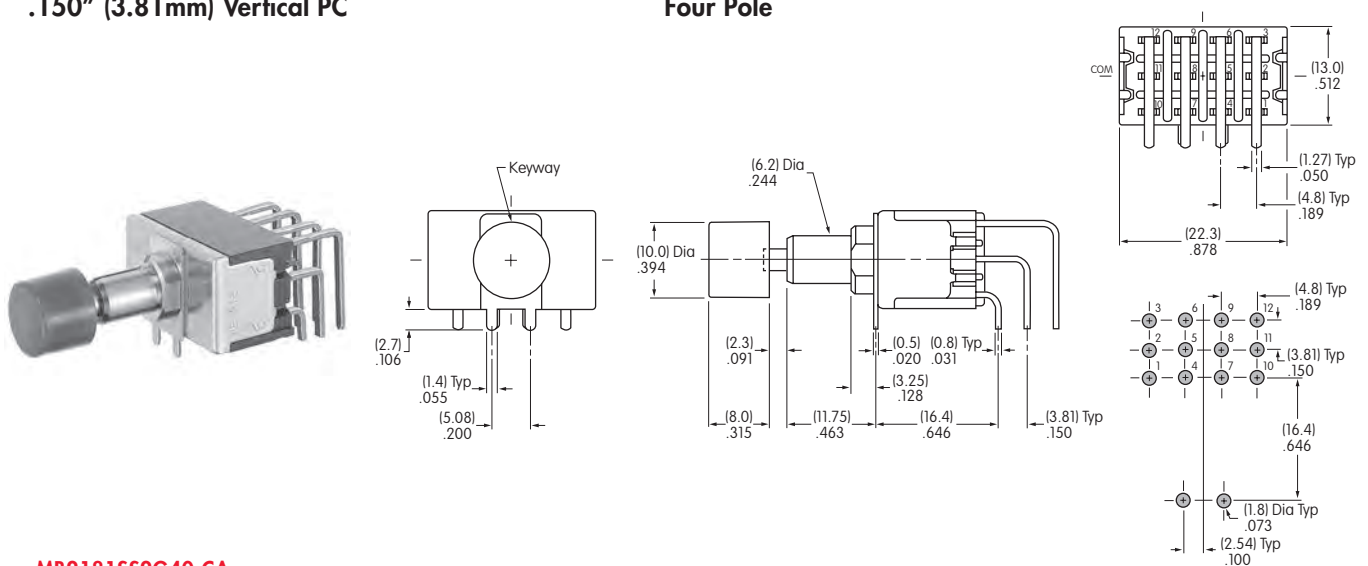

MB2181SS2G40-CA

TYPICAL SWITCH DIMENSIONS

Single Pole

.100" (2.54mm) Vertical PC

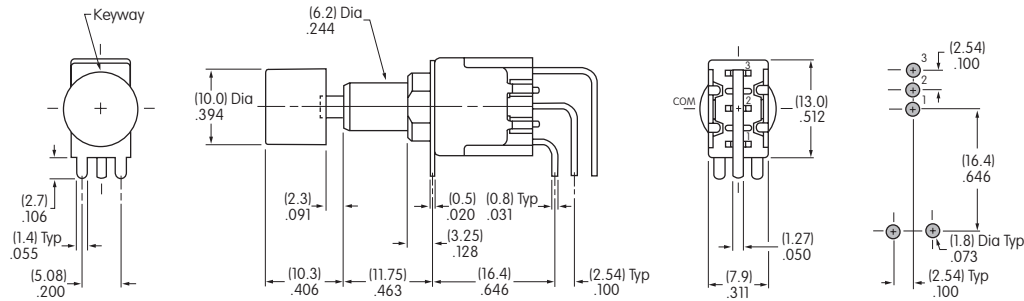

MB2011SS2G45-CA

Double Pole

.100" (2.54mm) Vertical PC

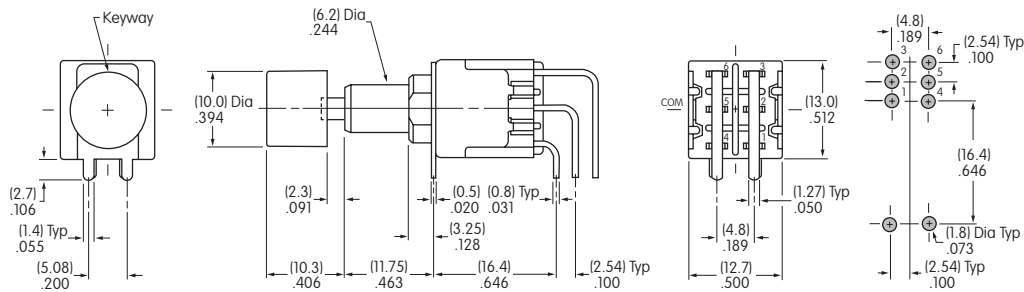

MB2061SS2G45-CA

Four Pole

.100" (2.54mm) Vertical PC

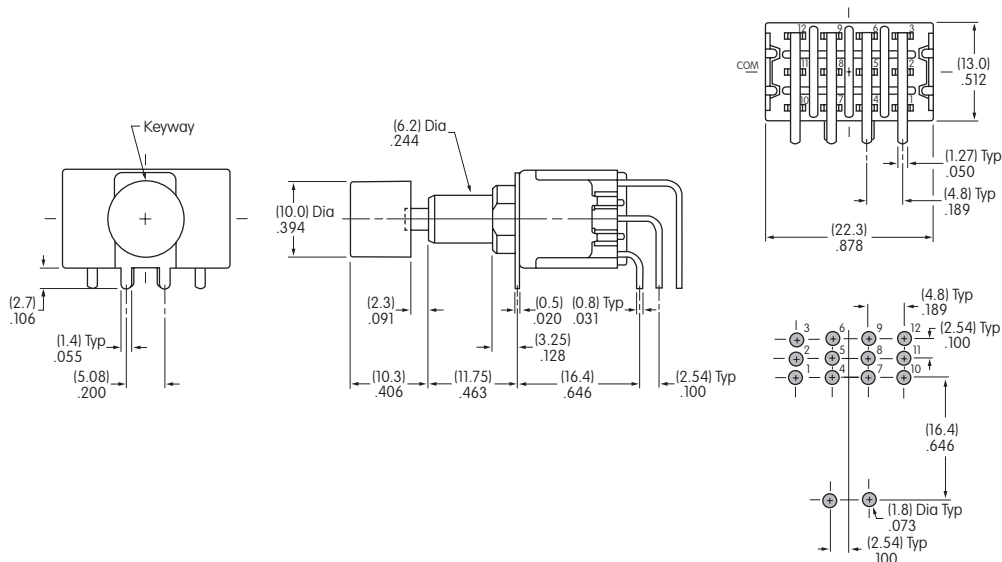

MB2181SS2G45-CA

- Toggle
- Rockers
- Pushbuttons**
- Illuminated PB
- Programmable
- Key locks
- Rotaries
- Slides
- Tactiles
- Tilt
- Touch
- Indicators
- Accessories
- Supplement

## TYPICAL SWITCH DIMENSIONS

### Right Angle PC

### Single Pole

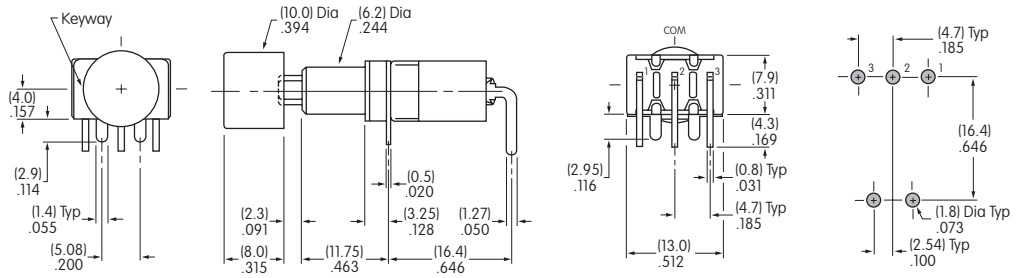

**MB2011SS2G30-CA**

### Right Angle PC

### Double Pole

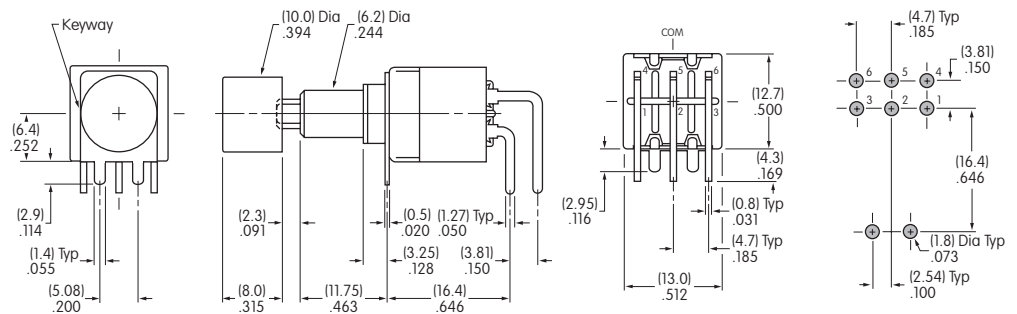

**MB2061SS2G30-CA**

### Right Angle PC with .500" (12.7mm) Support to Terminal

### Single Pole

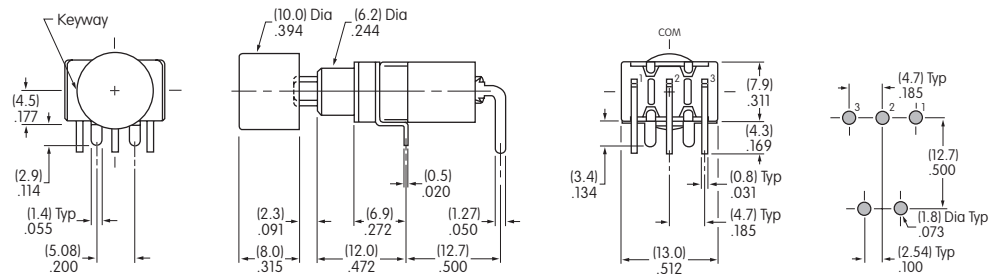

**MB2011SA2G31-CA**

TYPICAL SWITCH ORDERING EXAMPLE

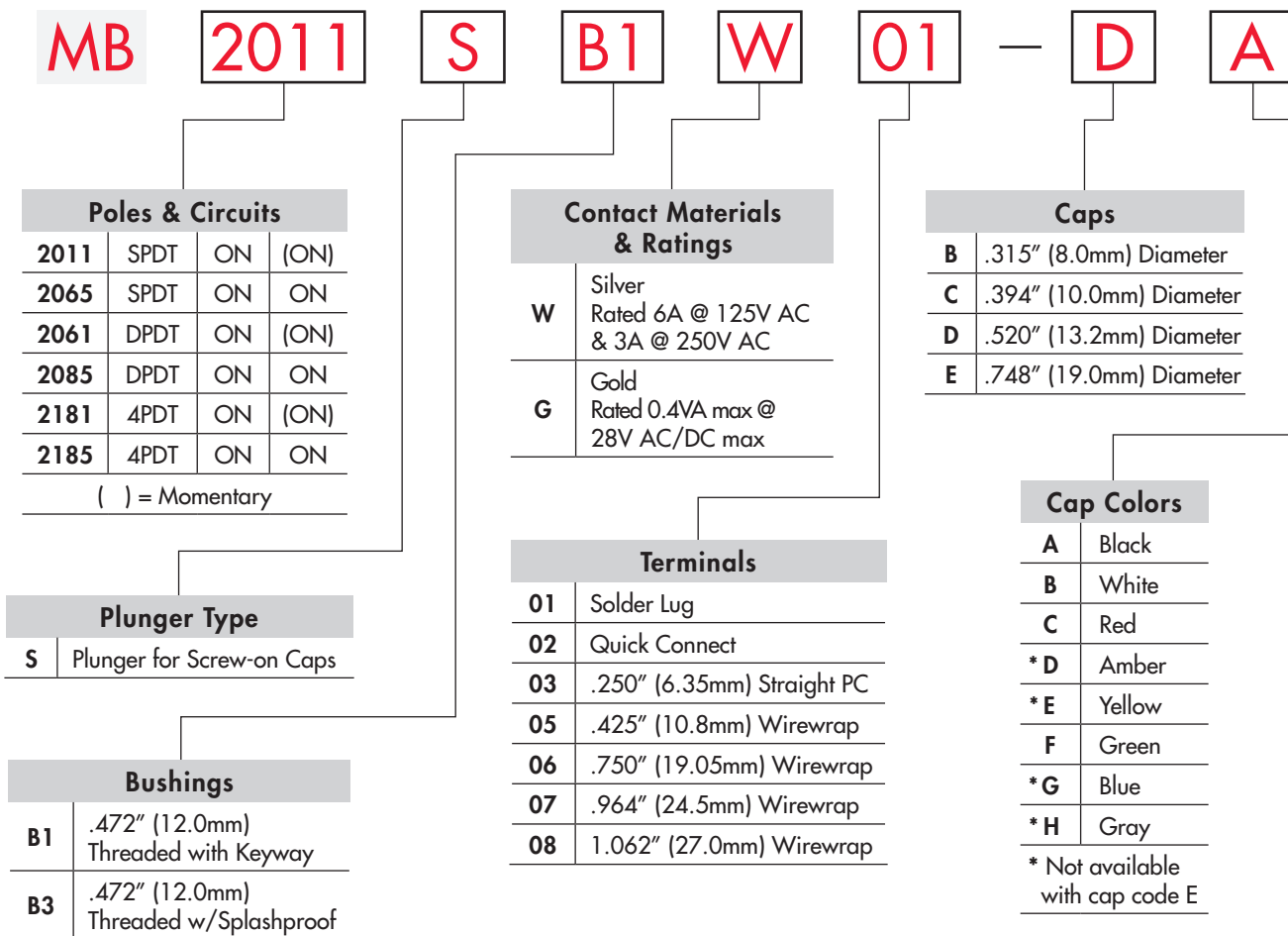

**IMPORTANT:**





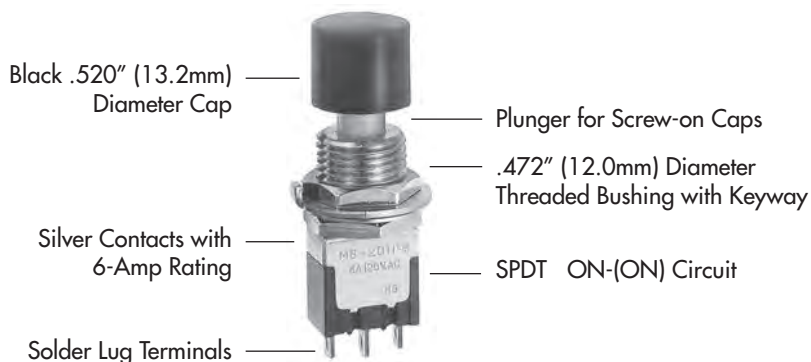

Switches are supplied without UL, cULus & CSA marking unless specified. **UL, cULus & CSA recognized only when ordered with marking on the switch.** Specific models, ratings, & ordering instructions are noted on the General Specifications page.

DESCRIPTION FOR TYPICAL ORDERING EXAMPLE

**MB2011SB1W01-DA**

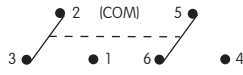
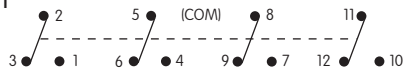

## POLES & CIRCUITS

		Plunger Position ( ) = Momentary		Connected Terminals		Throw & Switch Schematics
Pole	Model	Normal  Keyway	Down 	Normal  Keyway	Down 	Note: Terminal numbers are not actually on the switch.
SP	MB2011	ON	(ON)	2-3	2-1	SPDT 
	MB2065	ON	ON			
DP	MB2061	ON	(ON)	2-3 5-6	2-1 5-4	DPDT 
	MB2085	ON	ON			
4P	MB2181	ON	(ON)	2-3 5-6 8-9 11-12	2-1 5-4 8-7 11-10	4PDT 
	MB2185	ON	ON			

## PLUNGER TYPE

**S** Plunger for Screw-on Caps  
Plunger is plastic for B1 bushing.

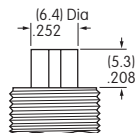

Plunger is metal for B3 bushing.

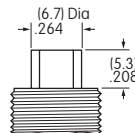

On alternate action models, after transferring circuit, the plunger returns to its original position, and does not latch down.

## BUSHINGS

**B1** .472" (12.0mm) Diameter Threaded with Keyway

Maximum Panel Thickness with Standard Hardware: .217" (5.5mm)

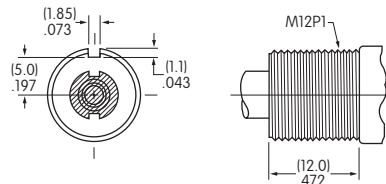

**B3** .472" (12.0mm) Diameter Threaded Splashproof

Maximum Panel Thickness with Standard Hardware: .217" (5.5mm)

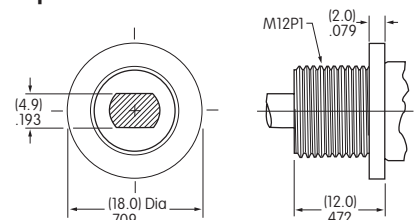

## Panel Cutouts

For B1 Bushing with Keyway

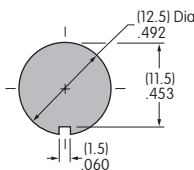

For B1 Bushing with Locking Ring

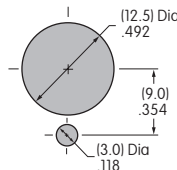

For B3 Bushing without Keyway

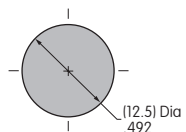

## CONTACT MATERIALS & RATINGS

**W** Silver over Silver

Power Level

6A @ 125V AC & 3A @ 250V AC

**G** Gold over Brass or Copper

Logic Level

0.4VA maximum @ 28V AC/DC maximum

Note: Complete explanation of operating range in Supplement section.



## TERMINALS

Toggle

Rockers

**C** Pushbuttons

Programmable Illuminated PB

Key locks

Rotaries

Slides

Tactiles

Tilt

Touch

Indicators

Accessories

Supplement

**01** Solder Lug

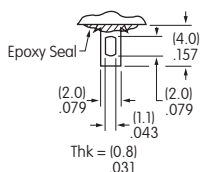

**02** .062" (1.57mm) Wide Quick Connect

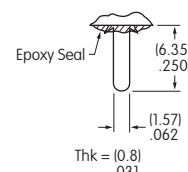

**03** .250" (6.35mm) Straight PC

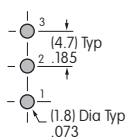
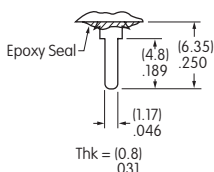

Single Pole

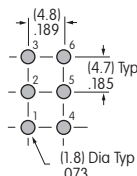

Double Pole

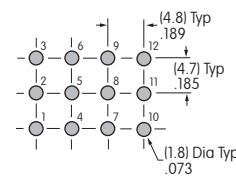

Four Pole

**05** .425" (10.8mm) Wirewrap or Extended PC

**06** .750" (19.05mm) Wirewrap or Extended PC

**07** .964" (24.5mm) Wirewrap or Extended PC

**08** 1.062" (27.0mm) Wirewrap or Extended PC

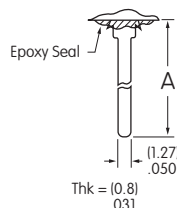

If using as extended PC terminal, refer to the above footprints.

Dimension A = terminal lengths as shown beside the terminal codes at the left.

## CAPS & CAP COLORS

**B** AT078  
.315" (8.0mm)  
Diameter Screw-on Cap

**C** AT079  
.394" (10.0mm)  
Diameter Screw-on Cap

**D** AT414  
.520" (13.2mm)  
Diameter Screw-on Cap

**E** AT412  
.748" (19.0mm)  
Diameter Screw-on Cap

Material:  
Polystyrene  
Finish:  
Glossy



Material:  
Polystyrene  
Finish:  
Glossy



Material:  
PBT  
Finish:  
Glossy



Material:  
Polystyrene  
Finish:  
Glossy



Colors Available:  
A B C E F G H

Colors Available:  
A B C E F G H

Colors Available:  
A B C D E F G H

Colors Available:  
A B C F

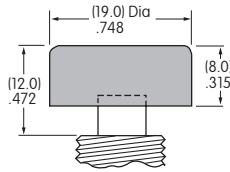
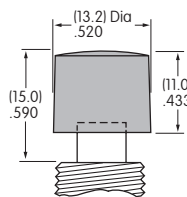
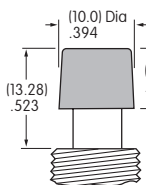
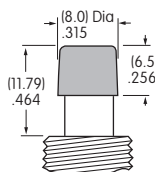

Cap Color Codes:

- A** Black
- B** White
- C** Red
- D** Amber
- E** Yellow
- F** Green
- G** Blue
- H** Gray

## TYPICAL SWITCH DIMENSIONS

### Solder Lug

### Single Pole

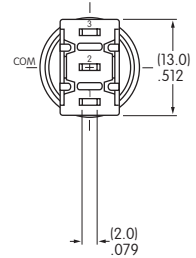
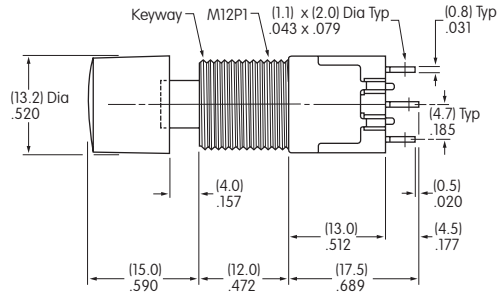
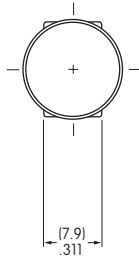

**MB2011SB1W01-DA**

### Solder Lug

### Double Pole

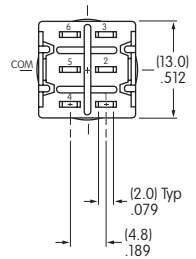
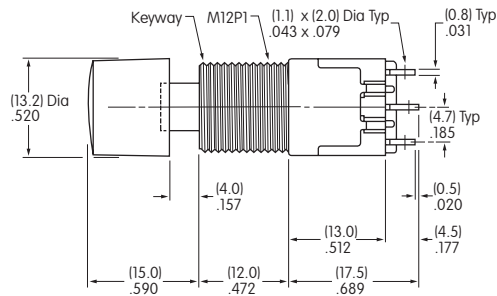
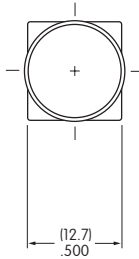

**MB2061SB1W01-DA**

### Solder Lug

### Four Pole

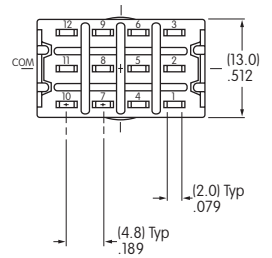
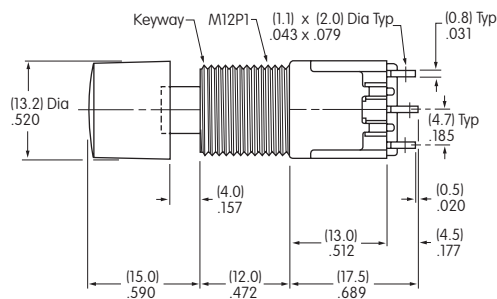
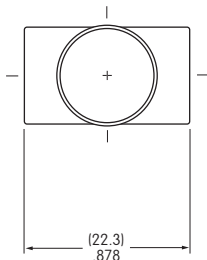

**MB2181SB1W01-DA**

Toggle

Rockers

Pushbuttons

Illuminated PB

Keylocks

Rotaries

Slides

Tactiles

Tilt

Touch

Indicators

Accessories

Supplement

## HARDWARE

### Standard Hardware for B1 Bushing

#### AT503M Hex Face Nut

Material:  
Brass with Chrome plating

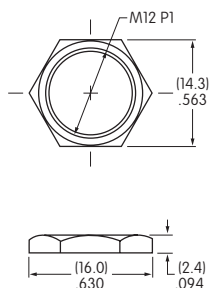

#### AT508 Lockwasher

Material:  
Steel with Zinc/Chromate

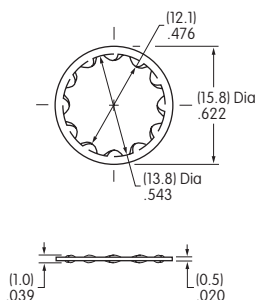

#### AT527M Hex Nut

Material:  
Steel with Nickel plating

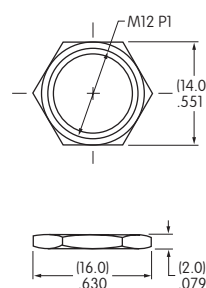

#### AT506M Locking Ring

Material:  
Steel with Zinc/Chromate

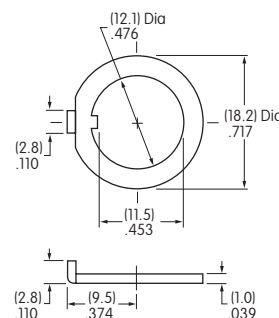

### Standard Hardware for B3 Bushing

#### AT503M Hex Face Nut

Material:  
Brass with Chrome plating

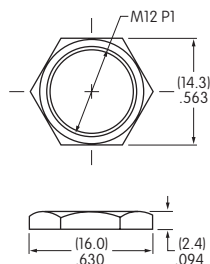

#### AT401P O-ring

Material:  
Nitrile butadiene rubber

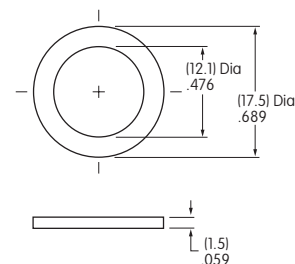

### Optional Splashproof Boot for B1 Bushing

#### AT4043 Splashproof Boot

Material: Silicone Rubber  
Operating Life: 10,000 for momentary  
30,000 for alternate action

When using a splashproof boot, no cap is required.

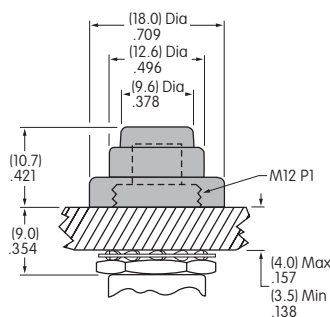

## CUSTOM ASSEMBLY ORDERING EXAMPLE

The MB2000 pushbutton series offers flexibility to accommodate a variety of applications. Using a basic large bushing model, different accessories can be assembled onto the switch to achieve the mounting variations shown on the following two pages.

- These switches have:
- 12mm diameter threaded bushing with keyway
  - Silver contacts
  - 6-Amp rating
  - Solder lug terminals

Other 12mm bushing options can be used; see details in preceding Large Bushing Ordering tables.

**MB2011**

**SB1W01**

**4**

**C**

**A**

Poles & Circuits			
<b>2011</b>	SPDT	ON	(ON)
<b>2065</b>	SPDT	ON	ON
<b>2061</b>	DPDT	ON	(ON)
<b>2085</b>	DPDT	ON	ON
4-pole available			
( ) = Momentary			

Mounter Shapes For Shroud	
<b>4</b>	Round
<b>5</b>	Rectangular

Cap Colors For Shroud	
<b>A</b>	Black
<b>B</b>	White
<b>C</b>	Red
<b>F</b>	Green
<b>G</b>	Blue
<b>H</b>	Gray

Mounter Colors For Shroud	
<b>A</b>	Black
<b>B</b>	White
<b>H</b>	Gray

Cap Colors For Snap-In	
<b>A</b>	Black
<b>B</b>	White
<b>C</b>	Red
<b>F</b>	Green



**Round Shroud**  
**MB2011SB1W01-4C-A**



**Rectangular Shroud**  
**MB2011SB1W01-5C-A**

See custom assemblies on following pages.

MOUNTER SHAPES FOR SHROUDS

**4** AT455 Round

Material: Polycarbonate  
Colors: A B H



**5** AT453 Rectangular

Material: Polycarbonate  
Colors: A B H



CAPS & CAP COLORS FOR SHROUDS

AT454 Round  
Insert Cap

Material: Polycarbonate  
Colors: A B C F G H



AT452 Rectangular  
Insert Cap

Material: Polycarbonate  
Colors: A B C F G H



AT080 Screw Adaptor for Insert Caps

Material: Brass



Color Codes:

- A** Black
- B** White
- C** Red
- F** Green
- G** Blue
- H** Gray

Toggle

Rockers

**C** Pushbuttons

Illuminated PB

Programmable

Key locks

Rotaries

Slides

Tactiles

Tilt

Touch

Indicators

Accessories

Supplement

# Series MB2000

## Large Bushing Miniature Pushbuttons

### CUSTOM ASSEMBLY WITH ROUND SHROUD



**MB2011SB1W01-4C-A**

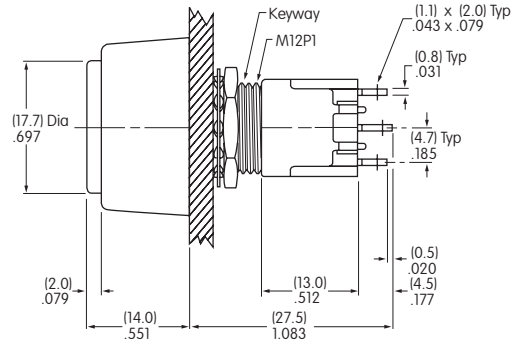
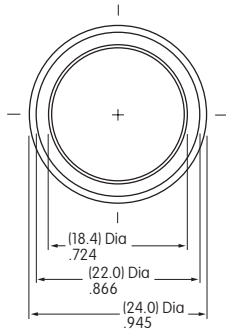

#### Single Pole

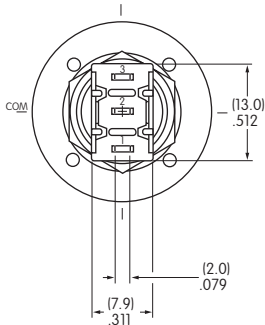

#### Double Pole

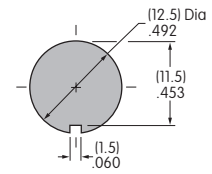
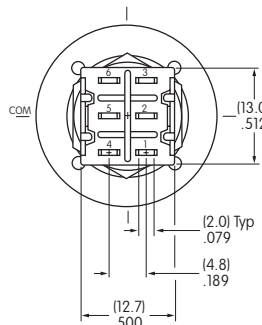

Effective Panel Thickness:  
.217" (5.5mm) maximum

### CUSTOM ASSEMBLY WITH RECTANGULAR SHROUD



**MB2011SB1W01-5C-A**

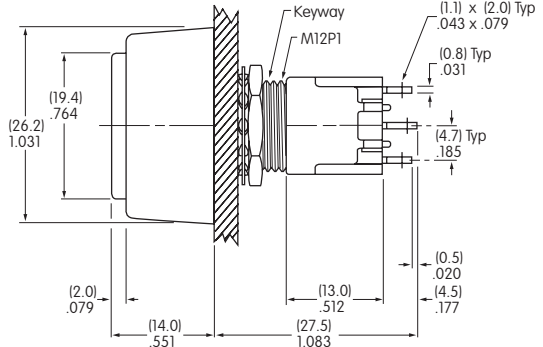
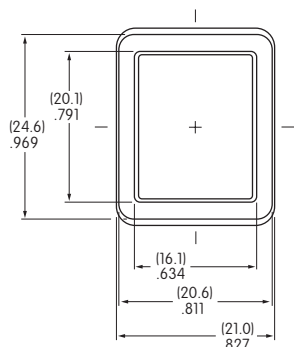

#### Single Pole

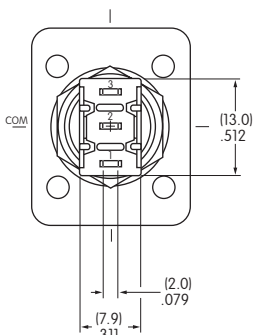

#### Double Pole

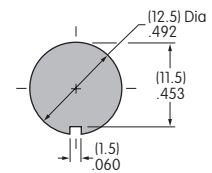
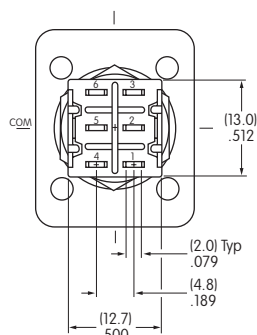

Effective Panel Thickness:  
.217" (5.5mm) maximum



# General Specifications

## Electrical Capacity (Resistive Load)

<b>Power Level (silver):</b>	3A @ 125V AC
<b>Logic Level (gold):</b>	0.4VA maximum @ 28V AC/DC maximum (Applicable Range 0.1mA ~ 0.1A @ 20mV ~ 28V)
<b>Logic/Power Level:</b>	Combines silver & gold ratings
<b>(gold over silver)</b>	Note: Find additional explanation of dual rating & operating range in Supplement section.

## Other Ratings

<b>Contact Resistance:</b>	20 milliohms maximum for silver; 30 milliohms maximum for gold
<b>Insulation Resistance:</b>	1,000 megohms minimum @ 500V DC
<b>Dielectric Strength:</b>	1,000V AC minimum between contacts for 1 minute minimum; 1,500V AC minimum between contacts & case for 1 minute minimum
<b>Mechanical Life:</b>	200,000 operations minimum
<b>Electrical Life:</b>	25,000 operations minimum for silver; 100,000 operations minimum for gold
<b>Nominal Operating Force:</b>	Single pole 2.45N; double pole 3.92N
<b>Travel</b>	Pretravel .024" (0.6mm); Overtravel .016" (0.4mm); Total Travel .039" (1.0mm)

## Materials & Finishes

<b>Plunger:</b>	Brass with nickel plating
<b>Bushing:</b>	Brass with nickel plating
<b>Frame:</b>	Stainless steel
<b>Case:</b>	Polybutylene terephthalate (PBT) (UL94V-0)
<b>Base:</b>	Diallyl phthalate resin (UL94V-0)
<b>Movable Contactor:</b>	Phosphor bronze with silver or gold plating
<b>Movable Contacts:</b>	Silver alloy (code W); copper with gold plating (code G); or silver alloy with gold plating (code A)
<b>Stationary Contacts:</b>	Silver alloy with silver plating (code W); copper or brass with gold plating (code G); or silver with gold plating (code A)
<b>Terminals:</b>	Copper or brass with silver plating; copper or brass with gold plating

## Environmental Data

<b>Operating Temp Range:</b>	-30°C through +85°C (-22°F through +185°F)
<b>Humidity:</b>	90 ~ 95% humidity for 96 hours @ 40°C (104°F)
<b>Vibration:</b>	10 ~ 55Hz with peak-to-peak amplitude of 1.5mm traversing the frequency range & returning in 1 minute; 3 right angled directions for 2 hours
<b>Shock:</b>	50G (490m/s <sup>2</sup> ) acceleration (tested in 6 right angled directions, with 3 shocks in each direction)

## Installation

<b>Mounting Torque:</b>	1.5Nm (13.0 lb•in) for double nut; 0.7Nm (6.0 lb•in) for single nut
<b>Cap Installation Force:</b>	80.0N (18.0 lbf) maximum downward force on actuator
<b>Soldering:</b>	Wave Soldering (PC version): See Profile B in Supplement section. Manual Soldering: See Profile B in Supplement section.
<b>Cleaning:</b>	These devices are not process sealed. Hand clean locally using alcohol based solution. See Cleaning Specifications in Supplement section.

## Standards & Certifications

<b>Flammability Standards:</b>	UL94V-0 case & base
<b>UL:</b>	<b>File No. E44145 - Recognized only when ordered with marking on switch.</b> Add "/U" or "/CUL" before dash in part number to order UL recognized switch. All single and double pole models recognized at 3A @ 125V AC or 0.4VA max. @ 28V DC max.
<b>CSA:</b>	<b>File No. 023535_0_000 - Certified only when ordered with marking on switch.</b> Add "/C" before dash in part number to order CSA certified switch. Single pole models with PC, solder lug, or Wirewrap terminals & double pole with PC or Wirewrap terminals certified at 3A @ 125V AC or 0.4VA @ 28V maximum.



# Distinctive Characteristics

Snap-acting mechanism gives smooth actuation, short stroke, light touch, and audible feedback. This mechanism also provides long mechanical life.

High torque bushing construction prevents rotation or separation from frame during installation.

Antijamming design protects contacts from damage due to excessive downward force on the actuator.

Compatible companions with M series toggles. Body, bushing, and footprint dimensions ideal for mounting MB2400 pushbuttons and M toggles next to one another.

Stainless steel frame resists corrosion.

Longer center solder lug terminal simplifies wiring and soldering.

Silver contacts of specially composed alloy for hardness.

Epoxy sealed terminals prevent entry of solder flux and other contaminants.

Prominent external insulating barriers increase insulation resistance and dielectric strength.

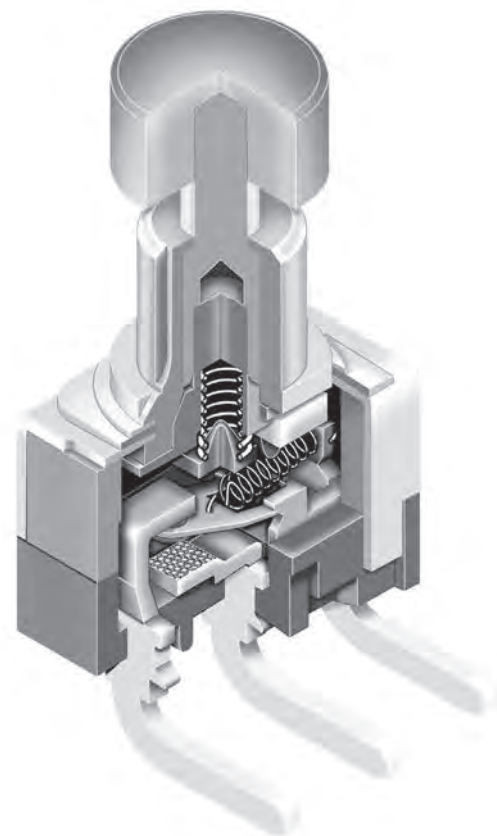

Actual Size

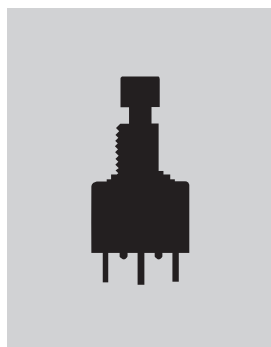

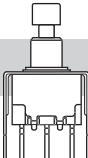
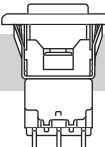
	Bushing Mount	Page C98
	Bracket PC Mount	Page C102
	Snap-in Mount	Page C108

Toggles

Rockers

**C** Pushbuttons

Illuminated PB

Programmable

Key locks

Rotaries

Slides

Tactiles

Tilt

Touch

Indicators

Accessories

Supplement

### TYPICAL SWITCH ORDERING EXAMPLE

**MB24**

**11**

**E1**

**W**

**01**

**F**

**A**

#### Poles & Circuits

<b>11</b>	SPDT	ON	(ON)
<b>61</b>	DPDT	ON	(ON)
( ) = Momentary			

#### Contact Materials & Ratings

<b>W</b>	Silver Rated 3A @ 125V AC
<b>G</b>	Gold Rated 0.4VA max @ 28V AC/DC max
<b>A</b>	Gold over Silver Rated 3A @ 125V AC & 0.4VA max @ 28V AC/DC max

#### Caps

<b>F</b>	.201" (5.1mm) Diameter
<b>H</b>	.295" (7.5mm) Diameter

#### Bushings

<b>E1</b>	.285" (7.24mm) Threaded with D Flat
<b>E2</b>	.285" (7.24mm) Smooth with D Flat
<b>A1</b>	.280" (7.1mm) Threaded with Keyway
<b>A2</b>	.280" (7.1mm) Smooth with Keyway
<b>S1</b>	.350" (8.9mm) Threaded with Keyway
<b>S2</b>	.350" (8.9mm) Smooth with Keyway

#### Terminals

<b>01</b>	Solder Lug
<b>03</b>	.250" (6.35mm) Straight PC
<b>05</b>	.425" (10.8mm) Wirewrap
<b>06</b>	.750" (19.05mm) Wirewrap
<b>07</b>	.964" (24.5mm) Wirewrap

#### Cap Colors

<b>A</b>	Black
<b>B</b>	White
<b>C</b>	Red

### IMPORTANT:



Switches are supplied without UL, cULus & CSA marking unless specified.  
**UL, cULus & CSA recognized only when ordered with marking on the switch.**  
 Specific models, ratings, & ordering instructions are noted on the General Specifications page.

### DESCRIPTION FOR TYPICAL ORDERING EXAMPLE

**MB2411E1W01-FA**

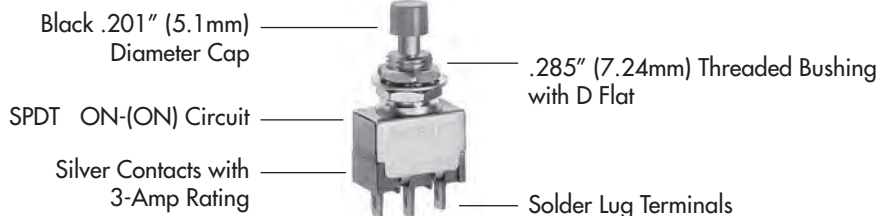

Toggles  
 Rockers  
 Pushbuttons  
 Illuminated PB  
 Programmable  
 Keylocks  
 Rotaries  
 Slides  
 Tactiles  
 Tilt  
 Touch  
 Indicators  
 Accessories  
 Supplement

## POLES & CIRCUITS

Pole	Model	Plunger Position ( ) = Momentary		Connected Terminals		Throw & Switch Schematics
		Normal	Down	Normal	Down	
						Note: Terminal numbers are not actually on the switch.
SP	MB2411	ON	(ON)	1-3	1-2	SPDT
DP	MB2461	ON	(ON)	1-3 4-6	1-2 4-5	DPDT

## BUSHINGS

Note: Plunger selection is not required for MB2400 pushbuttons. The plunger can be used with or without a cap.

**E1** .285" (7.24mm)  
Threaded with D Flat

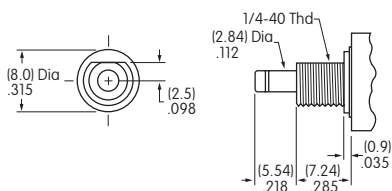

Maximum Panel Thickness with Standard Hardware: .068" (1.74mm)

**A1** .280" (7.1mm)  
Threaded with Keyway

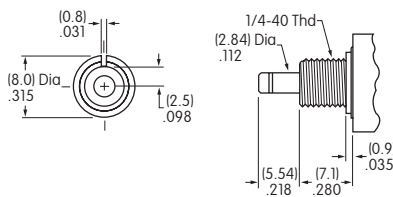

Maximum Panel Thickness with Standard Hardware: .068" (1.74mm)

**S1** .350" (8.9mm)  
Threaded with Keyway

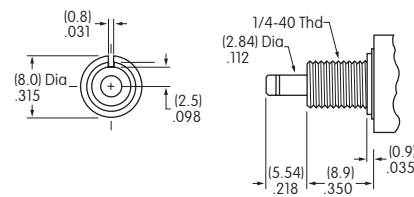

Maximum Panel Thickness with Standard Hardware: .134" (3.40mm)

**E2** .285" (7.24mm)  
Smooth with D Flat

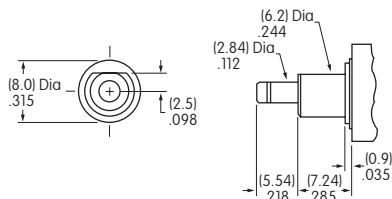

**A2** .280" (7.1mm)  
Smooth with Keyway

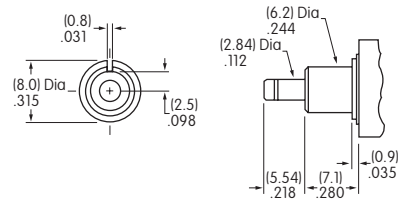

**S2** .350" (8.9mm)  
Smooth with Keyway

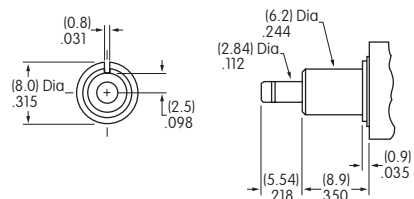

### Panel Cutouts

For A1, A2, S1, or S2 Bushing with Keyway

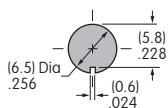

For E1 or E2 Bushing with D Flat

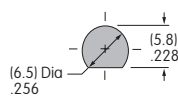

With Optional Locking Ring

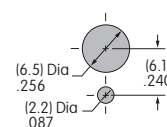

Standard hardware includes 2 hex nuts & 1 lockwasher.  
Hardware is illustrated following the Typical Switch Dimension drawings.

## CONTACT MATERIALS & RATINGS

<b>W</b>	Silver over Silver	Power Level	3A @ 125V AC
----------	--------------------	-------------	--------------

<b>G</b>	Gold over Brass or Copper	Logic Level	0.4VA maximum @ 28V AC/DC maximum
----------	---------------------------	-------------	-----------------------------------

Note: Complete explanation of operating range in Supplement section.

<b>A</b>	Gold over Silver	Power Level or Logic Level	3A @ 125V AC or 0.4VA maximum @ 28V AC/DC maximum
----------	------------------	----------------------------	---

Note: This dual rated option is suitable when two or more identical switches are used in logic and in power circuits within the same application. See Supplement section for complete explanation of dual rating and operating range.

## TERMINALS

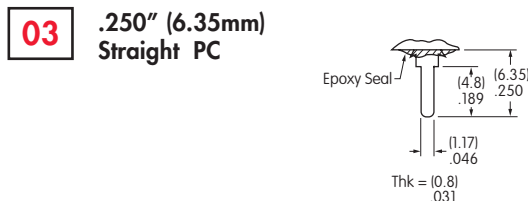
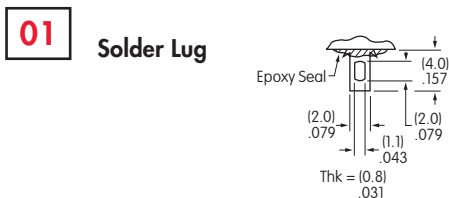

### Wirewrap or Extended PC



Refer to footprints if using as extended PC terminal.

Dimension A = terminal lengths as shown beside the code boxes at left.

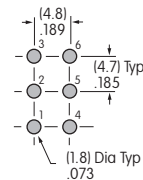
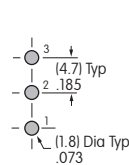

Single Pole

Double Pole

## CAPS & CAP COLORS

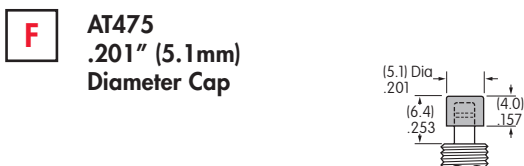

Material: Polyamide  
Finish: Glossy

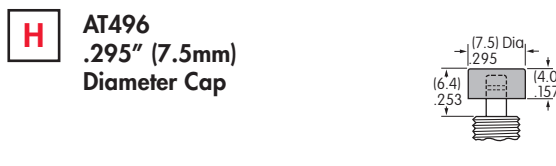

Material: Polyamide  
Finish: Glossy



Cap Colors Available:

**A** Black

**B** White

**C** Red

## TYPICAL SWITCH DIMENSIONS

### Single Pole

### Solder Lug

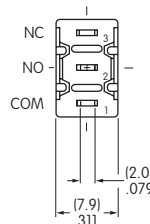
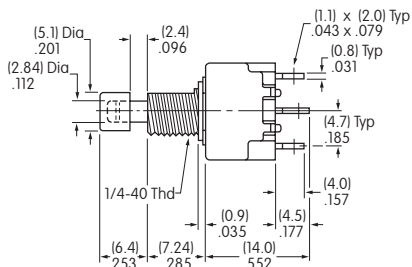
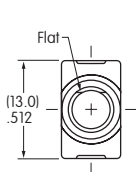

**MB2411E1W01-FA**

### Double Pole

### Solder Lug

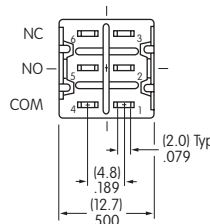
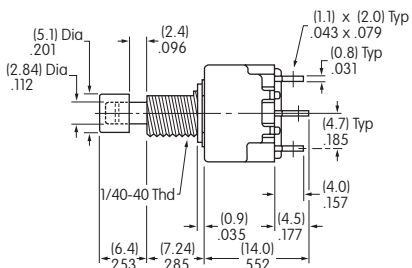
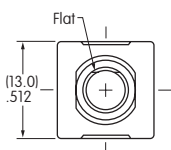

**MB2461E1W01-FA**

## HARDWARE

### Standard Hardware

#### AT513H Inch Threaded Hexagon Nut

2 included with each switch

Material:  
Brass with Nickel Plating

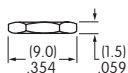
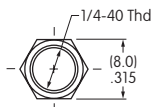

#### AT509 Lockwasher

1 included with each switch

Material:  
Steel with Zinc/Chromate

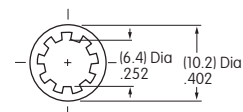

### Optional Hardware

#### AT507H Locking Ring for A1 or S1 Bushing

Material:  
Steel with Zinc/Chromate

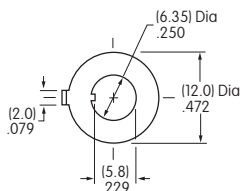

#### AT515 Locking Ring for E1 Bushing

Material:  
Steel with Zinc/Chromate

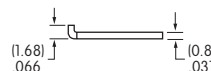
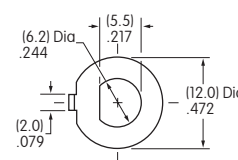

### TYPICAL SWITCH ORDERING EXAMPLE

**MB24**

**11**

**A2**

**G**

**40**

— **F**

**A**

#### Poles & Circuits

<b>11</b>	SPDT	ON	(ON)
<b>61</b>	DPDT	ON	(ON)
( ) = Momentary			

#### Bushings

<b>A2</b>	.280" (7.1mm) Smooth with Keyway
<b>A1</b>	.280" (7.1mm) Threaded with Keyway
<b>E2</b>	.285" (7.24mm) Smooth with D Flat
<b>E1</b>	.285" (7.24mm) Threaded with D Flat
<b>S2</b>	.350" (8.9mm) Smooth with Keyway
<b>S1</b>	.350" (8.9mm) Threaded with Keyway

#### Contact Materials & Ratings

<b>W</b>	Silver Rated 3A @ 125V AC
<b>G</b>	Gold Rated 0.4VA max @ 28V AC/DC max
<b>A</b>	Gold over Silver Rated 3A @ 125V AC & 0.4VA max @ 28V AC/DC max

#### Caps

<b>F</b>	.201" (5.1mm) Dia.
<b>H</b>	.295" (7.5mm) Dia.

#### Cap Colors

<b>A</b>	Black
<b>B</b>	White
<b>C</b>	Red

#### Terminals

##### With Bracket

<b>13</b>	.250" (6.35mm) Straight PC with .465" (11.8mm) Bracket
<b>15</b>	.425" (10.8mm) Straight PC with .630" (16.0mm) Bracket
<b>17</b>	.964" (24.5mm) Straight PC with 1.150" (29.2mm) Bracket

##### With Reinforced Bracket

<b>23</b>	.250" (6.35mm) Straight PC with .465" (11.8mm) Bracket
<b>25</b>	.425" (10.8mm) Straight PC with .630" (16.0mm) Bracket
<b>26</b>	.750" (19.05mm) Straight PC with .953" (24.2mm) Bracket

##### With Terminal Support

<b>30</b>	Right Angle PC
<b>40</b>	Vertical PC

### IMPORTANT:



Switches are supplied without UL, cULus & CSA marking unless specified.  
**UL, cULus & CSA recognized only when ordered with marking on the switch.**  
 Specific models, ratings, & ordering instructions are noted on the General Specifications page.

### DESCRIPTION FOR TYPICAL ORDERING EXAMPLE

**MB2411A2G40-FA**

.280" (7.1mm) Smooth Bushing  
with Keyway  
Black .201" (5.1mm)  
Diameter Cap



SPDT  
ON-(ON) Circuit  
Vertical PC Terminals  
Gold Contacts with  
0.4VA Rating

## POLES & CIRCUITS

Pole	Model	Plunger Position ( ) = Momentary		Connected Terminals		Throw & Switch Schematics
		Normal	Down	Normal	Down	
						Note: Terminal numbers are not actually on the switch.
SP	MB2411	ON	(ON)	1-3	1-2	SPDT 
DP	MB2461	ON	(ON)	1-3 4-6	1-2 4-5	DPDT 

## BUSHINGS

Note: Plunger selection is not required for MB2400 pushbuttons.  
The plunger can be used with or without a cap.

**A2** .280" (7.1mm)  
Smooth with Keyway

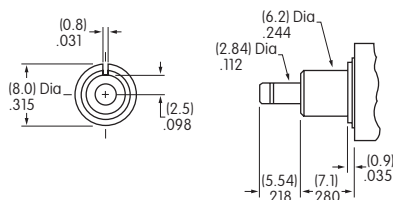

**E2** .285" (7.24mm)  
Smooth with D Flat

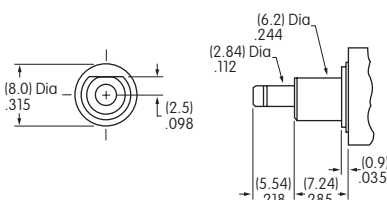

**S2** .350" (8.9mm)  
Smooth with Keyway

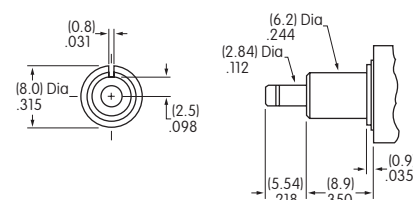

**A1** .280" (7.1mm)  
Threaded with Keyway

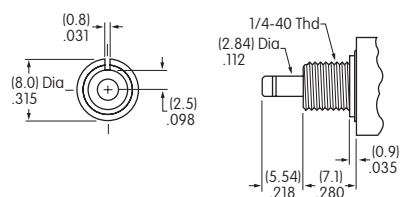

**E1** .285" (7.24mm)  
Threaded with D Flat

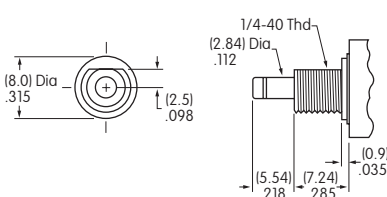

**S1** .350" (8.9mm)  
Threaded with Keyway

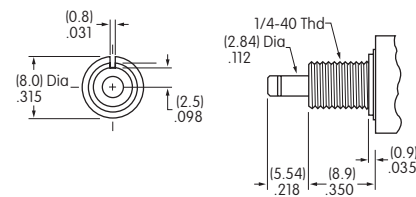

Maximum Panel Thickness with  
Standard Hardware: .068" (1.74mm)

Maximum Panel Thickness with  
Standard Hardware: .068" (1.74mm)

Maximum Panel Thickness with  
Standard Hardware: .134" (3.40mm)

### Panel Cutouts

For A1, A2, S1, or S2 Bushing  
with Keyway

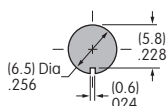

For E1 or E2 Bushing  
with D Flat

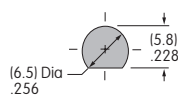

With  
Optional Locking Ring

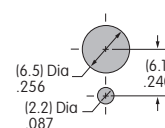

Standard hardware includes 2 hex nuts & 1 lockwasher.  
Hardware is illustrated following the Typical Switch Dimension drawings.



### CONTACT MATERIALS & RATINGS

<b>W</b>	Silver over Silver	Power Level	3A @ 125V AC
<b>G</b>	Gold over Brass or Copper	Logic Level	0.4VA maximum @ 28V AC/DC maximum
Note: Complete explanation of operating range in Supplement section.			
<b>A</b>	Gold over Silver	Power Level or Logic Level	3A @ 125V AC or 0.4VA maximum @ 28V AC/DC maximum
Note: This dual rated option is suitable when two or more identical switches are used in logic and in power circuits within the same application. See Supplement section for complete explanation of dual rating and operating range.			

### TERMINALS

#### Straight PC Mount with Bracket

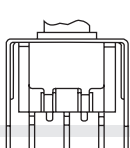
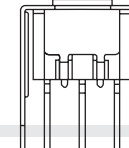
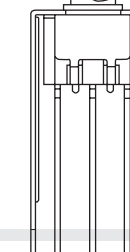
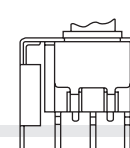
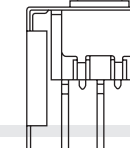
#### Straight PC Mount with Reinforced Bracket

<b>13</b>	<b>15</b>	<b>17</b>	<b>23</b>	<b>25</b>	<b>26</b>
.250" (6.35mm) Terminal with .465" (11.8mm) Bracket	.425" (10.8mm) Terminal with .630" (16.0mm) Bracket	.964" (24.5mm) Terminal with 1.150" (29.2mm) Bracket	.250" (6.35mm) Terminal with .465" (11.8mm) Bracket	.425" (10.8mm) Terminal with .630" (16.0mm) Bracket	.750" (19.05mm) Terminal with .953" (24.2mm) Bracket
					

**30** Right Angle PC

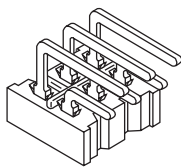

**40** Vertical PC

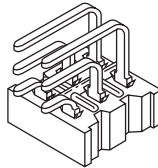

PCB footprints are on the following Typical Switch Dimension pages.

### CAPS & CAP COLORS

**F** AT475  
.201" (5.1mm)  
Diameter Cap

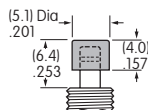

Material: Polyamide  
Finish: Glossy



**H** AT496  
.295" (7.5mm)  
Diameter Cap

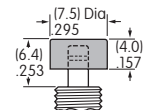

Material: Polyamide  
Finish: Glossy



Cap Colors Available:

**A** Black

**B** White

**C** Red



## TYPICAL SWITCH DIMENSIONS

### Straight PC • Bracket

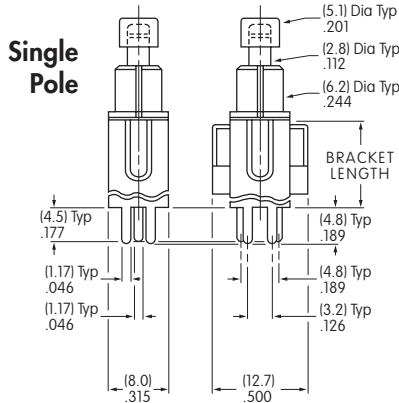
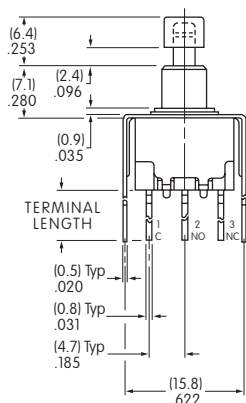

Double Pole



**MB2411A2G13-FA**

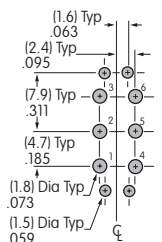
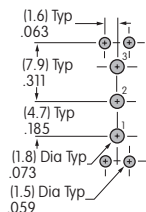

Terminal Code:	Terminal Length:	Bracket Length:
<b>13</b>	.250 (6.35mm)	.465 (11.8mm)
<b>15</b>	.425 (10.8mm)	.630 (16.0mm)
<b>17</b>	.964 (24.5mm)	1.150 (29.2mm)

### Straight PC • Reinforced Bracket

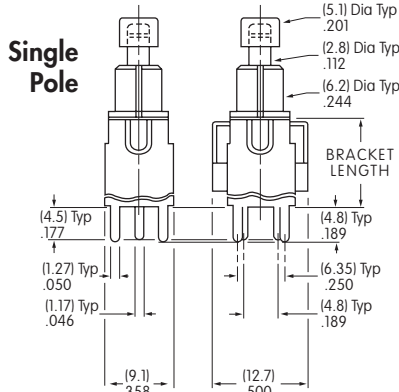
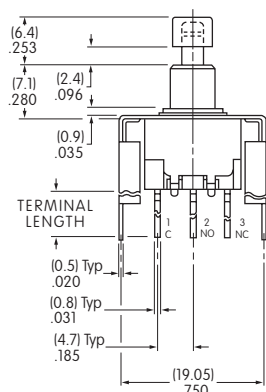

Double Pole



**MB2411A2G23-FA**

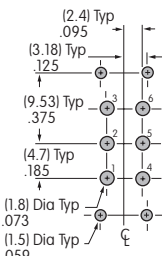
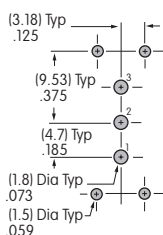

Terminal Code:	Terminal Length:	Bracket Length:
<b>23</b>	.250 (6.35mm)	.465 (11.8mm)
<b>25</b>	.425 (10.8mm)	.630 (16.0mm)
<b>26</b>	.750 (19.05mm)	.953 (24.2mm)

## TYPICAL SWITCH DIMENSIONS

### Right Angle PC

### Single Pole

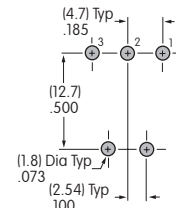
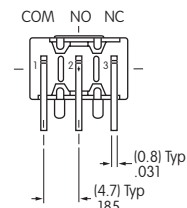
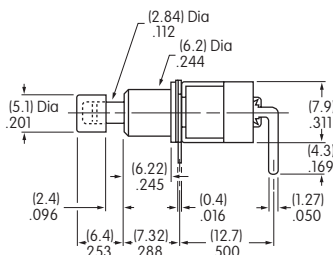
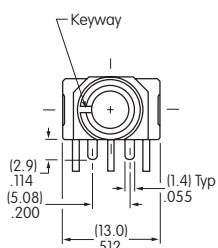

**MB2411A2G30-FA**

### Right Angle PC

### Double Pole

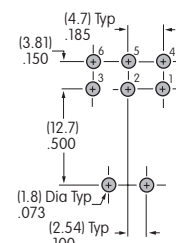
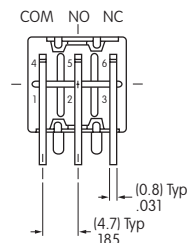
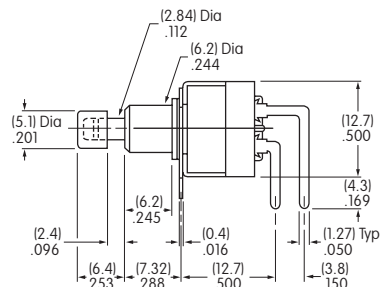
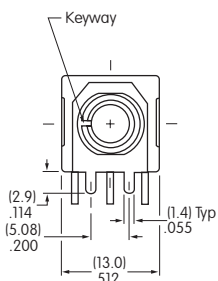

**MB2461A2G30-FA**

### Vertical PC

### Single Pole

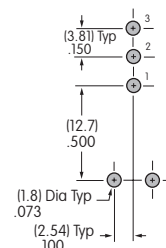
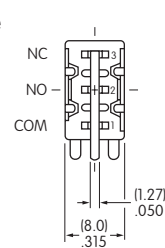
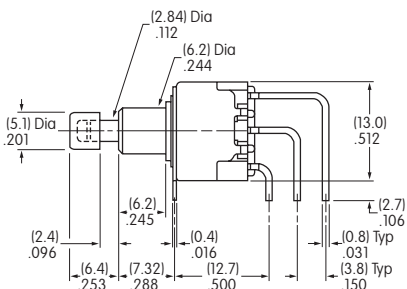
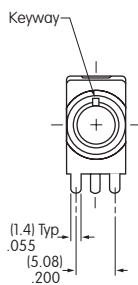

**MB2411A2G40-FA**

### Double Pole

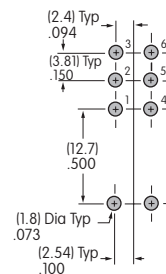
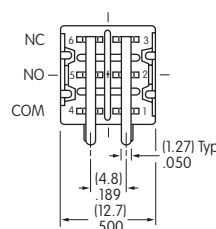

## HARDWARE

### Standard Hardware

#### AT513H Inch Threaded Hexagon Nut

2 included with each switch

Material:  
Brass with Nickel Plating

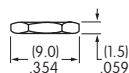
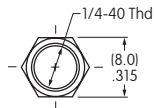

#### AT509 Lockwasher

1 included with each switch

Material:  
Steel with Zinc/Chromate

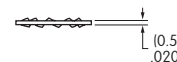
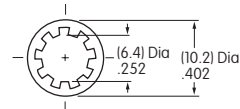

### Optional Hardware

#### AT507H Locking Ring for A1 or S1 Bushing

Material:  
Steel with Zinc/Chromate

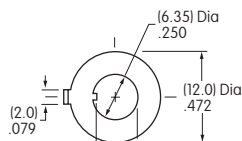

#### AT515 Locking Ring for E1 Bushing

Material:  
Steel with Zinc/Chromate

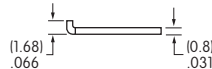
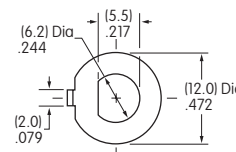

Toggle

Rockers

Pushbuttons

ILLUMINATED PB

Programmable

Key locks

Rotaries

Slides

Tactiles

Tilt

Touch

Indicators

Accessories

Supplement

**MB24**

**11**

**J**

**W**

**01**

**C**

#### Poles & Circuits

11	SPDT	ON	(ON)
61	DPDT	ON	(ON)
( ) = Momentary			

#### Contact Materials & Ratings

<b>W</b>	Silver Rated 3A @ 125V AC
<b>G</b>	Gold Rated 0.4VA max @ 28V AC/DC max
<b>A</b>	Gold over Silver Rated 3A @ 125V AC & 0.4VA max @ 28V AC/DC max

#### Cap & Cap Colors

<b>A</b>	Black
<b>B</b>	White
<b>C</b>	Red
<b>E</b>	Yellow
<b>F</b>	Green
<b>G</b>	Blue
<b>H</b>	Gray

#### Mounting Frame

<b>J</b>	Snap-in Frame
----------	---------------

#### Terminals

<b>01</b>	Solder Lug
<b>03</b>	.250" (6.35mm) Straight PC
<b>05</b>	.425" (10.8mm) Wirewrap
<b>06</b>	.750" (19.05mm) Wirewrap
<b>07</b>	.964" (24.5mm) Wirewrap

#### IMPORTANT:



Switches are supplied without UL, cULus & CSA marking unless specified.  
**UL, cULus & CSA recognized only when ordered with marking on the switch.**  
 Specific models, ratings, & ordering instructions are noted on the General Specifications page.

#### DESCRIPTION FOR TYPICAL ORDERING EXAMPLE

**MB2411JW01-C**

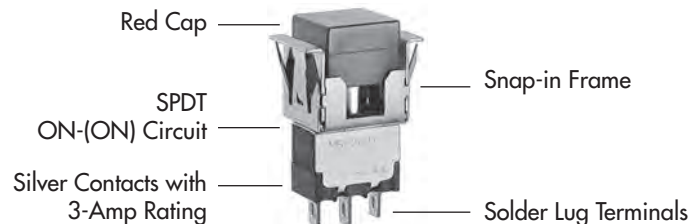

## ORDERING EXAMPLE

3	A	—	C	F	
<b>Optional Bezels</b>		<b>Bezel Colors</b>		<b>LED Colors</b>	
1	Bezel without LEDs	A	Black	<b>1 LED</b>	
*2	Bezel with 1 Round LED	B	White	C	Red
*3	Bezel with 2 Round LEDs	C	Red	F	Green
*4	Bezel with 2 Rectangular LEDs	E	Yellow	<b>2 LEDs</b>	
* Available in Black color only		F	Green	<b>Top LED</b>	
		G	Blue	C	Red
		H	Gray	E	Yellow
				F	Green
				<b>Bottom LED</b>	
				C	Red
				E	Yellow
				F	Green

### DESCRIPTION FOR TYPICAL ORDERING EXAMPLE

**MB2411JW01-C-3A-CF**



Toggle

Rockers

Pushbuttons

Illuminated PB

Programmable

Keylocks

Rotaries

Slides

Tactiles

Tilt

Touch

Indicators

Accessories

Supplement

## POLES & CIRCUITS

		Plunger Position ( ) = Momentary		Connected Terminals		Throw & Switch Schematics
Pole	Model	Normal	Down	Normal	Down	
SP	MB2411	ON	(ON)	1-3	1-2	SPDT 
DP	MB2461	ON	(ON)	1-3 4-6	1-2 4-5	DPDT 

## MOUNTING FRAME

**J**

### Snap-in Frame

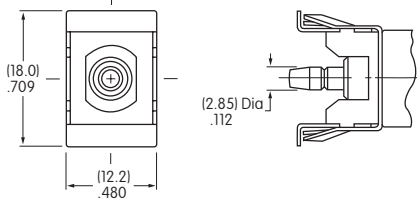

Panel Cutout  
for Single Pole  
without Bezel

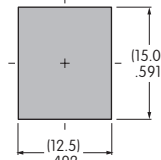

Panel Cutout  
for Double Pole  
without Bezel

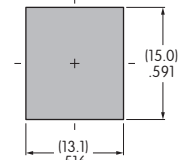

Panel Thickness without Bezel: .039" ~ .157" (1.0mm ~ 4.0mm)  
 Panel Thickness with Bezel: .039" ~ .126" (1.0mm ~ 3.2mm)

## CONTACT MATERIALS & RATINGS

**W**

Silver over Silver

Power Level

3A @ 125V AC

**G**

Gold over Brass or Copper

Logic Level

0.4VA maximum @ 28V AC/DC maximum

Note: Complete explanation of operating range in Supplement section.

**A**

Gold over Silver

Power Level  
or Logic Level

3A @ 125V AC  
or 0.4VA maximum @ 28V AC/DC maximum

Note: This dual rated option is suitable when two or more identical switches are used in logic and in power circuits within the same application. See Supplement section for complete explanation of dual rating and operating range.

## TERMINALS

**01**

Solder Lug

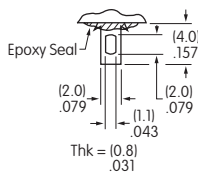

**03**

.250" (6.35mm)  
Straight PC

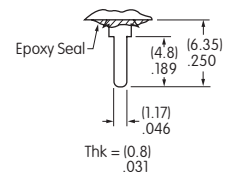

### Wirewrap or Extended PC

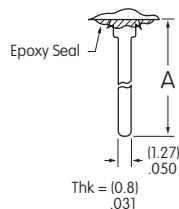

Refer to footprints if using  
as extended PC terminal.

Dimension A = terminal  
lengths as shown beside  
the code boxes at left.

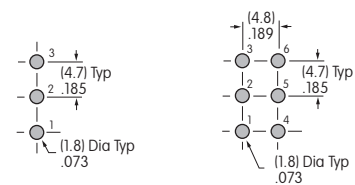

Single Pole

Double Pole

## CAP & CAP COLORS

**AT465**  
**.453" (11.5mm)**  
**Square Cap**

Material: Polycarbonate  
 Finish: Glossy

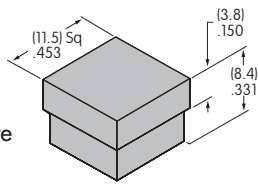

Contact factory for matte finish.

Legend details at end of this section.

- |                |                |               |                 |
|----------------|----------------|---------------|-----------------|
| <b>A</b> Black | <b>B</b> White | <b>C</b> Red  | <b>E</b> Yellow |
| <b>F</b> Green | <b>G</b> Blue  | <b>H</b> Gray |                 |

## OPTIONAL SNAP-IN BEZELS & BEZEL COLORS

**1** **AT207 Bezel**

Material: Polycarbonate  
 Finish: Glossy

Contact factory for matte finish.

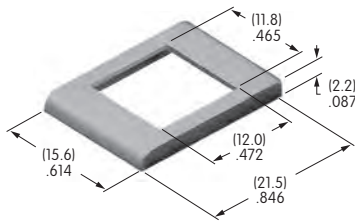

- |                 |                |
|-----------------|----------------|
| <b>A</b> Black  | <b>F</b> Green |
| <b>B</b> White  | <b>G</b> Blue  |
| <b>C</b> Red    | <b>H</b> Gray  |
| <b>E</b> Yellow |                |

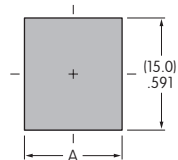

	Single Pole	Double Pole
A	(12.5)mm .492"	(13.1)mm .516"

**2** **AT208 Bezel for AT070 LED**

Material: Polycarbonate  
 Finish: Glossy

Contact factory for matte finish.

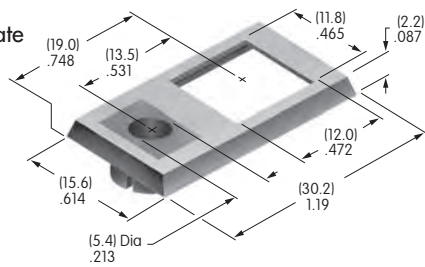

**A** Black  
 LED colors & specifications on next page.

	Single Pole	Double Pole
A	(12.5)mm .492"	(13.1)mm .516"
B	(6.25)mm .246"	(6.55)mm .258"

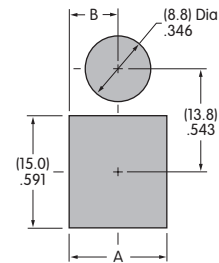

**3** **AT212 Bezel for AT617 LED**

Material: Polycarbonate  
 Finish: Semi-glossy

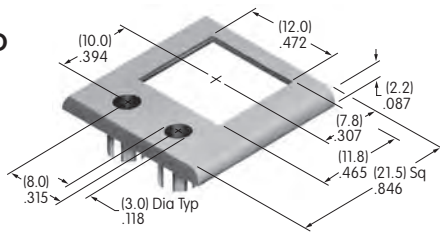

**A** Black  
 LED colors & specifications on next page.

	Single Pole	Double Pole
A	(18.4)mm .724"	(18.7)mm .736"

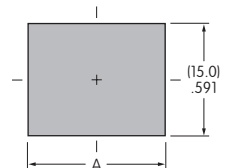

**4** **AT213 Bezel for AT618 LED**

Material: Polycarbonate  
 Finish: Semi-glossy

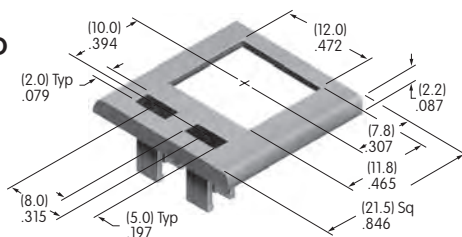

**A** Black  
 LED colors & specifications on next page.

	Single Pole	Double Pole
A	(18.4)mm .724"	(18.7)mm .736"

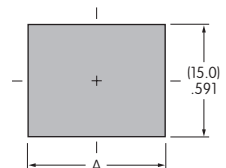

### Bezel Assembly

1. Pry out tab on bezel to a 45° angle.

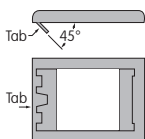

2. Insert switch frame under tab and snap on the bezel.

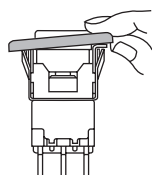

3. Push tab back into place.

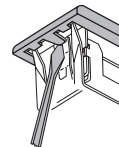

4. Snap assembled bezel and switch into panel.

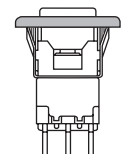

## LED COLORS & SPECIFICATIONS

### Bezel Orientation on Switch

**AT070 LED**  
For Bezel AT208  
with 1 LED

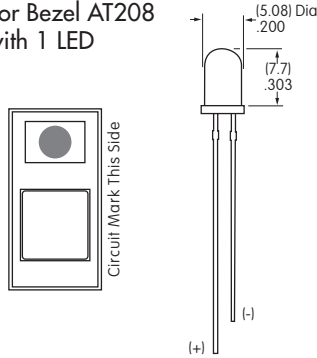

**AT617 LED**  
For Bezel AT212  
with 2 Round LEDs

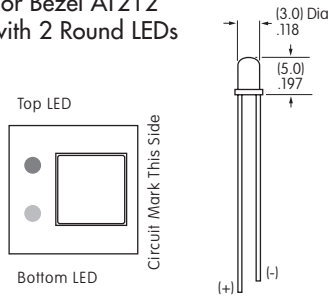

**AT618 LED**  
For Bezel AT213  
with 2 Rectangular LEDs

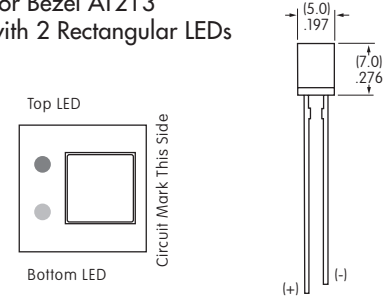

Note: Lead lengths may differ from manufacturing lot to lot. The longer lead is the anode (+).

		AT070		AT617			AT618		
		C	F	C	E	F	C	E	F
	Color	Red	Green	Red	Yellow	Green	Red	Yellow	Green
Maximum Forward Current	$I_{FM}$	25mA	50mA	30mA	30mA	25mA	25mA	30mA	25mA
Typical Forward Current	$I_F$	20mA	30mA	20mA	20mA	20mA	20mA	20mA	20mA
Forward Voltage	$V_F$	2.8V	2.1V	2.0V	2.1V	2.2V	2.25V	2.1V	2.2V
Maximum Reverse Voltage	$V_{RM}$	4V	5V	5V	5V	5V	5V	5V	5V
Current Reduction Rate Above 25°C	$\Delta I_F$	0.33 mA/°C	0.40 mA/°C	0.40 mA/°C	0.40 mA/°C	0.33 mA/°C	0.33 mA/°C	0.40 mA/°C	0.33 mA/°C
Ambient Temperature Range (when used with a bezel)		-10° ~ +70°C		-15° ~ +70°C			-25° ~ +70°C		

The electrical specifications shown are determined at a basic temperature of 25°C. LED circuit is independent of switch operation. LED is colored in OFF state.

If the source voltage is greater than the rated voltage of the LED, a ballast resistor must be connected in series with the LED. The ballast resistor calculation and more lamp detail are shown in the Supplement section.

## TYPICAL SWITCH DIMENSIONS

**Solder Lug**

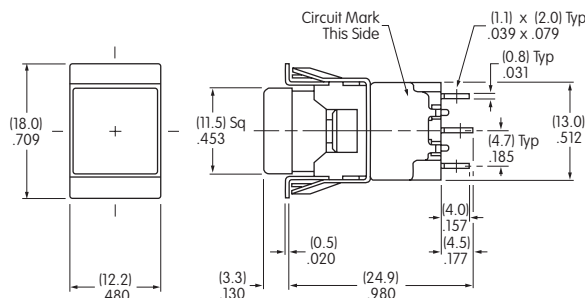

**Single Pole**

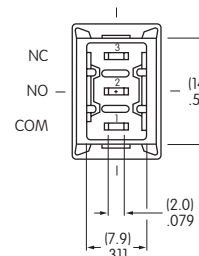

**Double Pole**

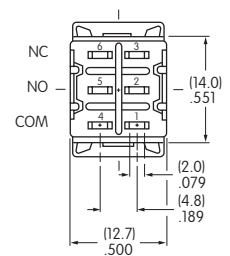

**MB2411JW01-C**



## TYPICAL SWITCH DIMENSIONS

### Single & Double Pole

### Solder Lug • AT207 Bezel

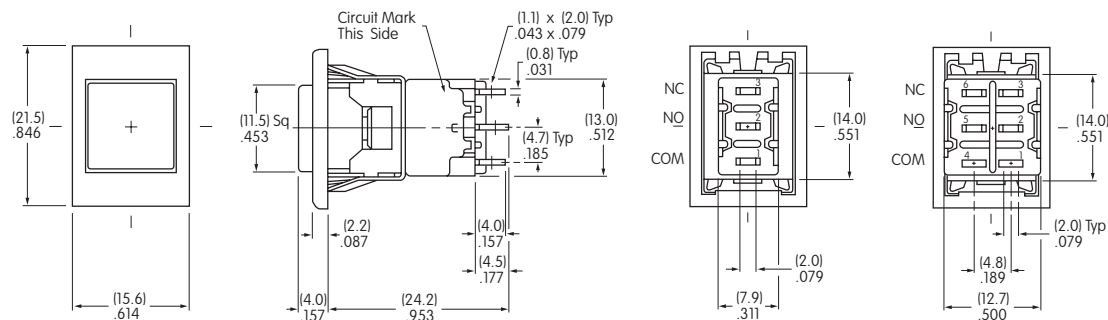

**MB2411JW01-C-1A**

### Single Pole

### Solder Lug • AT208 Bezel

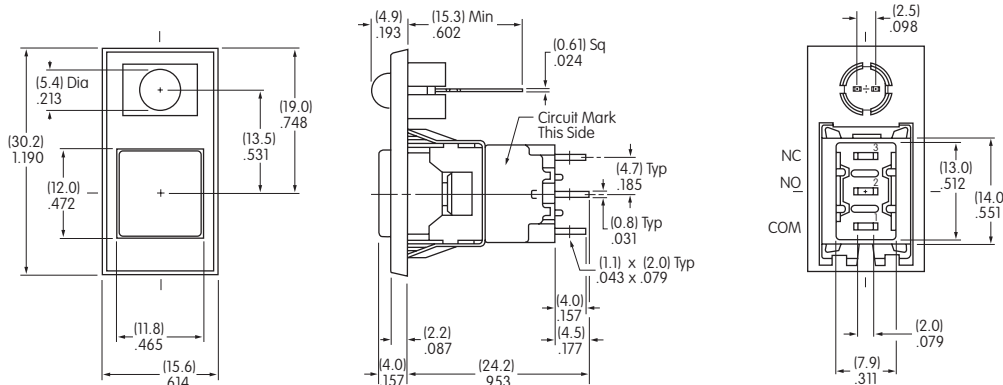

**MB2411JW01-C-2A-C**

### Single Pole

### Solder Lug • AT212 Bezel

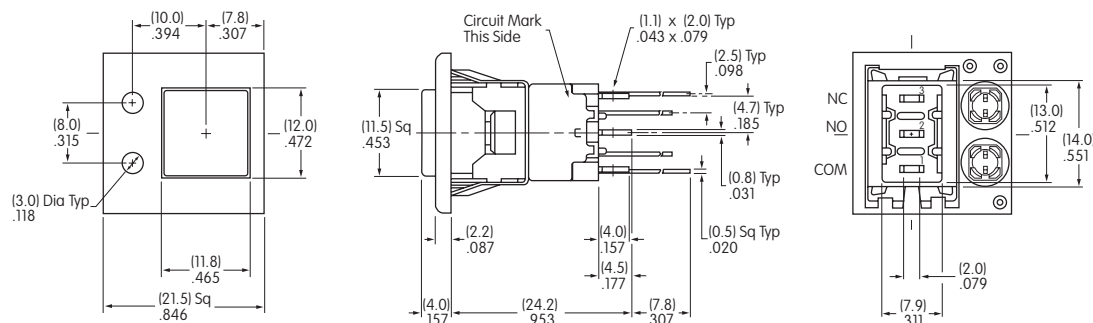

**MB2411JW01-C-3A-CF**

### Double Pole

### Solder Lug • AT213 Bezel

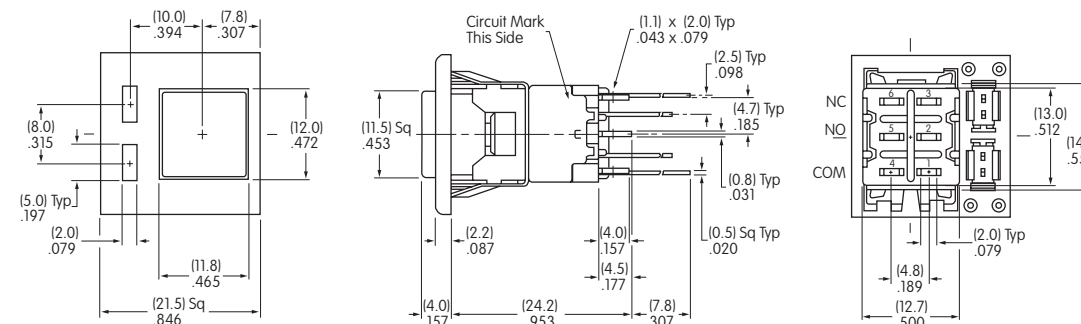

**MB2461JW01-C-4A-CF**

### LEGENDS

NKK Switches can provide custom legends for caps. Contact factory for more information.

#### Suggested Printable Area for Cap

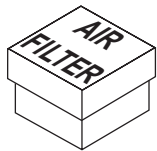

#### Recommended Print Method:

Screen Print or Pad Print

Epoxy based ink is recommended.

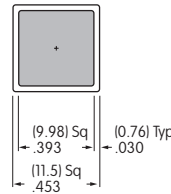

AT465

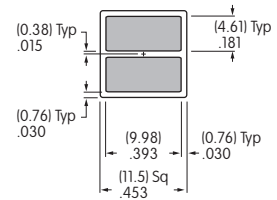

AT465

Shaded areas are printable areas.



# General Specifications

## Electrical Capacity (Resistive Load)

<b>Power Level (code W):</b>	3A @ 125V AC
<b>Logic Level (code G):</b>	0.4VA maximum @ 28V AC/DC maximum (Applicable Range 0.1mA ~ 0.1A @ 20mV ~ 28V)
<b>Logic/Power Level (code A):</b>	Combines W & G ratings Note: See Supplement section to find explanation of operating range.

## Other Ratings

<b>Contact Resistance:</b>	20 milliohms maximum for silver; 30 milliohms maximum for gold
<b>Insulation Resistance:</b>	1,000 megohms minimum @ 500V DC
<b>Dielectric Strength:</b>	1,000V AC minimum between contacts for 1 minute minimum; 1,500V AC minimum between contacts & case for 1 minute minimum
<b>Mechanical Life:</b>	200,000 operations minimum
<b>Electrical Life:</b>	25,000 operations minimum for silver; 100,000 operations minimum for gold
<b>Nominal Operating Force:</b>	Single pole 2.45N; double pole 3.92N
<b>Travel:</b>	Pretravel .024" (0.6mm); Overtravel .016" (0.4mm); Total Travel .039" (1.0mm)

## Materials & Finishes

<b>Plunger:</b>	Brass with nickel plating
<b>Bushing:</b>	Brass with nickel plating
<b>Mounting &amp; Body Frames:</b>	Stainless steel
<b>Support Bracket:</b>	Brass with tin plating
<b>Case:</b>	Polybutylene terephthalate (PBT) (UL94V-0)
<b>Base:</b>	Diallyl phthalate resin
<b>Movable Contactor:</b>	Phosphor bronze with silver or gold plating
<b>Movable Contacts:</b>	Silver alloy (code W); copper with gold plating (code G)
<b>Stationary Contacts:</b>	Silver with silver plating (code W); copper or brass with gold plating (code G)
<b>Terminals:</b>	Copper with silver plating; copper or brass with gold plating

## Environmental Data

<b>Operating Temp Range:</b>	-30°C through +85°C (-22°F through +185°F)
<b>Humidity:</b>	90 ~ 95% humidity for 100 hours @ 40°C (104°F)
<b>Vibration:</b>	10 ~ 55Hz with peak-to-peak amplitude of 1.5mm traversing the frequency range & returning in 1 minute; 3 right angled directions for 2 hours
<b>Shock:</b>	50G (490m/s <sup>2</sup> ) acceleration (tested in 6 right angled directions, with 5 shocks in each direction)

## Installation

<b>Mounting Torque:</b>	1.5Nm (13 lb•in) for double nut; 0.7Nm (6 lb•in) for single nut
<b>Cap Installation Force:</b>	80N (18 lbf) maximum downward force on actuator

## Processing

<b>Soldering:</b>	Wave Soldering Recommended: See Profile B in Supplement section. Manual Soldering: See Profile B in Supplement section.
<b>Cleaning:</b>	These devices are not process sealed. Hand clean locally using alcohol based solution.

## Standards & Certifications

<b>Flammability Standards:</b>	UL94V-0 Case
<b>UL :</b>	<b>File No. E44145 - Recognized only when ordered with marking on switch.</b> Add "/U" or "/CUL" before dash in part number to order UL recognized switch. All single & double pole models recognized at 3A @ 125V AC or 0.4VA max. @ 28V AC/DC max.
<b>CSA:</b>	<b>File No. 023535_0_000 - Certified only when ordered with marking on switch.</b> Add "/C" before dash in part number to order CSA certified switch. Single pole & double pole models certified at 3A @ 125V AC or 0.4VA max. @ 28V AC/DC max.

# Distinctive Characteristics

Short stroke and light touch.

Antijamming design protects contacts from damage due to excessive downward force on the actuator.

High torque bushing construction prevents rotation or separation from frame during installation.

Stainless steel frame resists corrosion.

Longer center solder lug terminal simplifies wiring and soldering.

Patented silver contacts of specially composed alloy for hardness.

Epoxy sealed terminals prevent entry of solder flux and other contaminants.

Snap-acting mechanism gives smooth actuation and audible feedback.

Prominent external insulating barriers increase insulation resistance and dielectric strength.

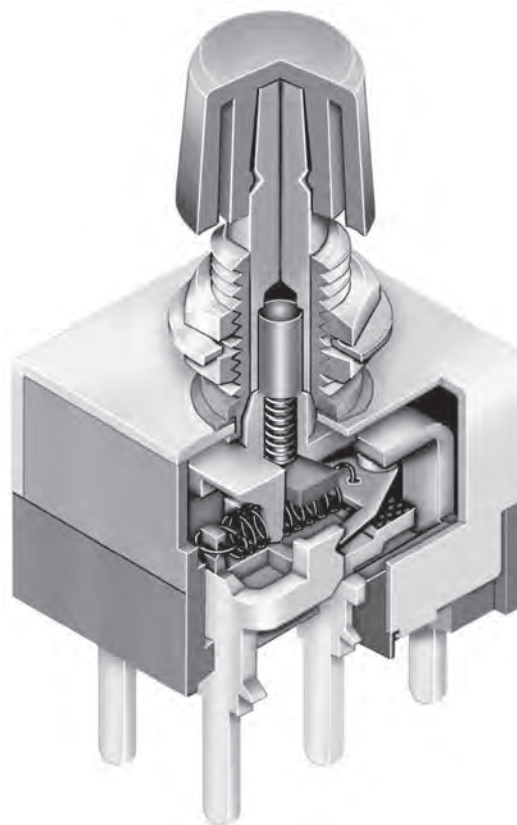

Actual Size

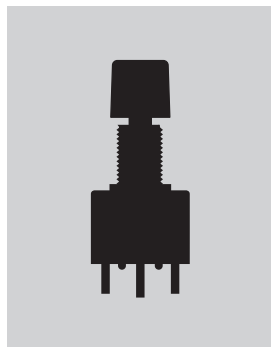

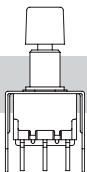
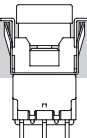
	Bushing Mount	Page C118
	Bracket PC Mount	Page C121
	Snap-in Mount	Page C124

Toggle

Rockers

**C** Pushbuttons

Illuminated PB

Programmable

Key locks

Rotaries

Slides

Tactiles

Tilt

Touch

Indicators

Accessories

Supplement

### TYPICAL SWITCH ORDERING EXAMPLE

**MB25**

**11**

**S4**

**W**

**01**

**B**

**C**

#### Poles & Circuits

11	SPDT	ON	(ON)
21	DPDT	ON	(ON)
( ) = Momentary			

#### Contact Materials & Ratings

<b>W</b>	Silver Rated 3A @ 125V AC
<b>G</b>	Gold Rated 0.4VA max @ 28V AC/DC max

#### Caps

<b>B</b>	.315" (8.0mm) Diameter
<b>C</b>	.394" (10.0mm) Diameter

#### Bushing

<b>S4</b>	.315" (8.0mm) Threaded with Keyway
-----------	---------------------------------------

#### Terminals

<b>01</b>	Solder Lug
<b>03</b>	.250" (6.35mm) Straight PC

#### Cap Colors

<b>A</b>	Black
<b>B</b>	White
<b>C</b>	Red
<b>E</b>	Yellow
<b>F</b>	Green
<b>G</b>	Blue

### IMPORTANT:





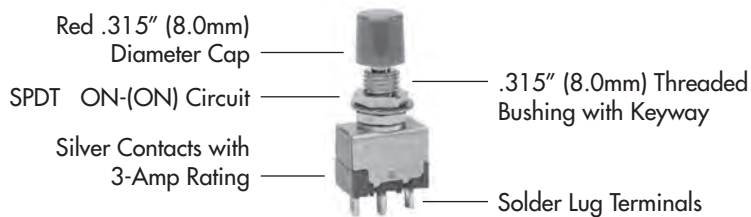

Switches are supplied without UL, cULus & CSA marking unless specified.  
**UL, cULus & CSA recognized only when ordered with marking on the switch.**  
 Specific models, ratings, & ordering instructions are noted on the General Specifications page.

### DESCRIPTION FOR TYPICAL ORDERING EXAMPLE

**MB2511S4W01-BC**

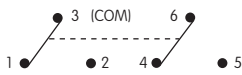

## POLES & CIRCUITS

Pole	Model	Plunger Position ( ) = Momentary		Connected Terminals		Throw & Switch Schematics
		Normal  Keyway	Down 	Normal  Keyway	Down 	
SP	MB2511	ON	(ON)	3-1	3-2	SPDT 
DP	MB2521	ON	(ON)	3-1 6-4	3-2 6-5	DPDT 

Note: Terminal numbers are not actually on the switch.

## BUSHING

**S4** .315" (8.0mm)  
Threaded with Keyway

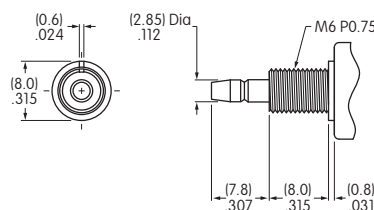

## Panel Cutouts

### Without Keyway

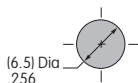

### With Keyway

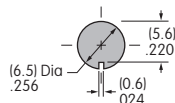

### With Optional Locking Ring

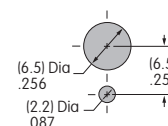

Maximum Panel Thickness with Standard Hardware: .134" (3.4mm)

## Standard Hardware

### AT513M Threaded Hex Nut

2 included with each switch  
Brass with nickel plating

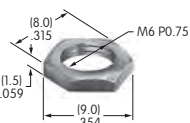

### AT509 Lockwasher

1 included with each switch  
Steel with zinc/chromate

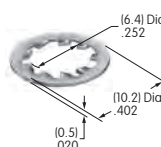

## Optional Hardware

### AT507M Locking Ring

Steel with zinc/chromate

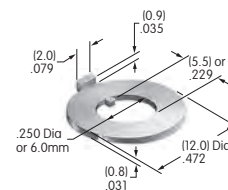

## CONTACT MATERIALS & RATINGS

**W**

Silver over Silver

Power Level

3A @ 125V AC

**G**

Gold over Brass or Copper

Logic Level

0.4VA maximum @ 28V AC/DC maximum

Note: Complete explanation of operating range in Supplement section.

Toggle  
Rockers  
Pushbuttons  
Illuminated PB  
Programmable  
Keylocks  
Rotaries  
Slides  
Tactiles  
Tilt  
Touch  
Indicators  
Accessories  
Supplement

## TERMINALS

**01** Solder Lug

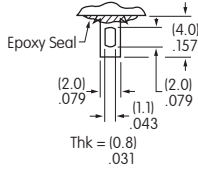

**03** .250" (6.35mm) Straight PC

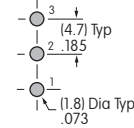
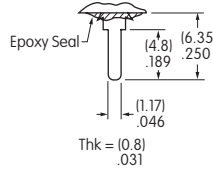

Single Pole

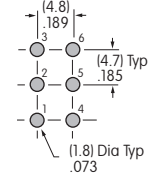

Double Pole

## CAPS & CAP COLORS

**B** AT443  
.315" (8.0mm) Diameter Cap

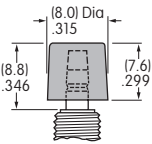

Material: Polycarbonate

Finish: Glossy

**C** AT442  
.394" (10.0mm) Diameter Cap

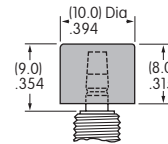

Material: Polycarbonate

Finish: Glossy

Cap Colors Available:



Black



White



Red



Yellow



Green



Blue

## TYPICAL SWITCH DIMENSIONS

Solder Lug

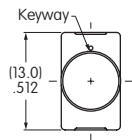

Single Pole

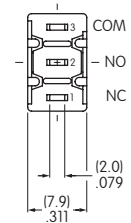
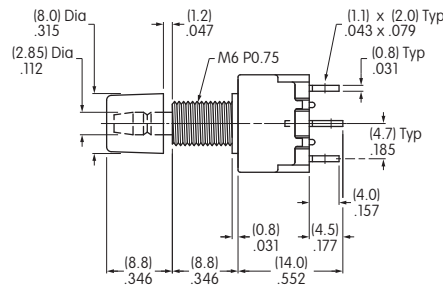

MB2511S4W01-BC

Solder Lug

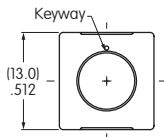

Double Pole

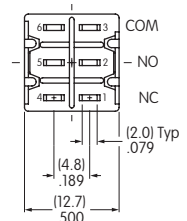
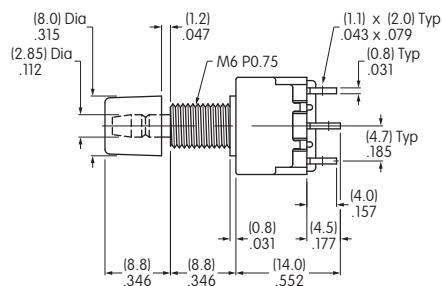

MB2521S4W01-BC



TYPICAL SWITCH ORDERING EXAMPLE

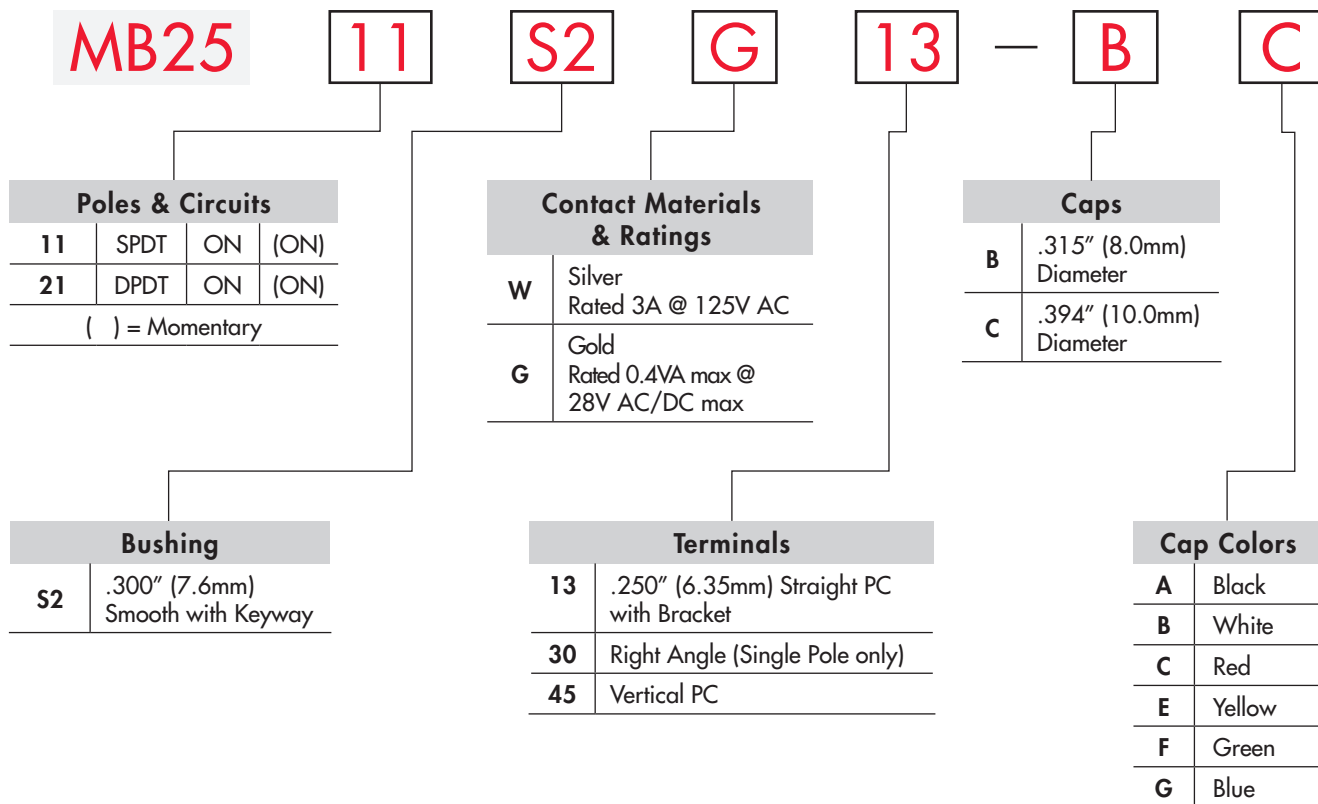

IMPORTANT:





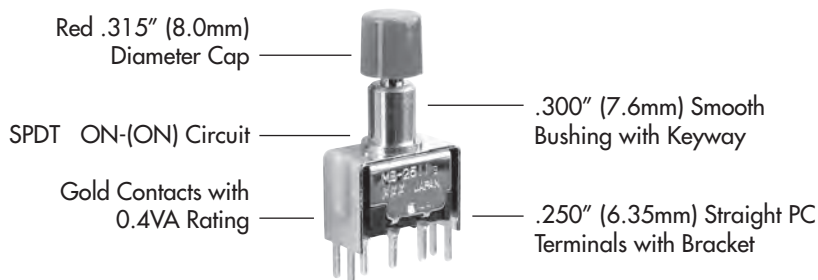

Switches are supplied without UL, cULus & CSA marking unless specified. **UL, cULus & CSA recognized only when ordered with marking on the switch.** Specific models, ratings, & ordering instructions are noted on the General Specifications page.

DESCRIPTION FOR TYPICAL ORDERING EXAMPLE

**MB2511S2G13-BC**

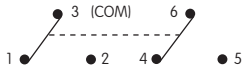

### POLES & CIRCUITS

Pole	Model	Plunger Position ( ) = Momentary		Connected Terminals		Throw & Switch Schematics
		Normal	Down	Normal	Down	
SP	MB2511	ON 	(ON) 	3-1 	3-2 	Note: Terminal numbers are not actually on the switch.  SPDT 
DP	MB2521	ON	(ON)	3-1 6-4	3-2 6-5	DPDT 

### BUSHING

**S2** .300" (7.6mm)  
Smooth with Keyway

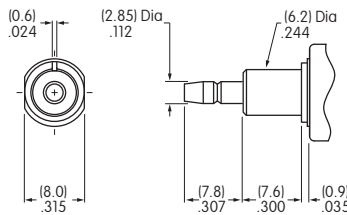

Panel Cutout

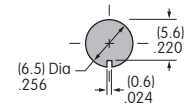

### CONTACT MATERIALS & RATINGS

**W** Silver over Silver

Power Level

3A @ 125V AC

**G** Gold over Brass or Copper

Logic Level

0.4VA maximum @ 28V AC/DC maximum

Note: Complete explanation of operating range in Supplement section.

### TERMINALS

**13** .250" (6.35mm) Terminal  
with .465" (11.8mm) Bracket

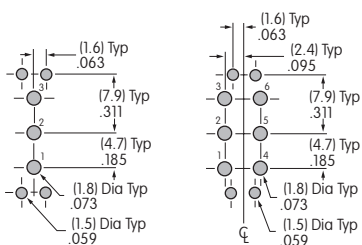
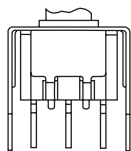

**30** Right Angle PC  
Single Pole only

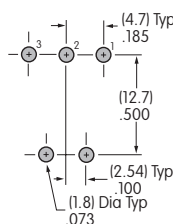
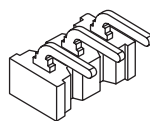

**45** Vertical PC

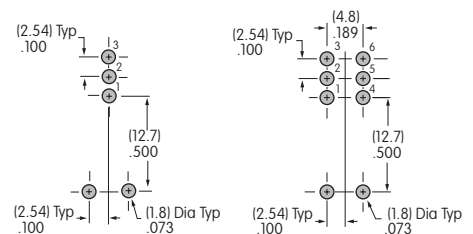
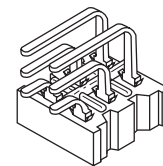

## CAPS & CAP COLORS

**B** AT443  
.315" (8.0mm) Diameter Cap



Material: Polycarbonate

Finish: Glossy

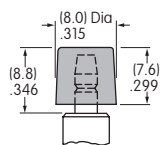

**C** AT442  
.394" (10.0mm) Diameter Cap



Material: Polycarbonate

Finish: Glossy

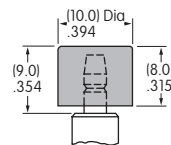

Cap Colors Available:

- A** Black
- B** White
- C** Red
- E** Yellow
- F** Green
- G** Blue

## TYPICAL SWITCH DIMENSIONS

Single Pole      Double Pole      Straight PC • Bracket

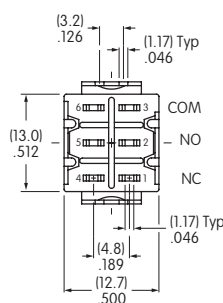
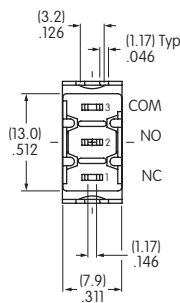
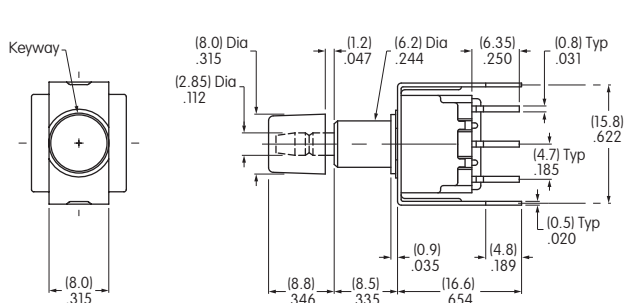

**MB2511S2G13-BC**

Single Pole

Right Angle PC

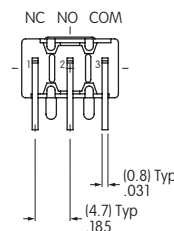
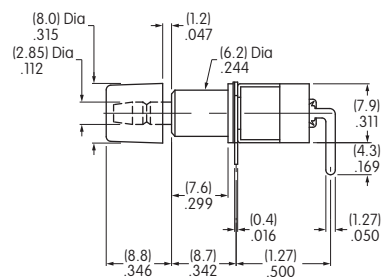
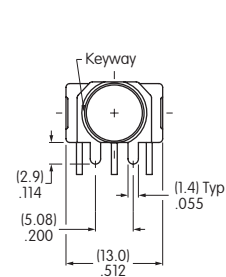

**MB2511S2G30-BC**

Single Pole

Double Pole

Vertical PC

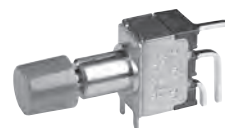
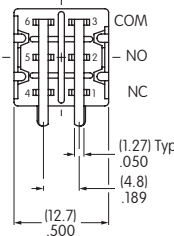
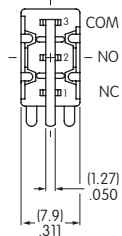
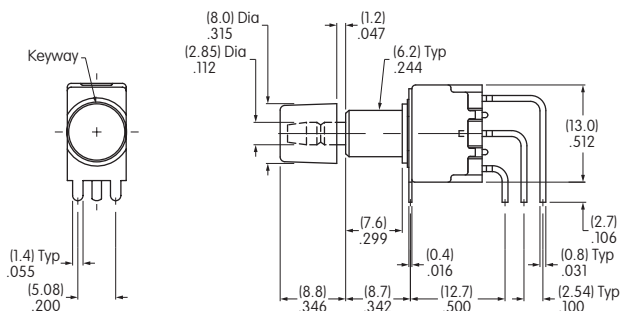

**MB2511S2G45-BC**

### TYPICAL SWITCH ORDERING EXAMPLE

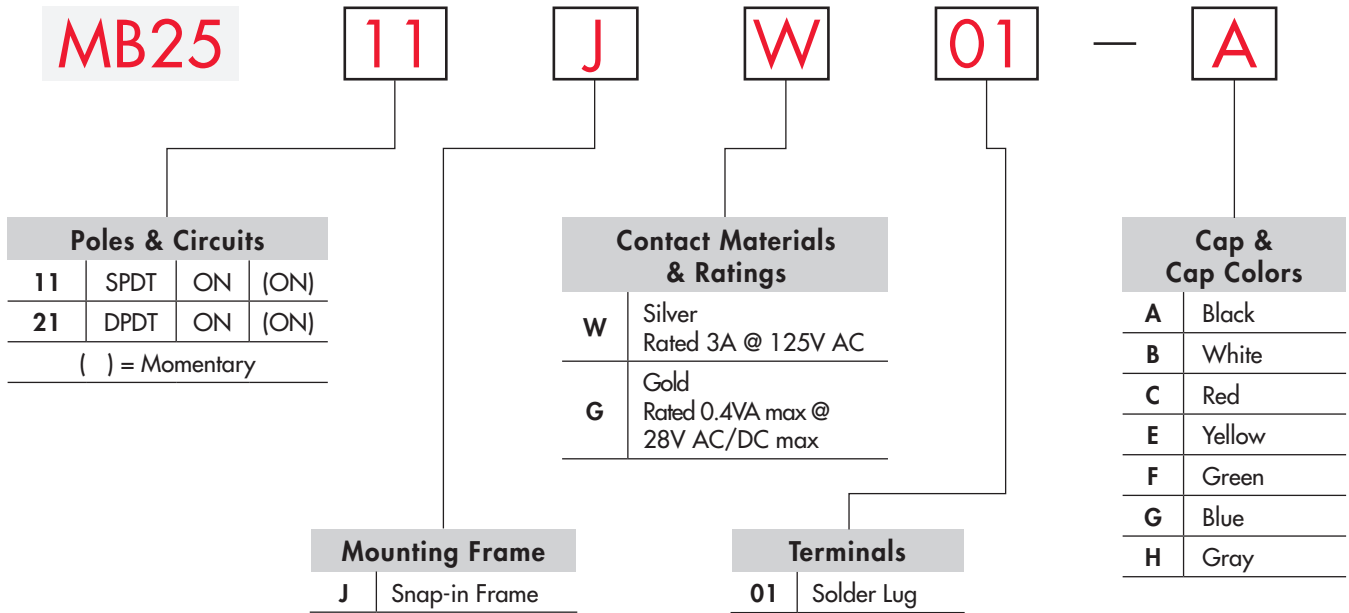

#### IMPORTANT:









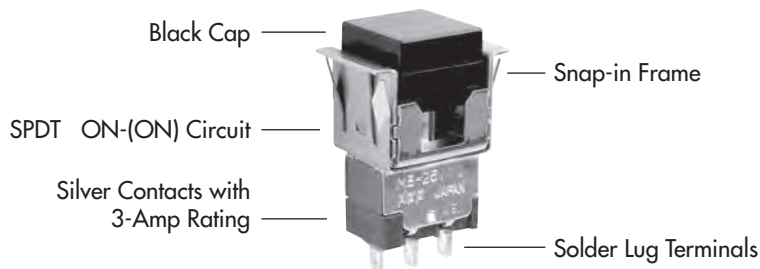

Switches are supplied without UL, cULus & CSA marking unless specified.  
**UL, cULus & CSA recognized only when ordered with marking on the switch.**  
 Specific models, ratings, & ordering instructions are noted on the General Specifications page.

#### DESCRIPTION FOR TYPICAL ORDERING EXAMPLE

#### MB2511JW01-A

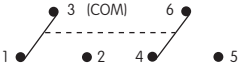

## POLES & CIRCUITS

Pole	Model	Plunger Position ( ) = Momentary		Connected Terminals		Throw & Switch Schematics
		Normal	Down	Normal	Down	
SP	MB2511	ON 	(ON) 	3-1 	3-2 	Note: Terminal numbers are not actually on the switch. SPDT 
DP	MB2521	ON 	(ON) 	3-1 6-4 	3-2 6-5 	DPDT 

## MOUNTING FRAME

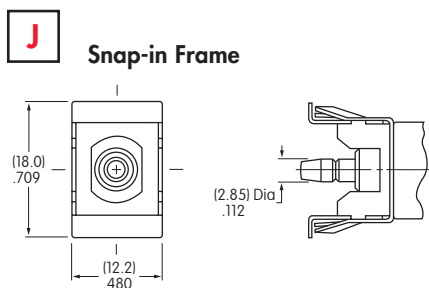

Panel Cutout for Single Pole without Bezel

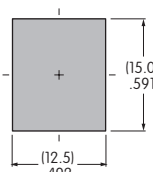

Panel Cutout for Double Pole without Bezel

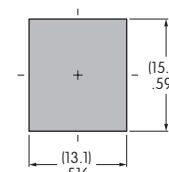

Panel Thickness without Bezel: .039" ~ .157" (1.0mm ~ 4.0mm)  
Panel Thickness with Bezel: .039" ~ .126" (1.0mm ~ 3.2mm)

## CONTACT MATERIALS & RATINGS

**W**

Silver over Silver

Power Level

3A @ 125V AC

**G**

Gold over Brass or Copper

Logic Level

0.4VA maximum @ 28V AC/DC maximum

Note: Complete explanation of operating range in Supplement section.

## TERMINALS

**01**

Solder Lug

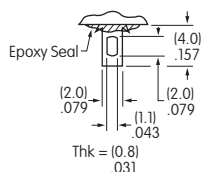

## CAP & CAP COLORS

AT465

.453" (11.5mm) Square Cap

Material: Polycarbonate  
Finish: Glossy

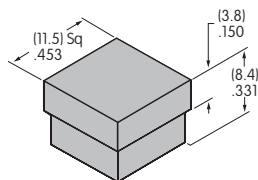

Contact factory for matte finish.

Cap Colors Available:

**A**

Black

**B**

White

**C**

Red

**E**

Yellow

**F**

Green

**G**

Blue

**H**

Gray

Toggle  
Rockers  
Pushbuttons  
Illuminated PB  
Programmable  
Key locks  
Rotaries  
Slides  
Tactiles  
Tilt  
Touch  
Indicators  
Accessories  
Supplement

## TYPICAL SWITCH DIMENSIONS

### Solder Lug



**MB2511JW01-A**

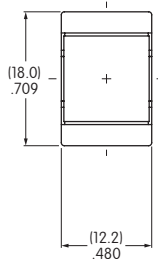

### Single Pole

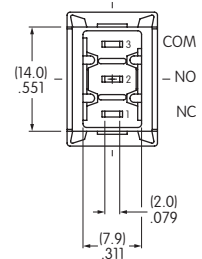
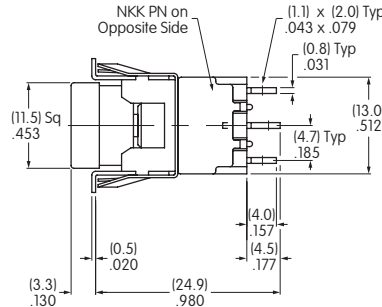

### Solder Lug



**MB2521JW01-C**

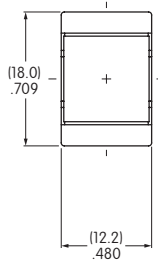

### Double Pole

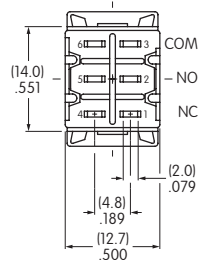
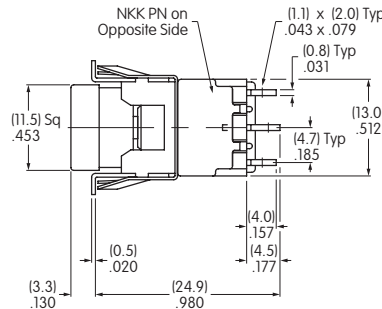

## OPTIONAL SNAP-IN BEZELS & BEZEL COLORS

### AT207 Bezel

Material: Polycarbonate  
Finish: Glossy

Colors:  
Black, White, Red, Yellow,  
Green, Blue, Gray

Contact factory for matte finish.

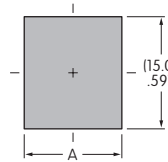
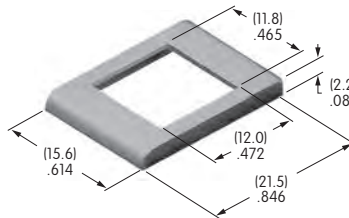

	Single Pole	Double Pole
A	(12.5mm) .492"	(13.1mm) .516"

### AT208 Bezel for AT070 LED

Material: Polycarbonate  
Finish: Glossy

Color: Black

Contact factory for matte finish.

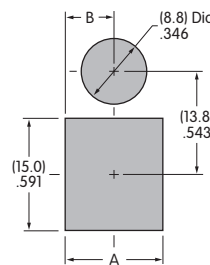
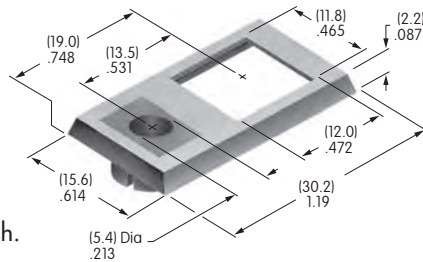

	Single Pole	Double Pole
A	(12.5mm) .492"	(13.1mm) .516"
B	(6.25mm) .246"	(6.55mm) .258"

### AT212 Bezel for AT617 LED

Material: Polycarbonate  
Finish: Semi-glossy

Color: Black

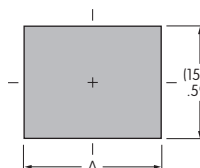
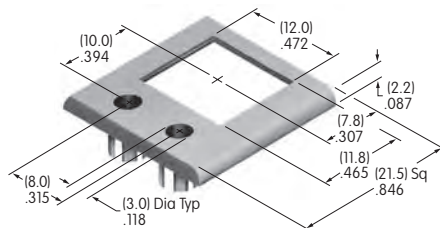

	Single Pole	Double Pole
A	(18.4mm) .724"	(18.7mm) .736"

## OPTIONAL SNAP-IN BEZELS & BEZEL COLORS

### AT213 Bezel for AT618 LED

Material:  
Polycarbonate  
Finish:  
Semi-glossy

Color:  
Black

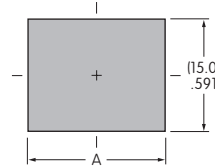
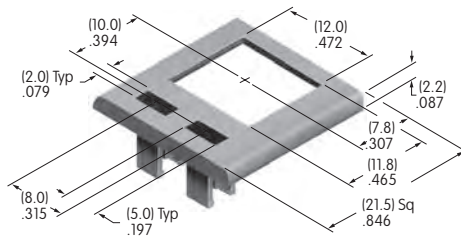

	Single Pole	Double Pole
A	(18.4mm) .724"	(18.7mm) .736"

### Bezel Assembly

1. Pry out tab on bezel to a 45° angle.

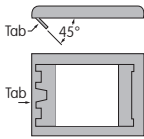

2. Insert switch frame under tab and snap on the bezel.

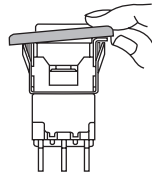

3. Push tab back into place.

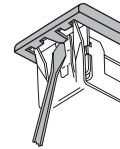

4. Snap assembled bezel and switch into panel.

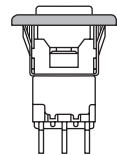

## LED COLORS & SPECIFICATIONS

### Bezel Orientation on Switch

#### AT070 LED For Bezel AT208 with 1 LED

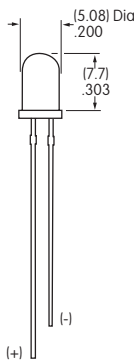
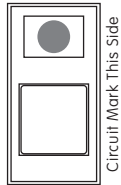

#### AT617 LED For Bezel AT212 with 2 Round LEDs

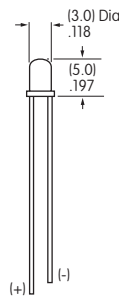
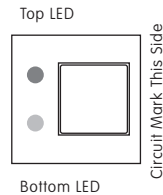

#### AT618 LED For Bezel AT213 with 2 Rectangular LEDs

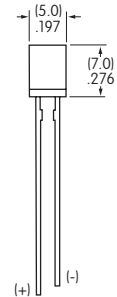
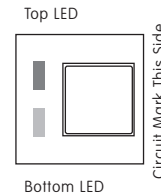

Note: Lead lengths may differ from manufacturing lot to lot. The longer lead is the anode (+).

		AT070		AT617			AT618		
		C	F	C	E	F	C	E	F
	Color	Red	Green	Red	Yellow	Green	Red	Yellow	Green
Maximum Forward Current	$I_{FM}$	25mA	50mA	30mA	30mA	25mA	25mA	30mA	25mA
Typical Forward Current	$I_F$	20mA	30mA	20mA	20mA	20mA	20mA	20mA	20mA
Forward Voltage	$V_F$	2.8V	2.1V	2.0V	2.1V	2.2V	2.25V	2.1V	2.2V
Maximum Reverse Voltage	$V_{RM}$	4V	5V	5V	5V	5V	5V	5V	5V
Current Reduction Rate Above 25°C	$\Delta I_F$	0.33 mA/°C	0.40 mA/°C	0.40 mA/°C	0.40 mA/°C	0.33 mA/°C	0.33 mA/°C	0.40 mA/°C	0.33 mA/°C
Ambient Temperature Range (when used with a bezel)		-10° ~ +70°C		-15° ~ +70°C			-25° ~ +70°C		

The electrical specifications shown are determined at a basic temperature of 25°C. LED circuit is independent of switch operation. LED is colored in OFF state.

If the source voltage is greater than the rated voltage of the LED, a ballast resistor must be connected in series with the LED. The ballast resistor calculation and more lamp detail are shown in the Supplement section.

### GENERAL SPECIFICATIONS FOR SB25, SB60s, SB221s, SB265

#### Electrical Capacity (Resistive Load)

**Power Level:** Shown in the following tables

#### Other Ratings

<b>Contact Resistance:</b>	10 milliohms maximum
<b>Insulation Resistance:</b>	200 megohms minimum @ 500V DC for SB221s, SB25, & SB265; 1,000 megohms minimum @ 500V DC for SB60s.
<b>Dielectric Strength:</b>	1,500V AC minimum for SB265 & SB25 for 1 minute minimum; 2,000V AC minimum between contacts for SB221s & SB60s for 1 minute minimum; 1,500V AC minimum between contacts & case for SB221s & SB60s for 1 minute minimum
<b>Mechanical Life:</b>	50,000 operations minimum for SB221s; 30,000 operations minimum for SB25, SB60s, SB265
<b>Electrical Life:</b>	10,000 operations minimum
<b>Total Travel:</b>	SB221s .116" (2.95mm); SB60s .094" (2.4mm); SB265 .213" (5.4mm); SB25 .195" (4.95mm)
<b>Operating Temp Range:</b>	-10°C through +70°C (+14°F through +158°F)

#### Materials & Finishes

<b>Cap:</b>	Polybutylene terephthalate (PBT) (AT414)
<b>Plunger:</b>	Polyacetal or brass with nickel plating
<b>Bushing:</b>	Brass with nickel plating
<b>Case:</b>	Phenolic resin or melamine phenolic resin
<b>Case Cover:</b>	Steel with zinc plating
<b>Movable &amp; Stationary Contacts:</b>	Copper with silver plating for SB221s; silver alloy with silver plating for SB25, SB60s, & SB265
<b>Terminals:</b>	Copper with tin plating for SB25 & SB60s; copper with silver plating for SB265

#### Installation

**Soldering Time & Temp:** Manual Soldering (Solder Lug): See Profile A in Supplement section.

#### Standards & Certifications

- UL:** **File No. E44145 - Recognized only when ordered with marking on switch.**  
Add "/U" or "/CUL" to end of part number to order UL recognized switch.  
UL or cULus recognition designated beside part numbers on following pages.  
See Supplement section to find UL or cULus rating details.
- CSA:** **File No. 023535\_0\_000 - Certified only when ordered with marking on switch.**  
Add "/C" to end of part number to order CSA certified switch.  
CSA certification designated beside part numbers on following pages.  
See Supplement section to find CSA rating details.



## SINGLE POLE WITH SOLDER LUG OR SCREW LUG

* UL, cULus & CSA recognized only when ordered with marking on switch (see General Specs)			Pushbutton Position/Connected Terminals ( ) = Momentary				Electrical Capacity (Resistive)	
Model	* Approvals UL cULus SP	Pole & Throw	Normal	Keyway	Down	Terminal	AC 125V	AC 250V
SB221NO	— — ✓	SPST	OFF	—	(ON)	1-4	3A	1.5A
SB221NC	✓ ✓ ✓	SPST	ON	1-4	(OFF)	—	3A	1.5A
SB221TNO	— — ✓	SPST	OFF	—	(ON)	1-4	3A	1.5A
SB221TNC	✓ ✓ ✓	SPST	ON	1-4	(OFF)	—	3A	1.5A

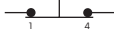
Suffix T = Screw Lug      **Throw & Schematic:**      SPST SB221NO       SPST SB221NC       Note: Terminal numbers are actually on the switch.

**Notes:** Standard Hardware: AT504M Knurled Nut, AT508 Lockwasher, AT527M Hex Backup Nut. See Accessories & Hardware section.

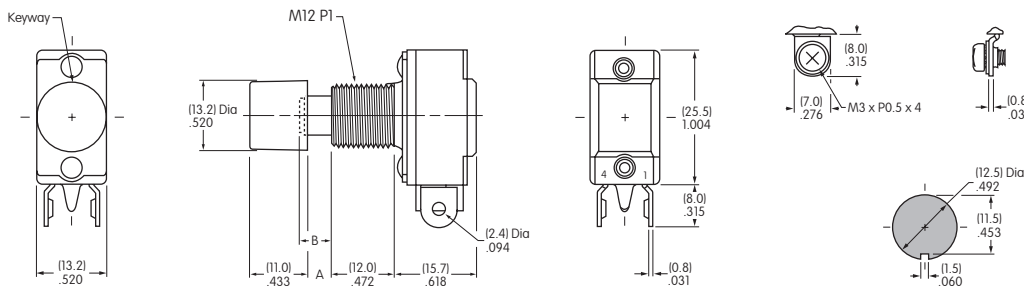

**SB221NO**  
Supplied with AT414 Black Cap

Dimension A: .185" (4.7mm) for NO model & .150" (3.8mm) for NC model.  
Dimension B Plunger Extension: .197" (5.0mm) for NO model & .161" (4.1mm) for NC model.

Panel Thickness .193" (4.9mm)

## DOUBLE POLE WITH SOLDER LUG

* UL & cULus recognized only when ordered with marking on switch (see General Specs)			Pushbutton Position/Connected Terminals ( ) = Momentary				Electrical Capacity (Resistive)	
Model	* Approvals UL cULus SP	Pole & Throw	Normal	Keyway	Down	Terminal	AC 125V	AC 250V
SB61A	✓ ✓ —		ON	2-3 5-6	(ON)	2-1 5-4	10A	5A
SB61B	— — —	DPDT	ON	2-3 5-6	(ON)	2-1 5-4	3A	1.5A
SB63A	— — —	DPDT	ON	2-3 5-6	(ON) or Lockdown ON	2-1 5-4	10A	5A

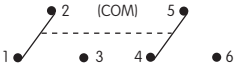
Lockdown for SB63A is achieved by actuating and then turning the button clockwise.      **Throw & Schematic:**      DPDT       Note: Terminal numbers are actually on the switch.

**Notes:** Standard Hardware: AT504M Knurled Nut, AT508 Lockwasher, AT527M Hex Backup Nut. See Accessories & Hardware section.

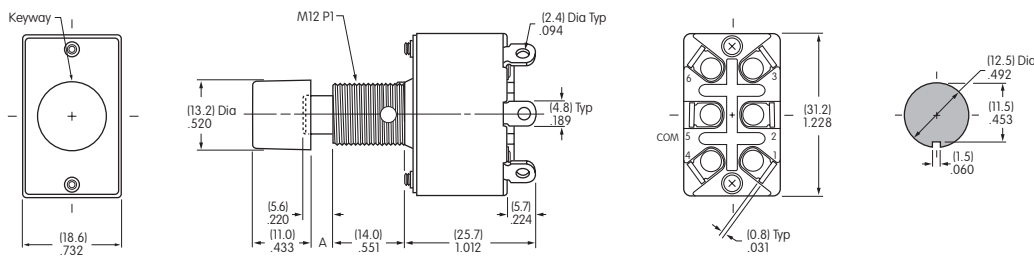

**SB61A**  
Supplied with AT414 Black Cap

Dimension A: .169" (4.3mm) for SB61 model and .130" (3.3mm) for SB63 model.

Panel Thickness .193" (4.9mm)

Toggle

Rockers

Pushbuttons

Illuminated PB

Programmable

Keylocks

Rotaries

Slides

Tactiles

Tilt

Touch

Indicators

Accessories

Supplement

### DOUBLE POLE WITH SOLDER LUG

* UL, cULus & CSA recognized only when ordered with marking on switch (see General Specs)			Pushbutton Position/Connected Terminals ( ) = Momentary		Electrical Capacity (Resistive)	
Model	* Approvals UL cULus US SP	Pole & Throw	Normal Keyway	Down	AC 125V	AC 250V
SB25	✓ ✓ ✓	DPDT	ON 2-3 5-6	ON 2-1 5-4	15A	9A
<b>Throw &amp; Schematic:</b>			DPDT		Note: Terminal numbers are actually on the switch.	

**Notes:** Standard Hardware: AT504M Knurled Nut, AT508 Lockwasher, AT527M Hex Backup Nut. See Accessories & Hardware section.

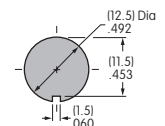
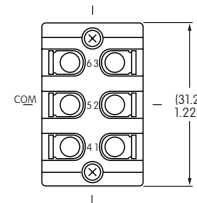
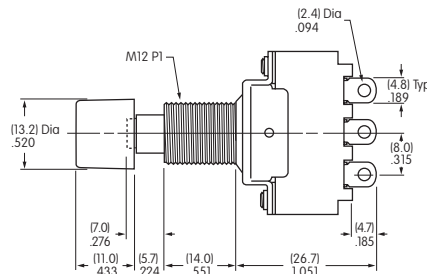
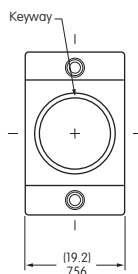

**SB25**

Supplied with AT414 Black Cap

Panel Thickness .193" (4.9mm)

### SINGLE POLE WITH SOLDER LUG

* UL, cULus & CSA recognized only when ordered with marking on switch (see General Specs)			Pushbutton Position/Connected Terminals ( ) = Momentary		Electrical Capacity (Resistive)	
Model	* Approvals UL cULus US SP	Pole & Throw	Normal Keyway	Down	AC 125V	AC 250V
SB265	✓ ✓ ✓	SPST	ON 1-4	OFF -	6A	3A
<b>Throw &amp; Schematic:</b>			SPST		Note: Terminal numbers are actually on the switch.	

**Notes:** Standard Hardware: AT504M Knurled Nut, AT508 Lockwasher, AT527M Hex Backup Nut. See Accessories & Hardware section.

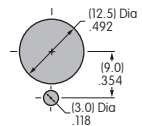
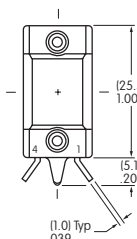
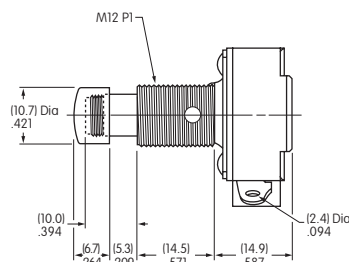
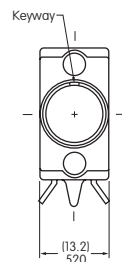

**SB265**

Supplied with Chrome Plated Brass Cap

Panel Thickness .291" (7.4mm)

## GENERAL SPECIFICATIONS

### Electrical Capacity

**Resistive Load:** 15A & ½HP @ 125 or 250V AC for high capacity models  
**Lamp Load:** 5A @ 125V AC

### Other Ratings

**Contact Resistance:** 15 milliohms maximum  
**Insulation Resistance:** 100 megohms minimum @ 500V DC  
**Dielectric Strength:** 1,000V AC minimum between contacts for 1 minute minimum;  
 1,500V AC minimum between contacts & case for 1 minute minimum  
**Mechanical Life:** 1,000,000 operations minimum  
**Electrical Life:** 50,000 operations minimum  
**Travel:** Pretravel .047" (1.19mm); Overtravel .040" (1.01mm); Differential .011" (0.27mm)  
**Operating Temp Range:** -40°C through +85°C (-40°F through +185°F)

### Materials & Finishes

**Caps & Shrouds:** Polycarbonate with glossy finish or PBT  
**Plunger:** Polyacetal or brass with nickel plating  
**Bushing:** Steel with zinc plating or glass fiber reinforced polyamide  
**Case:** Polyester  
**Movable & Stationary Contacts:** Silver alloy  
**Terminals:** Brass with silver plating

### Standards & Certifications

**UL:** Internal snap switch is UL recognized.  
**CSA:** Internal snap switch is CSA certified.

## TYPICAL SWITCH ORDERING EXAMPLE

SCB
2
5
P
15
A
—
4
CA

Poles	
1	SPDT
2	DPDT

Circuits		
5	ON	(ON)
6	ON	ON

( ) = Momentary

Bushings	
P	Plastic (with momentary only)
S	Steel

Rating	
15	15A

Terminals	
A	.187" (4.75mm) Quick Connect
* B	.250" (6.35mm) Quick Connect

Note: Contact factory for availability of screw lug and solder lug models.  
 \* Available in Americas only

Caps & Shrouds	
For Momentary	
3	.520" (13.2mm) Diameter Cap
For Momentary & Alternate Action	
4	Round Cap & Shroud (AT454 & AT455)
5	Rectangular Cap & Shroud (AT452 & AT453)

**DESCRIPTION FOR TYPICAL ORDERING EXAMPLE**

SCB25P15A-4CA

DPDT ON-(ON) Circuit

15A Rating

Round Red Cap with Black Shroud

Plastic Bushing

.187" (4.75mm) Quick Connect Terminals

Colors		
	Caps	Shrouds
A	Black	A
B	White	B
C	Red	—
F	Green	—
G	Blue	—
H	Gray	H

Note: Standard hardware is provided with caps. See Bushing detail for more information.

Toggles  
 Rockers  
 Pushbuttons  
 Illuminated PB  
 Programmable  
 Keylocks  
 Rotaries  
 Slides  
 Tactiles  
 Tilt  
 Touch  
 Indicators  
 Accessories  
 Supplement

Toggles

Rockers

Pushbuttons

Illuminated PB

Keylocks

Rotaries

Slides

Tactiles

Tilt





Touch

Indicators

Accessories

Supplement

## POLES & CIRCUITS

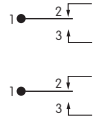
		Plunger Position ( ) = Momentary		Connected Terminals		Throw & Schematics
Pole	Model	Normal 	Down 	Normal 	Down 	Note: Terminal numbers are actually on the switch.
SP	SCB15 SCB16	ON ON	(ON) ON	1-2	1-3	
DP	SCB25 SCB26	ON ON	(ON) ON	1-2 1-2	1-3 1-3	SP with 2 switches 

## BUSHINGS

**P** Plastic  
(for Momentary only)

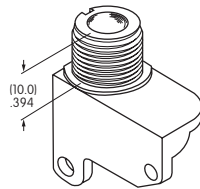

**S** Steel

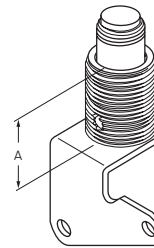

"A" =  
11.2mm  
Momentary  
15.5mm  
Alternate Action

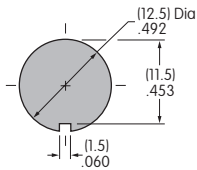

Maximum Effective Panel Thickness:  
.165" (4.2mm) without Shroud  
.157" (4.0mm) with Shroud

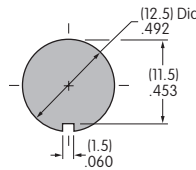

Maximum Effective Panel Thickness:  
Momentary: .177" (4.5mm) without Shroud  
.157" (4.0mm) with Shroud  
Alternate Action: .354" (9.0mm)

### Standard Hardware Provided with Caps

Cap Option 3: AT504M Knurled Face Nut, AT508 Lockwasher, AT527M Hex Mounting Nut

Cap Options 4 & 5: AT508 Lockwasher & AT527M Hex Mounting Nut

## TERMINALS

**A** .187" (4.75mm)  
Quick Connect

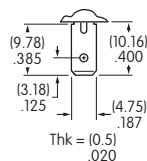

**B** .250" (6.35mm)  
Quick Connect

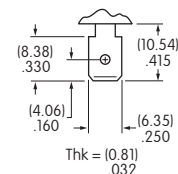

## TYPICAL SWITCH DIMENSIONS

### .520" (13.2mm) Dia. Cap • .187" (4.75mm) Quick Connect

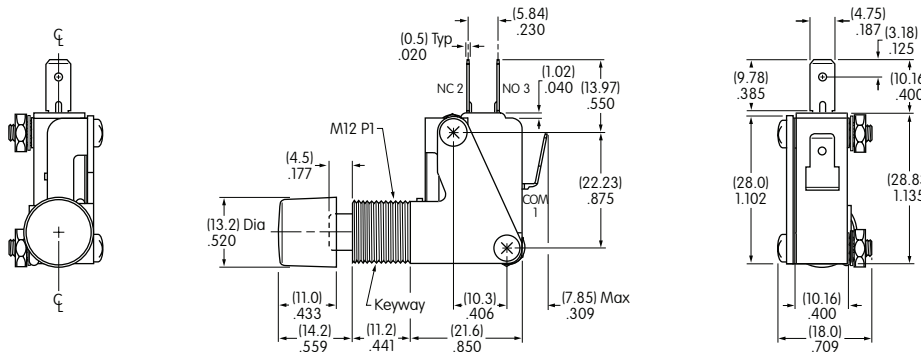

**SCB15S15A-3C**

### Round Cap & Shroud • .187" (4.75mm) Quick Connect

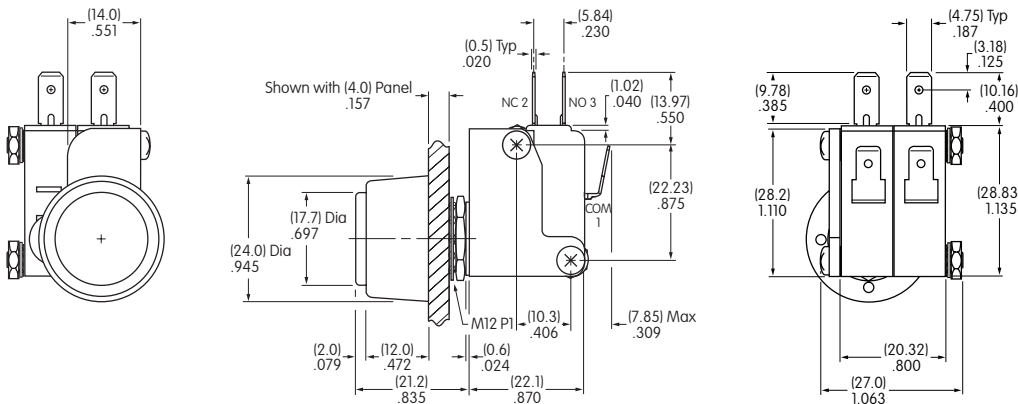

**SCB25P15A-4CA**

### Rectangular Cap & Shroud • .250" (6.35mm) Quick Connect

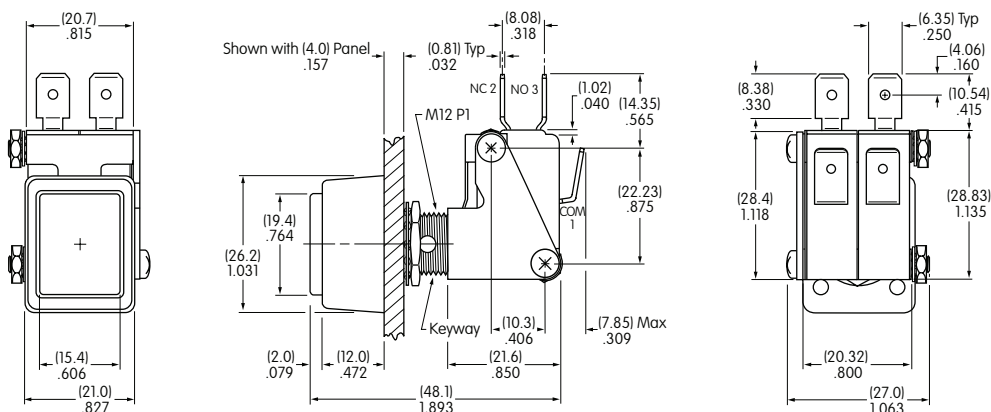

**SCB26S15B-5CA**

# General Specifications

## Electrical Capacity (Resistive Load)

**Power Level:** 6A @ 125V AC & 3A @ 250V AC or 6A @ 30V DC

## Other Ratings

**Contact Resistance:** 10 milliohms maximum for solder lug & screw terminal models  
30 milliohms maximum for wire lead terminal models

**Insulation Resistance:** 200 megohms minimum @ 500V DC

**Dielectric Strength:** 1,500V AC minimum for 1 minute minimum

**Mechanical Life:** 30,000 operations minimum

**Electrical Life:** 15,000 operations minimum

**Contact Timing:** Break before make

**Total Travel:** Alternate Action .177" (4.5mm); Momentary Action .110" (2.8mm)

## Materials & Finishes

**Plunger:** Brass with nickel plating

**Bushing & Outer Case:** Fiberglass reinforced polyamide (UL94V-0 outer case)

**Inner Case:** Melamine

**Inner Sealing Ring:** Silicone rubber

**Outer Sealing Ring:** Nitrile butadiene rubber

**Movable Contactor:** Copper with silver plating

**Movable Contacts:** Silver alloy with silver plating

**Stationary Contacts:** Silver alloy with silver plating

**Terminals:** Brass with tin plating

**Wire Lead Covers:** Heat resistant polyvinyl chloride (Leads are AWG 16.)

## Environmental Data

**Operating Temp Range:** -30°C through +70°C (-22°F through +158°F)

**Humidity:** 90 ~ 95% humidity for 96 hours @ 40°C (104°F)

**Vibration:** 10 ~ 55Hz with peak-to-peak amplitude of 1.5mm traversing the frequency range & returning in 1 minute; 3 right angled directions for 2 hours

**Shock:** 50G (490m/s<sup>2</sup>) acceleration (tested in 6 right angled directions, with 5 shocks in each direction)

## Installation

**Mounting Torque:** 1.5Nm (13 lb•in)

**Soldering Time & Temp:** Manual Soldering: See Profile A in Supplement section.

## Standards & Certifications

**Flammability Standards:** UL94V-0 outer case

**Wiring Material Standards:** UL AWM 1015 Recognized at Flammability VW-1;  
Temperature Range -20°C ~ +105°C; Maximum Load 600V; AWG 16  
CSA TEW 105 Certified at Temperature Range -20°C ~ +105° C;  
Maximum Load 600V

# Distinctive Characteristics

Single unit construction of the bushing and case gives added protection from environmental elements.

Specially designed contact mechanism for breaking light welds.

Minimal contact bounce is achieved with specially designed interlocked switching mechanism.

Outer housing of heat resistant resin meets UL 94V-0 flammability standard and provides high arc and tracking resistance.

Solder lug and screw terminal models meet IP67 of IEC60529 Standards at front panel (dust tight and water protected for temporary immersion). Behind panel standard is IP60 (dust tight but not water protected).

Wire lead models conform fully to IP67 of IEC60529 Standards at front and behind panel (dust tight and water protected for temporary immersion). These models are epoxy sealed at the switch base and covered by an outer case for further protection from dust and water (not operable under water).

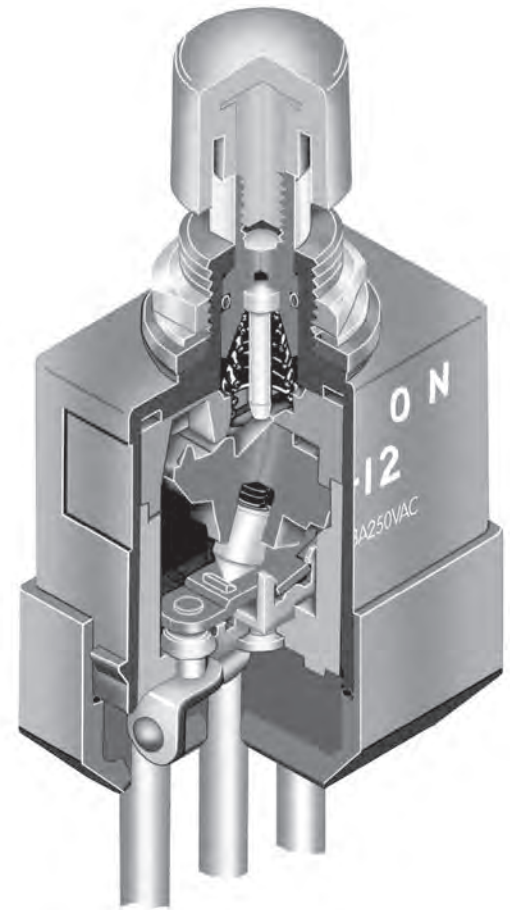

Actual Size

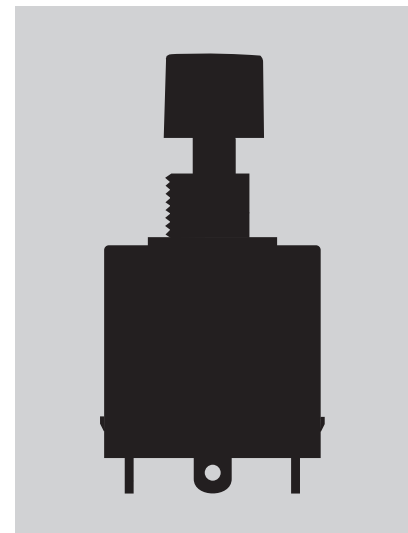

- Supplement
- Accessories
- Indicators
- Touch
- Tilt
- Tactiles
- Slides
- Rotaries
- Key locks
- Programmable
- Illuminated PB
- Pushbuttons
- Rockers
- Toggle

## TYPICAL SWITCH ORDERING EXAMPLE

**WB**

**1**

**2**

**S**

**D**

**A**

### Poles

1 SPDT

### Circuits

2 ON ON  
5 ON (ON)  
( ) = Momentary

### Terminals

S Solder Lug  
T Screw Lug  
L Wire Lead

### Caps

D .520" (13.2mm) Dia.  
E .748" (19.0mm) Dia.

### Cap Colors

A Black  
B White  
C Red  
\*D Amber  
\*E Yellow  
F Green  
\*G Blue  
\*H Gray  
\* Not available with cap code E

### DESCRIPTION FOR TYPICAL ORDERING EXAMPLE

**WB12S-DA**

SPDT  
ON-ON Circuit



Black .520" (13.2mm) Diameter Cap

Solder Lug Terminals

## POLES & CIRCUITS

		Actuator Position ( ) = Momentary		Connected Terminals		Throw & Schematics
Pole	Model	Normal Flat	Down	Normal Flat	Down	Note: Terminal numbers are not actually on wire lead models.  SPDT 
SP	<b>WB12</b>	ON	ON	1-1b	1-1a	
SP	<b>WB15</b>	ON	ON (ON)	1-1b	1-1a	

## STANDARD WIRE COLOR SCHEME

Wire leads are covered with heat resistant vinyl in accordance to UL 1015 and CSA TEW 105 Standards for Appliance Wiring Material (AWM).

### Terminal Numbers & Wire Colors

Models	1a	1	1b
WB12L, WB15L	White	Black	Red

## TYPICAL SWITCH DIMENSIONS

### Solder Lug



**WB15S-DA**

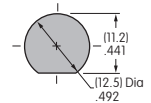
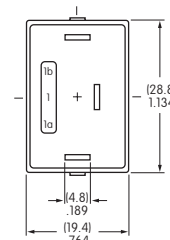
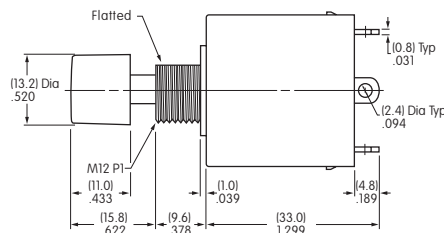
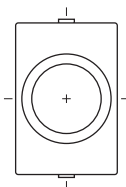

Panel Thickness  
.157" (4.0mm)



## TYPICAL SWITCH DIMENSIONS

### Screw Lug

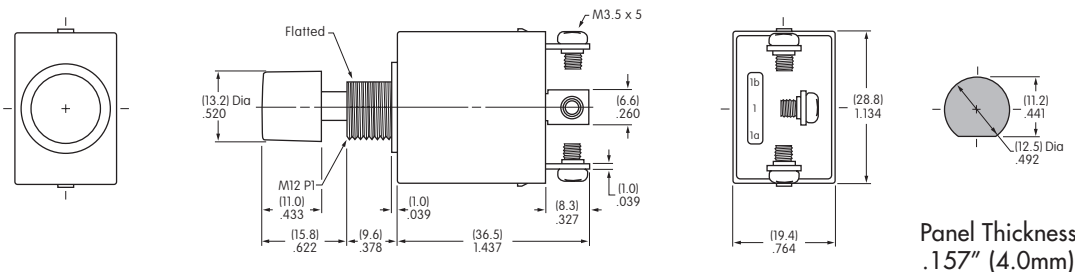

Panel Thickness  
.157" (4.0mm)



**WB12-DA**

### Wire Lead

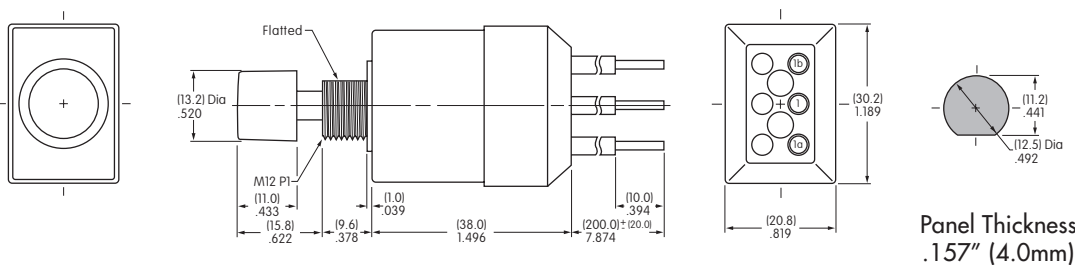

Panel Thickness  
.157" (4.0mm)



**WB12-LA**

## CAPS & CAP COLORS

**D** **AT414**  
.520" (13.2mm) Diameter

Colors Available:  
A B C D E F G H

Material: PBT Finish: Glossy

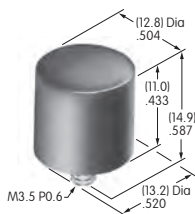

**E** **AT412**  
.748" (19.0mm) Diameter

Colors Available:  
A B C F

Material: Polystyrene Finish: Glossy

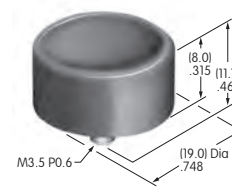

Cap Color Codes: **A** Black **B** White **C** Red **D** Amber **E** Yellow **F** Green **G** Blue **H** Gray

## STANDARD HARDWARE

**AT503M**  
Hex Face Nut

Material:  
Brass with  
chrome plating

1 supplied  
with each  
switch

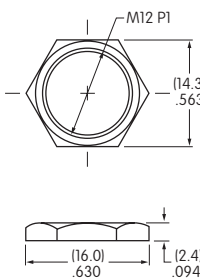

**AT508**  
Internal Tooth Lockwasher

Material:  
Steel with  
zinc/chromate

1 supplied  
with each  
switch

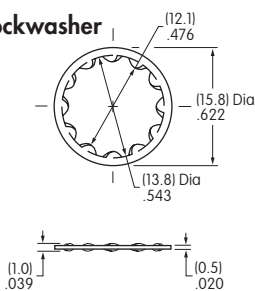

**AT401P**  
O-ring

Material:  
Nitrile  
butadiene  
rubber

1 supplied  
with each  
switch

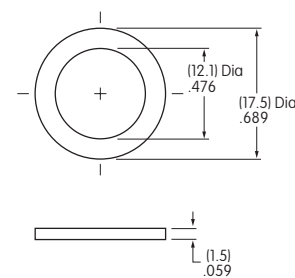

# Notes

---



# Illuminated Pushbuttons

# Contents Illuminated Pushbuttons

Toggles

Rockers

Pushbuttons

Illuminated PB

Programmable

Keylocks

Rotaries

Slides

Tactiles

Tilt

Touch

Indicators

Accessories

Supplement



## FP01 Series ..... D4

Photo Interrupter  
3 Million Actuations  
6-pin Connector  
Snap-in Mount



## GB Series ..... D8

Ultra-miniature Fully Illuminated Plunger  
0.4VA Logic Level  
Process Sealed; Straight, Right Angle & Vertical PC



## HB Series Illum & Nonillum ..... D12

0.1A Power Level; Full Face & Spot Illumination  
Solder Lug  
Rear Panel Threaded Mounting



## HB2 Series ..... D18

Audio/Video Quiet Actuation; 0.4VA Logic Level  
Bicolor LED  
PCB Mounting



## KB Series Illum & Nonillum ..... D22

1A Power Level & 0.4VA Logic Level  
Full Face & Spot Illumination  
Solder Lug; Bushing & Snap-in Mount



## KP Series ..... D36

Audio/Video with Silent & Audible Options  
100mA Low Level  
Bicolor & RGB LEDs; Alternating Legends  
Rectangular Cap Assembly & Home Keys  
PCB Mounting



## LB Series Illum & Nonillum ..... D48

Snap-in Mount  
3A Power Level & 0.4VA Logic Level  
Full Face & Spot Illumination; Super Bright & Bright LEDs  
Solder Lug/Quick Connect



## LB Series Illum & Nonillum .....D59

Panel Seal  
 3A Power Level & 0.4VA Logic Level  
 Full Face & Spot Illumination; Super Bright & Bright LEDs  
 Solder Lug/Quick Connect



## LP01 Series .....D68

Secured Cap Design; 3A Power Level  
 Full Face Illumination  
 Solder Lug/Quick Connect



## NP01 Series Illum & Nonillum....D74

Soft Touch, Smooth Actuation  
 0.4VA Logic Level  
 Bicolor Alternating Legends  
 PCB Mounting



## UB Series Illum & Nonillum .....D80

5A Power Level & 0.4VA Logic Level  
 Full Face & Spot Illumination; Bicolor Alternating Legends  
 Solder Lug & Straight PC  
 PCB & Snap-in Mount



## UB2 Series Illum & Nonillum .....D92

5A Power Level & 0.4VA Logic Level  
 Variety of Illumination Effects; Alternating Legends  
 Bright, Super Bright, & Bicolor LEDs  
 Solder Lug & Straight PC; PCB & Snap-in Mount



## YB Series Illum & Nonillum ..... D104

3A Power Level & 0.4VA Logic Level  
 Full Face & Spot Illumination  
 Incandescent & Multi-element LEDs  
 Solder Lug/Quick Connect & Straight PC  
 Bushing & Snap-in Mount



## YB2 Series Illum & Nonillum .... D118

22mm Flush Mount Panel Seal  
 3A Power Level & 0.4VA Logic Level  
 Cap Option with Illumination Ring  
 Solder Lug/Quick Connect

Toggle

Rockers

Pushbuttons

**D** Illuminated PB

Programmable

Key locks

Rotaries

Slides

Tactiles

Tilt

Touch

Indicators

Accessories

Supplement

# Distinctive Characteristics

Brilliant illumination for highly visible status indication with LEDs and caps in red, green, or amber; subdued illumination for low light requirements with white cap over red, green, or amber LEDs.

Photo interrupter, rather than contacts, ensures high reliability and long life of 3 million operations minimum.

Rugged construction and smooth actuation allow repeated, rapid actuation force anywhere on cap surface.

Snap-in mounting for easy installation.

Connector socket with 6 pins for simple connection.

Well suited for gaming and vending machines, as well as equipment exposed to corrosive gases used in environments such as chemical or steel manufacturing plants.

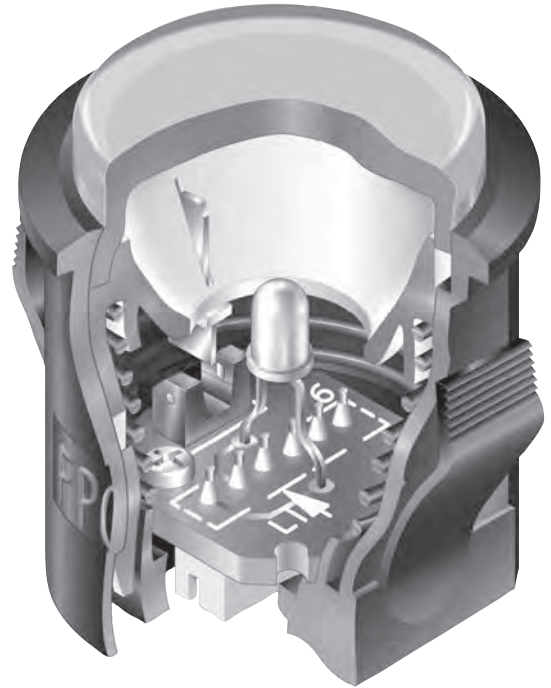

Actual Size



TYPICAL SWITCH ORDERING EXAMPLE

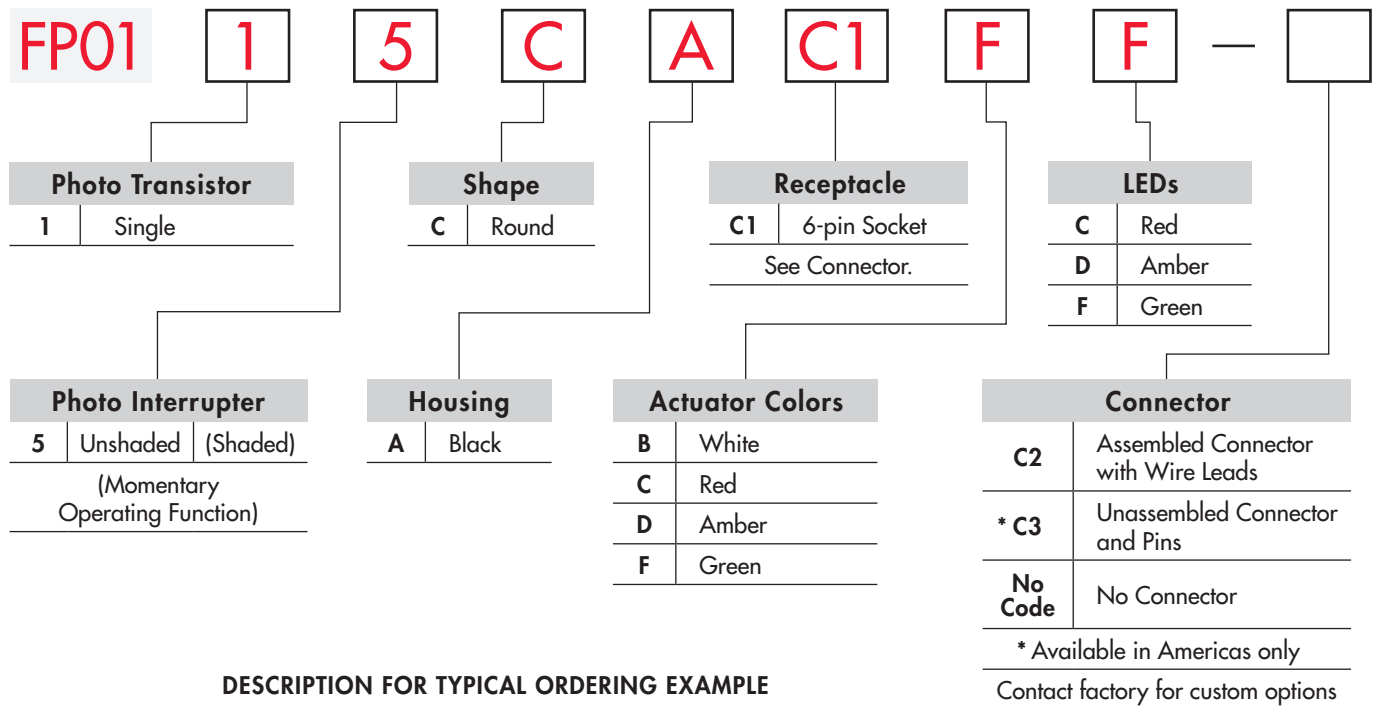

DESCRIPTION FOR TYPICAL ORDERING EXAMPLE

FP0115CAC1FF



ACTUATOR & INTERRUPTER

		Actuator Position		Photo Interrupter		Schematics
Model	<b>1</b>	Normal 	Down 	Unshaded <b>5</b>	Shaded	LED connector pins are 5 & 6; interrupter connector pins are 3-4 & 1-2.
				Normally Unshaded with Momentary Shaded status		
FP0115	Single Photo Transistor	When shaded, the photo transistor momentarily activates electrical function which signals the external device to change its state.				

HOUSING SHAPE & COLOR

**C** Round Shape

**A** Black Housing

**C1** 6-pin Socket

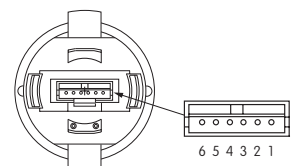

Toggle  
Rockers  
Pushbuttons  
Illuminated PB  
Programmable  
Keylocks  
Rotaries  
Slides  
Tactiles  
Tilt  
Touch  
Indicators  
Accessories  
Supplement

Toggles

Rockers

Pushbuttons

Illuminated PB

Programmable

Keylocks

Rotaries

Slides

Tactiles

Tilt

Touch

Indicators

Accessories

Supplement

## SWITCH SPECIFICATIONS

	Actuator Up	Actuator Down
Status of Photo Interrupter:	Unshaded	Shaded
Collector Current $I_C$ :	0.8mA minimum	10 $\mu$ A maximum
Status of Photo Transistor:	On	Off
Output Condition of Photo Transistor:	$I_F = 20\text{mA}$ & $V_{CE} = 5\text{V}$	

## MECHANICAL SPECIFICATIONS

Total Travel:	.079" (2.0mm)
Operating Force:	0.75 N (.169 lbf)
Mechanical Life:	3,000,000 operations minimum
Operating Temperature Range:	-25°C through +50°C (-13°F through +122°F)

## MATERIALS

Actuator: Polyacetal    Housing: Polyamide

## PHOTO INTERRUPTER SPECIFICATIONS

(Temperature @ 25°C)

Electrical & Optical Characteristics	Typical	Maximum	Condition
<b>Input</b>			
Forward Voltage $V_F$ :	1.3V	1.6V	$I_F = 50\text{mA}$
Reverse Current $I_R$ :		10 $\mu$ A	$F_R = 5\text{V}$
<b>Transmission</b>			
Collector-Emitter Saturation Voltage $V_{CE\text{ sat}}$ :		0.4V	$I_F = 20\text{mA}$ & $I_C = 0.1\text{mA}$
<b>Absolute Maximum Ratings</b>			
<b>Input LED</b>		<b>Output Photo Transistor</b>	
Typical Forward Current $I_F$ :	50mA	Collector-Emitter Voltage $V_{CEO}$ :	30V
Reverse Voltage $V_R$ :	5V	Emitter-Collector Voltage $V_{ECO}$ :	4.5V
Power Dissipation $P_D$ :	80mW	Collector Current $I_C$ :	30mA
		Collector Dissipation $P_C$ :	80mW

### Circuit Design Considerations

Output of the infrared LED in the photo interrupter decreases approximately 50% after 100,000 hours.

Recommended load resistance ( $R_L$ ) is 40k ~ 120k $\Omega$  for the illustrated circuit.

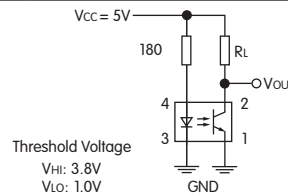

## LED COLORS & SPECIFICATIONS

LEDs are an integral part of the switch and not available separately. The electrical specifications shown are determined at a basic temperature of 25°C.

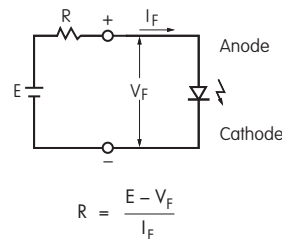

$$R = \frac{E - V_F}{I_F}$$

Where: R = Resistor Value (Ohms)  
E = Source Voltage (V)  
 $V_F$  = Forward Voltage (V)  
 $I_F$  = Forward Current (A)

If the source voltage exceeds the rated voltage, a ballast resistor is required.

Single Element LED	Color	<b>C</b> Red	<b>D</b> Amber	<b>F</b> Green
Maximum Forward Current	$I_{FM}$	30mA	25mA	25mA
Typical Forward Current	$I_F$	20mA	20mA	20mA
Forward Voltage	$V_F$	1.85V	2.0V	2.25V
Maximum Reverse Voltage	$V_{RM}$	5V	5V	5V
Current Reduction Rate Above 25°C	$\Delta I_F$	0.38mA /°C	0.28mA /°C	0.40mA /°C
Ambient Temperature Range		-25° ~ +50°C		



## ACTUATOR COLORS



White



Red



Amber



Green

## CONNECTOR OPTIONS



**AT021**  
Assembled Connector  
with Wire Leads

Connector body: JST model ZHR-6  
Crimp connector pins: JST model SZH-002T-P0.5  
Wire leads: 28-26AWG; 12-inch, unstripped;  
Blue for Pin 1



**AT022**  
Unassembled Connector  
and Pins

1 connector and 8 crimp connector pins  
only (no wire leads provided).

Matching wire leads: 28-26AWG



**No Connector**

Recommended connector  
for assembly:  
JST model number ZHR-6

Recommended crimp  
connector pins:  
JST model SZH-002T-P0.5  
for 28-26AWG wire leads  
or SZH-003T-P0.5 for  
32-28AWG wire leads.

## TYPICAL SWITCH DIMENSIONS

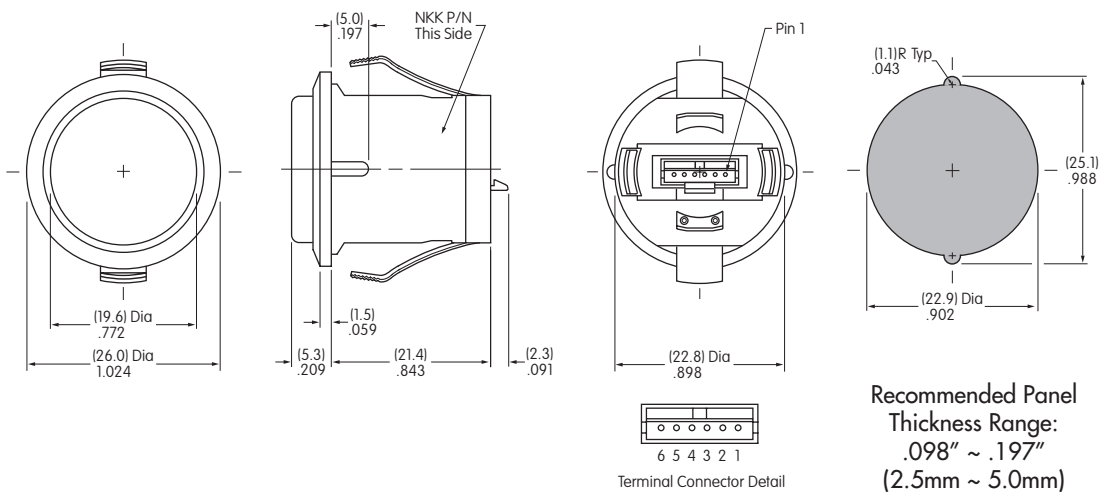

## LEGENDS

NKK Switches can provide custom legends for caps. Contact factory for more information.

### Suggested Printable Area for FP01 Cap



#### Recommended Methods:

Screen Print on cap.  
Epoxy based ink is recommended.

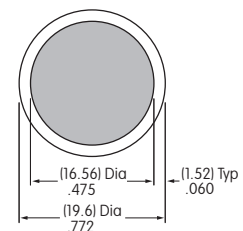

Shaded area is printable area.

# General Specifications

## Electrical Capacity (Resistive Load)

**Logic Level:** 0.4VA maximum @ 28V AC/DC maximum  
(Applicable Range 0.1mA ~ 0.1A @ 20mV ~ 28V)  
Note: Find additional explanation of operating range in Supplement section.

## Other Ratings

**Contact Resistance:** 80 milliohms maximum  
**Insulation Resistance:** 500 megohms minimum @ 500V DC  
**Dielectric Strength:** 500V AC minimum for 1 minute minimum  
**Mechanical Life:** 50,000 operations minimum  
**Electrical Life:** 50,000 operations minimum  
**Nominal Operating Force:** 1.70N  
**Travel:** Pretravel .035" (0.9mm); Overtravel .008" (0.2mm); Total Travel .043" (1.1mm)

## Materials & Finishes

**Plunger:** Polyamide  
**Case:** Glass fiber reinforced polyamide  
**Sealing Rings:** Nitrile butadiene rubber  
**Movable Contact:** Phosphor bronze with gold plating  
**Stationary Contacts:** Phosphor bronze with gold plating  
**Base:** Glass fiber reinforced polyamide  
**Switch Terminals:** Phosphor bronze with gold plating  
**Lamp Terminals:** Phosphor bronze with gold plating

## Environmental Data

**Operating Temperature Range:** -25°C through +55°C (-13°F through +131°F)  
**Humidity:** 90 ~ 95% humidity for 240 hours @ 40°C (104°F)  
**Vibration:** 10 ~ 500Hz with peak-to-peak amplitude of 1.5mm traversing the frequency range & returning in 15 minutes; 3 right angled directions for 2 hours  
**Shock:** 50G (490m/s<sup>2</sup>) acceleration (tested in 6 right angled directions, with 5 shocks in each direction)

## PCB Processing

**Soldering:** Wave Soldering recommended. See Profile A in Supplement section.  
Manual Soldering: See Profile A in Supplement section.  
**Cleaning:** Automated alcohol based cleaning recommended, 5 minutes maximum. Do not use high-purity alcohol (50% alcohol or more) or organic solvent. High alcohol solution can damage clear plastic. See Cleaning specifications in Supplement section.

## Standards & Certifications

The GB Series illuminated pushbuttons have not been tested for UL recognition or CSA certification. These switches are designed for use in a low-voltage, low-current, logic-level circuit. When used as intended in a logic-level circuit, the results do not produce hazardous energy.

# Distinctive Characteristics

Fully illuminated plunger for highly visible status indication with single color LED in red, green, or amber.

Ultra-miniature size allows high density mounting, and extremely light weight makes these switches ideal for handheld equipment.

Totally sealed body construction prevents contact contamination and allows time- and money-saving automated soldering and cleaning. Insert-molded terminals lock out flux, solvents, and other contaminants.

Award-winning STC contact mechanism with benefits unavailable in conventional mechanisms: smooth, positive detent actuation, increased contact stability, and unparalleled logic-level reliability. (Additional STC details in Terms & Acronyms; see Supplement section.)

.100" x .100" (2.54mm x 2.54mm) terminal spacing conforms to standard PC board grid spacing. Round terminals facilitate easier through-hole mounting on PC boards.

Nonilluminated pushbuttons available and shown in the Pushbutton section.



Actual Size

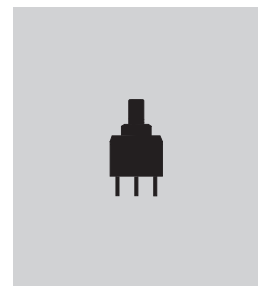

- Supplement
- Accessories
- Indicators
- Touch
- Tilt
- Tactiles
- Slides
- Rotaries
- Key locks
- Programmable
- D** Illuminated PB
- Pushbuttons
- Rockers
- Toggle

### TYPICAL SWITCH ORDERING EXAMPLE

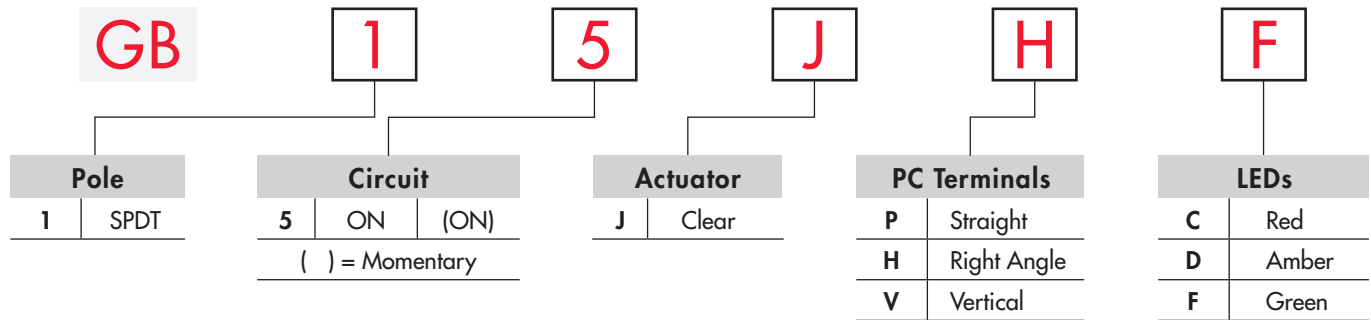

### DESCRIPTION FOR TYPICAL ORDERING EXAMPLE

**GB15JHF**

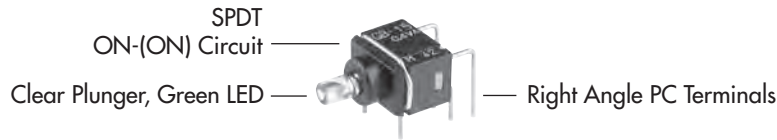

### POLE & CIRCUIT

Pole	Model	Plunger Position ( ) = Momentary		Connected Terminals		Throw & Switch/Lamp Schematics
		Normal	Down	Normal	Down	
SP	GB15	ON	(ON)	5-6	5-4	Note: Terminal numbers are not actually on the switch. LED circuit is isolated and requires an external power source. 

### ACTUATOR

**J** Clear Plunger

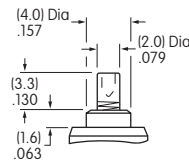

### LED COLORS & SPECIFICATIONS

LEDs are an integral part of the switch and not available separately. The electrical specifications shown are determined at a basic temperature of 25°C.

If the source voltage exceeds the rated voltage, a ballast resistor is required.

The resistor value can be calculated by using the formula in the Supplement section.

		<b>C</b>	<b>D</b>	<b>F</b>
Colors		Red	Amber	Green
Maximum Forward Current	$I_{FM}$	30mA	30mA	30mA
Typical Forward Current	$I_F$	20mA	20mA	20mA
Forward Voltage	$V_F$	1.95V	2.0V	2.1V
Maximum Reverse Voltage	$V_{RM}$	5V	5V	5V
Current Reduction Rate Above 25°C	$\Delta I_F$	0.40mA/°C	0.40mA/°C	0.40mA/°C
Ambient Temperature Range		-25° ~ +55°C		

## PC TERMINALS

**P** Straight

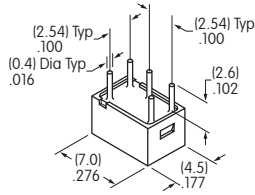

**H** Right Angle

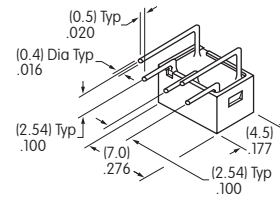

**V** Vertical

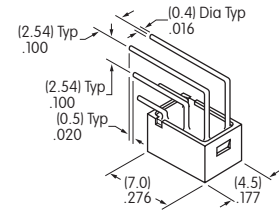

## TYPICAL SWITCH DIMENSIONS

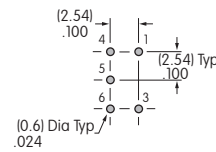
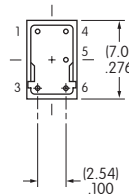
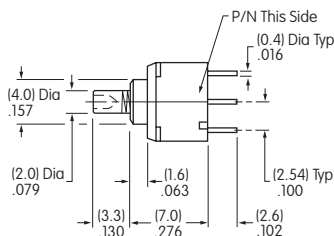
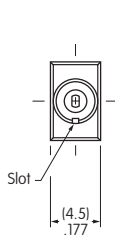

**Straight PC**



Terminals 1 & 3 are lamp terminals.

**GB15JPD**

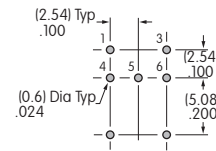
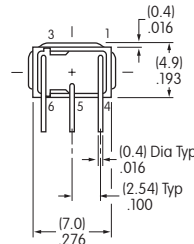
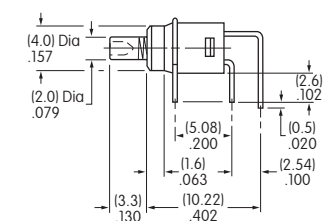
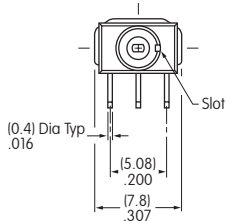

**Right Angle PC**



Terminals 1 & 3 are lamp terminals.

**GB15JHF**

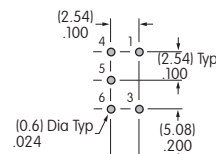
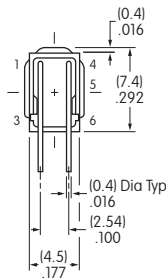
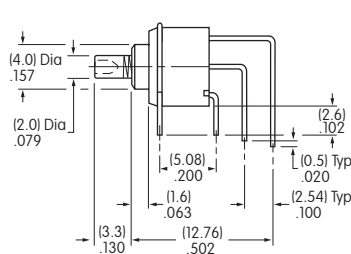
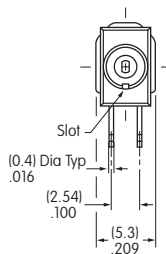

**Vertical PC**



Terminals 1 & 3 are lamp terminals.

**GB15JVC**

# General Specifications

## Electrical Capacity (Resistive Load)

**Power Level (silver):** 0.1A maximum @ 30V AC/DC

## Other Ratings

**Contact Resistance:** 50 milliohms maximum  
**Insulation Resistance:** 100 megohms minimum @ 500V DC  
**Dielectric Strength:** 500V AC minimum for 1 minute minimum  
**Mechanical Life:** 100,000 operations minimum  
**Electrical Life:** 50,000 operations minimum  
**Nominal Operating Force:** 3.43N  
**Contact Timing:** Nonshorting (break before make)  
**Travel:** Pretravel .087" (2.2mm); Overtravel .031" (0.8mm); Total Travel .118" (3.0mm)

## Materials & Finishes

**Housing:** Glass fiber reinforced polyamide  
**Base:** Glass fiber reinforced polyamide  
**Movable Contact:** Phosphor bronze with silver plating  
**Stationary Contacts:** Phosphor bronze with silver plating  
**Common Terminal:** Phosphor bronze with silver plating  
**End Terminals:** Phosphor bronze with silver plating  
**Lamp Terminals:** Phosphor bronze with silver plating

## Environmental Data

**Operating Temperature Range:** -25°C through +50°C (-13°F through +122°F) for Illuminated  
 -25°C through +70°C (-13°F through +158°F) for Nonilluminated  
**Humidity:** 90 ~ 95% humidity for 96 hours @ 40°C (104°F)  
**Vibration:** 10 ~ 55Hz with peak-to-peak amplitude of 1.5mm traversing the frequency range & returning in 1 minute; 3 right angled directions for 2 hours  
**Shock:** 50G (490m/s<sup>2</sup>) acceleration (tested in 6 right angled directions, with 5 shocks in each direction)

## Installation

**Mounting Torque:** 0.49Nm (4.34 lb•in) maximum for round mounting nut  
**Cap Installation Force:** 9.8N (2.2 lbf) maximum downward force on cap  
**Soldering Time & Temperature:** Manual Soldering: See Profile A in Supplement section.

## Standards & Certifications

**UL:** File No. E44145 - Recognized only when ordered with marking on switch.  
 Add "/U" or "/CUL" before first dash in part number to order UL recognized switch.  
 All models recognized at 0.1A @ 30V AC/DC.

# Distinctive Characteristics

Full face and spot illumination available. Front panel relamping.

Choice of super bright LEDs in white, green, and blue in addition to bright red, amber, and green LEDs.

Compact front panel design with 9mm square or round bezel options.

Rear panel threaded mounting. Behind panel depth of less than one inch. 8mm body diameter fits common size panel cutout.

Latchdown feature gives indication of circuit status. Audible and tactile feedback with smooth and responsive operation.

Dual, sliding contacts with self-cleaning action provide contact stability, high reliability, and increased operating life.

Solder lug terminals have spacing of .100" (2.54mm) for choice of mounting.

Longer normally closed terminal facilitates wiring and soldering.

Molded-in terminals lock out flux, dust, and other contaminants.

Matching indicators available.

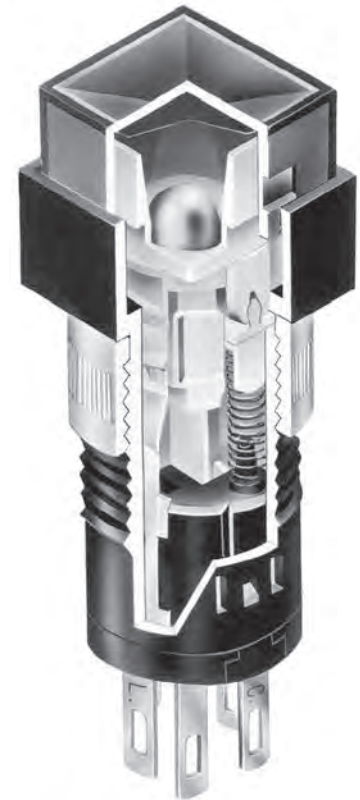

Actual Size

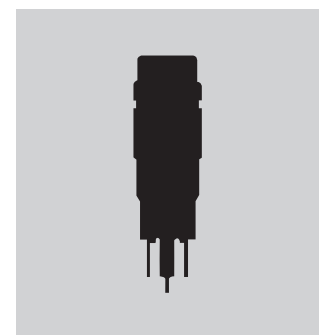

### TYPICAL SWITCH ORDERING EXAMPLE

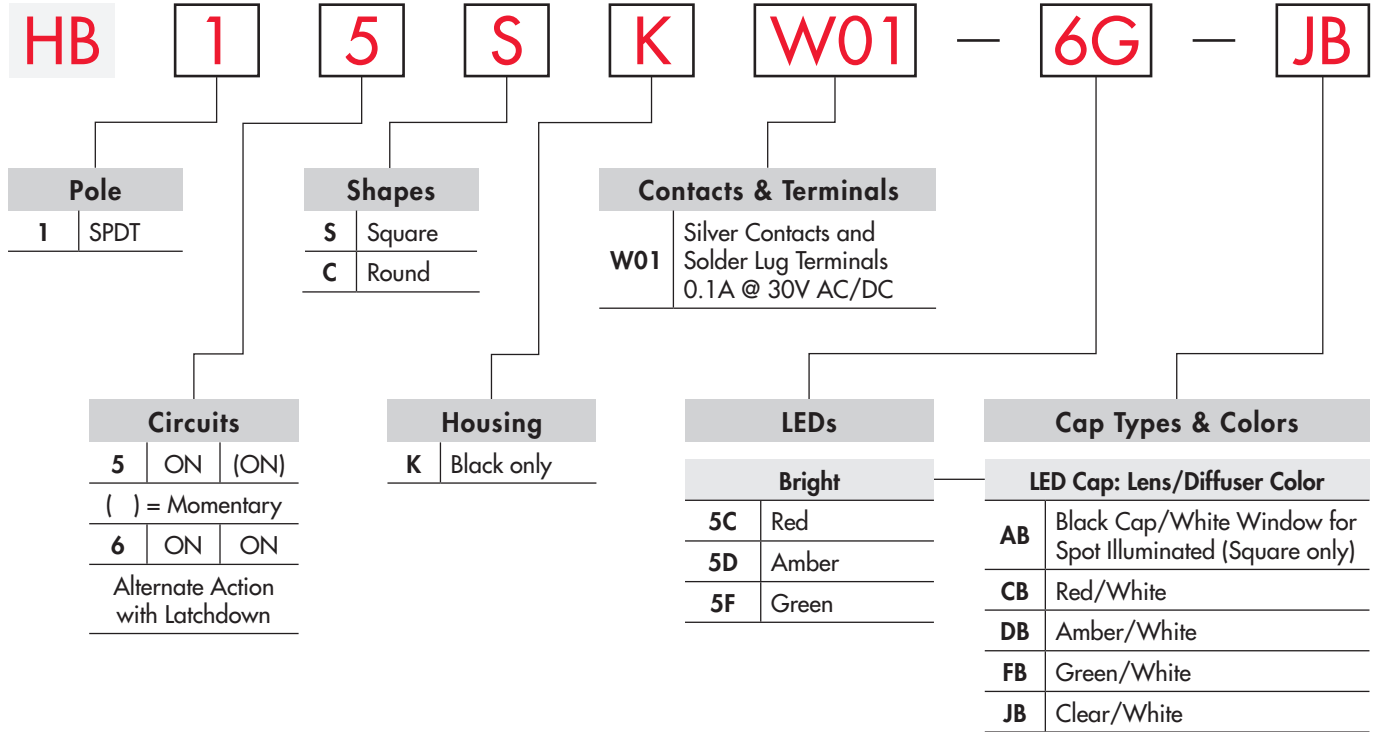

#### IMPORTANT:



Switches are supplied without UL & cULus marking unless specified. **UL & cULus recognized only when ordered with marking on the switch.** Specific models, ratings, & ordering instructions are noted on the General Specifications page.

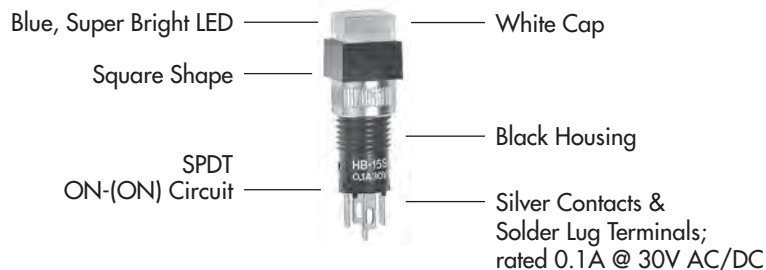

#### DESCRIPTION FOR TYPICAL ORDERING EXAMPLE

#### HB15SKW01-6G-JB





## POLES & CIRCUITS

		Plunger Position ( ) = Momentary		Connected Terminals		Throw & Switch/Lamp Schematics
Pole	Model	Normal	Down	Normal	Down	Notes: Switch is marked with NO, NC, C, L. LED circuit is isolated and requires external power source.
SP	HB15 *HB16	ON ON	(ON) ON	1-3	1-2	SPDT  

\* When in latched position for the alternate circuit, cap position is .051" (1.3mm) above the built-in bezel.

## SHAPES & PANEL CUTOUT

**S**

.354" (9.0mm) Square

The bezel is an integral part of the switch body.

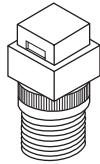

**C**

.354" (9.0mm) Round

The bezel is an integral part of the switch body.

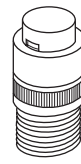

### Panel Cutout & Mounting

Recommended Panel Thickness:  
.020 ~ .197" (0.5 ~ 5.0mm)

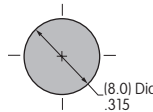

Overtightening the mounting nut AT073 may damage the switch housing.

## HOUSING

**K**

Housing available in black only.

## CONTACT MATERIALS, RATINGS, & TERMINALS

**W01**

Silver Contacts

Power Level

0.1A maximum @ 30V AC/DC

Solder Lug

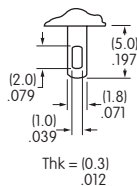

PCB Mounting

Solder lug terminals are spaced .100" x .200" (2.54mm x 5.08mm). This enables PCB mounting which can be accomplished by elongating PC board holes to .080" (2.03mm).

## LED COLORS & SPECIFICATIONS

The electrical specifications shown are determined at a basic temperature of 25°C.  
 LED circuit is isolated and requires external power source. Single element LED is colored in OFF state.  
 If the source voltage exceeds the rated voltage, a ballast resistor is required.  
 The resistor value can be calculated by using the formula in the Supplement section.

Bright AT633	Note for Super Bright: 	Color	Bright			Super Bright			Unit
			5C	5D	5F	6B	6F	6G	
Super Bright AT624G Blue AT629B White AT630F Green	Maximum Forward Current	$I_{FM}$	30	30	30	30	30	30	mA
	Typical Forward Current	$I_F$	20	20	20	20	20	20	mA
	Forward Voltage	$V_F$	1.95	2.0	2.1	3.3	3.3	3.3	V
	Maximum Reverse Voltage	$V_{RM}$	5	5	5	7	7	7	V
	Current Reduction Rate Above 25°C	$\Delta I_F$	0.42	0.42	0.42	0.40	0.40	0.40	mA/°C
	T-1 Bi-pin	Ambient Temperature Range		-25° ~ +50°C			-25° ~ +50°C		

**No Code**

No Lamp

## CAP TYPES & COLORS

Color Codes: A Black B White C Red D Amber E Yellow F Green G Blue J Clear

Cap Colors Available:

**AB** Black Cap with Translucent White Window for LED Display

Colored Cap for Bright LEDs

Square only  
 Material: Polycarbonate  
 Finish: Matte

**AT4052**  
 Spot Illuminated

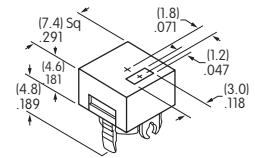

Lens/Diffuser Colors Available:

**CB** Red/White

**DB** Amber/White

**FB** Green/White

**AT4166**  
 Square

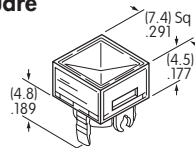

**AT4167**  
 Round

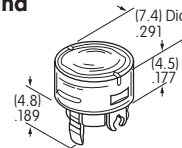

Material: Polycarbonate Finish: Glossy

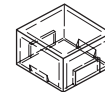

Transparent Colored Lens



Translucent White Diffuser



Colored LED AT633

White Cap for Bright & Super Bright LEDs

**JB** Clear Lens/White Diffuser

**AT4031**  
 Square

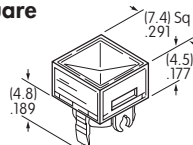

**AT4032**  
 Round

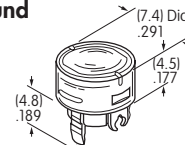

Material: Polycarbonate  
 Finish: Glossy

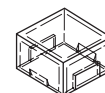

Transparent Clear Lens



Translucent White Diffuser



Colored LEDs AT624, AT629, AT630, or AT633

Nonilluminated Caps

Cap Colors Available:

**A** Black (Square Only)

**B** White

**C** Red

**E** Yellow

**F** Green

**G** Blue

Material: Polycarbonate Finish: Glossy

**AT4035**  
 Square

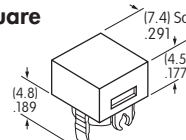

**AT4036**  
 Round

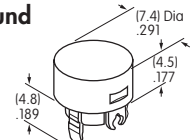

## TYPICAL SWITCH DIMENSIONS

### Single Pole

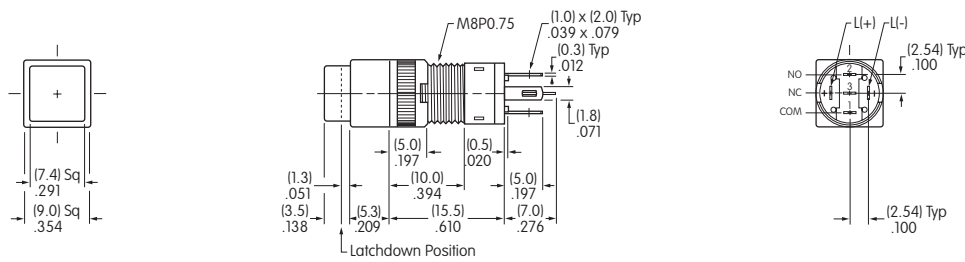

### Square



HB15SKW01-5C-CB

### Single Pole

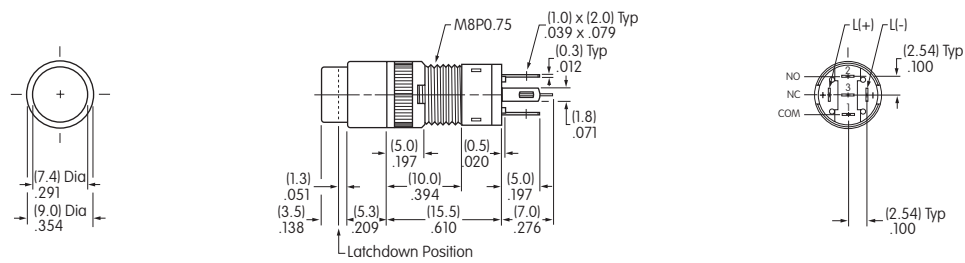

### Round



HB16CKW01-5C-CB

## ASSEMBLY INSTRUCTIONS

### Cap Removal

1. Have cap in extended position (not latchdown) for alternate action models.
2. Use the grip slots on the sides of the cap and pull it out of the switch.

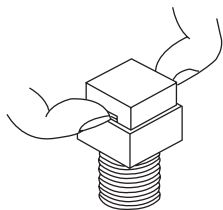

### LED Polarity & Orientation in Lamp Socket

For AT624, AT629, AT630: Insert the LED with the D flat opposite the black dot molded inside the switch lamp socket. For AT633: Insert the LED with the Black Dot on the terminal to the right.

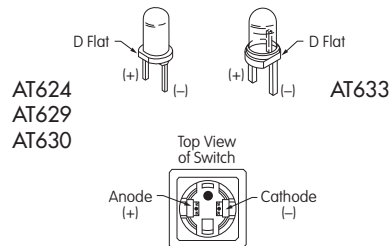

Super Bright LEDs AT624, AT629, & AT630 are electrostatic sensitive.

### Cap Replacement

1. Match the prongs on the cap base with the projections in the switch, at the same time aligning the spring clips on the cap with the indentations in the switch.
2. Press firmly in place.

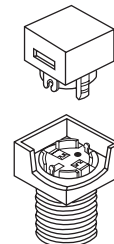

### AT111 Lamping Tool

Lamping Tool AT111 may be used to remove and replace LED.



### AT110 Socket Wrench

Socket Wrench AT110 may be used to tighten the mounting nut.



# General Specifications

## Electrical Capacity (Resistive Load)

**Logic Level (gold):** 0.4VA maximum @ 28V AC/DC maximum  
 (Applicable Range 0.1mA ~ 0.1A @ 20mV ~ 28V)  
 Note: Find additional explanation of operating range in Supplement section.

## Other Ratings

**Contact Resistance:** 80 milliohms maximum  
**Insulation Resistance:** 500 megohms minimum @ 500V DC  
**Dielectric Strength:** 500V AC minimum for 1 minute minimum  
**Mechanical Life:** 100,000 operations minimum for momentary;  
**Electrical Life:** 100,000 operations minimum  
**Nominal Operating Force:** 1.8N  
**Travel:** Pretravel .051" (1.3mm); Overtravel .020" (0.5mm); Total Travel .071" (1.8mm)

## Materials & Finishes

**Housing:** Glass fiber reinforced polyamide  
**Base:** Glass fiber reinforced polyamide  
**Movable Contact:** Phosphor bronze with gold plating  
**Switch Terminals:** Phosphor bronze with gold plating  
**Lamp Terminals:** Steel with silver plating

## Environmental Data

**Operating Temperature Range:** -25°C through +50°C (-13°F through +122°F)  
**Humidity:** 90 ~ 95% humidity for 240 hours @ 40°C (104°F)  
**Vibration:** 10 ~ 55Hz with peak-to-peak amplitude of 1.5mm traversing the frequency range & returning in 1 minute; 3 right angled directions for 2 hours  
**Shock:** 50G (490m/s<sup>2</sup>) acceleration (tested in 6 right angled directions, with 5 shocks in each direction)

## Installation

**Cap Installation Force:** 15.0N (3.37 lbf) maximum downward force on cap

## PCB Processing

**Soldering:** Wave Soldering: See Profile A in Supplement section.  
 Manual Soldering: See Profile B in Supplement section.  
**Cleaning:** These devices are not process sealed. Hand clean locally using alcohol based solution.

## Standards & Certifications

The HB2 pushbuttons have not been tested for UL recognition or CSA certification. These switches are designed for use in a low-voltage, low-current, logic-level circuit. When used as intended in a logic-level circuit, the results do not produce hazardous energy.

# Distinctive Characteristics

Quiet actuation combined with crisp tactile feedback suited for broadcast equipment.

Full face illumination with choice of red/green or red/yellow bicolor LEDs, as well as simultaneous bicolor illumination which produces amber.

Option of legends on caps or film insert.

Compact design with short body .669" (17.0mm) from PCB to top of cap and .295" (7.5mm) square cap.

Sliding Twin Crossbar (STC) mechanism provides unequalled logic-level reliability, contact stability, smooth positive detent actuation, and long life.

Crimped power terminals ensure secure PCB mounting and prevent dislodging during soldering.

Suitable applications include broadcast, telecommunication, and medical equipment, as well as measuring instruments, etc.

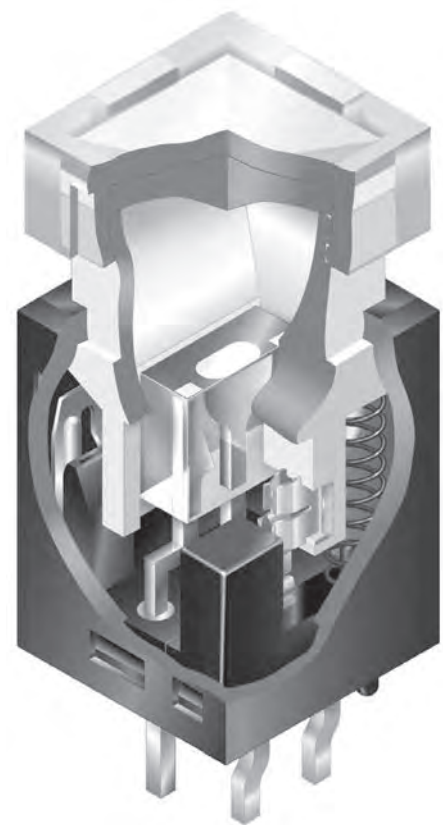

Actual Size

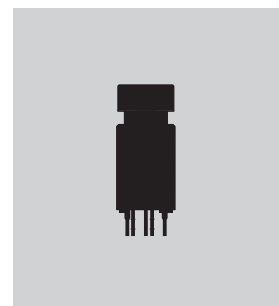

- Toggle
- Rockers
- Pushbuttons
- D Illuminated PB**
- Programmable
- Keylocks
- Rotaries
- Slides
- Tactiles
- Tilt
- Touch
- Indicators
- Accessories
- Supplement

### TYPICAL SWITCH ORDERING EXAMPLE

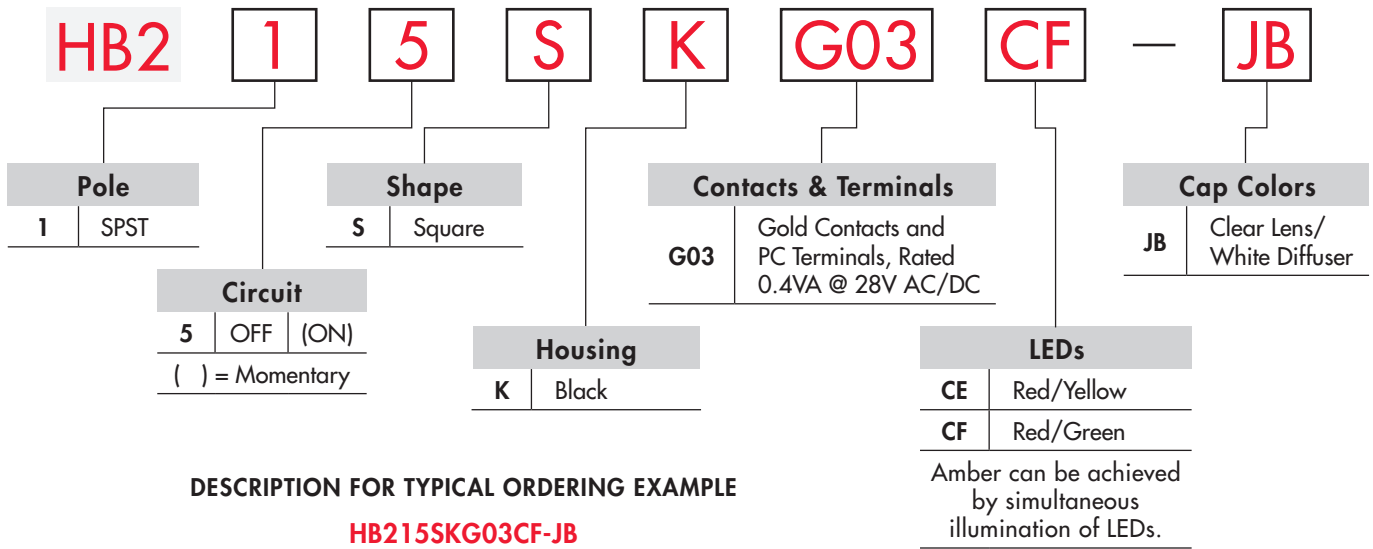

### DESCRIPTION FOR TYPICAL ORDERING EXAMPLE

**HB215SKG03CF-JB**

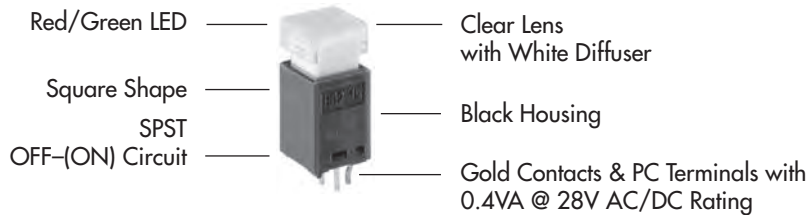

### POLE & CIRCUIT

Pole	Model	Plunger Position ( ) = Momentary		Connected Terminals		Throw & Switch/Lamp Schematics
		Normal	Down	Normal	Down	
SP	HB215	OFF	(ON)	OPEN	1-2	SPST

Notes: Switch terminals are not marked on the switch. Red LED terminal is marked with "R". Lamp circuit is isolated and requires external power source.

### HOUSING SHAPE & COLOR

**S** .307" (7.8mm) Square Body

**K** Black Housing

### CONTACT MATERIALS, RATINGS & TERMINALS

**G03** Gold Contacts Logic Level 0.4VA maximum @ 28V AC/DC maximum

Switch Terminal

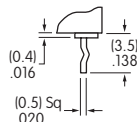

Lamp Terminal

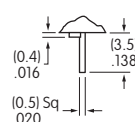

PCB Footprint

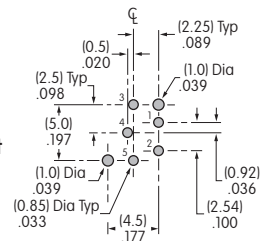

## BICOLOR LEDES & SPECIFICATIONS

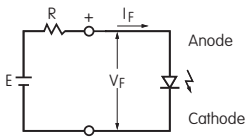

$$R = \frac{E - V_F}{I_F}$$

Where: R = Resistor Value (Ohms)  
 E = Source Voltage (V)  
 V<sub>F</sub> = Forward Voltage (V)  
 I<sub>F</sub> = Forward Current (A)

LED is an integral part of the switch.

Color	CE		CF	
	Red	Yellow	Red	Green
Maximum Forward Current	I <sub>FM</sub> * 30mA	* 30mA	* 30mA	* 30mA
Typical Forward Current	I <sub>F</sub> 20mA	20mA	20mA	20mA
Forward Voltage	V <sub>F</sub> 2.0V	2.1V	2.0V	2.1V
Maximum Reverse Voltage	V <sub>RM</sub> 4V	4V	4V	4V
Current Reduction Rate Above 25°C	ΔI <sub>F</sub> 0.33mA/°C	0.33mA/°C	0.33mA/°C	0.33mA/°C
Ambient Temperature Range	-25° ~ +50°C			

The electrical specifications shown are determined at a basic temperature of 25°C. LED circuit is isolated and requires an external power source. If the source voltage exceeds the rated voltage, a ballast resistor is required. The resistor value can be calculated by using the formula in the Supplement section.

\* Value applies to single color illumination for either Red or Yellow or Red or Green. When both colors are illuminated simultaneously, the sum of the currents should not exceed the smallest value of the maximum forward current.

## CAP COLORS



**Clear Transparent Lens**

**AT3081**  
**Square Lens**

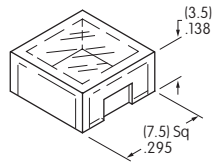

**White Translucent Diffuser**

**AT3082**  
**Square Diffuser**

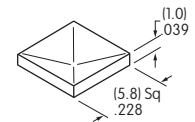

Lens & Diffuser Material: Polycarbonate    Lens Finish: Glossy    Diffuser Finish: Frosted

## TYPICAL SWITCH DIMENSIONS

### Single Pole

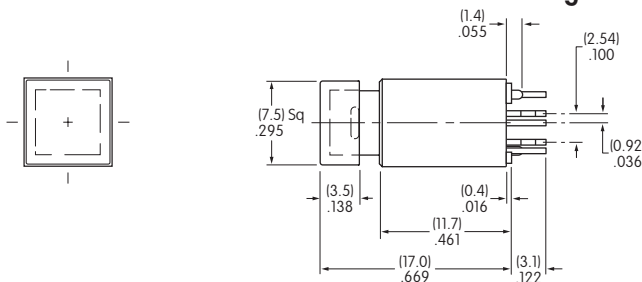

### Square

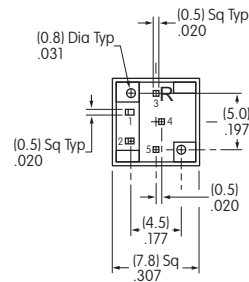

**HB215SKG03CF-JB**

## LEGENDS

NKK Switches can provide custom legends for caps. Contact factory for more information.

### Suggested Printable Area for HB2 Lens & Film Insert

**Recommended Methods:** Screen Print or Pad Print on Lens; Laser Print on Film Insert.  
 Epoxy based ink is recommended. Film Insert: Clear Polyester, 4 mil max. thickness

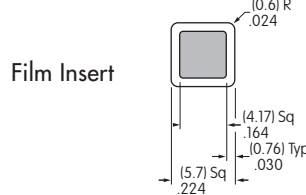
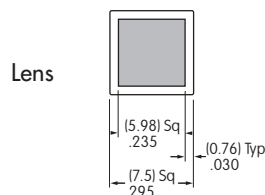
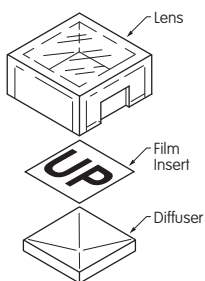

Shaded areas are printable areas.

# General Specifications

## Electrical Capacity (Resistive Load)

<b>Power Level (silver):</b>	1A @ 125/250V AC or 1A @ 30V DC
<b>Logic Level (gold):</b>	0.4VA maximum @ 28V AC/DC maximum (Applicable Range 0.1mA ~ 0.1A @ 20mV ~ 28V)

Note: Find additional explanation of operating range in Supplement section.

## Other Ratings

<b>Contact Resistance:</b>	50 milliohms maximum
<b>Insulation Resistance:</b>	1,000 megohms minimum @ 500V DC
<b>Dielectric Strength:</b>	For Silver: 1,000V AC minimum between contacts for 1 minute minimum & 1,500V AC minimum between contacts & case for 1 minute minimum; For Gold: 750V AC minimum between contacts for 1 minute minimum & 1,500V AC minimum between contacts & case for 1 minute minimum
<b>Mechanical Life:</b>	100,000 operations minimum
<b>Electrical Life:</b>	50,000 operations minimum for silver; 100,000 operations minimum for gold
<b>Nominal Operating Force:</b>	Single pole 0.98 ~ 2.45N for maintained & 0.98 ~ 1.96N for momentary; Double pole 1.47 ~ 3.43N for maintained & 1.47 ~ 2.94N for momentary
<b>Contact Timing:</b>	Nonshorting (break-before-make)
<b>Travel:</b>	Pretravel .087" (2.2mm); Overtravel .031" (0.8mm); Total Travel .118" (3.0mm)

## Materials & Finishes

<b>Housing:</b>	Polyamide (UL94V-0)
<b>Movable Contactor:</b>	Silver for power circuit; copper with gold plating for logic level circuit
<b>Stationary Contacts:</b>	Silver for power circuit; copper with gold plating for logic level circuit
<b>Housing Base:</b>	Polyamide (UL94V-0)
<b>Terminal Base:</b>	Polyester
<b>Common Terminals:</b>	Phosphor bronze with silver flash plating for power circuit; Phosphor bronze with gold flash plating for logic level circuit
<b>End Terminals:</b>	Brass with silver flash plating for power circuit; Brass with gold flash plating for logic level circuit
<b>Lamp Terminals:</b>	Phosphor bronze with nickel flash plating

## Environmental Data

<b>Operating Temperature Range:</b>	-25°C through +50°C (-13°F through +122°F) for Illuminated -25°C through +70°C (-13°F through +158°F) for Nonilluminated
<b>Humidity:</b>	90 ~ 95% humidity for 96 hours @ 40°C (104°F)
<b>Vibration:</b>	10 ~ 55Hz with peak-to-peak amplitude of 1.5mm traversing the frequency range & returning in 1 minute; 3 right angled directions for 2 hours
<b>Shock:</b>	50G (490m/s <sup>2</sup> ) acceleration (tested in 6 right angled directions, with 3 shocks in each direction)

## Installation

<b>Mounting Torque:</b>	0.78Nm (6.9 lb•in) maximum
<b>Cap Installation Force:</b>	4.51N (1.0 lbf) maximum downward force on cap
<b>Soldering Time &amp; Temperature:</b>	Manual Soldering: See Profile A in Supplement section.

## Standards & Certifications

<b>Flammability Standards:</b>	UL94V-0 housing & housing base
<b>UL:</b>	<b>File No. E44145 - Recognized only when ordered with marking on switch.</b> Add "/U" or "/CUL" before first dash in part number to order UL recognized switch. Single & double pole models recognized at 1A @ 125/250V AC, 1A @ 30V DC, & 0.4VA @ 28V DC.
<b>CSA:</b>	<b>File No. 023535_0_000 - Certified only when ordered with marking on switch.</b> Add "/C" before first dash in part number to order CSA certified switch. Single & double pole models recognized at 1A @ 125/250V AC, 1A @ 30V DC, & 0.4VA @ 28V DC.



# Distinctive Characteristics

Bright illumination with numerous color variations. Spot illumination available. Square, rectangular, and round shaped caps.

Front panel relamping.

Choice of bright or super bright LEDs in red, amber, green, white, and blue.

Latchdown feature gives indication of circuit status. Audible and tactile feedback with smooth and responsive operation.

Snap-action mechanism for long life.

Stainless steel frame on snap-in models has a specially designed projection, which prevents rotation and correctly orients switch in panel.

12mm body diameter.

Molded-in terminals lock out flux, dust, and other contaminants.

8mm panel thickness capability. Rear panel bushing or snap-in mounting.

Optional PCB adaptors in straight and right angle types.

Matching indicators available.

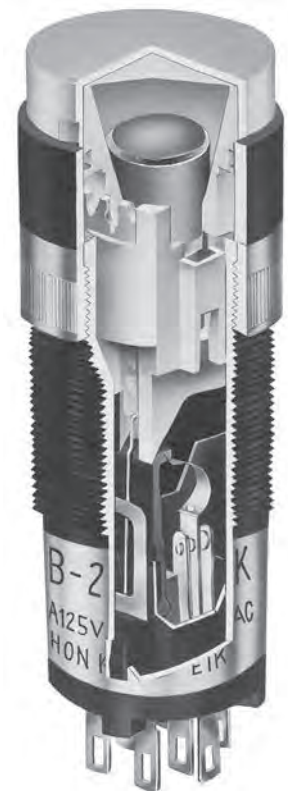

Actual Size

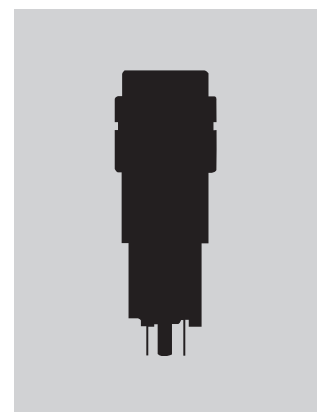

- Toggle
- Rockers
- Pushbuttons
- Illuminated PB**
- Programmable
- Key locks
- Rotaries
- Slides
- Tactiles
- Tilt
- Touch
- Indicators
- Accessories
- Supplement

### TYPICAL SWITCH

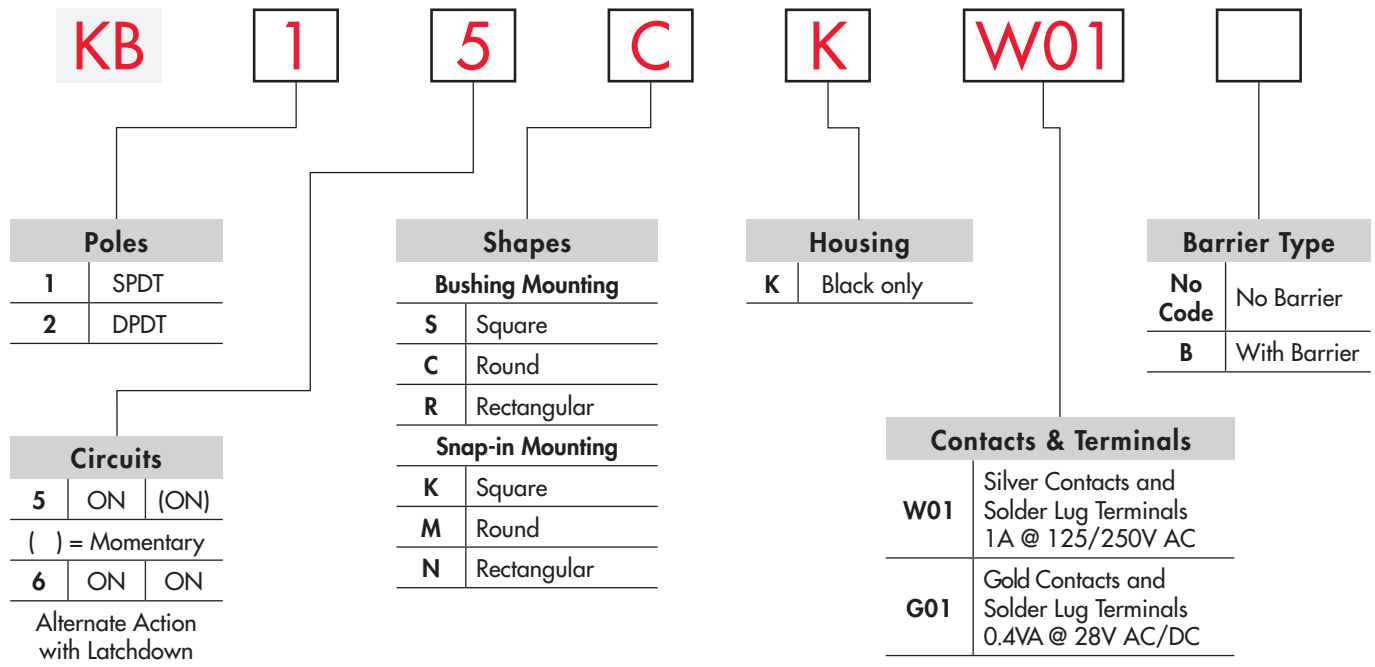

#### IMPORTANT:



Switches are supplied without UL, cULus & CSA marking unless specified.  
**UL, cULus & CSA recognized only when ordered with marking on the switch.**  
 Specific models, ratings, & ordering instructions are noted on the General Specifications page.

#### DESCRIPTION FOR TYPICAL ORDERING EXAMPLE

#### KB15CKW01-12-FF



## ORDERING EXAMPLE

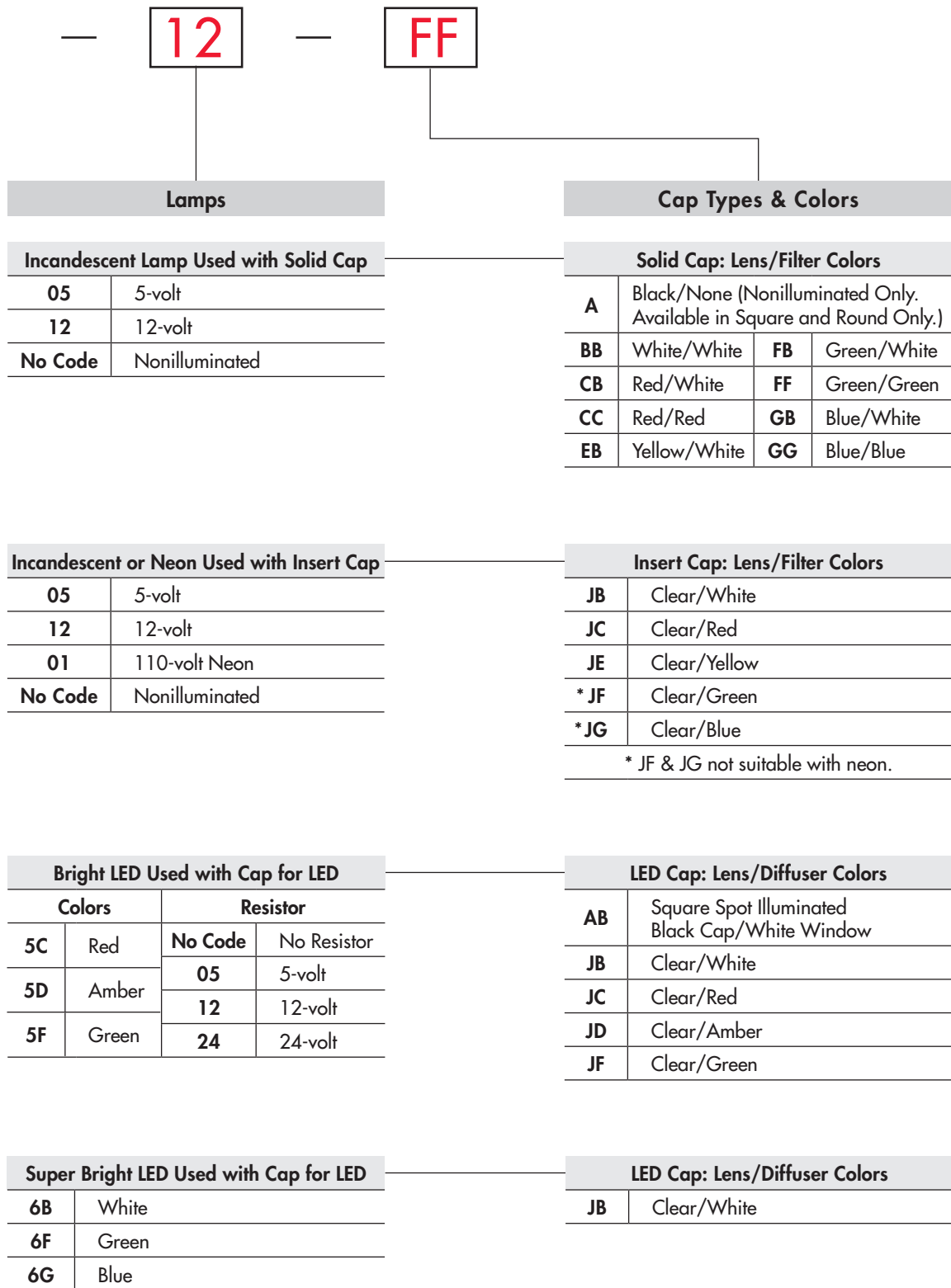

## POLES & CIRCUITS

Pole	Model	Plunger Position ( ) = Momentary		Connected Terminals		Throw & Switch/Lamp Schematics
		Normal	Down	Normal	Down	
SP	KB15 *KB16	ON ON	(ON) ON	2-3	2-1	Notes: Switch is marked with "+" and "-". Lamp circuit is isolated and requires external power source. SPDT
DP	KB25 *KB26	ON ON	(ON) ON	2-3 5-6	2-1 5-4	DPDT

\* When in latched position for the alternate circuit, cap position is .055" (1.4mm) above the built-in bezel.

## MOUNTING TYPES & SHAPES

### Bushing Mounting

**S** .551" (14.0mm)  
Square

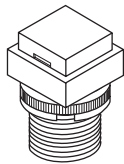

No barrier

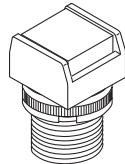

With barrier

**C** .551" (14.0mm)  
Round

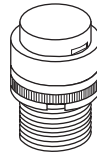

**R** .551" x .728" (14.0mm x 18.5mm)  
Rectangular

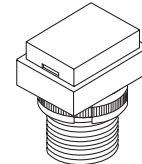

No barrier

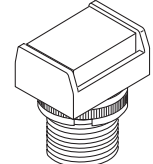

With barrier

Bezel or barrier is an integral part of the switch body. One mounting nut AT057 supplied with each switch.

### Snap-in Mounting

**K** .551" (14.0mm)  
Square

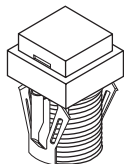

No barrier

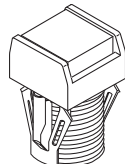

With barrier

**M** .551" (14.0mm)  
Round

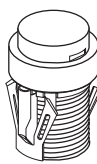

**N** .551" x .728" (14.0mm x 18.5mm)  
Rectangular

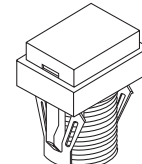

No barrier

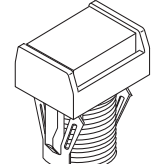

With barrier

Bezel or barrier is an integral part of the switch body.

### Panel Cutouts

#### Bushing Mounting

Without  
Keyway

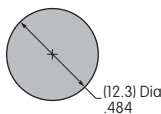

Panel Thickness:  
.020" ~ .315"  
(0.5 ~ 8.0mm)

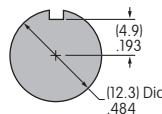

With  
Keyway

#### Snap-in Mounting

Panel Thickness:  
.039" ~ .138"  
(1.0 ~ 3.5mm)

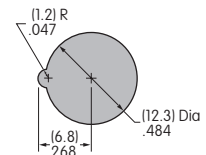

Panel thicknesses, when using optional accessories, are shown with the accessories at the end of this KB section.

## HOUSING

**K** Housing available in black only. Bezel or barrier is an integral part of the switch body.

## CONTACT MATERIALS, RATINGS & TERMINALS

**W**

Silver Contacts

**Power Level**  
1A @ 125V AC & 250V AC

**01**

Solder Lug

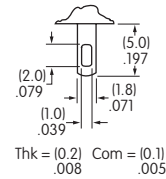

**G**

Gold Contacts

**Logic Level**  
0.4VA maximum @ 28V AC/DC

Complete explanation of operating range in Supplement section.

### AT055 Crossover Guard

A partitioned plastic guard is supplied with each switch to provide insulation between terminals.

Installation steps:

1. Identify wire-to-terminal connections.
2. Thread wires through the guard.
3. Solder the connections.
4. Push the guard fully onto the switch body.

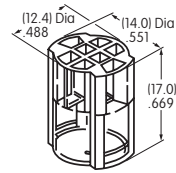

## BARRIER TYPE

**No Code**

No Barrier

Built-in bezel

**B**

With Barrier

Built-in barrier only available for Square and Rectangular

## LAMP COLORS & SPECIFICATIONS



The electrical specifications shown are determined at a basic temperature of 25°C. LED circuit is isolated and requires external power source. Polarity marks are on the bottom of the switch.

If the source voltage exceeds the rated voltage, a ballast resistor is required.

The resistor value can be calculated by using the formula in the Supplement section.

Ambient Temperature Range for lamps below: -25°C ~ +50°C.

### Incandescent & Neon Lamps

AT611 Incandescent	AT615 Neon		<b>05</b>	<b>12</b>	<b>01</b>	Recommended Resistors for Neon: 33K ohms for 110V AC; 100K ohms for 220V AC	
		Voltage	V	5V AC	12V AC		110V AC
		Current	I	115mA	60mA		1.5mA
		Endurance	Hours	7,000 average			10,000

**No Code**

No Lamp

### Bright LED with Resistor

AT634	Color Codes:	Red	Amber	Green	Resistor Codes		
		<b>5C</b>	<b>5D</b>	<b>5F</b>	<b>05</b>	<b>12</b>	<b>24</b>
LEDs are colored in OFF state.							
							
T-1 1/4 Bi-pin							
	Maximum Forward Current			$I_{FM}$	—	—	—
	Typical Forward Current			$I_F$	25mA	20mA	10mA
	Forward Voltage			$V_F$	5V	12V	24V
	Maximum Reverse Voltage			$V_{RM}$	4V	8V	16V
	Current Reduction Rate Above 25°C			$\Delta I_F$	—	—	—

AT634  
5-volt  
2-element  
with 1 Resistor

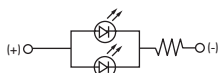

AT634  
12-volt  
4-element  
with 2 Resistors

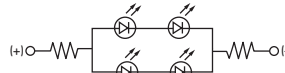

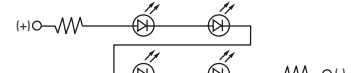

AT634  
24-volt  
4-element  
with 2 Resistors





## LAMP COLORS & SPECIFICATIONS

### Bright LED without Resistor

<b>AT635</b> LEDs are colored in OFF state.   T-1 1/2 Bi-pin	Red <b>5C</b>	Amber <b>5D</b>	Green <b>5F</b>	<b>No Code</b> No Resistor		
	Color Codes			Red	Amber	Green
	Maximum Forward Current			30mA	30mA	30mA
	Typical Forward Current			20mA	20mA	20mA
	Forward Voltage			1.9V	2.0V	2.1V
	Maximum Reverse Voltage			5V	5V	5V
	Current Reduction Rate Above 25°C			0.42mA/°C		
	Ambient Temperature Range			-25° ~ +50°C		

### Super Bright Single Element LED

<b>AT625G Blue</b> <b>AT631B White</b> <b>AT632F Green</b>   T-1 Bi-pin	 <b>ATTENTION</b> ELECTROSTATIC SENSITIVE DEVICES			<b>6B</b>	<b>6F</b>	<b>6G</b>
	Color	White	Green	Blue		
	Maximum Forward Current			30mA	30mA	30mA
	Typical Forward Current			20mA	20mA	20mA
	Forward Voltage			3.3V	3.3V	3.3V
	Maximum Reverse Voltage			7V	7V	7V
	Current Reduction Rate Above 25°C			0.40mA/°C	0.40mA/°C	0.40mA/°C
	Ambient Temperature Range			-25° ~ +50°C		

## CAP TYPES & COLOR COMBINATIONS

Color Codes: **A** Black    **B** White    **C** Red    **E** Yellow    **F** Green    **G** Blue    **J** Clear

### Solid Cap for Incandescent Lamp & Nonilluminated

#### Lens/Filter Colors Available:

**A**

Nonilluminated Only;  
Square & Round Only

**BB**

**FB**

**CB**

**FF**

**CC**

**GB**

**EB**

**GG**

**AT485**  
Square

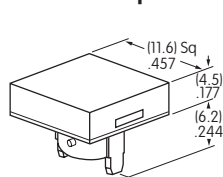

**AT486**  
Round

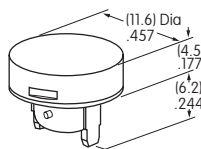

**AT4021**  
Rectangular

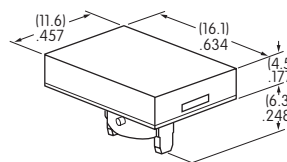

Material: Polycarbonate    Finish: Glossy

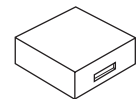

Translucent Colored Lens



Translucent Colored Filter



Lamp AT611

### Insert Cap for Incandescent or Neon Lamp & Nonilluminated

#### Lens/Filter Colors Available:

**JB**

**JF**

**JC**

**JG**

**JE**

**AT487**  
Square

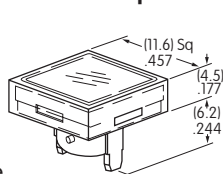

**AT488**  
Round

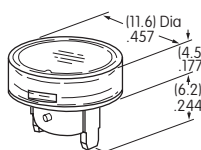

**AT4022**  
Rectangular

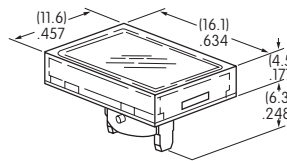

Material: Polycarbonate    Finish: Glossy



Transparent Clear Lens



Translucent Colored Filter



Lamp AT611    Lamp AT615

JF and JG not suitable with neon lamp.

## CAP TYPES & COLOR COMBINATIONS

Color Codes: **A** Black   **B** White   **C** Red   **D** Amber   **E** Yellow   **F** Green   **G** Blue   **J** Clear

### Spot Illuminated Cap for Bright LED without Resistor or with Resistor

Cap/Window Colors Available:

**AB**

Opaque Black Cap with Translucent White Window for Spot Illumination

**AT4051**  
Square

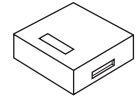
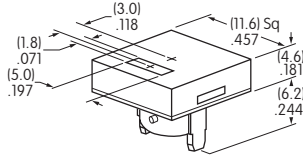

Bright LED  
AT635

Bright LED  
AT634

Material: Polycarbonate   Finish: Matte

### Cap for Bright LED without Resistor or LED with Resistor

Lens/Diffuser Colors Available: (AT4133, 4132, 4134 white diffusers; AT4158, 4160, 4159 colored diffusers)

**JB**

**AT4133**

Square

**AT4132**

Round

**AT4134**

Rectangular



Transparent Clear Lens

**JC**

**AT4158**

**AT4160**

**AT4159**



Translucent Diffuser

**JD**

**JF**

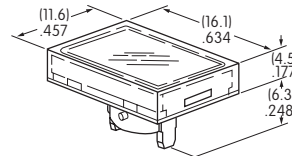
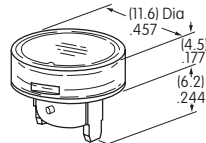
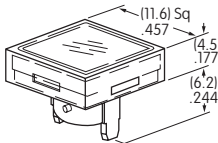

Bright LED  
AT635

Bright LED  
AT634

Material: Polycarbonate   Finish: Glossy

### Cap for Super Bright LED

Lens/Diffuser Colors Available:

**JB**

**AT4133**  
Square

**AT4132**  
Round

**AT4134**  
Rectangular

Translucent Clear Lens

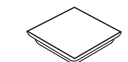

Translucent White Diffuser

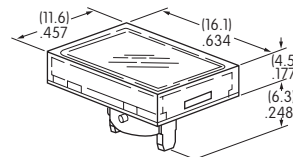
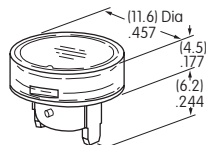
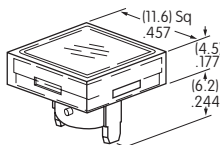

Super Bright LEDs  
AT625  
AT631 AT632

Material: Polycarbonate   Finish: Glossy

## TYPICAL SWITCH DIMENSIONS

### Square • Bushing Mount

### Single & Double Pole

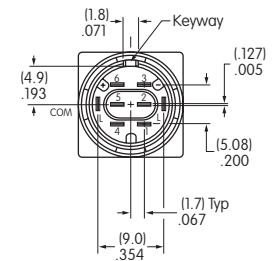
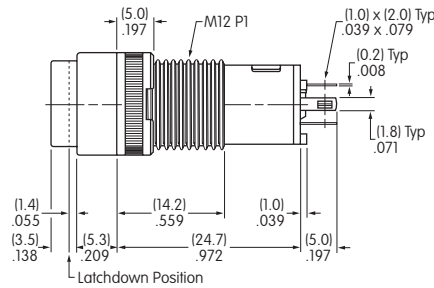
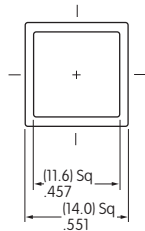

**KB15KW01-05-GG**

Single pole models do not have terminals 4, 5, & 6.

### Round • Bushing Mount

### Single & Double Pole

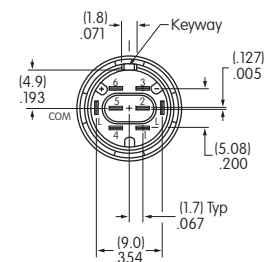
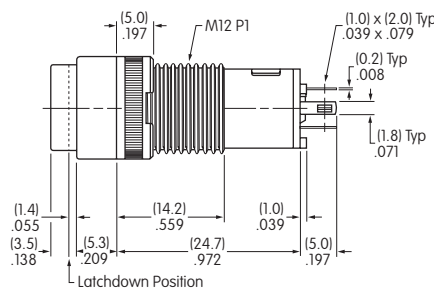
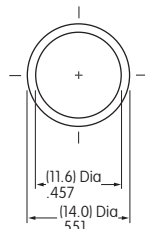

**KB25CKW01-05-GG**

Single pole models do not have terminals 4, 5, & 6.

### Rectangular • Bushing Mount

### Single & Double Pole

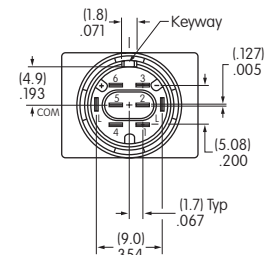
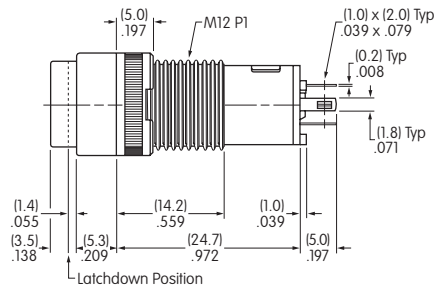
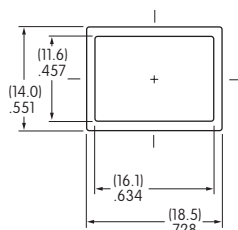

**KB15RKW01-05-GG**

Single pole models do not have terminals 4, 5, & 6.



TYPICAL SWITCH DIMENSIONS

Single & Double Pole

Square • Snap-in Mount

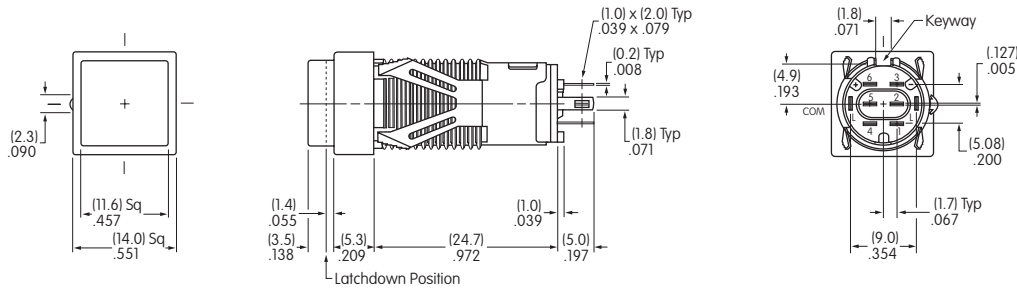

Single pole models do not have terminals 4, 5, & 6.

KB16KKW01-05-CB

Single & Double Pole

Round • Snap-in Mount

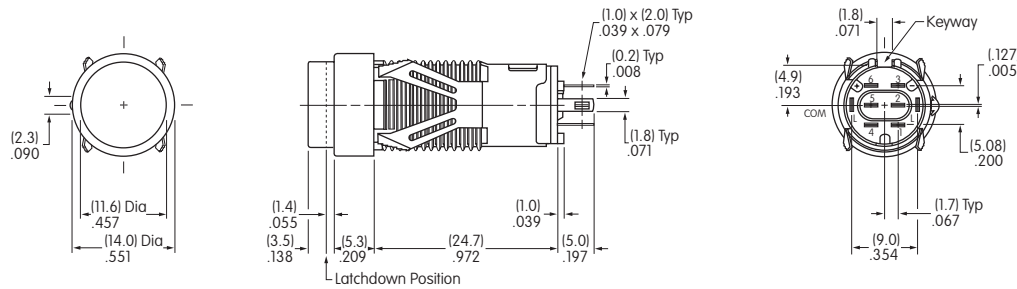

Single pole models do not have terminals 4, 5, & 6.

KB26MKW01-05-CB

Single & Double Pole

Rectangular • Snap-in Mount

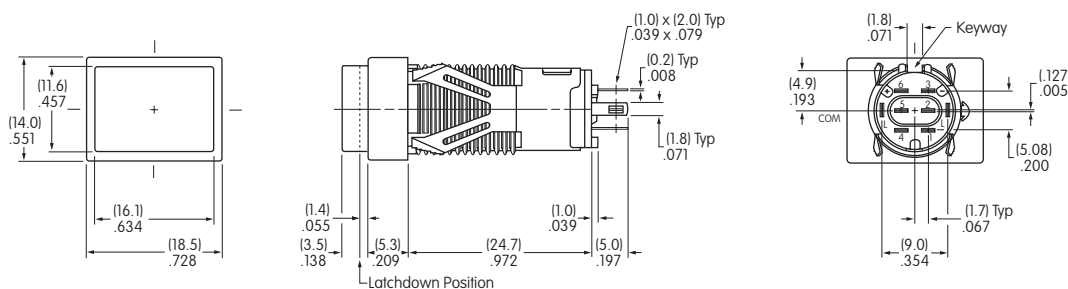

Single pole models do not have terminals 4, 5, & 6.

KB16NKW01-05-CB

## TYPICAL SWITCH DIMENSIONS

### Square • Barrier • Bushing Mount

### Single & Double Pole

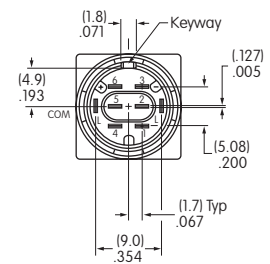
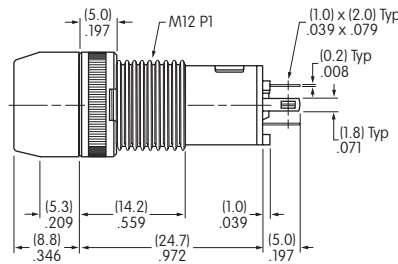
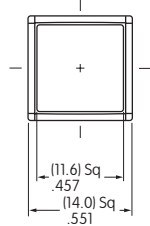

**KB15KW01B-6G-JB**

Single pole models do not have terminals 4, 5, & 6.

### Square • Barrier • Snap-in Mount

### Single & Double Pole

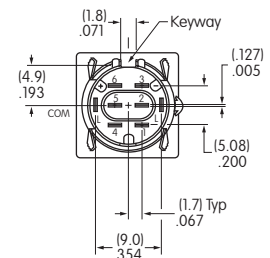
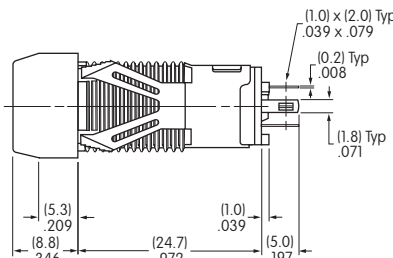
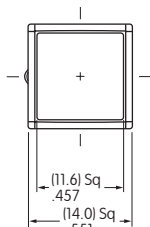

**KB15KKW01B-5C-JC**

Single pole models do not have terminals 4, 5, & 6.

### Rectangular • Barrier • Bushing Mount

### Single & Double Pole

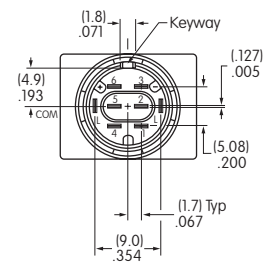
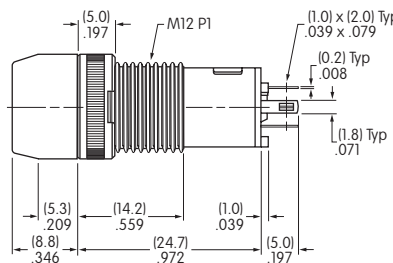
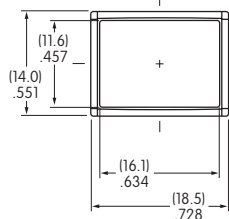

**KB15RKW01B-5F-JF**

Single pole models do not have terminals 4, 5, & 6.

### Rectangular • Barrier • Snap-in Mount

### Single & Double Pole

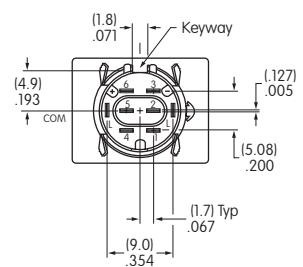
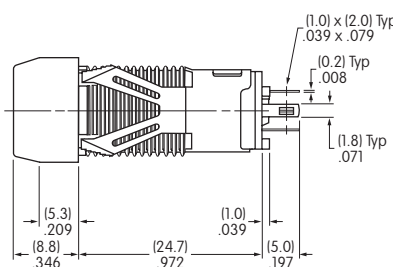
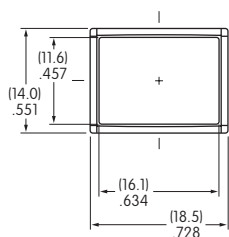

**KB15NKW01B-5D-JD**

Single pole models do not have terminals 4, 5, & 6.

## OPTIONAL ACCESSORIES

### PCB Adaptors

**AT701**  
Single Pole  
Straight PC  
Terminals



**AT702**  
Double Pole  
Straight PC  
Terminals

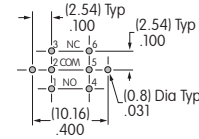
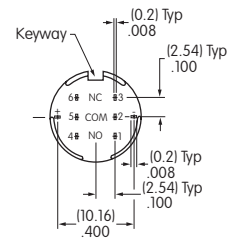
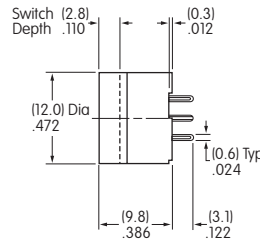
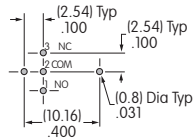
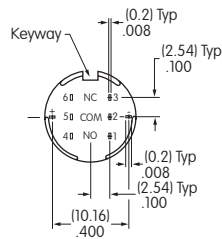
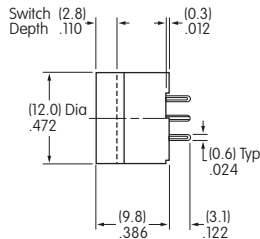

Material: Glass fiber reinforced polyamide Note: Order adaptors separately

### Dust Covers

Panel Thickness Range: .020 ~ .268" (0.5 ~ 6.8mm) for Bushing Mounting; .020 ~ .079" (0.5 ~ 2.0mm) for Snap-in Mounting  
Dust Covers reduce the depth of switch behind panel by .047" (1.2mm).

**AT495**  
For Square & Round  
(not for Barrier type)

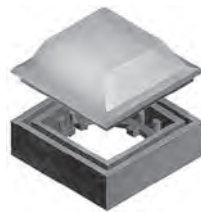

**AT4025**  
For Rectangular  
(not for Barrier type)

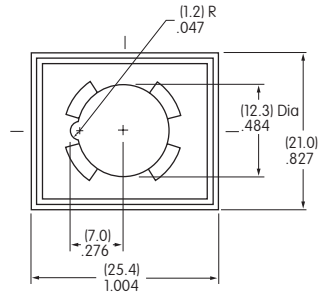
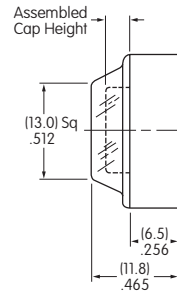
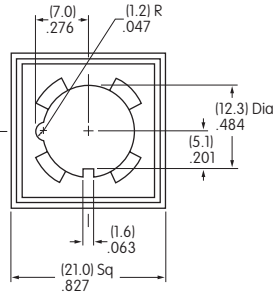
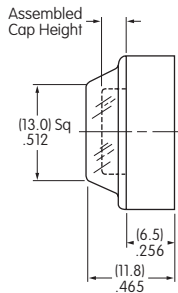

Material: Lid: PVC PVC loses pliability below 0°C (32°F). Base: Polyamide

## OPTIONAL ACCESSORIES

### Protective Guards

**AT494**  
For Square & Round  
(not for Barrier type)



**AT4024**  
For Rectangular  
(not for Barrier type)



Panel Thickness  
Range:

.020" ~ .268"  
(0.5 ~ 6.8mm)  
for Bushing Mounting

.020" ~ .091"  
(0.5 ~ 2.3mm)  
for Snap-in Mounting

Protective Guards reduce  
the depth of switch  
behind panel by  
.047" (1.2mm).

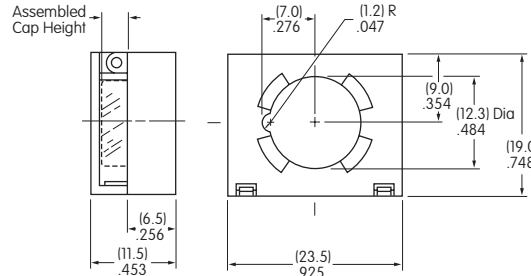
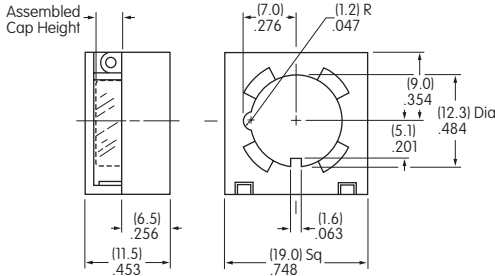

Material: Cover: Polycarbonate

Base: Polyamide

## ASSEMBLY INSTRUCTIONS

### Cap Removal & Installation

For alternate action models cap must be in UP position for cap removal. Indentations on opposite sides of the cap provide an easy way to lift the cap out of the holder, using either the finger nails, or cap extractor AT109.

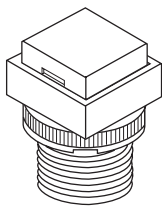

### LED Polarity & Orientation in Lamp Socket

Super Bright LEDs AT625, AT631, & AT632 are electrostatic sensitive.



LED  
AT635



LED  
AT634



LEDs  
AT625  
AT631  
AT632

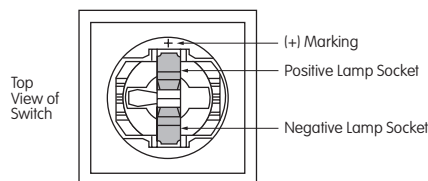
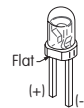

### Cap Replacement

Note that the cap has a pair of round tabs and a pair of long tabs which should be used for correctly replacing the cap in its holder. Using the long tabs as guides, slide the cap with the long tabs moving into the slots on opposite sides of the cap holder. Then, the round tabs will snap into notches on the other two sides of the holder.

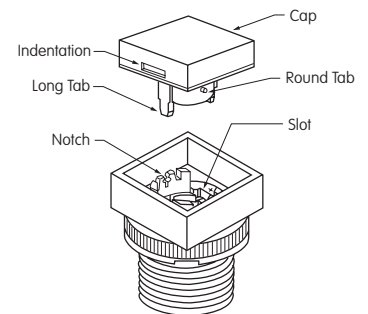

### AT108 Socket Wrench for Bushing Mounting

Overtightening the mounting nut may damage the switch housing.



### AT109 Cap Extractor



### AT111 Lamping Tool



LEGENDS

NKK Switches can provide custom legends for caps. Contact factory for more information.

Suggested Printable Area for KB Lens

Recommended Methods: Screen Print or Pad Print on Lens.  
Epoxy based ink is recommended.

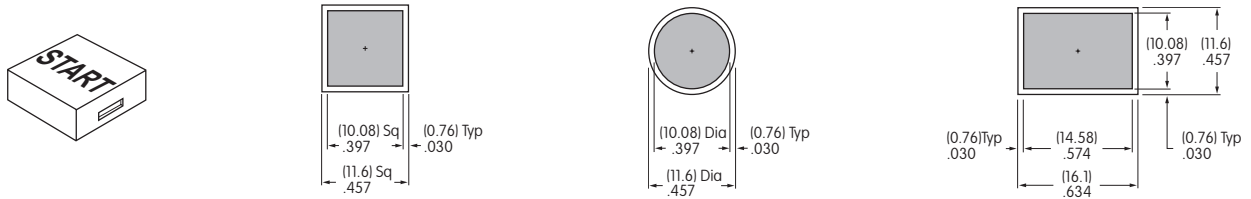

Shaded areas are printable areas.

Suggested Printable Area for Film Insert

Recommended Print Method: Laser Print

Film Insert: Clear Polyester, 4 mil max. thickness

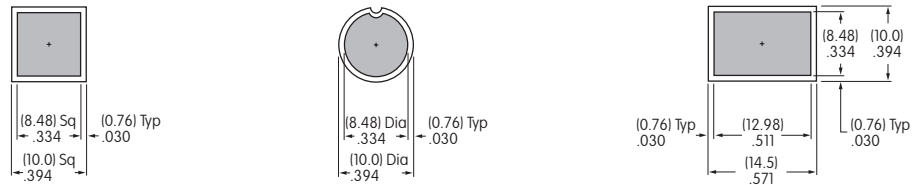
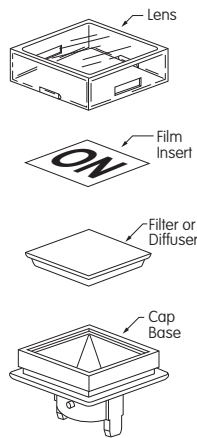

Shaded areas are printable areas.

# General Specifications

## Electrical Capacity (Resistive Load)

**Low Level:** 100mA maximum @ 12V DC

## Other Ratings

**Contact Resistance:** 200 milliohms maximum

**Insulation Resistance:** 100 megohms minimum @ 250V DC

**Dielectric Strength:** 1,000V AC minimum between contacts for 1 minute minimum  
1,500V AC minimum between contacts & case for 1 minute minimum

**Mechanical Life:** 5,000,000 operations minimum;  
1,000,000 operations minimum for custom Rectangular Switch/Cap Assembly (at center of cap)

**Electrical Life:** 5,000,000 operations minimum

**Nominal Operating Force:** **KP01:** 1.9N maximum for Tactile & Nontactile models (at center of cap)

**KP02:** 1.6N maximum for Tactile, Nontactile & Tactile/Audible models (at center of cap)

**Travel:** **KP01:** Pretravel .122" (3.1mm); Overtravel .055" (1.4mm); Total Travel .177" (4.5mm)

**KP02:** Pretravel .091" (2.3mm); Overtravel .047" (1.2mm); Total Travel .138" (3.5mm)

## Materials & Finishes

**Plunger/Upper Housing:** Polyacetal

**Lower Housing:** Glass fiber reinforced PBT (UL94V-0)

**Movable Contact:** Stainless steel with gold plating

**Stationary Contacts:** Gold over copper alloy

**Switch Terminals:** Brass with tin plating

## Environmental Data

**Operating Temperature Range:** -25°C through +50°C (-13°F through +122°F)

**Humidity:** 90-95% humidity for 240 hours @ 40°C (104°F)

**Vibration:** 10 ~ 55Hz with peak-to-peak amplitude of 1.5mm traversing the frequency range & returning in 1 minute; 3 right angled directions for 2 hours

**Shock:** 51G (500m/s<sup>2</sup>) acceleration (tested in 6 right angled directions, with 5 shocks in each direction)

## Installation

**Cap Installation Force :** 50.0N maximum downward force on actuator

## PCB Processing

**Soldering:** Wave Soldering. See Profile A in Supplement section.

Manual Soldering. See Profile A in Supplement section.

**Cleaning:** These devices are not process sealed. Hand clean locally using alcohol based solution.

## Standards & Certifications

**Flammability Standards:** UL94V-0 lower housing

The KP Series pushbuttons have not been tested for UL recognition or CSA certification.

These switches are designed for use in a low-voltage, low-current, logic-level circuit.

When used as intended in a logic-level circuit, the results do not produce hazardous energy.

# Distinctive Characteristics

KP series offers a complete switch solution for all broadcast panel needs, including home keys and the rectangular switch/cap assembly.

Distinct, long total travel of .177" (4.5mm) for KP01 or shorter stroke of .138" (3.5mm) for KP02.

Available with super bright red/green or amber/blue bicolor LED or RGB LED. The RGB LED full color spectrum in a switch package provides unlimited color combinations.

Unique actuation guide gives positive indication of circuit transfer as well as smooth and silent operation.

Choices of tactile, nontactile or tactile/audible actuation.

Compact design with height of .906" (23.0mm) from PC board to top of cap. (Same height as programmable SmartSwitch™.)

Flat, sculptured or home key square caps in three common sizes for design flexibility in audio/video applications.

Twin contacts with gold plating assure high reliability and long life of 5,000,000 operations minimum.

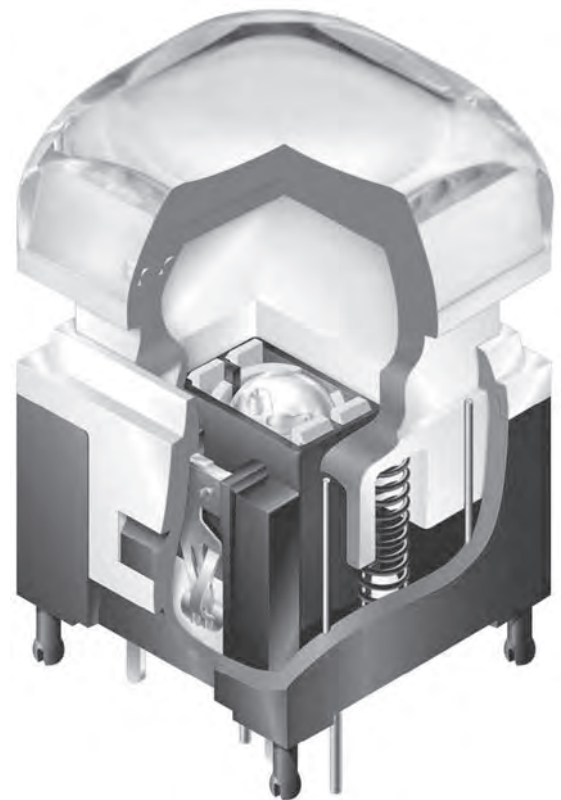

Actual Size

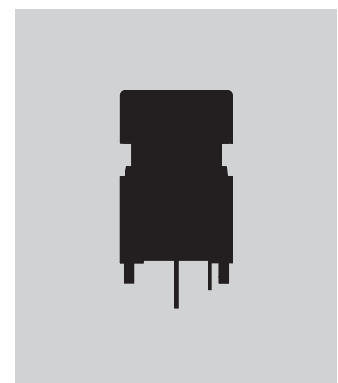

- Toggle
- Rockers
- Pushbuttons
- D Illuminated PB**
- Programmable
- Key locks
- Rotaries
- Slides
- Tactiles
- Tilt
- Touch
- Indicators
- Accessories
- Supplement

Toggles

Rockers

Pushbuttons

Programmable  
Illuminated PB  
D

Keylocks

Rotaries

Slides

Tactiles

Tilt

Touch

Indicators

Accessories

Supplement

**KP**

**01**

**15A**

**N**

**B**

**K**

**G03**

Pole & Circuit			
15A	SPST	OFF	(ON)
( ) = Momentary Normally Open Contacts			

Plungers	
<b>A</b>	9.2mm Plunger for 12.0mm Cap
<b>B</b>	11.6mm Plunger for 15.0mm & 17.4mm Caps

Contacts & Terminals	
<b>G03</b>	Gold Contacts and Straight PC Terminals; 100mA @ 12V DC

Housing	
<b>K</b>	Black only

Travel & Force	
<b>01</b>	Stroke: 4.5mm (.177") Actuation Force: 1.9N
<b>02</b>	Stroke: 3.5mm (.138") Actuation Force: 1.6N

Actuation	
<b>01</b>	
<b>C</b>	Tactile
<b>N</b>	Nontactile
<b>02</b>	
<b>C</b>	Tactile
<b>N</b>	Nontactile
<b>S</b>	Tactile/Audible

#### DESCRIPTION FOR TYPICAL ORDERING EXAMPLE

**KP0115ANBKG036CF-2SJB**



- 11.6mm Plunger and 15.0mm Sculptured Cap  
Clear Lens and White Diffuser
- SPST  
OFF-Momentary ON Circuit  
Normally Open Contacts
- Super Bright Red/Green Bicolor LED
- Nontactile Actuation
- Black Housing
- Gold Contacts with 100mA Rating
- Straight PC Terminals



## ORDERING EXAMPLE

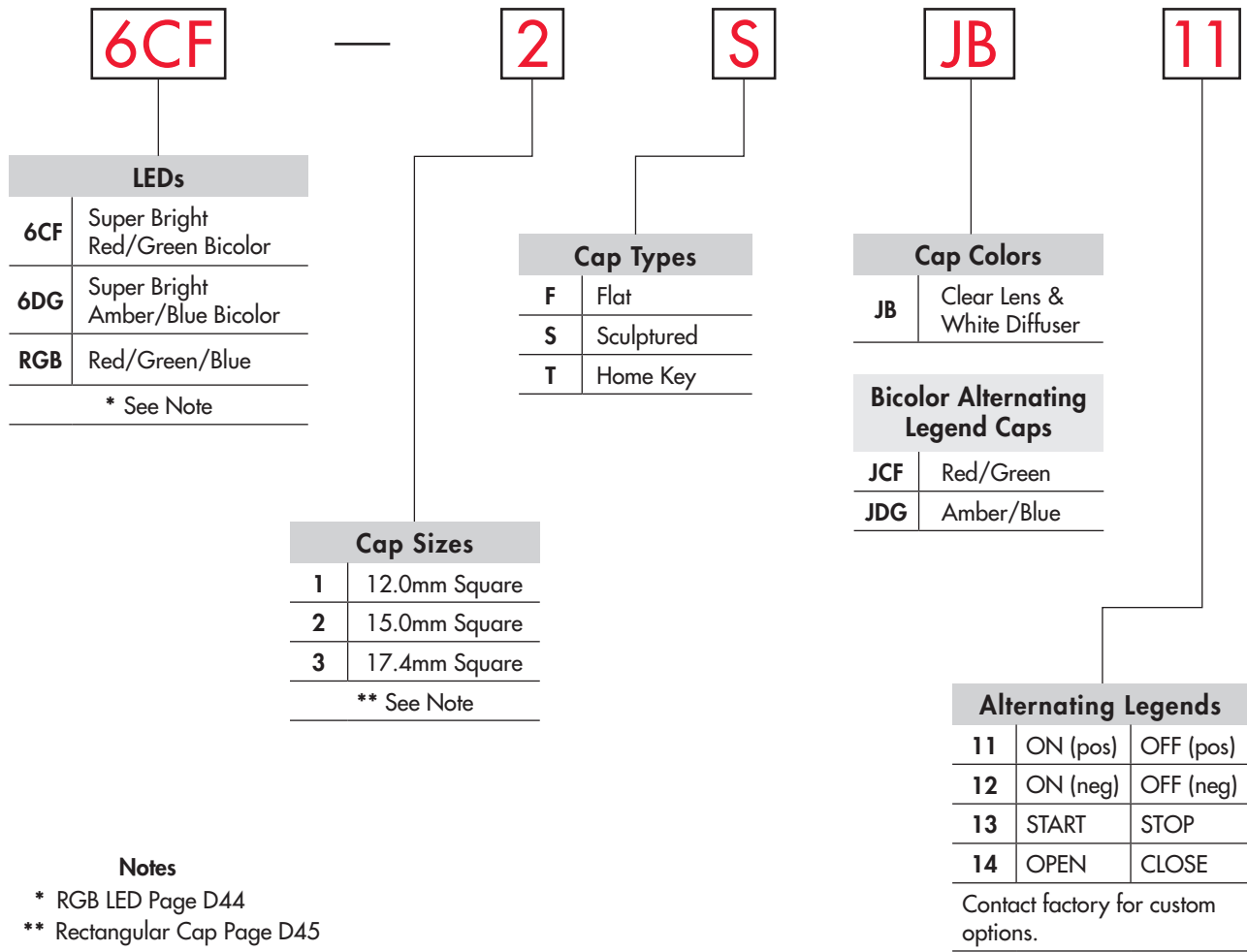

### Notes

- \* RGB LED Page D44
- \*\* Rectangular Cap Page D45

### Part Numbers for Alternating Legends

Color	Cap Size	Flat Cap	Sculptured Cap	Home Key Cap
		Part Number	Part Number	Part Number
Red/Green	12mm Square	AT3093JCF11 ~ AT3093JCF14	AT3090JCF11 ~ AT3090JCF14	AT3096JCF11 ~ AT3096JCF14
	15mm Square	AT3094JCF11 ~ AT3094JCF14	AT3091JCF11 ~ AT3091JCF14	AT3097JCF11 ~ AT3097JCF14
	17.4mm Square	AT3095JCF11 ~ AT3095JCF14	AT3092JCF11 ~ AT3092JCF14	AT3098JCF11 ~ AT3098JCF14
Amber/Blue	12mm Square	AT3093JDG11 ~ AT3093JDG14	AT3090JDG11 ~ AT3090JDG14	AT3096JDG11 ~ AT3096JDG14
	15mm Square	AT3094JDG11 ~ AT3094JDG14	AT3091JDG11 ~ AT3091JDG14	AT3097JDG11 ~ AT3097JDG14
	17.4mm Square	AT3095JDG11 ~ AT3095JDG14	AT3092JDG11 ~ AT3092JDG14	AT3098JDG11 ~ AT3098JDG14

Refer to Ordering Table for Alternating Legend that corresponds with last 2 digits of part number.

Toggles

Rockers

Pushbuttons

Illuminated PB

Programmable

Keylocks

Rotaries

Slides

Tactiles

Tilt

Touch

Indicators

Accessories

Supplement

### POLE & CIRCUIT

Pole	Model	Plunger Position ( ) = Momentary		Connected Terminals		Throw & Switch Schematic
		Normal	Down	Normal	Down	
SP	KP0115A KP0215A	OFF	(ON)	Normally Open	1-1a	Note: Switch terminals "1" & "1a" are actually marked on the switch. 

### ACTUATION

### HOUSING

**C**

**Tactile**  
KP01 or KP02

**N**

**Nontactile**  
KP01 or KP02

**S**

**Tactile/Audible**  
KP02 only

**K**

**Black only**

### CONTACTS, TERMINALS, & RATING

**G03**

**Gold Contacts**

**Straight PC Terminals**

**100mA @ 12V DC**

### SUPER BRIGHT BICOLOR LED SPECIFICATIONS

The electrical specifications shown are determined at a basic temperature of 25°C.

Colors	<b>6CF</b>		<b>6DG</b>		Unit	
	Red	Green	Amber	Blue		
Minimum Luminous Intensity	$I_V$	230	220	204	113	mcd
Standard Luminous Intensity	$I_V$	290	270	340	188	mcd
Maximum Forward Current	$I_{FM}$	30 25 for Amber	25 22 for Amber	30	25	mA
Typical Forward Current	$I_F$	15	5	20	20	mA
Forward Voltage	$V_F$	2.0	3.1	2.1	3.2	V
Power Peak Dissipation	$P_D$	72	88	75	100	mW
Maximum Reverse Voltage	$V_{RM}$	5	7	4	4	V
Wavelength at Peak Emission	$\lambda$	620 ~ 630	528 ~ 538	583 ~ 595	464 ~ 476	nm
Current Reduction Rate Above 25°C	$\Delta I_F$	0.40	0.36	0.40	0.33	mA/°C
Ambient Temperature Range		-25 ~ +50		-25 ~ +50		°C

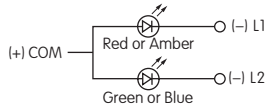

LEDs are an integral part of the switch and are not available separately.

LED circuit is isolated and requires an external power source.

If the source voltage exceeds the rated voltage, a ballast resistor is required.

The resistor value can be calculated by using the formula in the Supplement section.

Amber can be achieved by simultaneous illumination of Red & Green.  
Purple can be achieved by simultaneous illumination of Amber & Blue.

## PLUNGERS

### A 9.2mm Plunger for 12.0mm Cap

9.2mm Plunger is designed with a narrower neck to hold the 12.0mm Cap.

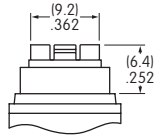

### B 11.6mm Plunger for 15.0mm & 17.4mm Caps

11.6mm Plunger is designed with a wider neck to hold both the 15.0mm and 17.4mm Caps.

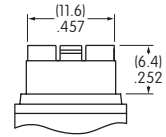

## CAP TYPES & COLORS

### Caps for Bicolor and RGB

### 1 12.0mm Square Used on A Plunger

#### F AT3083 Flat Cap

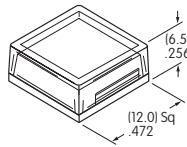

#### S AT3078 Sculptured Cap

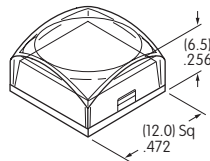

#### T AT3086 Home Key Cap

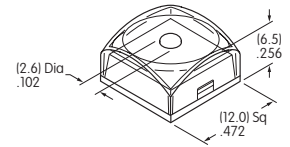

### 2 15.0mm Square Used on B Plunger

#### F AT3084 Flat Cap

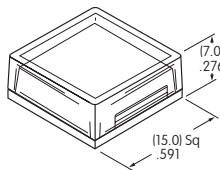

#### S AT3079 Sculptured Cap

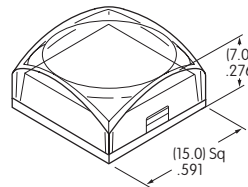

#### T AT3087 Home Key Cap

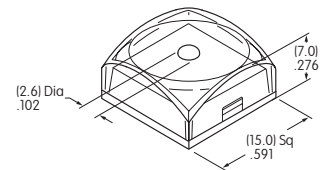

### 3 17.4mm Square Used on B Plunger

#### F AT3085 Flat Cap

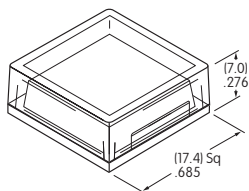

#### S AT3080 Sculptured Cap

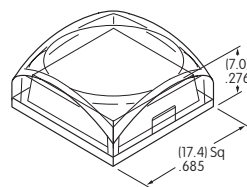

#### T AT3088 Home Key Cap

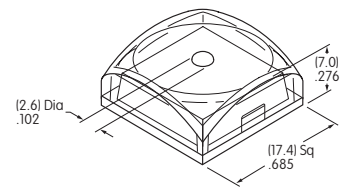

Toggles

Rockers

Pushbuttons

Programmable Illuminated PB

Keylocks

Rotaries

Slides

Tactiles

Tilt

Touch

Indicators

Accessories

Supplement

### Caps for Alternating Legends

**1** 12.0mm Square Used on A Plunger

**F** AT3093 Flat Cap

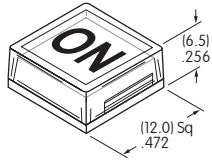

**S** AT3090 Sculptured Cap

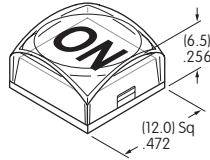

**T** AT3096 Home Key Cap

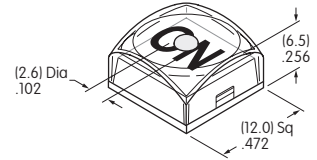

**2** 15.0mm Square Used on B Plunger

**F** AT3094 Flat Cap

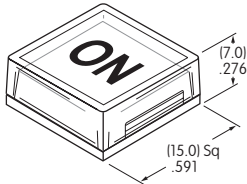

**S** AT3091 Sculptured Cap

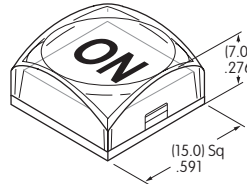

**T** AT3097 Home Key Cap

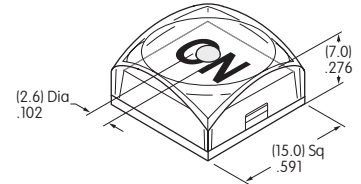

**3** 17.4mm Square Used on B Plunger

**F** AT3095 Flat Cap

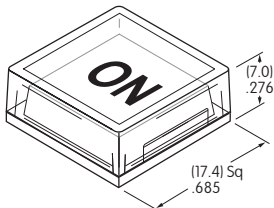

**S** AT3092 Sculptured Cap

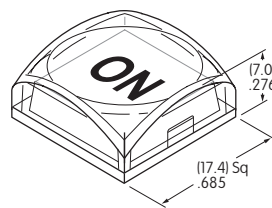

**T** AT3098 Home Key Cap

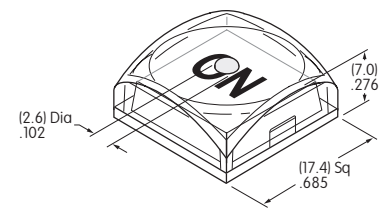

**JB** Lens & Diffuser Colors Available:

Clear/White

Materials & Finishes: Lens - Polycarbonate with glossy finish

Diffuser - Polycarbonate with textured finish

Optional Protective Guard AT4170 available; contact factory.

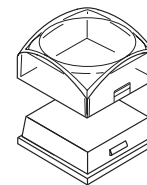

Clear Lens

White Diffuser

### Standard Alternating Legend Pairs



Green/Red or Blue/Amber



Green/Red or Blue/Amber



Green/Red or Blue/Amber



Green/Red or Blue/Amber

Cap illumination is alternating Green/Red or Blue/Amber; legend text is black.

Contact factory for other Alternating Legends.

Legend illustrations are approximate representations of the actual characters on the filters.

## TYPICAL SWITCH DIMENSIONS

### 12.0mm Square Cap

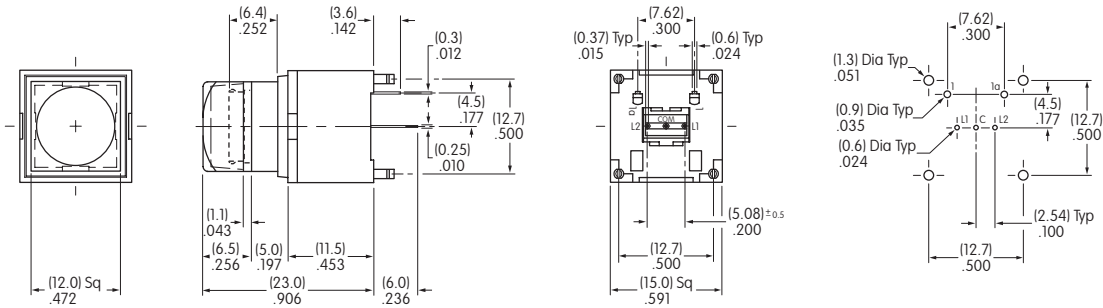

**KP0115ACAKG036CF-1SJB**

### 15.0mm Square Cap

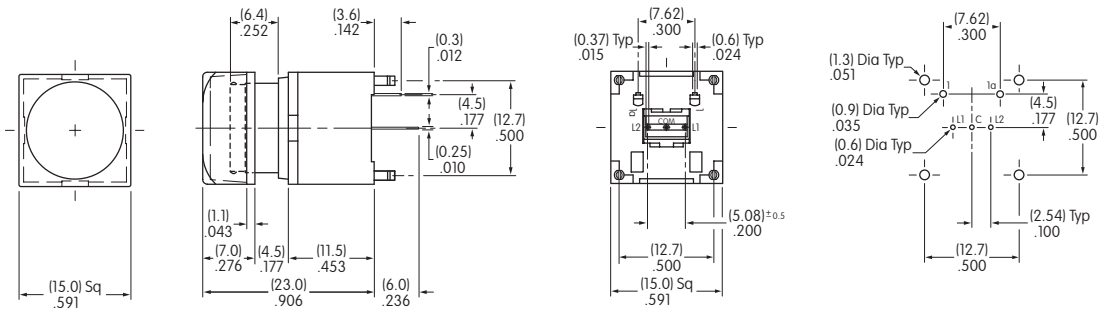

**KP0115ANBKG036CF-2SJB**

### 17.4mm Square Cap

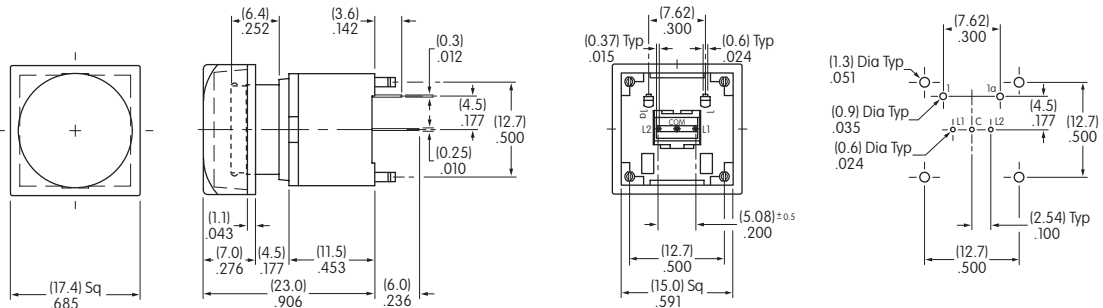

**KP0115ANBKG036CF-3SJB**

### Bicolor Alternating Legend • 15.0mm Square Cap

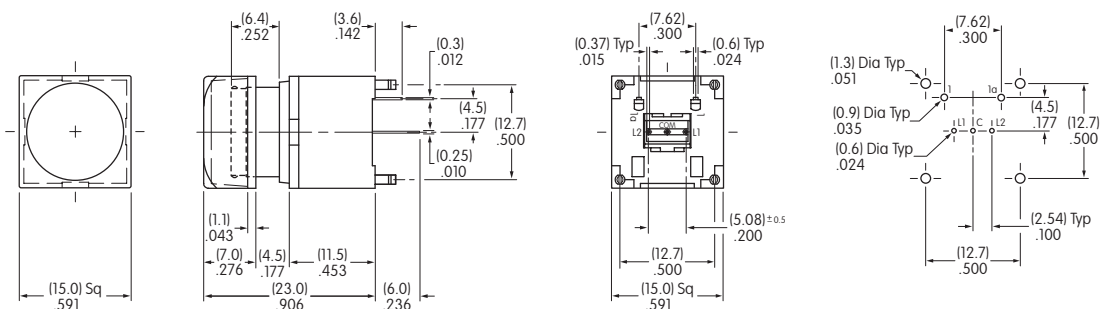

**KP0115ANBKG036DG-2SJDG**

Toggles

Rockers

Pushbuttons

Illuminated PB

Programmable

Keylocks

Rotaries

Slides

Tactiles

Tilt

Touch

Indicators

Accessories

Supplement

## RGB

### LED SPECIFICATIONS

The electrical specifications shown are determined at a basic temperature of 25°C.

LEDs are an integral part of the switch and are not available separately.

LED circuit is isolated and requires an external power source.

If the source voltage exceeds the rated voltage, a ballast resistor is required.

The resistor value can be calculated by using the formula in the Supplement Section.

Note: For applications that require white illumination, contact factory.

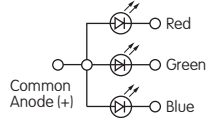

	Color	Red	Green	Blue	Unit
Maximum Forward Current	$I_{FM}$	30	30	30	mA
Typical Forward Current	$I_F$	20	14	9	mA
Forward Voltage	$V_F$	2.0	2.9	2.9	V
Power Peak Dissipation	$P_D$	60	80	80	mW
Maximum Reverse Voltage	$V_{RM}$	5	5	5	V
Dominant Wavelength	$\lambda_d$	621.5	522.5	472.5	nm
Current Reduction Rate Above 25°C	$\Delta I_F$	0.50	0.50	0.50	mA/°C
Ambient Temperature Range		-25 ~ +50			°C

### TYPICAL SWITCH DIMENSIONS

#### 12.0mm Square Cap with RGB LED

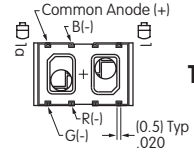
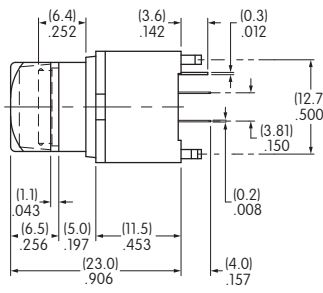
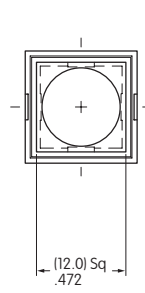

Terminal Detail

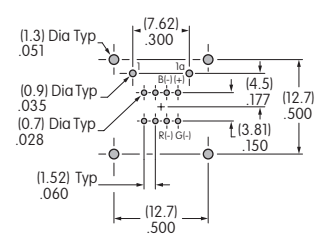
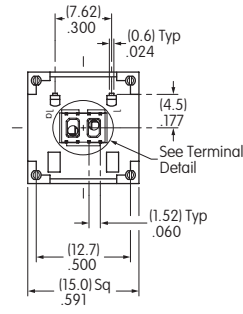

KP0115ACAKG03RGB-1SJB

#### 15.0mm & 17.4mm Square Caps with RGB LED

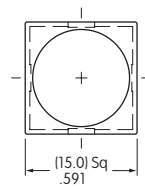

15.0mm Cap

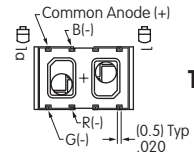

Terminal Detail

KP0115ANBKG03RGB-2SJB

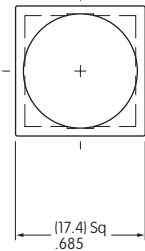

17.4mm Cap

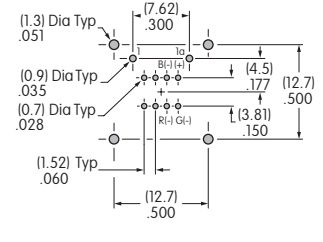
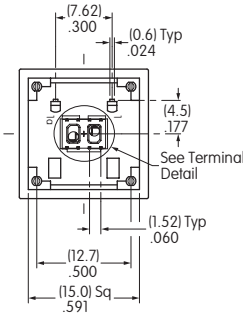

KP0115ANBKG03RGB-3SJB

## RECTANGULAR CAP ASSEMBLY

### CAP ASSEMBLY DIMENSIONS

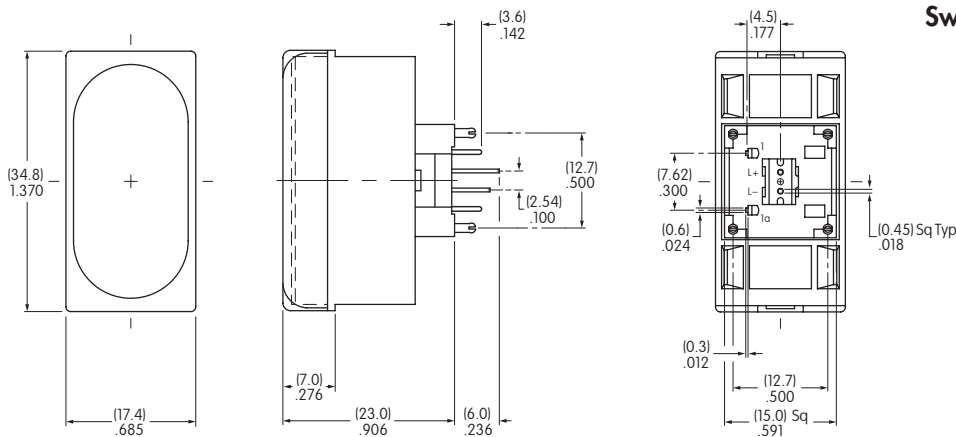

Switch/Rectangular Cap Assembly



**KP0115ACBK03CJB for Tactile**  
**KP0115ANBK03CJB for Nontactile**

See below for complete assembly of switch, LEDs and LED holders.

### LED SPECIFICATIONS

The electrical specifications shown are determined at a basic temperature of 25°C. Center LED is an integral part of the switch. LEDs are not sold separately. LED circuits are isolated and require an external power source. If the source voltage exceeds the rated voltage, a ballast resistor is required. The resistor value can be calculated by using the formula in the Supplement Section.

	Color	Red	Unit
Maximum Forward Current	$I_{FM}$	30	mA
Typical Forward Current	$I_F$	20	mA
Forward Voltage	$V_F$	2.0	V
Maximum Reverse Voltage	$V_{RM}$	4	V
Dominant Wavelength	$\lambda_d$	623	nm
Current Reduction Rate Above 25°C	$\Delta I_F$	0.32	mA/°C
Ambient Temperature Range		-25 ~ +50	°C

Contact factory for other LED colors.

### ASSEMBLY & INSTALLATION INSTRUCTIONS



Switch/Rectangular Cap assembly has 3 LEDs to achieve bright and even illumination.

One LED (in center of switch bottom) is an integral part of the switch; the other 2 LEDs and 2 LED Holders are packaged separately.

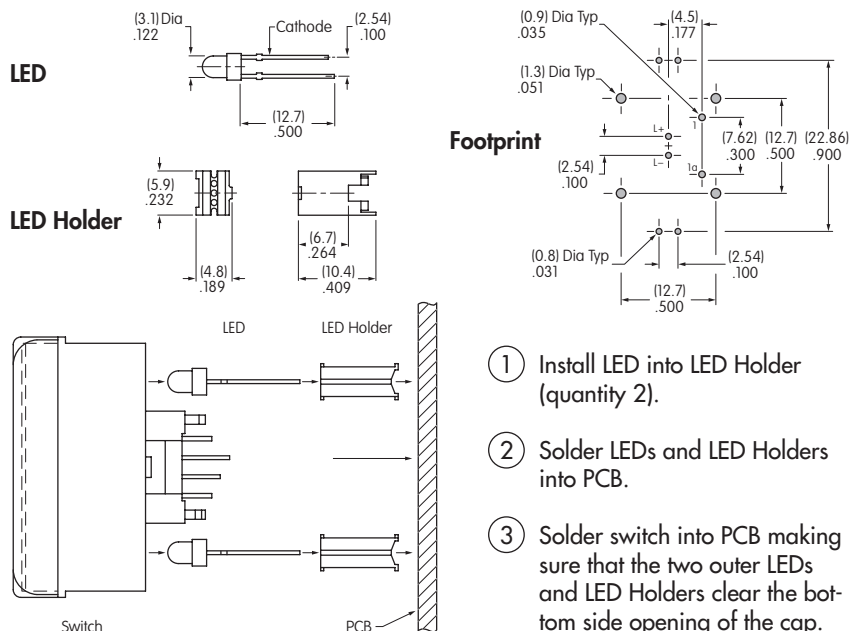

### ASSEMBLY INSTRUCTIONS FOR SQUARE CAPS



#### Cap Orientation

As shown in the accompanying illustration, the cap and plunger are designed with tabs and notches to assure proper orientation of the cap on the switch.

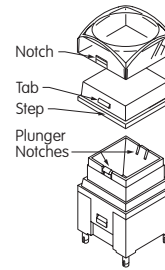

#### Removal of Cap Assembly & Separation of Lens & Diffuser

Holding the switch tightly, pull the cap off the switch. Once the cap assembly is released from the plunger, the lens and diffuser can be separated.

Pry up the lens with fingernail or flat tip screwdriver inserted at the step on the diffuser.

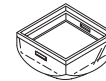

#### Installation or Replacement of Cap

After aligning notches with tabs, join the lens and diffuser. Hold the switch tightly without touching the terminals. Firmly press the cap onto the plunger by applying pressure from one side to the other until both are snapped together.

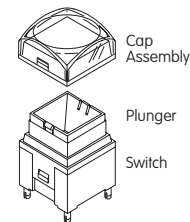



## LEGENDS

NKK Switches can provide custom legends for caps. Contact factory for more information.

### Suggested Printable Areas for KP Lens

#### Recommended Methods:

Laser Etch on clear lens, Screen Print, or Pad Print on lens.  
Laser Print on film insert.  
Epoxy based ink is recommended.

Printing on Diffuser  
is not advisable.

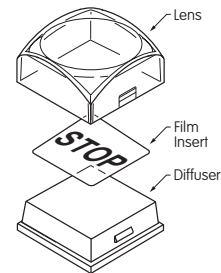

Shaded areas are suggested printable areas for Lens.

#### Rectangular Cap Lens

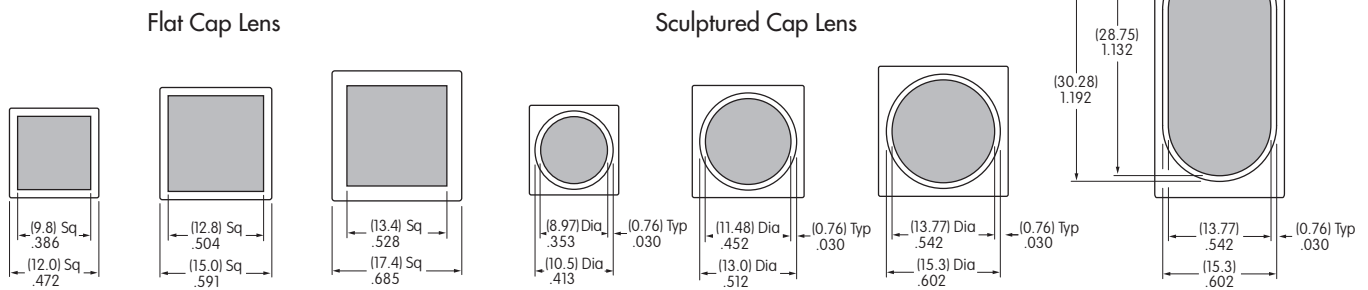

### Suggested Printable Areas for KP Film Insert

Shaded areas are suggested printable areas for Film Insert.

#### Rectangular Film Insert

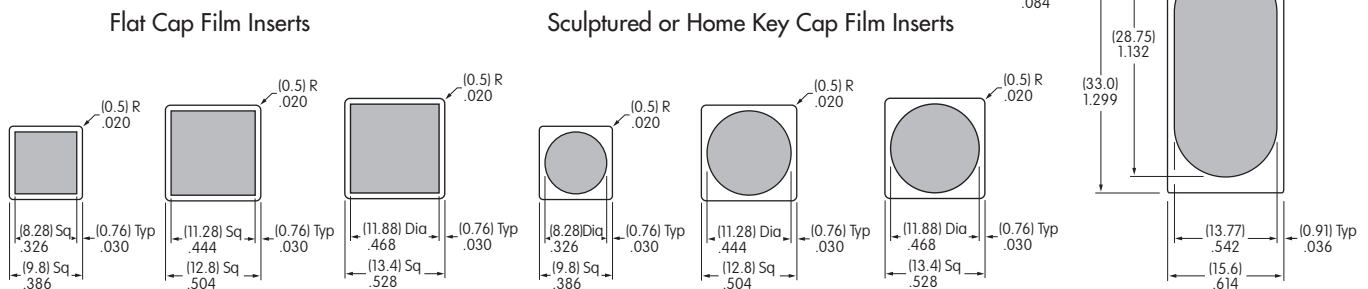

**Film Insert Material and Thickness:** Clear Polyester; 4 mil (100µ) maximum thickness

# General Specifications

## Electrical Capacity (Resistive Load)

**Power Level (silver):** 3A @ 125V AC or 3A @ 250V AC or 3A @ 30V DC

**Logic Level (gold):** 0.4VA maximum @ 28V AC/DC maximum  
(Applicable Range 0.1mA ~ 0.1A @ 20mV ~ 28V)

Note: Find additional explanation of operating range in Supplement section.

## Other Ratings

**Contact Resistance:** 50 milliohms maximum for silver; 100 milliohms maximum for gold

**Insulation Resistance:** 200 megohms minimum @ 500V DC

**Dielectric Strength:** 1,000V AC minimum between contacts for 1 minute minimum;  
1,500V AC minimum between contacts & case for 1 minute minimum

**Mechanical Life:** 1,000,000 operations minimum for momentary circuit  
200,000 operations minimum for maintained circuit

**Electrical Life:** 100,000 operations minimum

**Nominal Operating Force:** 4.41N

**Contact Timing:** Nonshorting (break-before-make)

**Travel:** Pretravel .059" (1.5mm); Overtravel .059" (1.5mm); Total Travel .118" (3.0mm)

## Materials & Finishes

**Housing:** Glass fiber reinforced polyamide (UL94V-0)

**Snap-in Frame:** Stainless steel

**Movable Contact:** Silver alloy or copper with gold plating

**Stationary Contacts:** Silver alloy or copper with gold plating

**Base:** Liquid crystal polymer (UL94V-0)

**Switch Terminals:** Phosphor bronze with silver or gold plating

**Lamp Terminals:** Brass with silver plating

## Environmental Data

**Operating Temperature Range:** -25°C through +50°C (-13°F through +122°F) for Illuminated  
-25°C through +70°C (-13°F through +158°F) for Nonilluminated  
Note: When used with a polyvinyl chloride splash cover, the lowest limit is 0°C (32°F)

**Humidity:** 90 ~ 95% humidity for 96 hours @ 40°C (104°F)

**Vibration:** 10 ~ 55Hz with peak-to-peak amplitude of 1.5mm traversing the frequency range & returning in 1 minute; 3 right angled directions for 2 hours

**Shock:** 50G (490m/s<sup>2</sup>) acceleration (tested in 6 right angled directions, with 5 shocks in each direction)

**Sealing:** Not available for snap-in; see next section for panel seal.

## Installation

**Cap Installation Force:** 3.92N maximum downward force on cap

**Quick Connect Force:** 52.95N maximum downward force on connector

**Soldering Time & Temperature:** Manual Soldering: See Profile A in Supplement section.

## Standards & Certifications

**Flammability Standards:** UL94V-0 housing & base

**UL:** **File No. E44145 - Recognized only when ordered with marking on switch.**

Add "/U" or "/CUL" before first dash in part number to order UL recognized switch.

All models recognized at 3A @ 125V or 250V AC or 0.4VA @ 28V AC/DC maximum.

**CSA:** **File No. 023535\_0\_000 - Certified only when ordered with marking on switch.**

Add "/C" before first dash in part number to order CSA certified switch.

All models certified at 3A @ 125V or 250V AC or 0.4VA @ 28V AC/DC maximum.

# Distinctive Characteristics

Carefully designed light diffusion and filtering system produces bright, full surface illumination with front panel relamping.

Spot illumination available in single and bicolor LEDs.

Choice of super bright LEDs in white, green, and blue in addition to standard or bright red, amber, and green LEDs.

Stainless steel clips provide secure mounting with a wide range of panel thicknesses.

Latchdown feature gives indication of circuit status. Audible and tactile feedback with smooth and responsive operation.

Snap-action contact mechanism gives long electrical life and sensitivity of actuation.

Combination solder lug and .110" quick connect terminals are epoxy sealed to prevent entry of flux, dust, and other contaminants.

Panel sealed model meets IP65 of IEC60529 specifications (similar to NEMA 4 & 13).

Compact switch design minimizes behind panel depth.

Matching indicators available.

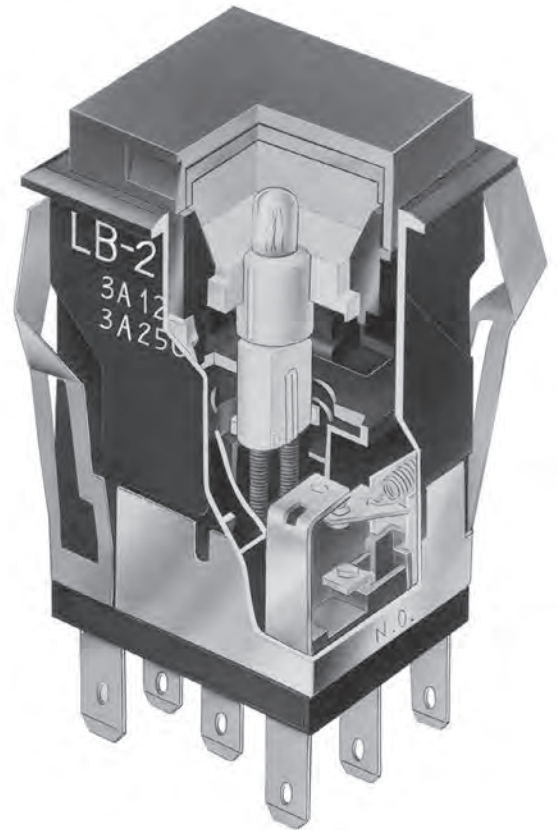

Actual Size

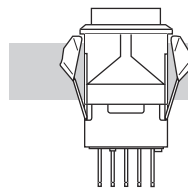
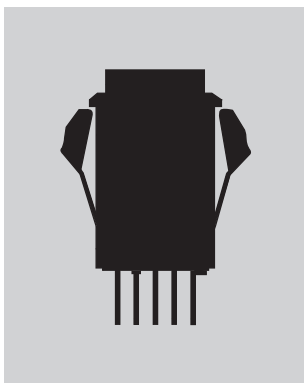

Snap-in Mount Page D48

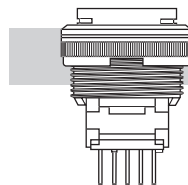

Panel Seal Page D59

- Toggle
- Rockers
- Pushbuttons
- D Illuminated PB**
- Programmable
- Key locks
- Rotaries
- Slides
- Tactiles
- Tilt
- Touch
- Indicators
- Accessories
- Supplement

### TYPICAL SWITCH

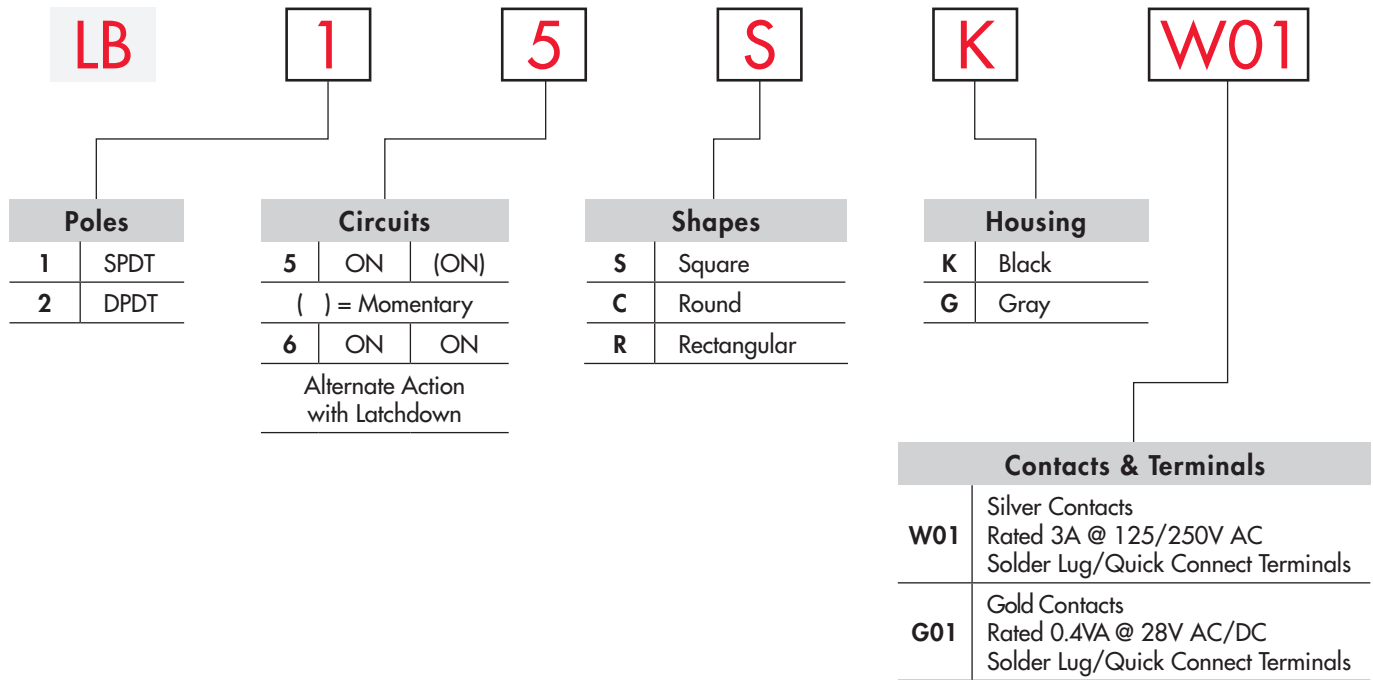

#### IMPORTANT:



Switches are supplied without UL, cULus and CSA marking unless specified.  
**UL, cULus & CSA recognized only when ordered with marking on the switch.**  
 Specific models, ratings, and ordering instructions are noted on the General Specifications page.

#### DESCRIPTION FOR TYPICAL ORDERING EXAMPLE

**LB15SKW01-5C12-JC**

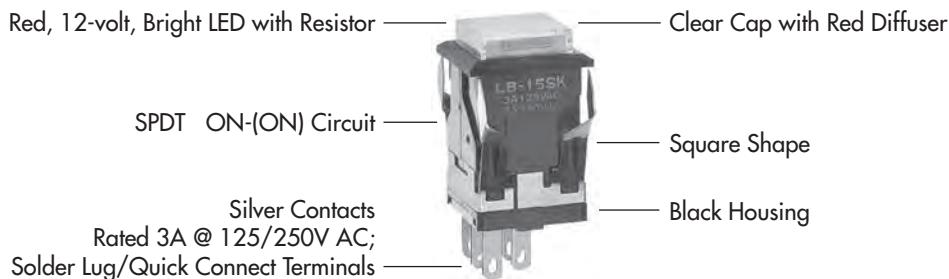

Toggles  
 Rockers  
 Pushbuttons  
 Illuminated PB  
 Programmable  
 Keylocks  
 Rotaries  
 Slides  
 Tactiles  
 Tilt  
 Touch  
 Indicators  
 Accessories  
 Supplement

## ORDERING EXAMPLE

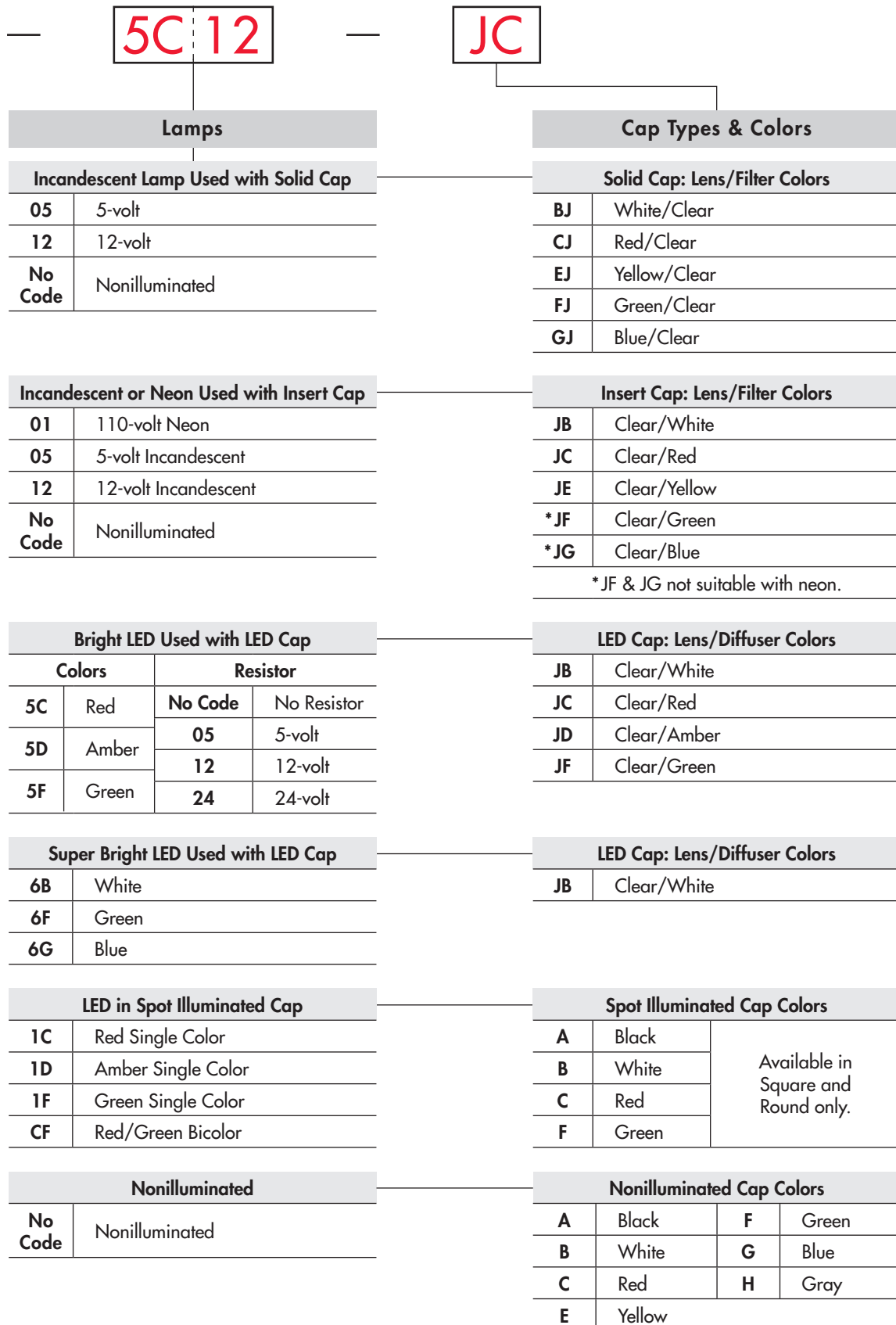

Toggles

Rockers

Pushbuttons

Illuminated PB

Programmable

Keylocks

Rotaries

Slides

Tactiles

Tilt

Touch

Indicators

Accessories

Supplement

## POLES & CIRCUITS

		Plunger Position ( ) = Momentary		Connected Terminals		Throw & Switch/Lamp Schematics
Pole	Model	Normal	Down	Normal	Down	Notes: Switch is marked with NC, NO, COM, L+, L-. Lamp circuit is isolated and requires an external power source.
SP	LB15 *LB16	ON ON	(ON) ON	1-3	1-2	SPDT 
DP	LB25 *LB26	ON ON	(ON) ON	1-3 4-6	1-2 4-5	DPDT 

\* When in latchdown position for the alternate circuit, cap position is .039" (1.0mm) above the built-in bezel.

## SHAPES & PANEL CUTOUTS

**S** .622" (15.8mm)  
Square

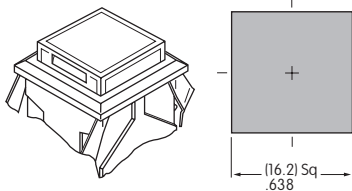

Cutout for 1 switch:  
.638" x .638" (16.2mm x 16.2mm)  
Cutout for 1 switch with barriers:  
.638" x .815" (16.2mm x 20.7mm)

**C** .854" (21.7mm)  
Round

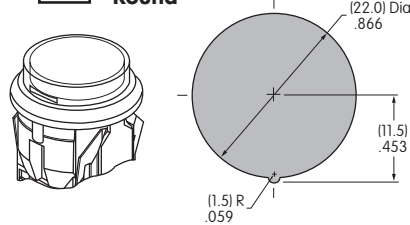

**R** .622" x .866" (15.8mm x 22.0mm)  
Rectangular

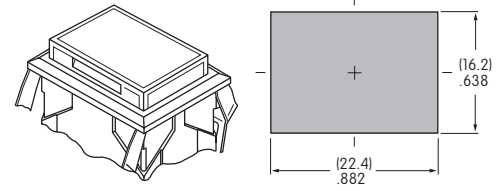

Cutout for 1 switch:  
.638" x .882" (16.2mm x 22.4mm)  
Cutout for 1 switch with barriers:  
.638" x 1.059" (16.2mm x 26.9mm)

Panel Thickness for Switches & Barriers: .039" ~ .157" (1.0 ~ 4.0mm)  
Panel Thickness for Protective Guards & Splash Covers: .039" ~ .138" (1.0 ~ 3.5mm)

## HOUSING

Housing Colors Available:

**K** Black

**G** Gray

## CONTACT MATERIALS, RATINGS & TERMINALS

**W01**

Silver Contacts

Power Level  
3A @ 125V AC & 250V AC

Solder Lug/Quick Connect

Optional PCB adaptors  
AT711 & AT712 available;  
illustrated in "Optional  
Accessories" immediately following  
"Typical Switch Dimensions."

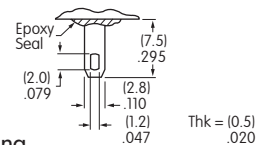

**G01**

Gold Contacts

Logic Level  
0.4VA max. @ 28V AC/DC max.

Complete explanation of operating range in Supplement section.

## INCANDESCENT & NEON LAMP CODES & SPECIFICATIONS

AT607 & AT607N



T-1 Bi-pin

AT607 Incandescent 5-volt or 12-volt; AT607N Neon 110-volt	<b>05</b>	<b>12</b>	<b>01</b> *
Voltage	5V AC	12V AC	110V AC
Current	115mA	60mA	1.5mA
Endurance Avg. Hours	10,000		10,000
Ambient Temp. Range	-25°C ~ +50°C		

The electrical specifications shown are determined at a basic temperature of 25°C. Lamp circuit is isolated and requires external power source.

\* Recommended Resistors for Neon:  
33K ohms for 110V AC;  
100K ohms for 220V AC

## LED COLORS & SPECIFICATIONS

The electrical specifications shown are determined at a basic temperature of 25°C. LED circuit is isolated and requires external power source. Polarity marks are on the switch.

If the source voltage exceeds the rated voltage, a ballast resistor is required. The resistor value can be calculated by using the formula in the Supplement section. Additional lamp detail is shown in the Accessories & Hardware section.

### Bright LED without Resistor

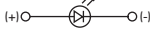
<b>AT635</b> LEDs are colored in OFF state.   T-1 1/2 Bi-pin	Color Codes			No Resistor		
	Red	Amber	Green	<b>No Code</b>		
	<b>5C</b>	<b>5D</b>	<b>5F</b>	Red	Amber	Green
	Maximum Forward Current	$I_{FM}$		30mA	30mA	30mA
	Typical Forward Current	$I_F$		20mA	20mA	20mA
	Forward Voltage	$V_F$		1.9V	2.0V	2.1V
	Maximum Reverse Voltage	$V_{RM}$		5V	5V	5V
Current Reduction Rate Above 25°C	$\Delta I_F$		0.42mA/°C			
Ambient Temperature Range			-25° ~ +50°C			

### Bright LED with Resistor

<b>AT627 with Resistor</b>  T-1 Bi-pin	Color Codes:			Resistor Codes		
	Red	Amber	Green	<b>05</b>	<b>12</b>	<b>24</b>
	<b>5C</b>	<b>5D</b>	<b>5F</b>			
	Maximum Forward Current	$I_{FM}$		—	—	—
	Typical Forward Current	$I_F$		52mA	26mA	13mA
	Forward Voltage	$V_F$		5V	12V	24V
	Maximum Reverse Voltage	$V_{RM}$		4V	8V	16V
Current Reduction Rate Above 25°C	$\Delta I_F$		0.50mA/°C			
Ambient Temperature Range			-25° ~ +50°C			

AT627  
5-volt  
4-element  
with Resistor

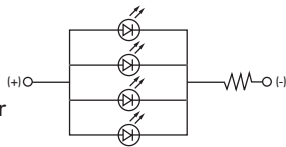

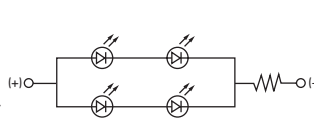

AT627  
12-volt  
4-element  
with Resistor

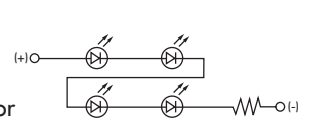

AT627  
24-volt  
4-element  
with Resistor



### Super Bright Single Element LED

<b>AT625G Blue</b> <b>AT631B White</b> <b>AT632F Green</b>   T-1 Bi-pin				<b>6B</b>	<b>6F</b>	<b>6G</b>
		Color	White	Green	Blue	
	Maximum Forward Current	$I_{FM}$	30mA	30mA	30mA	
	Typical Forward Current	$I_F$	20mA	20mA	20mA	
	Forward Voltage	$V_F$	3.3V	3.3V	3.3V	
	Maximum Reverse Voltage	$V_{RM}$	7V	7V	7V	
	Current Reduction Rate Above 25°C	$\Delta I_F$	0.40mA/°C	0.40mA/°C	0.40mA/°C	
Ambient Temperature Range		-25° ~ +50°C				

**No Code** No Lamp

## CAP TYPES & COLOR COMBINATIONS

Color Codes: **B** White **C** Red **D** Amber **E** Yellow **F** Green **G** Blue **J** Clear

### Solid Cap for Incandescent Lamp & Nonilluminated

Lens/Filter  
Colors Available:

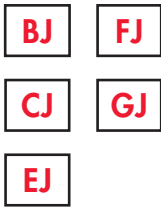

**AT476**  
Square

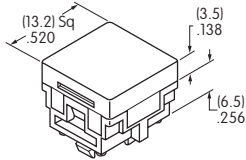

**AT4012**  
Round

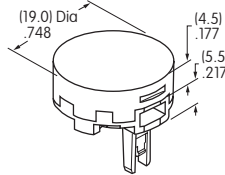

**AT4026**  
Rectangular

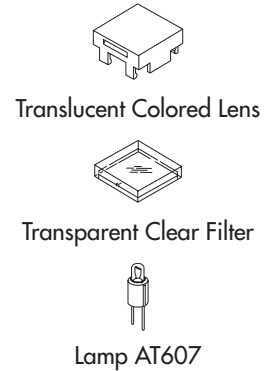
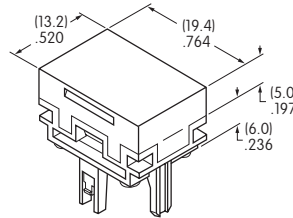

Material: Polycarbonate Finish: Glossy

### Insert Cap for Incandescent or Neon Lamp & Nonilluminated

Lens/Filter  
Colors Available:

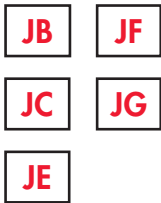

**AT477**  
Square

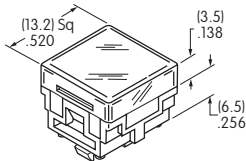

**AT4013**  
Round

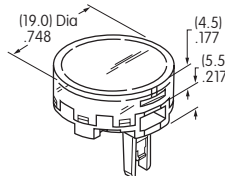

**AT4027**  
Rectangular

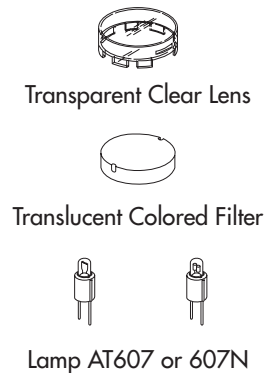
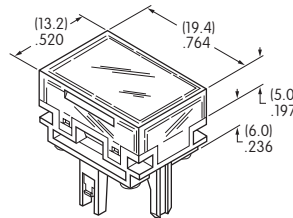

JF and JG not suitable with neon lamp.

Material: Polycarbonate Finish: Glossy

### Cap for Bright LED without Resistor

Lens/Diffuser  
Colors Available:



**AT4176**  
Square

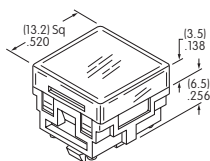

**AT4178**  
Round

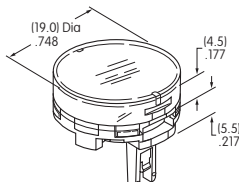

**AT4177**  
Rectangular

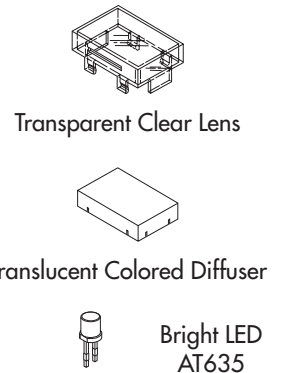
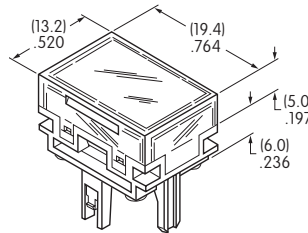

Material: Polycarbonate Finish: Glossy

### Cap for Bright LED with Resistor

Lens/Diffuser  
Colors Available:



**AT4162**  
Square

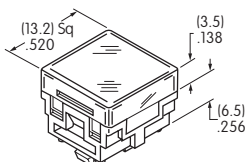

**AT4164**  
Round

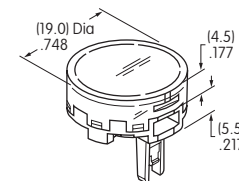

**AT4163**  
Rectangular

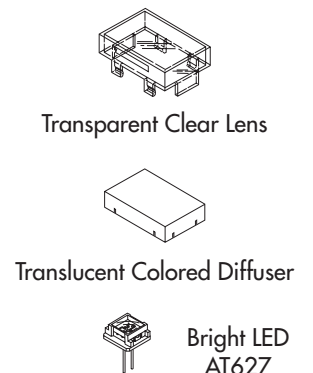
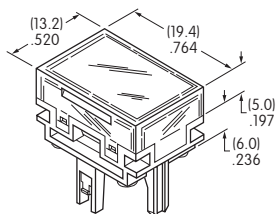

Material: Polycarbonate Finish: Glossy

Toggles  
Rockers  
Pushbuttons  
Illuminated PB  
Programmable  
Keylocks  
Rotaries  
Slides  
Tactiles  
Tilt  
Touch  
Indicators  
Accessories  
Supplement



## CAP TYPES & COLOR COMBINATIONS

Color Codes: **A** Black **B** White **C** Red **D** Amber **E** Yellow **F** Green **G** Blue **H** Gray **J** Clear

### Cap for Super Bright LEDs

**JB**

Clear Lens  
White Diffuser

**AT4129**  
Square

**AT4128**  
Round

**AT4130**  
Rectangular

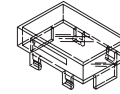

Transparent  
Clear Lens

Material:  
Polycarbonate  
Finish: Glossy

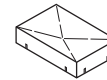
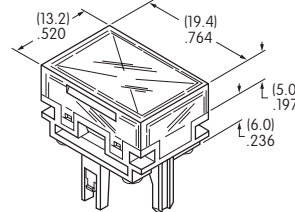
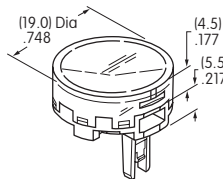
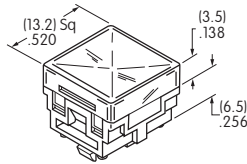

Translucent  
White Diffuser



LEDs AT625  
AT631 AT632

### Spot Illuminated Cap with LED

The electrical specifications shown are determined at a basic temperature of 25°C. LED circuit is isolated and requires an external power source. Single color LEDs are colored in OFF state; bicolor LEDs are translucent white in OFF state. Polarity marks are on the switch. If the source voltage exceeds the rated voltage, a ballast resistor is required. The resistor value can be calculated by using the formula in the Supplement section. Additional lamp detail is shown in the Accessories & Hardware section.

### LED Specifications

LED factory assembled in Spot Illuminated Caps	Single Color LED with 1 Element 	Bicolor LED with 2 Elements 	Single Color			Bicolor
			<b>1C</b> Red	<b>1D</b> Amber	<b>1F</b> Green	<b>CF</b> Red/Green
Maximum Forward Current		$I_{FM}$	25mA	30mA	25mA	30/25mA
Typical Forward Current		$I_F$	20mA	20mA	20mA	20mA
Forward Voltage		$V_F$	2.25V	2.1V	2.2V	2.0/2.2V
Maximum Reverse Voltage		$V_{RM}$	5V	5V	5V	—
Current Reduction Rate Above 25°C		$\Delta I_F$	0.33mA/°C	0.40mA/°C	0.33mA/°C	0.43/0.38mA/°C
Ambient Temperature Range	-25° ~ +70°C					

Cap Colors Available:

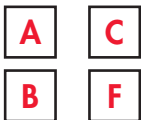

Material:  
Polycarbonate  
Finish: Glossy

**AT480**  
Square

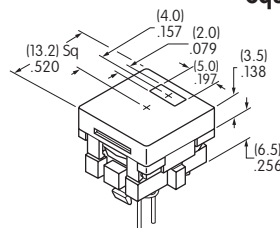

**AT4016**  
Round

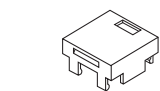
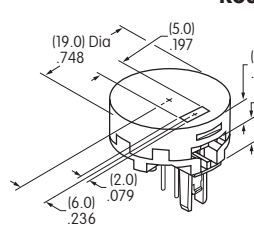

Cap with Window



Factory Assembled LED;  
Not Available Separately

When ordering spot illuminated cap separately, LED color must be specified.

Examples: AT480CA (red LED, black cap); AT4016CFB (red/green bicolored LED, white cap)

### Cap for Nonilluminated

Cap Colors Available:

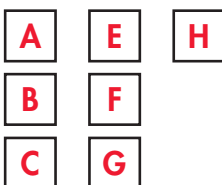

**AT484**  
Square

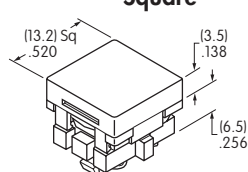

**AT4017**  
Round

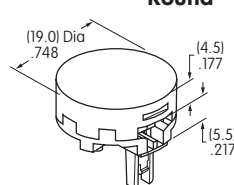

**AT4030**  
Rectangular

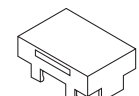
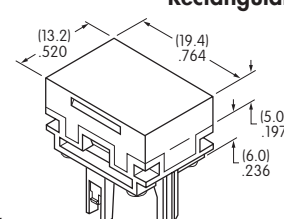

Cap

No Lamp

Material: Polycarbonate Finish: Glossy

## TYPICAL SWITCH DIMENSIONS

### Square

### Single & Double Pole

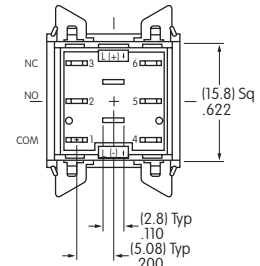
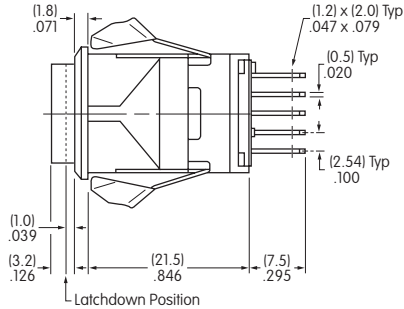
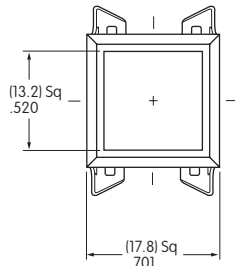

**LB15SKW01-12-CJ**

Single pole models do not have terminals 4, 5, & 6.

### Round

### Single & Double Pole

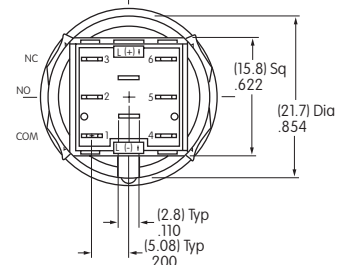
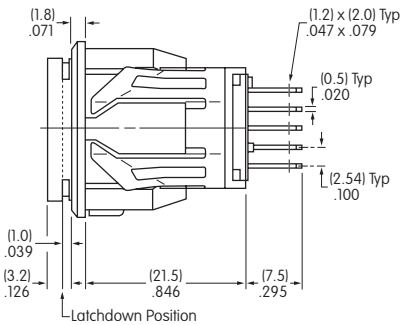
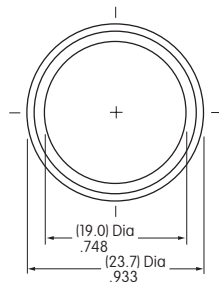

**LB16CKW01-12-CJ**

Single pole models do not have terminals 4, 5, & 6.

### Rectangular

### Single & Double Pole

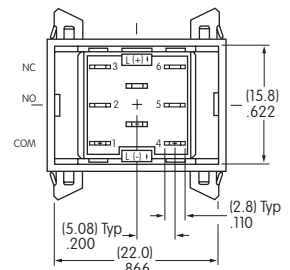
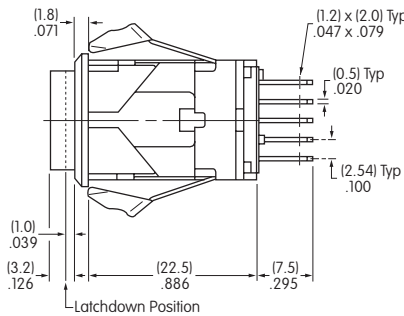
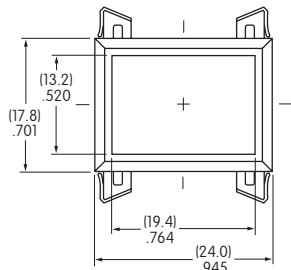

**LB26RGW01-12-CJ**

Single pole models do not have terminals 4, 5, & 6.

## OPTIONAL ACCESSORIES

### PCB Adaptors

#### AT711 Single Pole • Straight PC Terminals

#### AT712 Double Pole • Straight PC Terminals

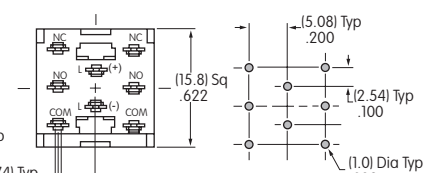
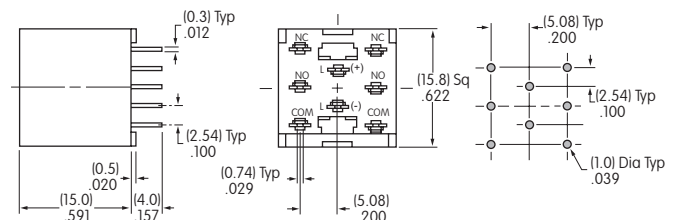
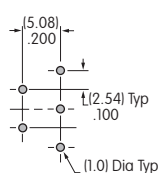
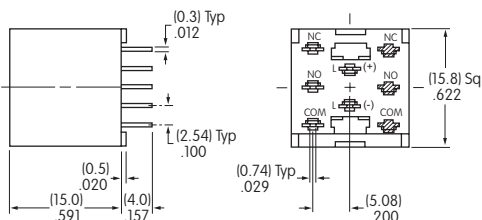

Note: Order adaptors separately.

## OPTIONAL ACCESSORIES

### Barriers

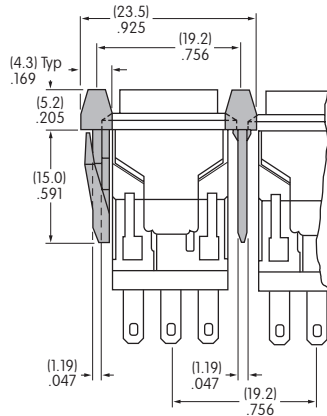
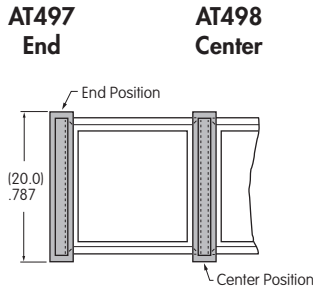

### Cutouts for More Than 1 Switch

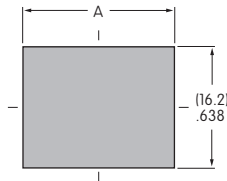

**Square**  
A = .752" (19.1mm) x Number of Switches + .051" (1.3mm)  
**Rectangular**  
A = .996" (25.3mm) x Number of Switches + .051" (1.3mm)

### Protective Guard

#### AT499 Square Protective Guard

Opens 90°  
Closes manually

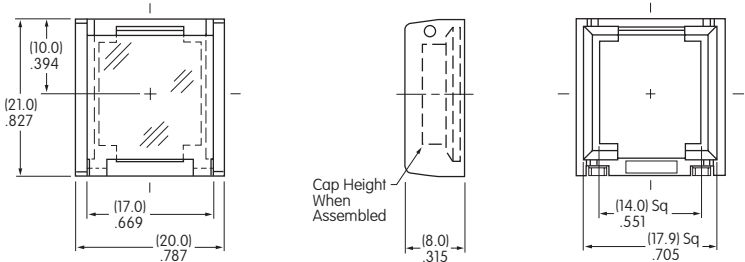

Material: Polyamide

Protective Guards reduce depth of switch behind panel by .020" (0.5mm).

### Spring Loaded Protective Guard

#### AT4171 Square Protective Guard

Opens 180°  
Closes automatically

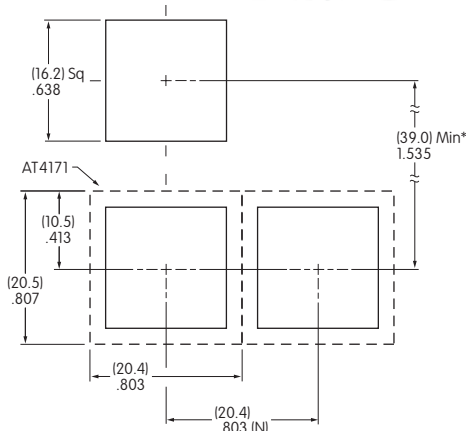
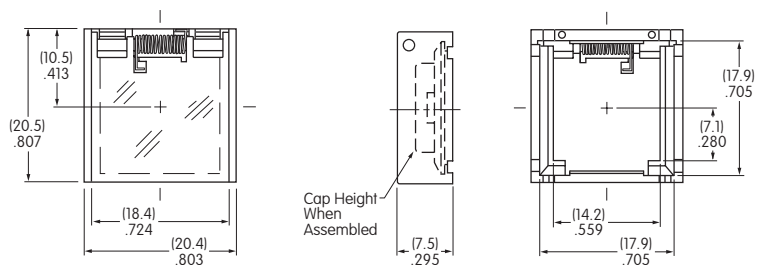
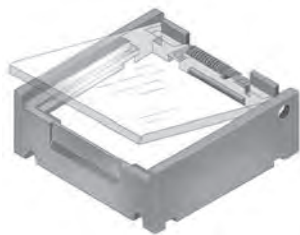

(N) = Number of switches \* Minimum dimension allows opening of cover to 180°

**Materials:**  
Cover: Clear Polycarbonate  
Base: Black GFR Polyamide  
Coil Spring: Stainless Steel

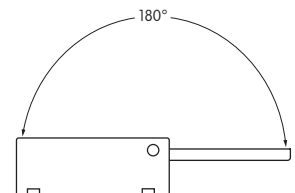

**Recommended Panel Thickness:**  
.039" ~ .106" (1.0mm ~ 2.7mm)

## OPTIONAL ACCESSORIES

### AT4057 Rectangular Protective Guard

Opens 90°  
Closes manually

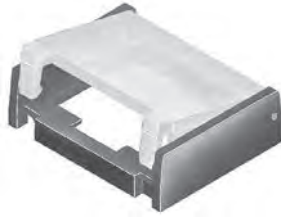

### Protective Guard

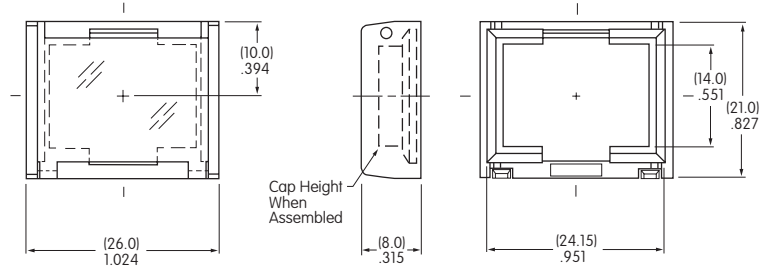

Material: Polyamide

Protective Guards reduce depth of switch behind panel by .020" (0.5mm).

### AT4172 Rectangular Protective Guard



### Spring Loaded Protective Guard

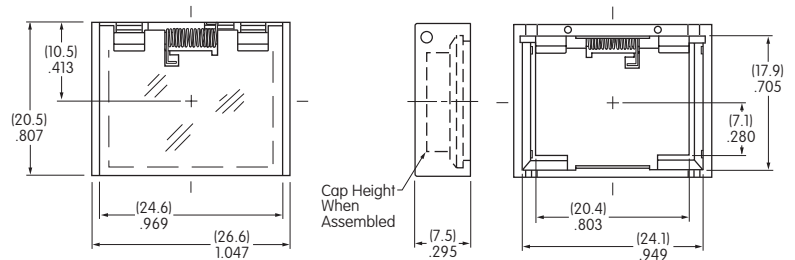

Opens 180°  
Closes automatically

**Materials:**  
Cover: Clear Polycarbonate  
Base: Black GFR Polyamide  
Coil Spring: Stainless Steel

Recommended Panel Thickness:  
.039" ~ .106" (1.0mm ~ 2.7mm)

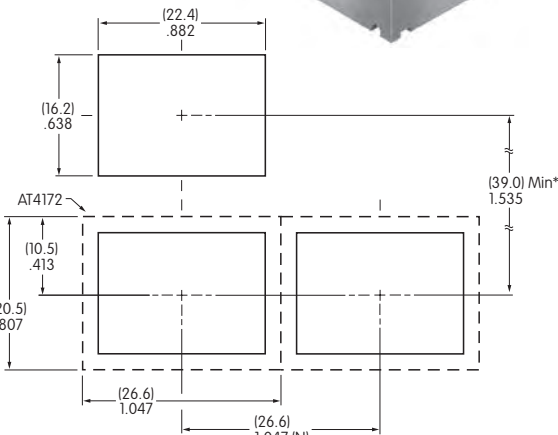
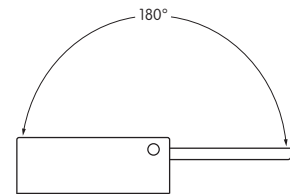

(N) = Number of switches \* Minimum dimension allows opening of cover to 180°

### Dust Covers

#### AT4002 Round



#### AT4001 Square

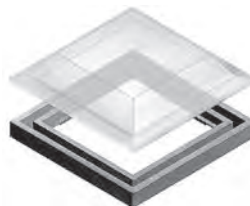

#### AT4011 Rectangular

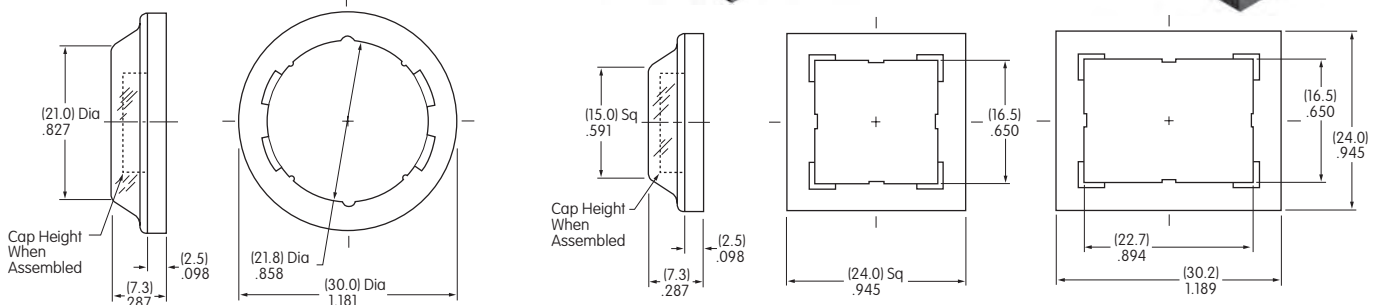
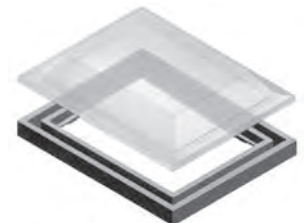

Materials: PVC with polyethylene gasket; PVC loses pliability below 0°C (32°F). Dust Covers reduce depth of switch behind panel by .020" (0.5mm).

# General Specifications

## Electrical Capacity (Resistive Load)

<b>Power Level (silver):</b>	3A @ 125V AC or 3A @ 250V AC or 3A @ 30V DC
<b>Logic Level (gold):</b>	0.4VA maximum @ 28V AC/DC maximum (Applicable Range 0.1mA ~ 0.1A @ 20mV ~ 28V)

Note: Find additional explanation of operating range in Supplement section.

## Other Ratings

<b>Contact Resistance:</b>	50 milliohms maximum for silver; 100 milliohms maximum for gold
<b>Insulation Resistance:</b>	200 megohms minimum @ 500V DC
<b>Dielectric Strength:</b>	1,000V AC minimum between contacts for 1 minute minimum; 1,500V AC minimum between contacts & case for 1 minute minimum
<b>Mechanical Life:</b>	1,000,000 operations minimum for momentary circuit 200,000 operations minimum for maintained circuit
<b>Electrical Life:</b>	100,000 operations minimum
<b>Nominal Operating Force:</b>	5.39N
<b>Contact Timing:</b>	Nonshorting (break-before-make)
<b>Travel:</b>	Pretravel .059" (1.5mm); Overtravel .059" (1.5mm); Total Travel .118" (3.0mm)

## Materials & Finishes

<b>Housing:</b>	Glass fiber reinforced polyamide (UL94V-0)
<b>O-ring:</b>	Nitrile butadiene rubber
<b>Inner Seal:</b>	Silicone rubber
<b>Movable Contact:</b>	Silver alloy or copper with gold plating
<b>Stationary Contacts:</b>	Silver alloy or copper with gold plating
<b>Base:</b>	Liquid crystal polymer (UL94V-0)
<b>Switch Terminals:</b>	Phosphor bronze with silver or gold plating
<b>Lamp Terminals:</b>	Brass with silver plating

## Environmental Data

<b>Operating Temperature Range:</b>	-25°C through +50°C (-13°F through +122°F) for Illuminated -25°C through +70°C (-13°F through +158°F) for Nonilluminated Note: When used with a polyvinyl chloride splash cover, the lowest limit is 0°C (32°F)
<b>Humidity:</b>	90 ~ 95% humidity for 96 hours @ 40°C (104°F)
<b>Vibration:</b>	10 ~ 55Hz with peak-to-peak amplitude of 1.5mm traversing the frequency range & returning in 1 minute; 3 right angled directions for 2 hours
<b>Shock:</b>	50G (490m/s <sup>2</sup> ) acceleration (tested in 6 right angled directions, with 5 shocks in each direction)
<b>Sealing:</b>	IP65 of IEC60529 standard (similar to NEMA 4 & 13)

## Installation

<b>Mounting Torque:</b>	1.96Nm (17.35 lb•in) maximum
<b>Cap Installation Force:</b>	3.92N maximum downward force on cap
<b>Quick Connect Force:</b>	52.95N maximum downward force on connector
<b>Soldering Time &amp; Temperature:</b>	Manual Soldering: See Profile A in Supplement section.

## Standards & Certifications

<b>Flammability Standards:</b>	UL94V-0 housing & base
<b>UL:</b>	<b>File No. E44145 - Recognized only when ordered with marking on switch.</b> Add "/U" or "/CUL" before first dash in part number to order UL recognized switch. All models recognized at 3A @ 125V or 250V AC or 0.4VA @ 28V AC/DC maximum.
<b>CSA:</b>	<b>File No. 023535_0_000 - Certified only when ordered with marking on switch.</b> Add "/C" before first dash in part number to order CSA certified switch. All models certified at 3A @ 125V or 250V AC or 0.4VA @ 28V AC/DC maximum.

# Series LB

## Standard Size Panel Seal Pushbuttons

### TYPICAL SWITCH

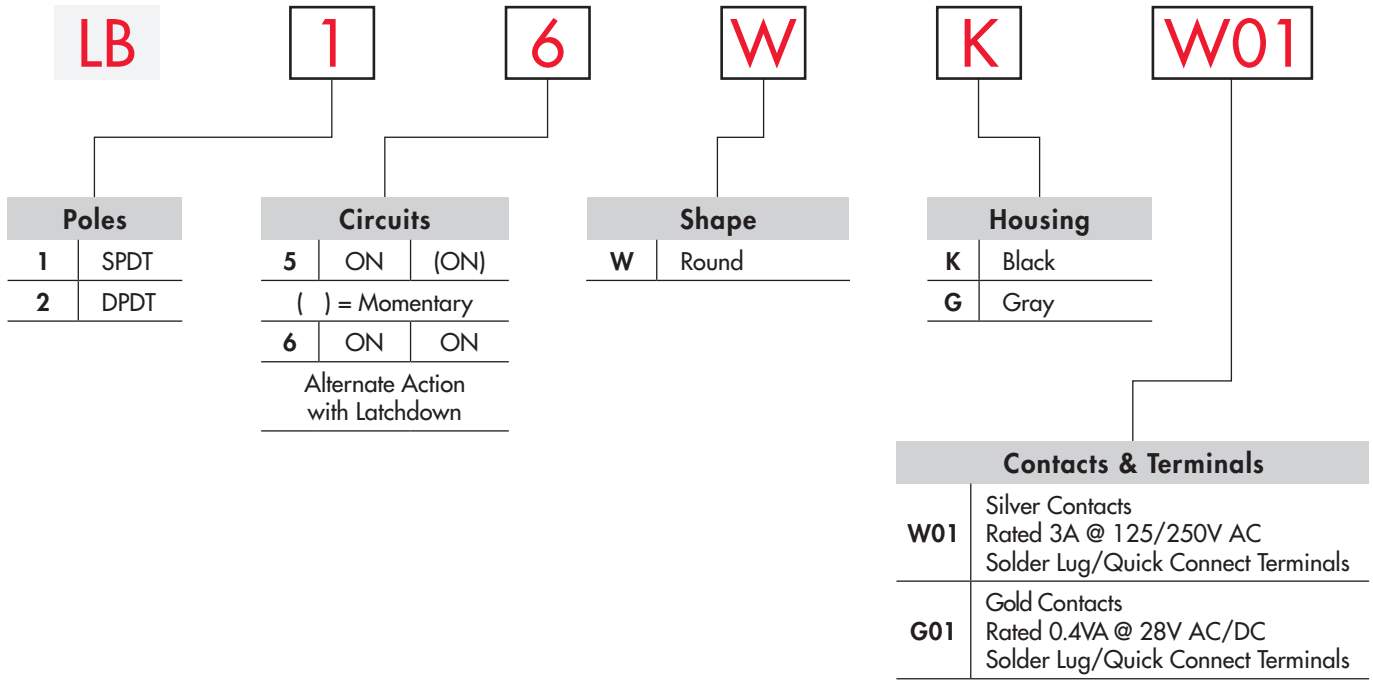

### IMPORTANT:



Switches are supplied without UL, cULus & CSA marking unless specified.  
**UL, cULus & CSA recognized only when ordered with marking on the switch.**  
 Specific models, ratings, & ordering instructions are noted on the General Specifications page.

### DESCRIPTION FOR TYPICAL ORDERING EXAMPLE

**LB16WKW01-5C12-JC**



## ORDERING EXAMPLE

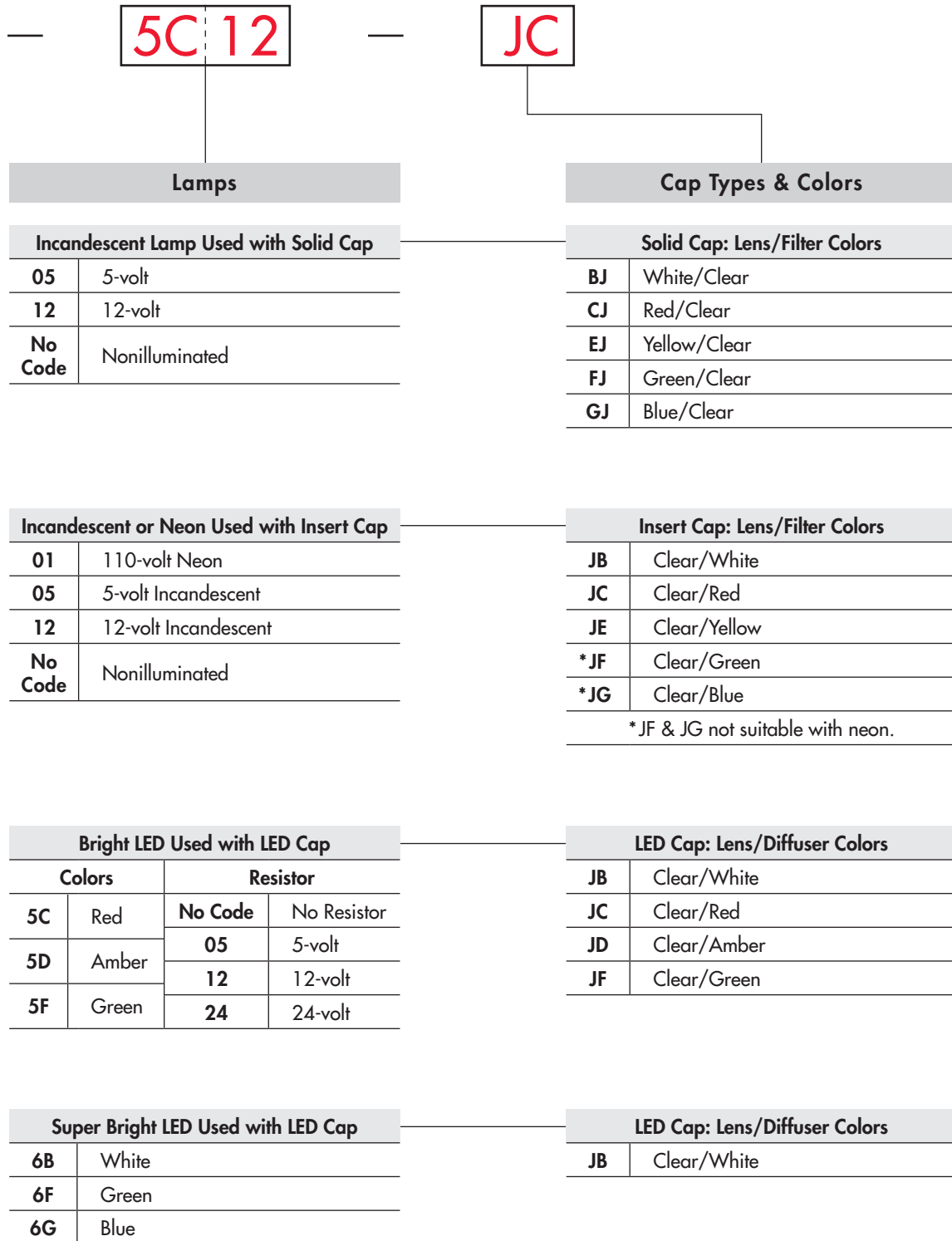

Toggle

Rockers

Pushbuttons

**D** Illuminated PB

Programmable

Key locks

Rotaries

Slides

Tactiles

Tilt

Touch

Indicators

Accessories

Supplement

Toggles

Rockers

Pushbuttons

Illuminated PB

Programmable

Keylocks

Rotaries

Slides

Tactiles

Tilt

Touch

Indicators

Accessories

Supplement

## POLES & CIRCUITS

Pole	Model	Plunger Position ( ) = Momentary		Connected Terminals		Throw & Switch/Lamp Schematics
		Normal	Down	Normal	Down	
SP	LB15 *LB16	ON ON	(ON) ON	1-3	1-2	SPDT 
DP	LB25 *LB26	ON ON	(ON) ON	1-3 4-6	1-2 4-5	DPDT 

\* When in latchdown position for the alternate circuit, cap position is .039" (1.0mm) above the built-in bezel.

## SHAPE & PANEL CUTOUT

**W** .866" (22.0mm)  
Round

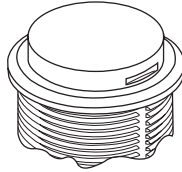

Recommended Panel Thickness:  
.039" ~ .157" (1.0mm ~ 4.0mm)

Recommended Panel Thickness with Splash Cover:  
.039" ~ .138" (1.0mm ~ 3.5mm)

Overtightening the mounting nut AT074  
may damage the switch housing.

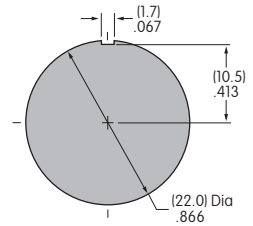

## HOUSING

Housing Colors Available:

**K** Black

**G** Gray

## CONTACT MATERIALS, RATINGS & TERMINALS

**W01** Silver Contacts      Power Level  
3A @ 125V AC & 250V AC

Solder Lug/Quick Connect

**G01** Gold Contacts      Logic Level  
0.4VA max. @ 28V AC/DC max.

Optional PCB adaptors AT711  
& AT712 available; illustrated  
in previous snap-in subsection.

Complete explanation of operating range in Supplement section.

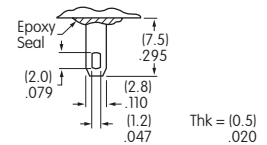

## INCANDESCENT & NEON LAMP CODES & SPECIFICATIONS

AT607 & AT607N		<b>05</b>	<b>12</b>	<b>01</b> *		
	AT607 Incandescent 5-volt or 12-volt; AT607N Neon 110-volt				The electrical specifications shown are determined at a basic temperature of 25°C. Lamp circuit is isolated and requires external power source.  * Recommended Resistors for Neon: 33K ohms for 110V AC; 100K ohms for 220V AC	
	Voltage	V	5V AC	12V AC		110V AC
	Current	I	115mA	60mA		1.5mA
	Endurance	Avg. Hours	10,000			10,000
	Ambient Temp. Range		-25°C ~ +50°C			



T-1 Bi-pin



## LED COLORS & SPECIFICATIONS



The electrical specifications shown are determined at a basic temperature of 25°C. LED circuit is isolated and requires external power source. Polarity marks are on the switch.

If the source voltage exceeds the rated voltage, a ballast resistor is required.

The resistor value can be calculated by using the formula in the Supplement section.

Additional lamp detail is shown in the Accessories & Hardware section.

### Bright LED without Resistor

<b>AT635</b>  LEDs are colored in OFF state.      T-1 1/2 Bi-pin	Color Codes	Red <b>5C</b>	Amber <b>5D</b>	Green <b>5F</b>	<b>No Code</b> No Resistor		
	Maximum Forward Current			$I_{FM}$	30mA	30mA	30mA
	Typical Forward Current			$I_F$	20mA	20mA	20mA
	Forward Voltage			$V_F$	1.9V	2.0V	2.1V
	Maximum Reverse Voltage			$V_{RM}$	5V	5V	5V
	Current Reduction Rate Above 25°C			$\Delta I_F$	0.42mA/°C		
	Ambient Temperature Range				-25° ~ +50°C		

### Bright LED with Resistor

<b>AT627 with Resistor</b>    T-1 Bi-pin	Color Codes:	Red <b>5C</b>	Amber <b>5D</b>	Green <b>5F</b>	Resistor Codes		
					<b>05</b>	<b>12</b>	<b>24</b>
	Maximum Forward Current			$I_{FM}$	—	—	—
	Typical Forward Current			$I_F$	52mA	26mA	13mA
	Forward Voltage			$V_F$	5V	12V	24V
	Maximum Reverse Voltage			$V_{RM}$	4V	8V	16V
	Current Reduction Rate Above 25°C			$\Delta I_F$	0.50mA/°C		
	Ambient Temperature Range				-25° ~ +50°C		

AT627  
5-volt  
4-element  
with Resistor

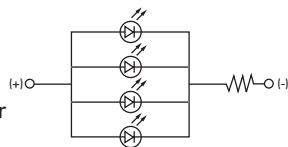

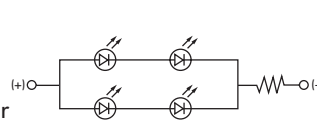

AT627  
12-volt  
4-element  
with Resistor

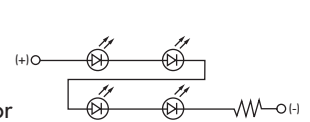

AT627  
24-volt  
4-element  
with Resistor



### Super Bright Single Element LED

<b>AT625G Blue</b> <b>AT631B White</b> <b>AT632F Green</b>      T-1 Bi-pin				Color	<b>6B</b>	<b>6F</b>	<b>6G</b>
				White	Green	Blue	
	Maximum Forward Current			$I_{FM}$	30mA	30mA	30mA
	Typical Forward Current			$I_F$	20mA	20mA	20mA
	Forward Voltage			$V_F$	3.3V	3.3V	3.3V
	Maximum Reverse Voltage			$V_{RM}$	7V	7V	7V
	Current Reduction Rate Above 25°C			$\Delta I_F$	0.40mA/°C	0.40mA/°C	0.40mA/°C
	Ambient Temperature Range				-25° ~ +50°C		

**No Code** No Lamp

### CAP TYPES & COLOR COMBINATIONS

Color Codes: B White C Red D Amber E Yellow F Green G Blue J Clear

#### Solid Cap for Incandescent Lamp & Nonilluminated

Lens/Filter

Colors Available:

- BJ**
- FJ**
- CJ**
- GJ**
- EJ**

AT4054

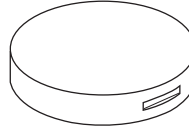
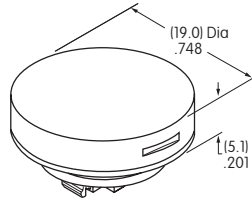

Translucent Colored Lens

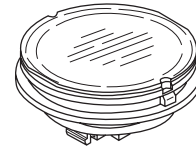

Transparent Clear Filter



Lamp AT607

Material: Polycarbonate Finish: Glossy

#### Insert Cap for Incandescent or Neon Lamp & Nonilluminated

Lens/Filter

Colors Available:

- JB**
- JF**
- JC**
- JG**
- JE**

AT4055

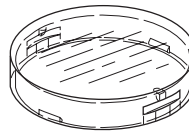
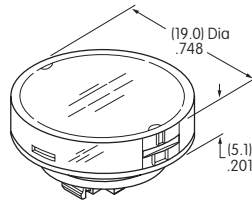

Transparent Clear Lens

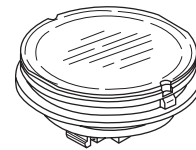

Translucent Colored Filter



Lamp AT607



Lamp AT607N

JF and JG not suitable with neon lamp.

Material: Polycarbonate Finish: Glossy

#### Cap for Bright LED without Resistor

Lens/Diffuser

Colors Available:

- JB**
- JC**
- JD**
- JF**

AT4179

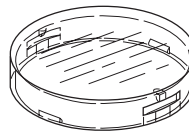
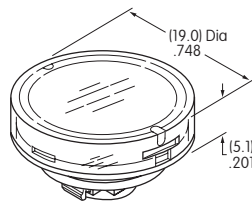

Transparent Clear Lens

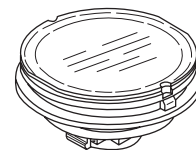

Translucent Colored Diffuser



Bright LED AT635

Material: Polycarbonate Finish: Glossy

#### Cap for Bright LED with Resistor

Lens/Diffuser

Colors Available:

- JB**
- JC**
- JD**
- JF**

AT4165

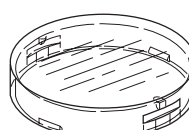
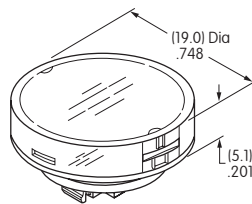

Transparent Clear Lens

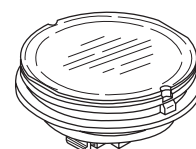

Translucent Colored Diffuser

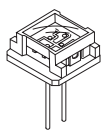

Bright LED AT627

Material: Polycarbonate Finish: Glossy

## CAP TYPES & COLOR COMBINATIONS

### Cap for Super Bright LEDs

**JB** Clear Lens  
White Diffuser

Material:  
Polycarbonate  
Finish: Glossy

AT4131

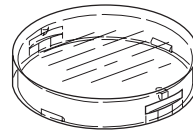
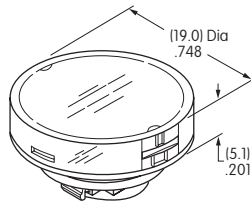

Transparent  
Clear Lens

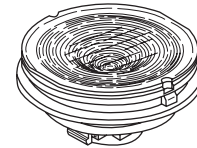

Translucent  
Colored Diffuser



LEDs  
AT625  
AT631  
AT632

## TYPICAL SWITCH DIMENSIONS

### Single & Double Pole

### Panel Seal

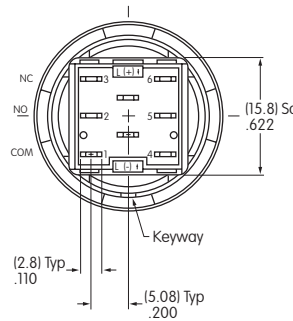
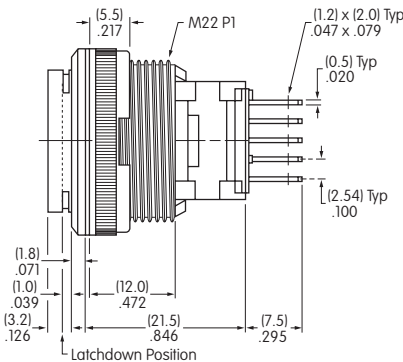
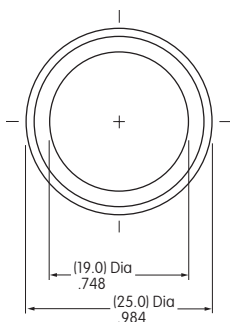

Single pole models do not have terminals 4, 5, & 6.

**LB25WKW01-12-JC**

## OPTIONAL ACCESSORIES

### AT9410 Splash Cover for Panel Seal

Materials:  
Lid: PVC (loses pliability below 0°C/32°F)  
Base: Polyethylene  
O-ring: NBR

Recommended Panel Thickness:  
.039" ~ .138" (1.0mm ~ 3.5mm)

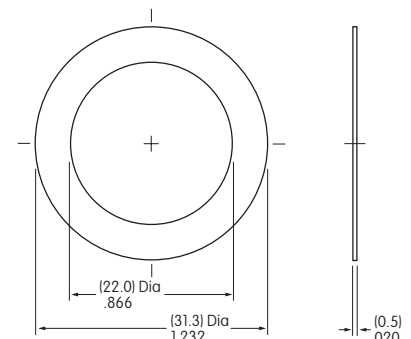
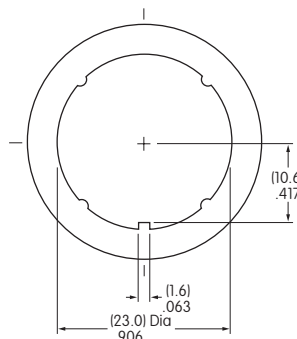
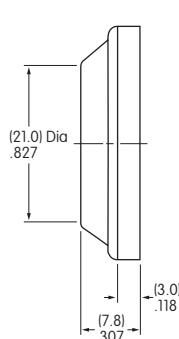
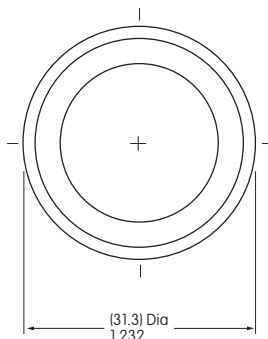
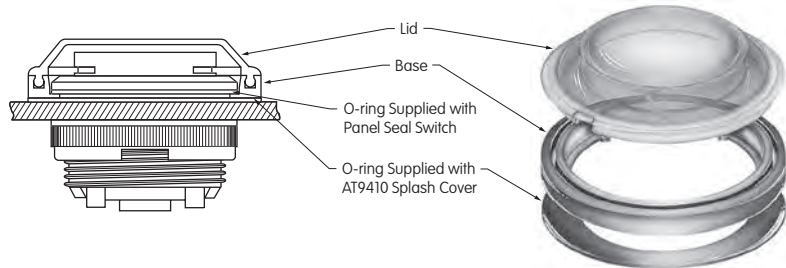

## ASSEMBLY INSTRUCTIONS

### Lamp Installation & LED Orientation

#### Incandescent & Neon Lamps AT607 & AT607N

Align projections on lamp with grooves (B) in holder when inserting lamp. To correctly join the lamp holder and cap base, match the cut corners (A).

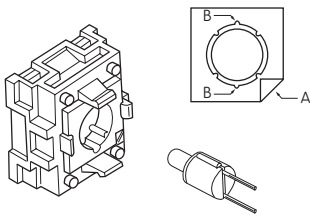

#### Bright LED AT627 Panel Seal Models

For panel seal models, Bright LED must first be inserted into the lamp socket which is built into the switch. The cap can then be placed on the switch.

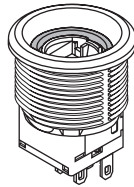

#### Bright LED AT627 Snap-in Models

For snap-in models, Bright LED must be inserted into the cap first. Align cut corners (C) when inserting the LED.

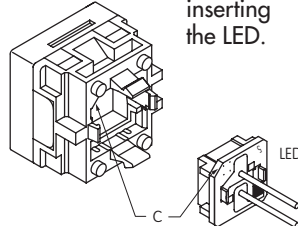

#### Bright & Super Bright LEDs AT625, AT631, AT632, AT635

Align D-flat on LED with flat (B) in holder when inserting the LED. To correctly join the lamp holder and cap base, match the cut corners (A).

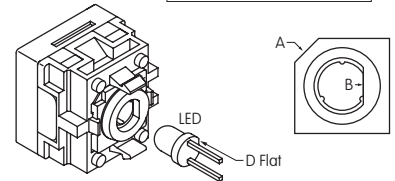

### Switch & Cap Assembly

#### Round & Rectangular

Match clip on cap assembly with receptacle inside switch. Lamp terminals will then be aligned correctly with lamp socket.

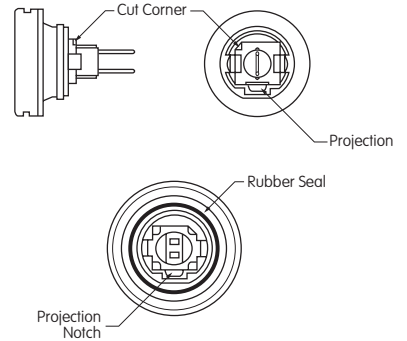

#### Square

Match projection (C) on cap assembly with groove (C) inside switch. Lamp terminals will then be aligned correctly with lamp socket.

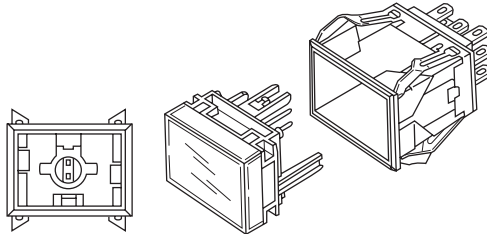

#### Panel Seal

With Lamps AT607, AT607N, and LEDs AT614, AT625, AT631, AT632: Match projection on cap assembly with notch inside switch. Lamp terminals will then be aligned correctly with lamp socket.

### Installation & Maintenance

#### Snap-in Mount

Snap-in clip holds all switches firmly in place. To mount round switch, match the antirotation projection on switch with guide cut in panel. Snap into panel cutout.

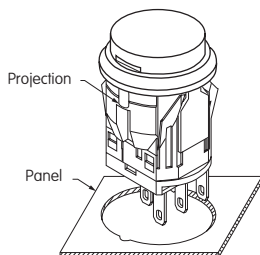

#### Panel Seal Bushing Mount

Insert switch from the front of the panel with the o-ring between the built-in bezel and the panel. Install mounting nut AT075 (supplied with switch) from the rear of the panel. Overtightening mounting nut may damage the switch housing.

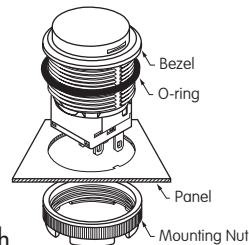

#### Lamp Replacement

Actuator must be in UP position. Pull off cap with cap extractor AT109. Replace lamp and reassemble as shown above.



AT109  
Cap Extractor



AT112  
Socket Wrench

Toggles  
Rockers  
Pushbuttons  
Illuminated PB  
D  
Programmable  
Keylocks  
Rotaries  
Slides  
Tactiles  
Tilt  
Touch  
Indicators  
Accessories  
Supplement

## LEGENDS

NKK Switches can provide custom legends for caps. Contact factory for more information.

### Suggested Printable Area for Lens

**Recommended Methods:** Laser Etch on clear lens, Screen Print, or Pad Print on lens.  
Epoxy based ink is recommended.

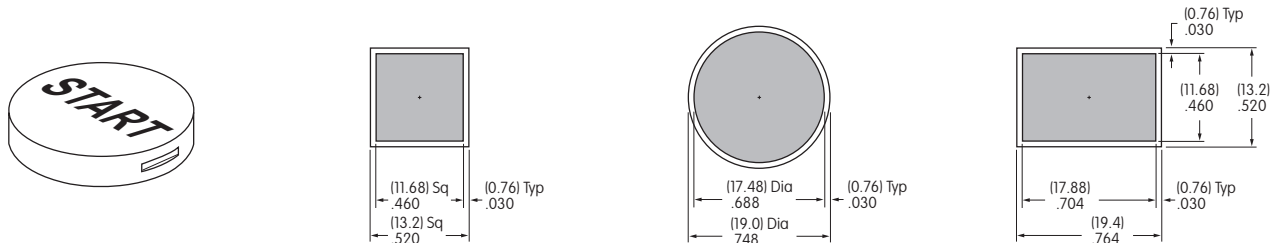

Shaded areas are printable areas.

### Suggested Printable Area for Film Insert

**Recommended Print Method:** Laser Print or Screen Print with Epoxy based ink

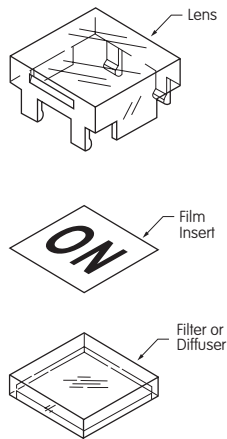

Film Insert: Clear Polyester, 4 mil max. thickness

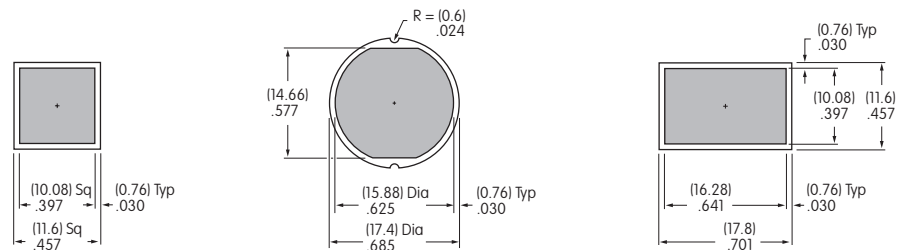

Shaded areas are printable areas.

# General Specifications

## Electrical Capacity (Resistive Load)

**Power Level (silver):** 3A @ 125V AC or 3A @ 250V AC or 3A @ 30V DC

## Other Ratings

**Contact Resistance:** 50 milliohms maximum  
**Insulation Resistance:** 200 megohms minimum @ 500V DC  
**Dielectric Strength:** 1,000V AC minimum between contacts for 1 minute minimum  
 1,500V AC minimum between contacts and case for 1 minute minimum  
**Mechanical Life:** 500,000 operations minimum  
**Electrical Life:** 50,000 operations minimum for 3A @ 125V/250V AC & 3A @ 30V DC  
 100,000 operations minimum for 1A @ 125V/250V AC & 1A @ 30V DC  
**Nominal Operating Force:** 1.5N for Single Pole; 3.0N for Double Pole  
**Contact Timing:** Nonshorting (break-before-make)  
**Travel:** Total Travel .118" (3.0mm)

## Materials & Finishes

**Actuator:** Polycarbonate  
**Housing:** Bushing mount: Glass fiber reinforced polyamide (UL94V-0);  
 Snap in mount: Polybutylene terephthalate (PBT) (UL94V-0)  
**Base:** Glass fiber reinforced polyamide (UL94V-0)  
**Movable Contact:** Phosphor bronze & silver with silver plating  
**Stationary Contacts:** Common terminal: Phosphor bronze with silver plating;  
 Contact terminals: Phosphor bronze with tin & copper plating  
**Lamp Terminals:** Phosphor bronze with tin and copper plating

## Environmental Data

**Operating Temperature Range:** -10°C through +50°C (+14°F through +122°F) for Illuminated  
 -25°C through +70°C (+13°F through +158°F) for Nonilluminated  
**Humidity:** 90 ~ 95% humidity for 240 hours @ 40°C (104°F)  
**Vibration:** 10 ~ 55Hz with peak-to-peak amplitude of 1.5mm traversing the frequency range & returning in 1 minute; 3 right angled directions for 2 hours  
**Shock:** 50G (490m/s<sup>2</sup>) acceleration (tested in 6 right angled directions, with 5 shocks in each direction)

## Installation

**Mounting Torque:** 0.8Nm (7.08 lb•in)  
**Soldering Time & Temperature:** Manual Soldering: See Profile A in Supplement section.  
**Cleaning:** Hand clean locally with alcohol based solution

## Standards & Certifications

**Flammability Standards:** UL94V-0 housing & base  
**UL:** **File No. E44145 - Recognized only when ordered with marking on switch.**  
 Add "/U" or "/CUL" to end of part number to order UL recognized switch.  
 All single & double pole models recognized at 3A @ 125V/250V AC or 3A @ 30V DC.

# Distinctive Characteristics

Environmentally friendly components and packaging materials meet RoHS Directive restricting use of hazardous materials. Suited for lead-free soldering because of heat resistant resin materials.

Smooth, slightly concave surface of cap designed to fit fingertip. Unique design and construction of cap prevents its removal and limits tampering.

Bright LED illumination in choice of red, green, or amber through translucent white cap.

Short body of .551" (14.0mm) conserves behind-panel space.

Combination solder lug and .110" quick connect terminals.

Crisp actuation and clear circuit status provided by snap-action contact mechanism. Arc barrier between movable contacts protects against crossover.

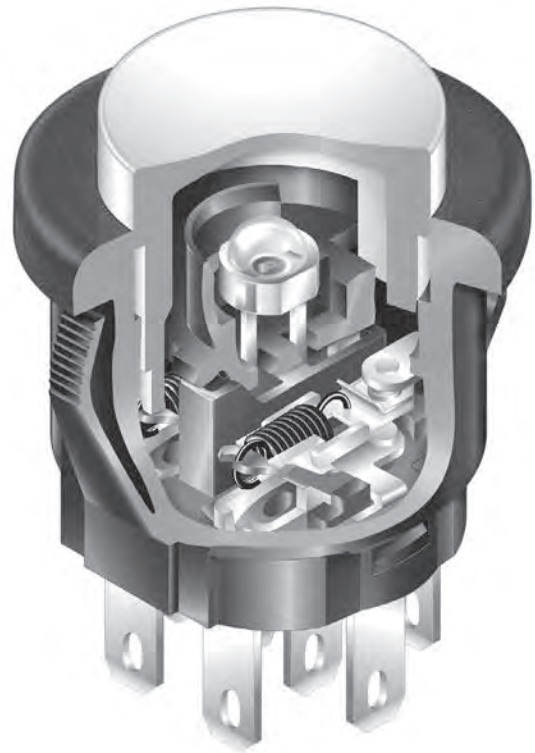

Actual Size

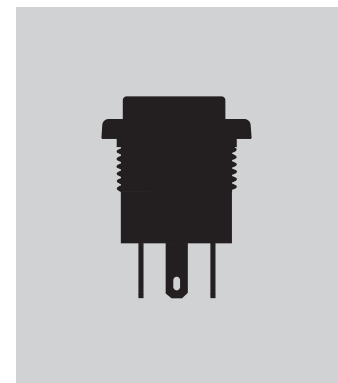

### TYPICAL SWITCH ORDERING EXAMPLE

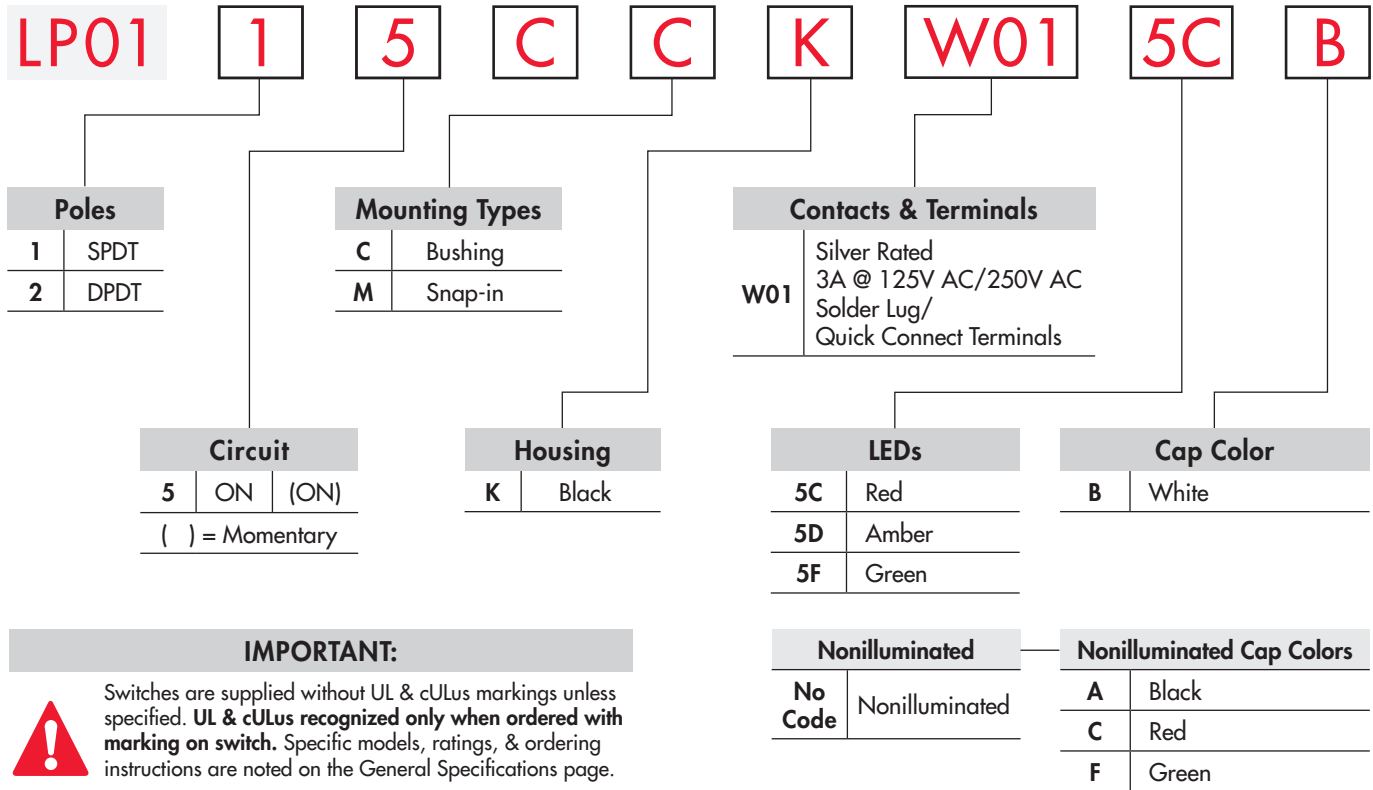

### DESCRIPTION FOR TYPICAL ORDERING EXAMPLE

#### LP0115CCKW015CB

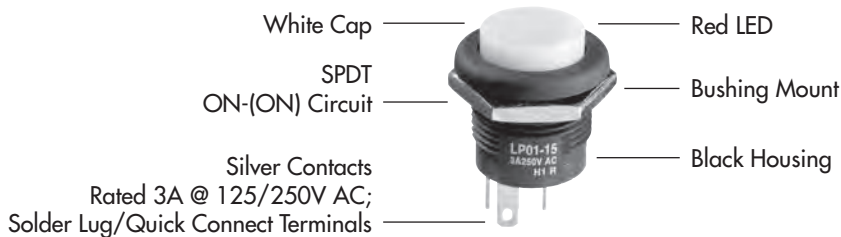

### POLES & CIRCUIT

Pole	Model	Plunger Position ( ) = Momentary		Connected Terminals		Throw & Power/Lamp Schematics
		Normal	Down	Normal	Down	
SP	LP0115	ON	(ON)	1-3	1-2	Note: Terminal markings "COM, NO, NC, L, + and -" are actually on the switch; terminal numbers are not on the switch. 
DP	LP0125	ON	(ON)	1-3 4-6	1-2 4-5	



## MOUNTING TYPES

**C**

**Bushing**

.630" (16.0mm) Diameter

This mounting option is supplied with a steel hexagon nut with nickel plating.



**M**

**Snap-in**

.669" (17.0mm) Diameter



Recommended Panel Thickness:  
.079" ~ .256"  
(2.0mm ~ 6.5mm)

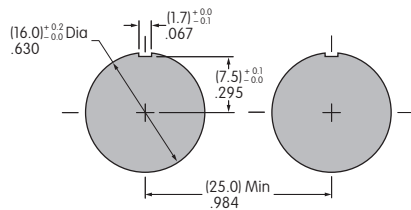

Allow .984" (25.0mm) distance from center-to-center between switches when mounted side-by-side.

Recommended Panel Thickness:  
.039" ~ .126"  
(1.0mm ~ 3.2mm)

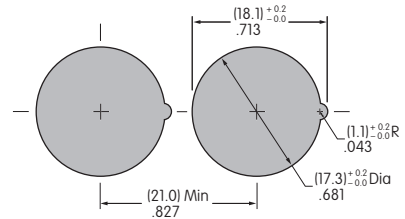

Allow .827" (21.0mm) distance from center-to-center between switches when mounted side-by-side.

## HOUSING

**K**

**Black**

Housing available in black only. The one-piece body and bezel have a matte finish.

## CONTACT MATERIALS, RATINGS, & TERMINALS

**W01**

**Silver**

**Power Level**

3A @ 125V AC/250V AC; 3A @ 30V DC

**Solder Lug/**

**.110" (2.8mm) Quick Connect**

Note: If used at 1A @ 125V AC/250V AC or 1A @ 30V DC, electrical life will be 100,000 operations minimum.

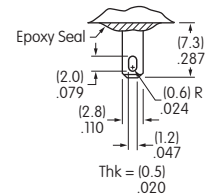

## LED COLORS & SPECIFICATIONS

The electrical specifications shown are determined at a basic temperature of 25°C. LED circuit is isolated and requires external power source. Polarity marks are on the switch.

If the source voltage exceeds the rated voltage, a ballast resistor is required.

The resistor value can be calculated by using the formula in the Supplement section.

LEDs are an integral part of the switch and are not available separately.	Single Color LED with 1 Element		<b>5C</b>	<b>5D</b>	<b>5F</b>
		Colors	Red	Amber	Green
	Maximum Forward Current	$I_{FM}$	30mA	30mA	30mA
	Typical Forward Current	$I_F$	20mA	20mA	20mA
	Forward Voltage	$V_F$	1.95V	2.0V	2.1V
	Maximum Reverse Voltage	$V_{RM}$	5V	5V	5V
	Current Reduction Rate Above 25°C	$\Delta I_F$	0.41mA/°C	0.29mA/°C	0.39mA/°C
	Ambient Temperature Range		-10°C ~ +50°C		

**No Code**

No Lamp

## CAP COLORS

### Illuminated Cap

Cap Color Available:



**White**

The translucent cap is an integral part of the switch and is not available separately.

Material: Polycarbonate

Finish: Matte



### Nonilluminated Caps

Cap Colors Available:



**Black**



**Red**



**Green**

The cap is an integral part of the switch and is not available separately.

Material: Polycarbonate

Finish: Matte



## TYPICAL SWITCH DIMENSIONS

### Bushing Mount • Single Pole



LP0115CCKW015CB

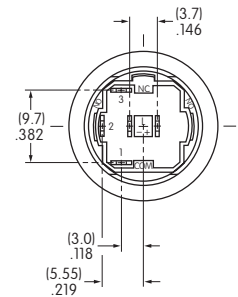
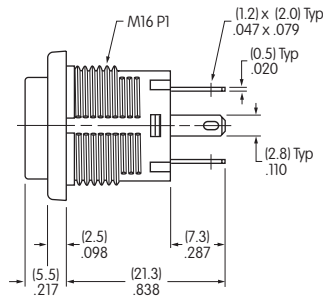
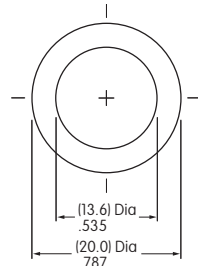

### Bushing Mount • Double Pole



LP0125CCKW015CB

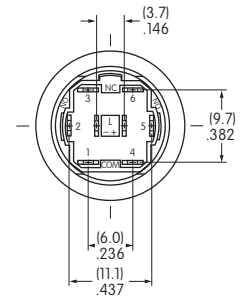
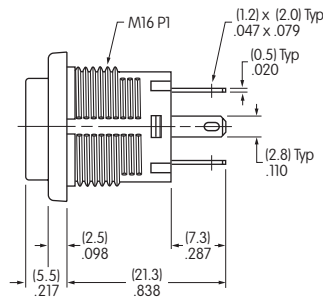
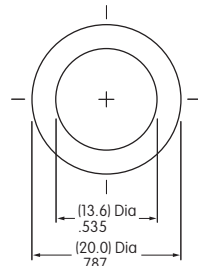

### Snap-in • Single Pole



LP0115CMKW015CB

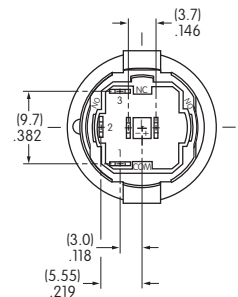
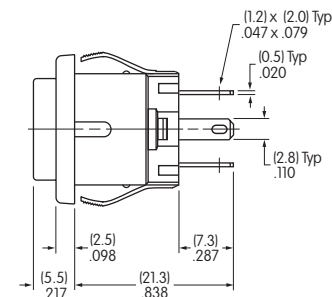
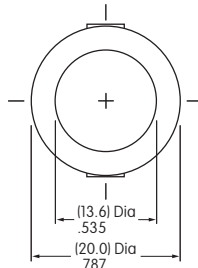

### Snap-in • Double Pole



LP0125CMKW015DB

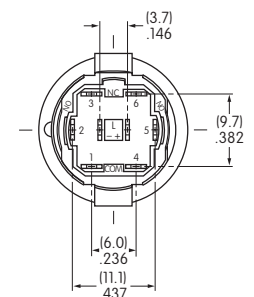
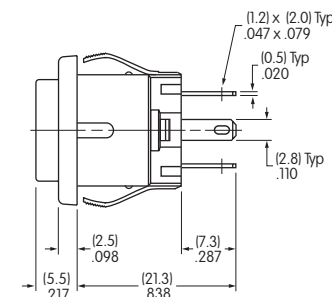
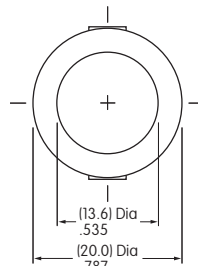

OPTIONAL ACCESSORIES

Adaptors

AT716  
Single Pole  
Solder Lug/  
Quick Connect  
Terminals

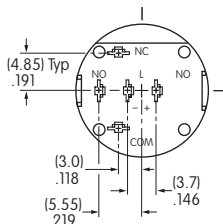
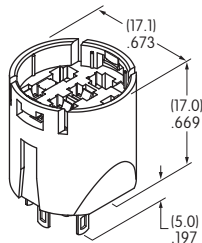

AT717  
Double Pole  
Solder Lug/  
Quick Connect  
Terminals

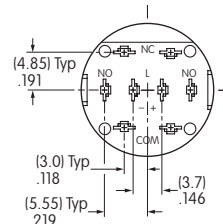
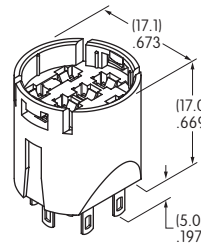

AT718  
Single Pole  
Straight PC  
Terminals

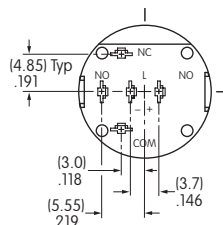
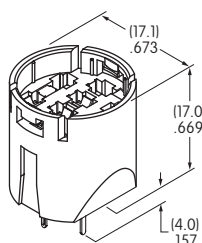

AT719  
Double Pole  
Straight PC  
Terminals

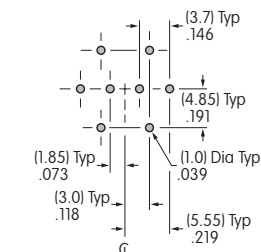
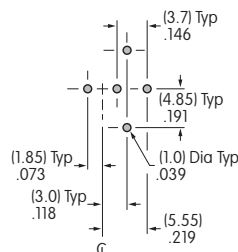
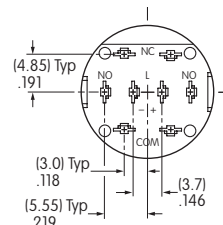
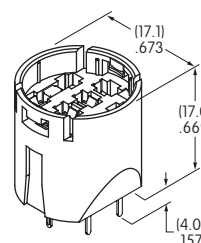

Material: Glass fiber reinforced polyamide Note: Order adaptors separately

Switch Dimensions Shown with Adaptor AT716

Dimension A: Solder Lug .197" (5.0mm); Straight PC .157" (4.0mm)  
Panel thickness for LP01 Bushing Mount: .079" ~ .256" (2.0mm ~ 6.5mm)

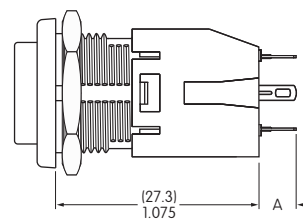

LEGENDS

NKK Switches can provide custom legends for caps. Contact factory for more information.

Suggested Printable Area for LP01 Cap



Recommended Methods:

Pad Print or Laser Etch on cap.  
Epoxy based ink is recommended.

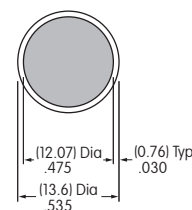

Shaded area is printable area

# General Specifications

## Electrical Capacity (Resistive Load)

**Logic Level:** 0.4VA maximum @ 28V AC/DC maximum  
(Applicable Range 0.1 mA ~ 0.1 A @ 20mV ~ 28V)

## Other Ratings

**Contact Resistance:** 50 milliohms maximum  
**Insulation Resistance:** 500 megohms minimum @ 250V DC  
**Dielectric Strength:** 250V AC minimum between contacts for 1 minute minimum  
**Mechanical Life:** 500,000 operations minimum  
**Electrical Life:** 500,000 operations minimum  
**Nominal Operating Force:** **Standard:** 1.5N ±0.5 Newtons  
**High:** 2.5N ±0.8 Newtons  
**Stroke:** 1.5mm (.059")

## Materials & Finishes

**Actuator:** Silicon rubber  
**Case:** Polycarbonate resin  
**Base:** Glass fiber reinforced polyamide resin  
**Movable Contact:** Silver over nickel with gold plating  
**Stationary Contacts:** Brass with gold plating  
**Switch Terminals:** Brass with gold plating

## Environmental Data

**Operating Temperature Range:** -25°C through +50°C (-13°F through +122°F) for Illuminated  
 -25°C through +70°C (-13°F through +158°F) for Nonilluminated  
**Humidity:** 90 ~ 95% humidity for 96 hours @ 40°C (104°F)  
**Vibration:** 10 ~ 55Hz with peak-to-peak amplitude of 1.5mm traversing the frequency range & returning in 1 minute; 3 right angled directions for 2 hours  
**Shock:** 50G (490m/s<sup>2</sup>) acceleration (tested in 6 right angled directions, with 5 shocks in each direction)

## Installation

**Cap Installation Force:** 5.0N maximum downward force on actuator

## PCB Processing

**Soldering:** Wave Soldering: 270°C maximum @ 6 seconds maximum  
 Manual Soldering: 390°C maximum @ 4 seconds maximum  
**Cleaning:** These devices are not process sealed. Hand clean locally using alcohol based solution.

## Standards & Certifications

The NP01 Series pushbuttons have not been tested for UL recognition or CSA certification. These switches are designed for use in a low-voltage, low-current, logic-level circuit. When used as intended in a logic-level circuit, the results do not produce hazardous energy.

# Distinctive Characteristics

Soft touch actuation achieved by mechanical silicon rubber structure.

Distinct, long stroke of 1.5mm (.059").

Entire cap is fully illuminated with single or bicolor LED.

Compact design with dimension of 12.5mm (.492") from PC board to top of cap.

Alternating legend options with bicolor LED.

Available in both high (2.5N) or standard (1.5N) operating force.

Gold plated contacts provide high reliability.

Crimped terminals ensure secure PC mounting and prevent dislodging during soldering.

Molded-in terminals prevent entry of flux, solvents, and other contaminants.

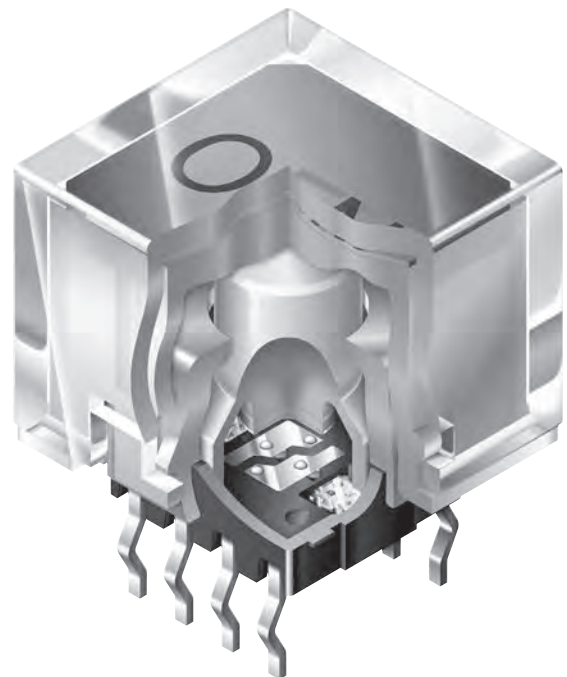

Actual Size

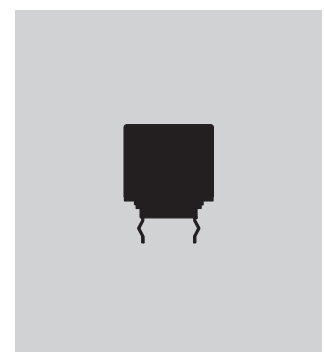

# Series NP01

## Subminiature Smooth Actuation Pushbuttons

### TYPICAL SWITCH ORDERING EXAMPLE

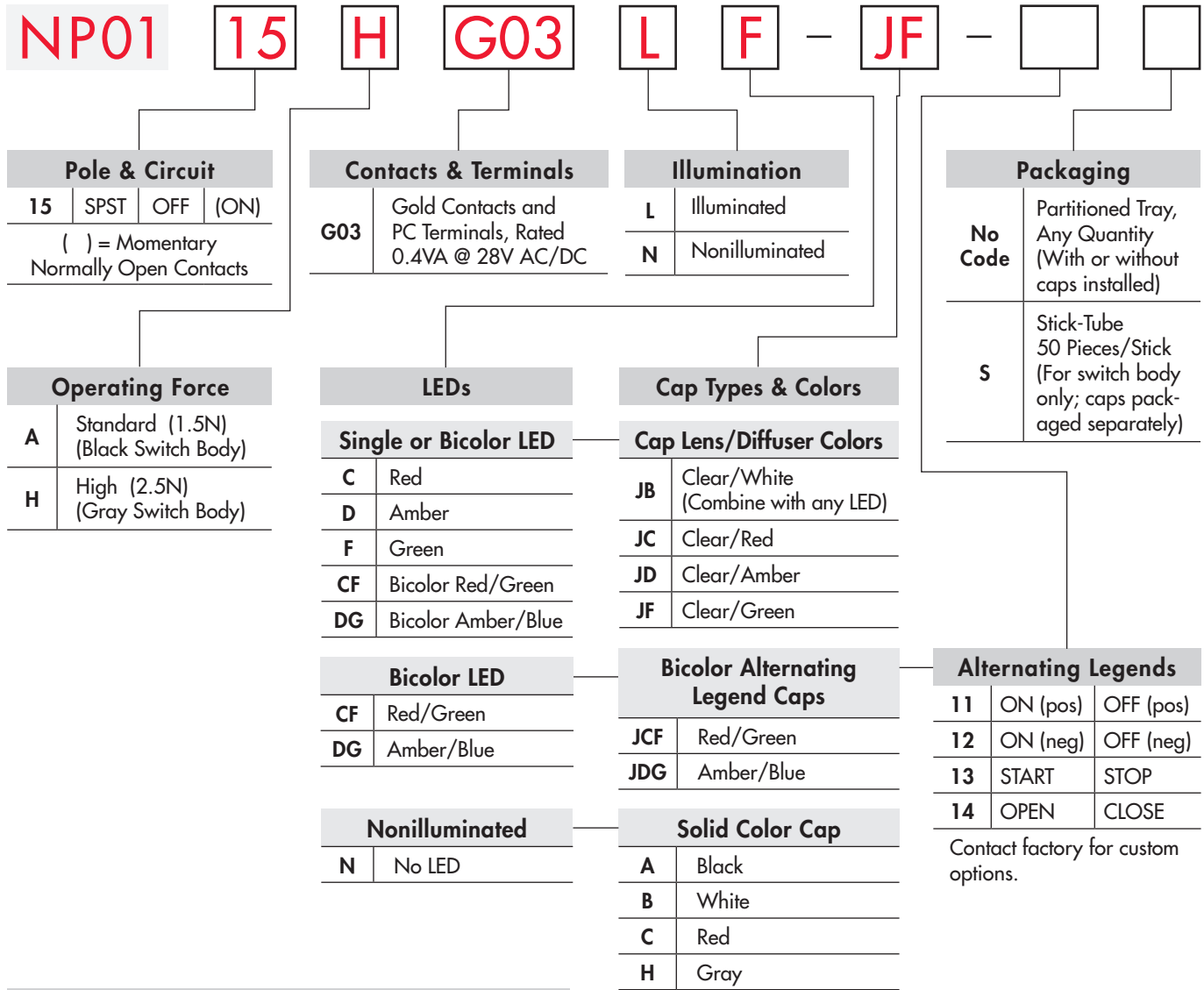

Part Numbers for Alternating Legends	
Color	Part Number
Red/Green	AT3023JCF11 ~ AT3023JCF14
Amber/Blue	AT3023JDG11 ~ AT3023JDG14

Refer to Ordering Table for Alternating Legend that corresponds with last 2 digits of part number.

### DESCRIPTION FOR TYPICAL ORDERING EXAMPLE

#### NP0115HG03LF-JF

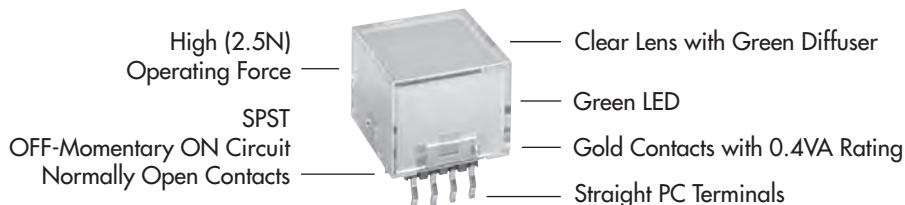

## POLE & CIRCUIT

### Illuminated Models

Pole	Model	Plunger Position ( ) = Momentary		Connected Terminals		Throw & Switch Schematic
		Normal	Down			
SP	NP0115AG03L NP0115HG03L	OFF 	(ON) 	Normally Open 	1-2 	Notes: Switch is marked with LC1, 1, L3, L4, L1, L2, 2, LC2. Lamp circuit is isolated and requires an external power source. 

### Nonilluminated Models

Pole	Model	Plunger Position ( ) = Momentary		Connected Terminals		Throw & Switch Schematic
		Normal	Down			
SP	NP0115AG03N NP0115HG03N	OFF 	(ON) 	Normally Open 	1-2 	Note: Switch is marked with LC1, 1, L3, L4, L1, L2, 2, LC2. 

## OPERATING FORCE

**A** Standard Nominal Operating Force  
1.5 ±0.5N  
Switch base is Black

**H** High Nominal Operating Force  
2.5 ±0.8N  
Switch base is Gray

## CONTACTS, TERMINALS, & RATING

**G03** Gold Contacts      Straight PC Terminals      0.4VA maximum @ 28V AC/DC maximum

## ILLUMINATION

**L** Illuminated

**N** Nonilluminated

### LED COLORS & SPECIFICATIONS

LEDs are an integral part of the switch and not available separately. The electrical specifications shown are determined at a basic temperature of 25°C.

If the source voltage exceeds the forward voltage, a ballast resistor is required. Specifications in parentheses ( ) below for Bicolor LED denote simultaneous illumination of Red and Green.

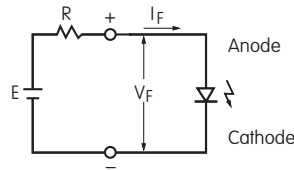

$$R = \frac{E - V_F}{I_F}$$

Where: R = Resistor Value (Ohms)  
E = Source Voltage (V)  
V<sub>F</sub> = Forward Voltage (V)  
I<sub>F</sub> = Forward Current (A)



	Single Color LED			Bicolor LED			
	<b>C</b> Red	<b>D</b> Amber	<b>F</b> Green	<b>CF</b> Red Green	<b>DG</b> Amber Blue		
Maximum Forward Current I <sub>FM</sub>	30mA	30mA	25mA	30 (25)mA	25 (25)mA	30mA	30mA
Typical Forward Current I <sub>F</sub>	20mA	20mA	16mA	20 (20)mA	16 (5)mA	20mA	20mA
Forward Voltage V <sub>F</sub>	1.95V	2.0V	3.3V	1.95V	3.3V	2.0V	3.2V
Maximum Reverse Voltage V <sub>RM</sub>	5V	5V	5V	5V	5V	5V	5V
Current Reduction Rate ΔI <sub>F</sub>	0.41mA/°C above 25°C	0.38mA/°C above 25°C	0.33mA/°C above 25°C	0.40mA/°C above 25°C	0.33mA/°C above 25°C	0.40mA/°C above 25°C	0.40mA/°C above 25°C
Ambient Temperature Range	-25° ~ +50°C			-25° ~ +50°C			

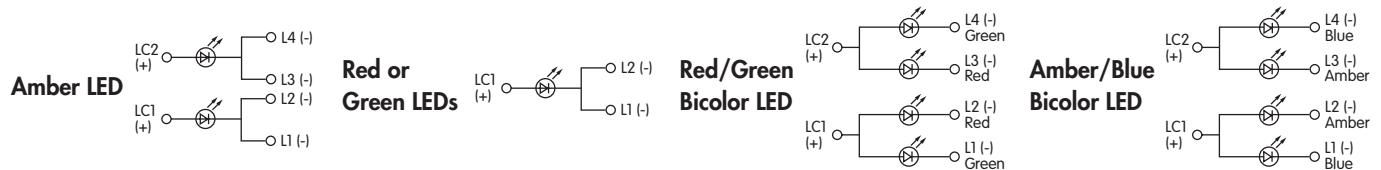

### CAP TYPES & COLORS

**AT3022**  
12mm Square Cap

Material:  
Polycarbonate Resin

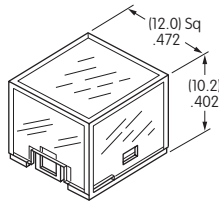

Cap for Single or Bicolor LED

**JB**

Clear Lens/White Diffuser

**JC**

Clear Lens/Red Diffuser

**JD**

Clear Lens/Amber Diffuser

**JF**

Clear Lens/Green Diffuser

**AT3023**  
12mm Square Cap

Material:  
Polycarbonate Resin

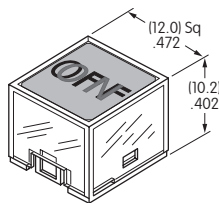

Alternating Legend Cap for Bicolor LED

**JCF**

Red/Green

**JDG**

Amber/Blue

Clear Lens

Alternating Legend Filter

### Standard Alternating Legend Pairs



Cap illumination is alternating Green/Red or Blue/Amber; legend text is black.

Contact factory for other Alternating Legends.

Legend illustrations are approximate representations of the actual characters on the filters.



## CAP TYPES & COLORS (CONTINUED)

### AT3024 12mm Square Cap

Material:  
Polycarbonate Resin

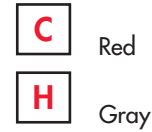
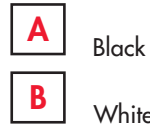
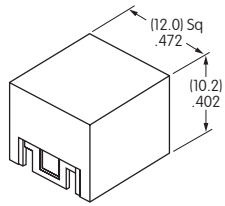

## TYPICAL SWITCH DIMENSIONS

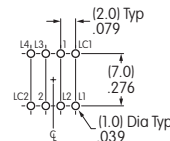
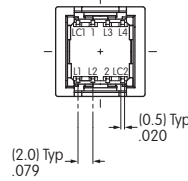
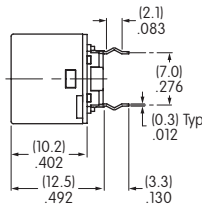
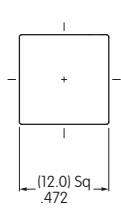

### Illuminated • Straight PC



NP0115HG03LF-JF

## PACKAGING



### Partitioned Tray

Any quantity. No code is required. Switches may be packaged with or without caps installed.



### Stick-Tube Packaging

50 pieces per stick

Switches must be ordered in 50-piece increments when stick-tube packaging is selected. This packaging is for the switch body only. Caps will be packaged separately.

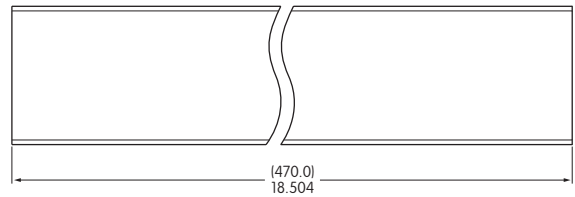
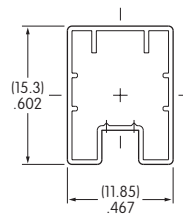

## LEGEND ORIENTATION

Top View

Bottom View

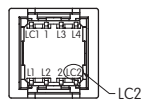

Orient cap with legend as shown here, and "LC2" at lower right of switch body. Orders for switches with legends will be assembled as illustrated.

## PRECAUTIONS FOR HANDLING & STORAGE

- NP01 Pushbuttons are electrostatically sensitive. To prevent damage to LED, devices must be properly isolated from static electricity.
  - Once the cap is installed onto the switch body, it cannot be removed.
  - When assembling cap, align projection on switch body to slot on inside of cap. (Refer to illustration at right.)
  - \* Legends may be printed on the lens with laser etch, screen print or pad print methods. Epoxy based ink is recommended.
  - Do not use excessive force during installation on PC board or for cap installation.
- \* NKK Switches can provide custom legends for caps. Contact factory for more information.

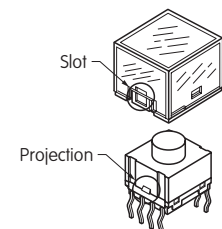

# General Specifications

## Electrical Capacity (Resistive Load)

**Power Level (silver):** 5A @ 125/250V AC or 5A @ 30V DC  
**Logic Level (gold):** 0.4VA maximum @ 28V AC/DC maximum  
 (Applicable Range 0.1mA ~ 0.1A @ 20mV ~ 28V)  
 Note: Find additional explanation of operating range in Supplement section.

## Other Ratings

**Contact Resistance:** 50 milliohms maximum for silver; 100 milliohms maximum for gold  
**Insulation Resistance:** 200 megohms minimum @ 500V DC  
**Dielectric Strength:** 1,000V AC minimum between contacts for 1 minute minimum;  
 1,500V AC minimum between contacts & case for 1 minute minimum  
**Mechanical Life:** 1,000,000 operations minimum for momentary;  
 200,000 operations minimum for alternate action  
**Electrical Life:** 10,000 operations minimum for silver;  
 100,000 operations minimum for silver with resistive load of 3A @ 125V AC  
 200,000 operations minimum for gold  
**Nominal Operating Force:** Single Pole: 1.9N for Square & 1.9N for Rectangular  
 Double Pole: 2.55N for Square & 3.1N for Rectangular  
**Contact Timing:** Break before make  
**Travel:** Pretravel .067" (1.7mm); Overtravel .024" (0.6mm); Total Travel .091" (2.3mm)

## Materials & Finishes

**Housing/Bezel:** Glass fiber reinforced polyamide (UL94V-0)  
**Snap-in Frame:** Stainless steel  
**Movable Contactor:** Phosphor bronze  
**Movable Contacts:** Silver alloy or copper with gold plating  
**Stationary Contacts:** Silver alloy or copper with gold plating  
**Switch Terminals:** Phosphor bronze with silver or gold plating  
**Lamp Terminals:** Brass with silver plating  
**Base:** Glass fiber reinforced liquid crystal polymer (UL94V-0)

## Environmental Data

**Operating Temperature Range:** -25°C through +50°C (-13°F through +122°F) for Illuminated  
 -20°C through +70°C (-4°F through +158°F) for Nonilluminated  
**Humidity:** 90 ~ 95% humidity for 96 hours @ 40°C (104°F)  
**Vibration:** 10 ~ 55Hz with peak-to-peak amplitude of 1.5mm traversing the frequency range & returning  
 in 1 minute; 3 right angled directions for 2 hours  
**Shock:** 50G (490m/s<sup>2</sup>) acceleration (tested in 6 right angled directions, with 5 shocks in each direction)

## Installation

**Cap Installation Force:** 7.55N (1.70 lbf) maximum downward force on cap  
**Soldering Time & Temp:** Wave Soldering (PC version): See Profile A in Supplement section.  
 Manual Soldering: See Profile A in Supplement section.  
**Cleaning:** These devices are not process sealed. Hand clean locally using alcohol based solution.

## Standards & Certifications

**Flammability Standards:** UL94V-0 housing/bezel & base  
**UL:** **File No. E44145 - Recognized only when ordered with marking on switch.**  
 Add "/U" or "/CUL" before dash in part number to order UL recognized switch.  
 UL recognized only when ordered switch body with cap assembled.  
 All single & double pole models recognized at 5A @ 125/250V AC or 0.014A @ 28V DC.  
**CSA:** **File No. 023535\_0\_000 - Certified only when ordered with marking on switch.**  
 Add "/C" before dash in part number to order CSA certified switch.  
 All single & double pole models certified at 5A @ 125/250V AC or 5A @ 30V DC or  
 0.4VA maximum @ 28V AC/DC maximum.

# Distinctive Characteristics

Red/green and amber/blue bicolors with alternating standard or custom legends.  
Super bright LED provides brilliant uniform illumination.

Bright or super bright LEDs (an integral part of the switch) of red, amber, green, blue, or white, in full face or spot illumination plus square or rectangular models.

Combination of PCB mountability and short body allows use in compact applications.

Small behind panel dimension for snap-in mounting in tight spaces.

Snap-acting contact mechanism provides sensitive actuation with audible feedback; quick-make, quick-break characteristic limits arcing and prolongs electrical life.

Latchdown mechanism, independent of switching mechanism, gives visible and tactile indication of circuit status.

Terminals are epoxy sealed to lock out flux, solvents, and other contaminants.

Momentary and alternate action circuits available in the same space-saving body size.

Matching indicators available.

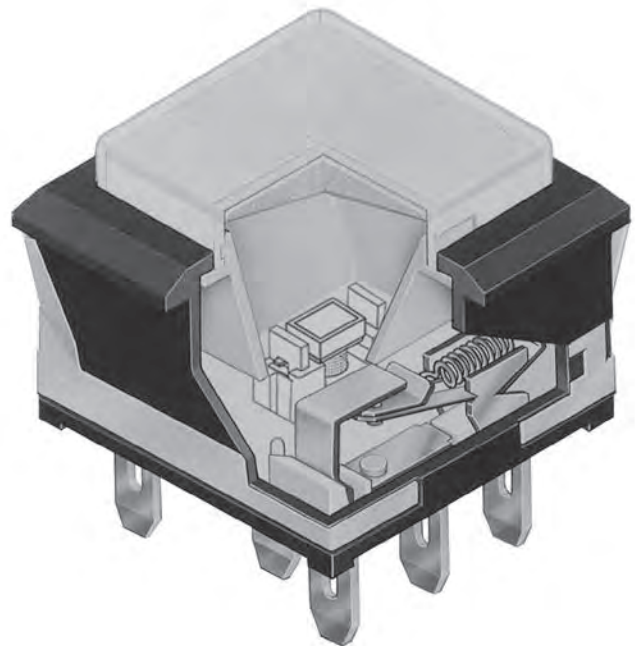

Actual Size

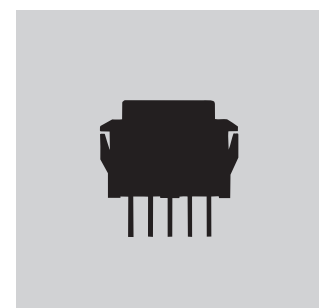

- Toggle
- Rockers
- Pushbuttons
- D Illuminated PB**
- Programmable
- Key locks
- Rotaries
- Slides
- Tactiles
- Tilt
- Touch
- Indicators
- Accessories
- Supplement

### TYPICAL SWITCH

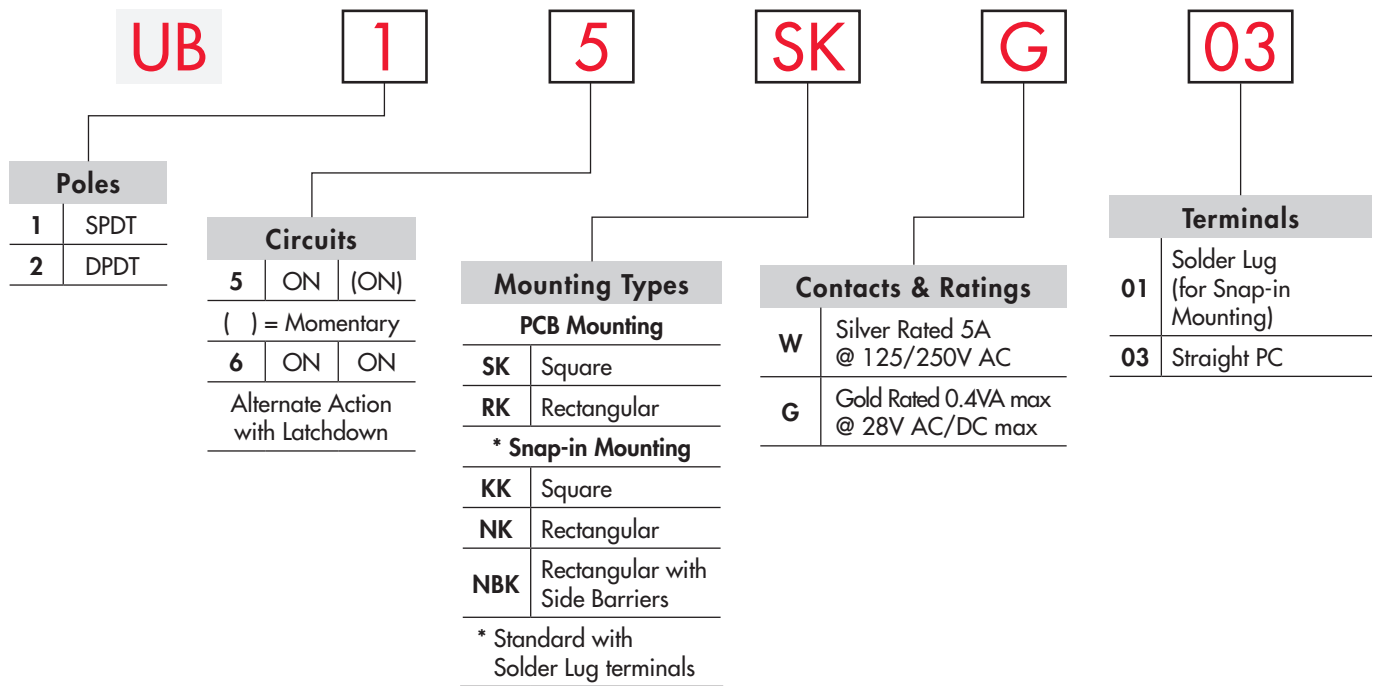

#### IMPORTANT:

Switches are supplied without UL, cULus & CSA marking unless specified. **UL, cULus & CSA recognized only when ordered with marking on the switch.** Specific models, ratings, & ordering instructions are noted on General Specifications page.



#### DESCRIPTION FOR TYPICAL ORDERING EXAMPLE

#### UB15SKG035C-CC

Gold Contacts with 0.4VA Rating  
Square with PCB Mounting



Red, Bright LED & Red Lens with Red Diffuser  
SPDT ON-(ON) Circuit  
Straight PC Terminals

## ORDERING EXAMPLE

5C

LEDS	
Bright LED	
<b>5C</b>	Red
<b>5D</b>	Amber
<b>5F</b>	Green

Super Bright LED	
<b>6B</b>	White
<b>6F</b>	Green
<b>6G</b>	Blue

Super Bright Bicolor LED	
<b>6CF</b>	Red/Green
<b>6DG</b>	Amber/Blue

Nonilluminated	
<b>N</b>	Nonilluminated

CC

Cap Types & Colors			
Full Face Illuminated Cap for Bright LED			
Lens/Diffuser Colors			
<b>CB</b>	Red/White	<b>FF</b>	Green/Green
<b>CC</b>	Red/Red	<b>*FJ</b>	Green/Clear
<b>*CJ</b>	Red/Clear	<b>JB</b>	Clear/White
<b>DB</b>	Amber/White	<b>JC</b>	Clear/Red
<b>DD</b>	Amber/Amber	<b>JD</b>	Clear/Amber
<b>*DJ</b>	Amber/Clear	<b>JF</b>	Clear/Green
<b>FB</b>	Green/White	<b>*JJ</b>	Clear/Clear
<b>AB</b>	Square & Rectangular Spot Illuminated Black Cap with White Window		
* Not available with Rectangular cap			

Full Face Illuminated Cap for Super Bright LED	
<b>JB</b>	Clear Lens/White Diffuser
<b>AB</b>	Spot Illuminated Black Cap with White Window

Alternating Legend Cap/Diffuser	
<b>JCF</b>	Red/Green
<b>JDG</b>	Amber/Blue

Nonilluminated Cap Colors			
<b>A</b>	Black	<b>E</b>	Yellow
<b>B</b>	White	<b>F</b>	Green
<b>C</b>	Red	<b>G</b>	Blue

Alternating Legends		
<b>11</b>	ON (pos)	OFF (pos)
<b>12</b>	ON (neg)	OFF (neg)
<b>13</b>	START	STOP
<b>14</b>	OPEN	CLOSE

Part Numbers for Alternating Legends							
Square Alternating Legends				Rectangular Alternating Legends			
Color	Part Number	Color	Part Number	Color	Part Number	Color	Part Number
Red/Green	AT9450CF11	Amber/Blue	AT9450DG11	Red/Green	AT9451CF11	Amber/Blue	AT9451DG11
	AT9450CF12		AT9450DG12		AT9451CF12		AT9451DG12
	AT9450CF13		AT9450DG13		AT9451CF13		AT9451DG13
	AT9450CF14		AT9450DG14		AT9451CF14		AT9451DG14

Refer to Ordering Table for Alternating Legend that corresponds with last 2 digits of part number.

Toggles

Rockers

Pushbuttons

Illuminated PB

Programmable

Keylocks

Rotaries

Slides

Tactiles

Tilt

Touch

Indicators

Accessories

Supplement

## POLES & CIRCUITS

Pole	Model	Plunger Position ( ) = Momentary		Connected Terminals		Throw & Switch/Lamp Schematics
		Normal	Down	Normal	Down	
SP	UB15 *UB16	ON ON	(ON) ON	1-3	1-2	Notes: Switch is marked with NC, NO, COM, L+ & L-. Lamp circuit is isolated and requires an external power source. 
DP	UB25 *UB26	ON ON	(ON) ON	1-3 4-6	1-2 4-5	

\* When in latched position for the alternate circuit, cap position is .039" (1.0mm) above the housing.

## MOUNTING TYPES & SHAPES

### PCB Mounting

**SK**

Square

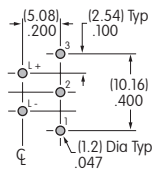

Single Pole

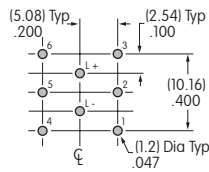

Double Pole

**RK**

Rectangular

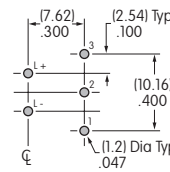

Single Pole

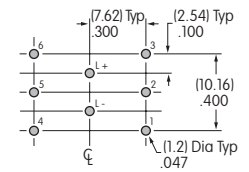

Double Pole

### Snap-in Mounting (Solder Lug)

**KK**

Square with Built-in Bezel

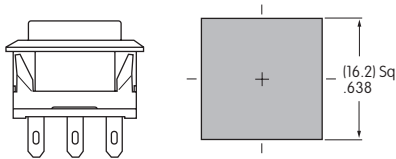

**NK**

Rectangular with Built-in Bezel

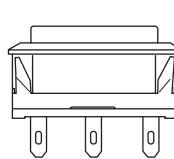

**NBK**

Rectangular with Built-in Side Barriers

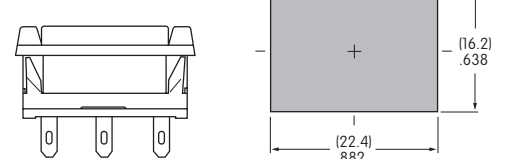

Snap-in Mounting with Solder Lug terminals is the standard combination. Panel Thickness: .039 ~ .126" (1.0 ~ 3.2mm)

## CONTACT MATERIALS & RATINGS

**W**

Silver Contacts

Power Level

5A @ 125V AC & 250V AC

**G**

Gold Contacts

Logic Level

0.4VA maximum @ 28V AC/DC maximum

Complete explanation of operating range in Supplement section.

## TERMINALS

**01**

Solder Lug

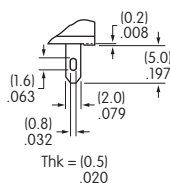

**03**

Straight PC

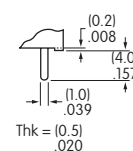

## BRIGHT & SUPER BRIGHT LED COLORS & SPECIFICATIONS

The electrical specifications shown are determined at a basic temperature of 25°C. LED circuit is isolated and requires external power source. Polarity marks are on bottom of switch. If the source voltage exceeds the rated voltage, a ballast resistor is required. Resistor value can be calculated by using the formula in the Supplement section. LED is an integral part of switch and not available separately.

Super Bright LEDs are Electrostatic Sensitive	 <b>ATTENTION</b> ELECTROSTATIC SENSITIVE DEVICES	Bright			Super Bright			Unit
		5C	5D	5F	6B	6F	6G	
Color		Red	Amber	Green	White	Green	Blue	
Maximum Forward Current	$I_{FM}$	30	30	25	30	30	30	mA
Typical Forward Current	$I_F$	20	20	20	20	20	20	mA
Forward Voltage	$V_F$	1.85	2.0	2.1	3.2	3.2	3.2	V
Maximum Reverse Voltage	$V_{RM}$	5	5	5	5	5	5	V
Current Reduction Rate Above 25°C	$\Delta I_F$	0.40	0.42	0.46	0.40	0.40	.040	mA/°C
Ambient Temperature Range		-25° ~ +50°C			-25° ~ +50°C			

**N** No Lamp

## CAP TYPES & COLOR COMBINATIONS

### Full Face Illuminated Cap for Bright LED

#### Lens/Diffuser

Colors Available for Square Cap:

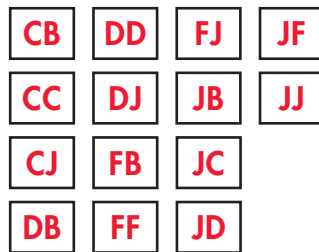

**AT4074**  
Lens

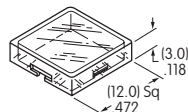

**AT4075**  
Diffuser

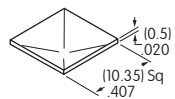

Lens & Diffuser Material: Polycarbonate

#### Lens/Diffuser

Colors Available for Rectangular Cap:

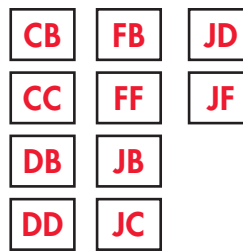

**AT4117**  
Lens

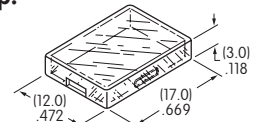

**AT4118**  
Diffuser

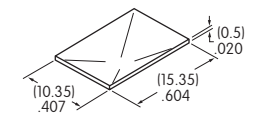

Diffuser Finish: Textured

### Spot Illuminated Caps for Bright & Super Bright LEDs

Cap/Window Colors Available:

**AB** Black Cap with Translucent White Window for LED Display

Material: Polycarbonate

**AT4119** Square for Bright and Super Bright LED

Finish: Matte

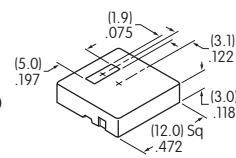

**AT4120** Rectangular for Bright and Super Bright LED

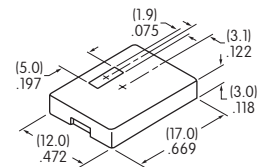

### Full Face Illuminated Caps for Super Bright Bicolor LED

**JB**

**AT4074** Square Lens

**AT4188** Square Diffuser

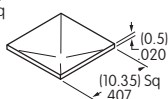
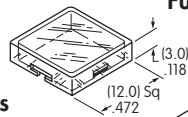

Lens & Diffuser Material: Polycarbonate

**AT4117** Rectangular Lens

**AT4189** Rectangular Diffuser

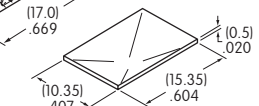
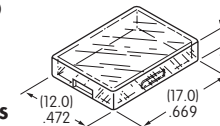

Lens Finish: Glossy

Diffuser Finish: Textured

Cap Colors Available:

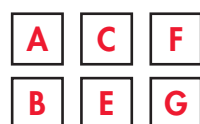

Material: Polycarbonate  
Finish: Glossy

### Opaque Caps for Nonilluminated

**AT4073**  
Square

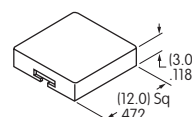

**AT4116**  
Rectangular

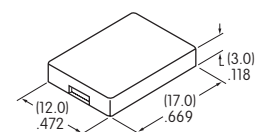

Color Codes: A Black B White C Red D Amber E Yellow F Green G Blue J Clear

Toggles  
 Rockers  
 Pushbuttons  
**D** Illuminated PB  
 Programmable  
 Keylocks  
 Rotaries  
 Slides  
 Tactiles  
 Tilt  
 Touch  
 Indicators  
 Accessories  
 Supplement

### SUPER BRIGHT BICOLOR LEDs FOR ALTERNATING LEGENDS

The electrical specifications shown are determined at a basic temperature of 25°C. LED circuit is isolated and requires external power source. Polarity marks are on bottom of switch. If the source voltage exceeds the rated voltage, a ballast resistor is required. Resistor value can be calculated by using the formula in the Supplement section. LED is an integral part of switch and not available separately.

#### Electrical Specifications for Super Bright Bicolor LEDs

Super Bright LEDs are Electrostatic Sensitive	 ATTENTION ELECTROSTATIC SENSITIVE DEVICES	Color	6CF Red/Green		6DG Amber/Blue		Unit
			Red	Green	Amber	Blue	
Maximum Forward Current	$I_{FM}$		* 30	* 30	* 30	* 30	mA
Typical Forward Current	$I_F$		20	20	20	20	mA
Forward Voltage	$V_F$		2.3	3.2	2.1	3.0	V
Maximum Reverse Voltage	$V_{RM}$		4	4	4	4	V
Current Reduction Rate Above 25°C	$\Delta I_F$		0.33	0.33	0.33	0.33	mA/°C
Ambient Temperature Range			-25° ~ +50°		-25° ~ +50°		°C

\* Value applies to single color illumination for either Red or Green or Amber or Blue. When both colors are illuminated simultaneously, the sum of the currents should not exceed the smallest value of the maximum forward current.

Super Bright Bicolor Red/Green LED with 2 elements

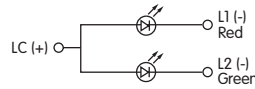

Super Bright Bicolor Amber/Blue LED with 2 elements

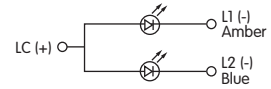

#### Alternating Legend Caps for Super Bright Bicolor LED

**JCF** **JDG**

AT4074 12.0mm Square Flat Cap

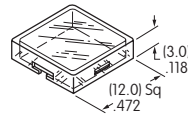

AT9450 Square Legend Insert



AT4188 Square Diffuser



**JCF** **JDG**

AT4117 12.0mm x 17.0mm Rectangular Flat Cap

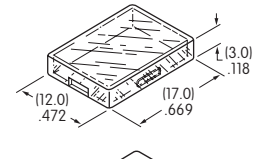

AT9451 Rectangular Legend Insert



AT4189 Rectangular Diffuser

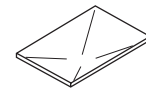

Lens & Diffuser Material: Polycarbonate Legend Insert Material: Polyethylene Terephthalate (PET)

Lens Finish: Glossy Diffuser Finish: Textured

#### Standard Alternating Legend Pairs



Green/Red or Blue/Amber



Green/Red or Blue/Amber



Green/Red or Blue/Amber



Green/Red or Blue/Amber

Cap illumination is alternating Green/Red or Blue/Amber; legend text is black.

Contact factory for other Alternating Legends.

Legend illustrations are approximate representations of the actual characters on the filters.



## TYPICAL SWITCH DIMENSIONS

### Single & Double Pole

### Square • PCB Mount

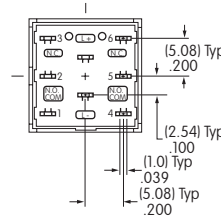
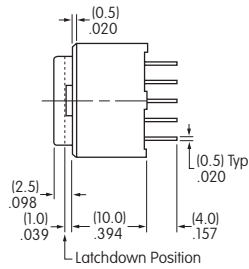
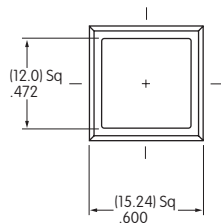

Single pole models do not have terminals 4, 5, & 6.

**UB15SKG035C-CB**

### Single & Double Pole

### Rectangular • PCB Mount

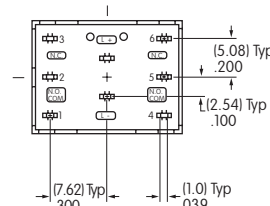
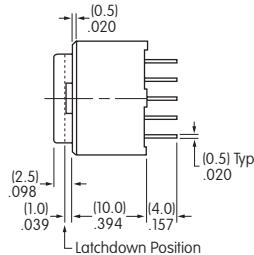
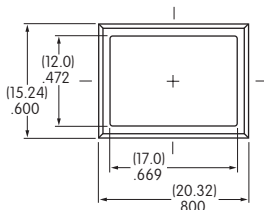

Single pole models do not have terminals 4, 5, & 6.

**UB26RKG035D-DD**

### Single & Double Pole

### Square • Snap-in Mount • Built-in Bezel

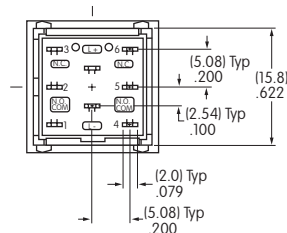
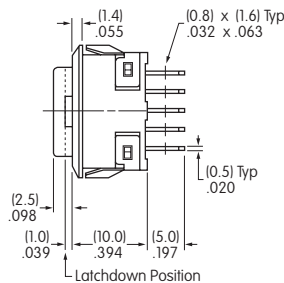
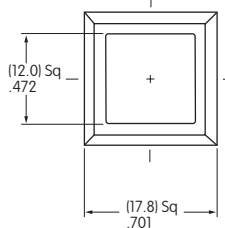

Single pole models do not have terminals 4, 5, & 6.

**UB25KKW015C-CB**

### Single & Double Pole

### Rectangular • Snap-in Mount • Built-in Bezel

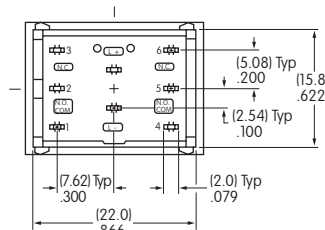
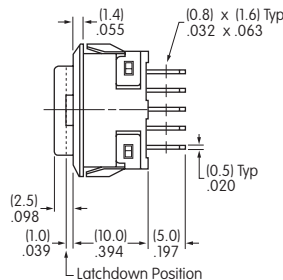
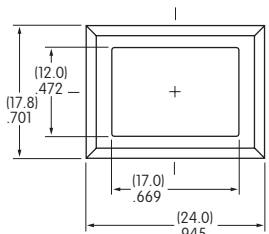

Single pole models do not have terminals 4, 5, & 6.

**UB26NKW015F-FF**

### Single & Double Pole

### Rectangular • Snap-in Mount • Built-in Side Barriers

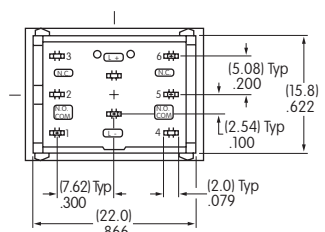
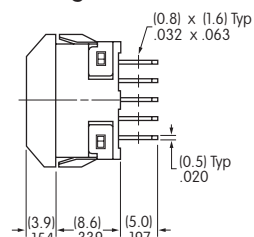
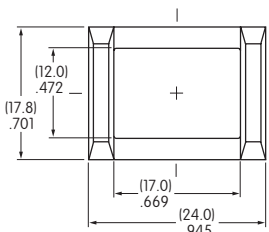

Single pole models do not have terminals 4, 5, & 6.

**UB25NBKW015F-FB**

## TYPICAL SWITCH DIMENSIONS

### Square • PCB Mount

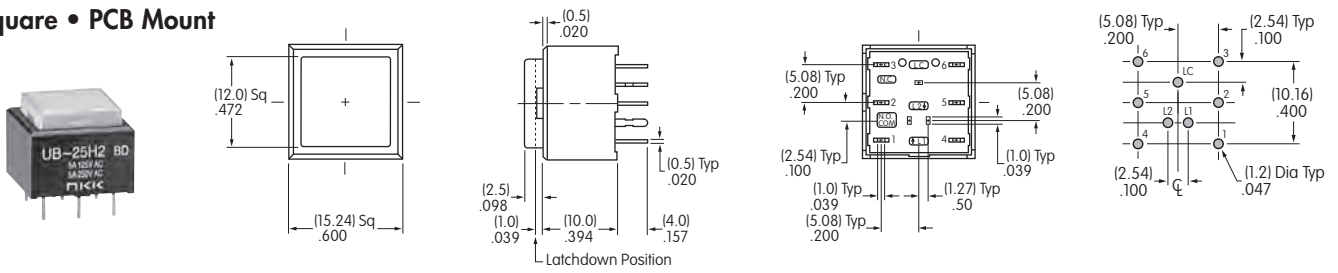

**UB25SKG036DG-JDG11**

Single pole models do not have terminals 4, 5, & 6.

### Square • Snap-in Mount • Built-in Bezel

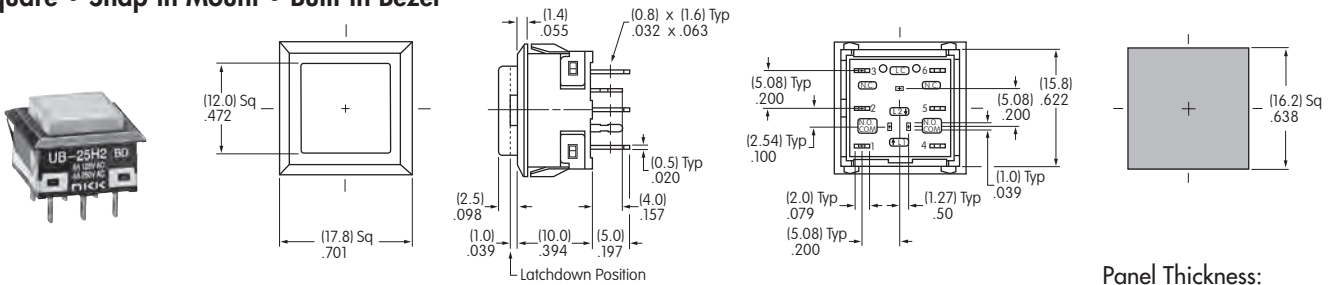

**UB25KKW016DG-JDG11**

Single pole models do not have terminals 4, 5, & 6.

Panel Thickness:  
(1.0 ~ 3.2mm) .039 ~ .126"

### Rectangular • PCB Mount

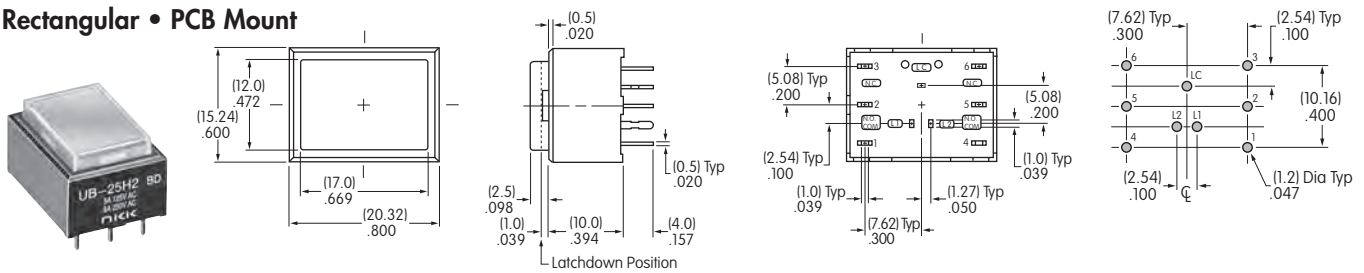

**UB25RKG036DG-JDG11**

Single pole models do not have terminals 4, 5, & 6.

### Rectangular • Snap-in Mount • Built-in Bezel

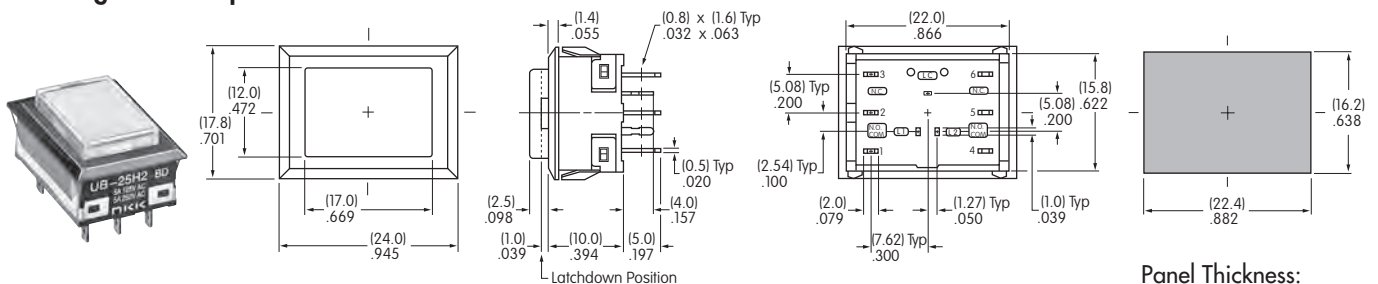

**UB26NKW016DG-JDG11**

Single pole models do not have terminals 4, 5, & 6.

Panel Thickness:  
(1.0 ~ 3.2mm) .039 ~ .126"

### Rectangular • Snap-in Mount • Built-in Side Barriers

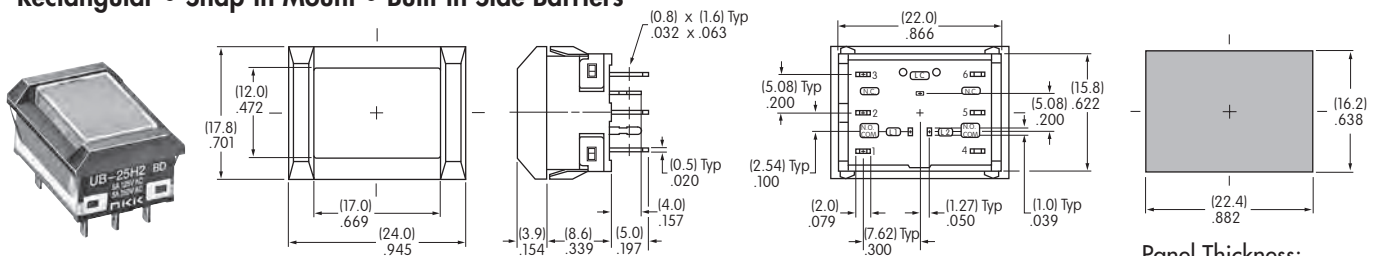

**UB26NBKW016DG-JDG11**

Single pole models do not have terminals 4, 5, & 6.

Panel Thickness:  
(1.0 ~ 3.2mm) .039 ~ .126"

## OPTIONAL ACCESSORIES

### Spring Loaded Protective Guard for Snap-in Mounting of Square PCB Model

#### AT4173 Square Protective Guard/ Snap-in Frame

Opens 180°  
Closes automatically

**Materials:**  
Cover: Clear Polycarbonate  
Base: Black Polyamide  
Coil Spring: Stainless Steel

**Recommended Panel Thickness:**  
.039" ~ .126"  
(1.0mm ~ 3.2mm)

**Recommended Panel-to-PCB Range:**  
.354" ~ .433"  
(9.0mm ~ 11.0mm)

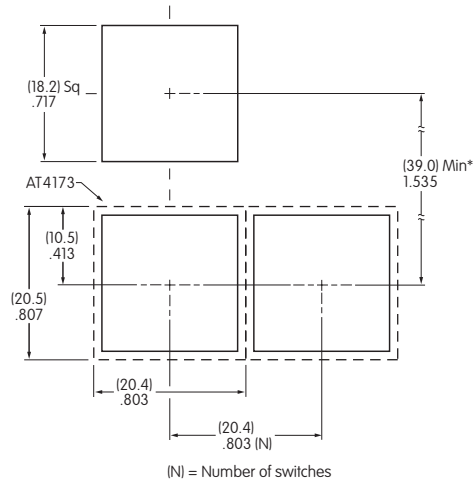
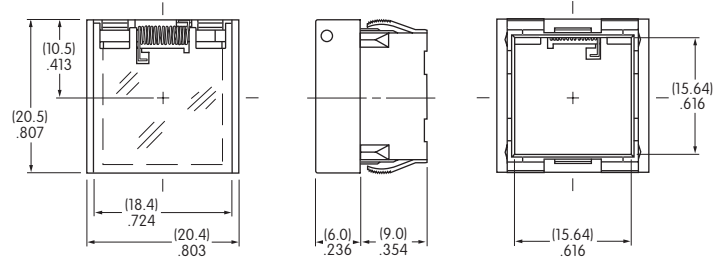
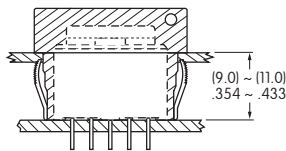

\* Minimum dimension allows opening of cover to 180°

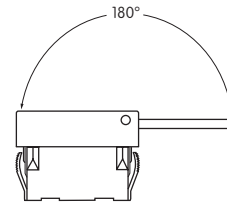

#### Installation

- ① Install switch onto PC board.
- ② Snap protective guard into panel.
- ③ Join the two assemblies.

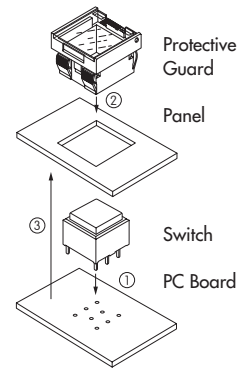

### Spring Loaded Protective Guard for Square Snap-in Model

#### AT4171 Square Protective Guard

Opens 180°  
Closes automatically

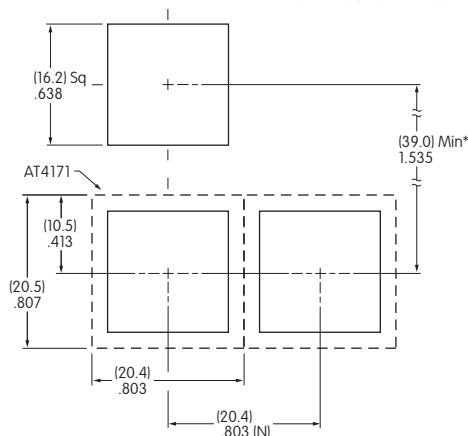
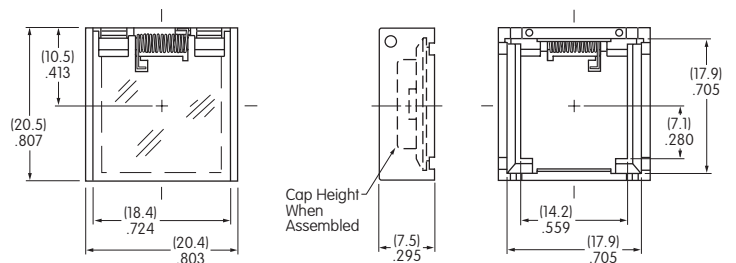
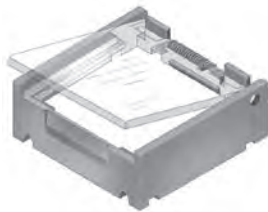

(N) = Number of switches \* Minimum dimension allows opening of cover to 180°

**Materials:**  
Cover: Clear Polycarbonate  
Base: Black GFR Polyamide  
Coil Spring: Stainless Steel

**Recommended Panel Thickness:**  
.039" ~ .106" (1.0mm ~ 2.7mm)

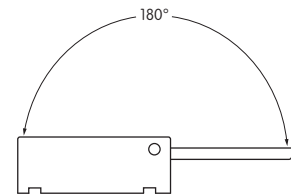

## OPTIONAL ACCESSORIES

### Spring Loaded Protective Guard for Snap-in Mounting of Rectangular PCB Model

#### AT4174 Rectangular Protective Guard/ Snap-in Frame

Opens 180°  
Closes automatically

#### Materials:

Cover: Clear Polycarbonate  
Base: Black Polyamide  
Coil Spring: Stainless Steel

**Recommended  
Panel Thickness:**  
.039" ~ .126"  
(1.0mm ~ 3.2mm)

**Recommended  
Panel-to-PCB Range:**  
.354" ~ .433"  
(9.0mm ~ 11.0mm)

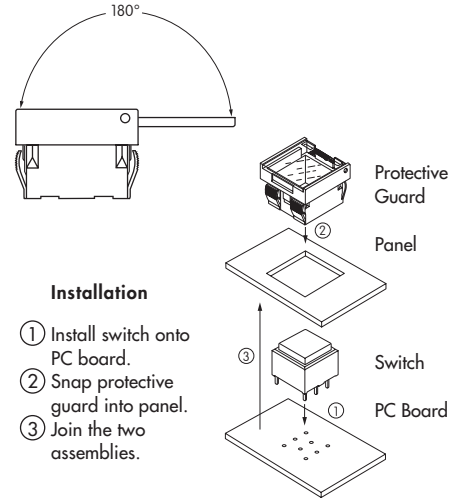
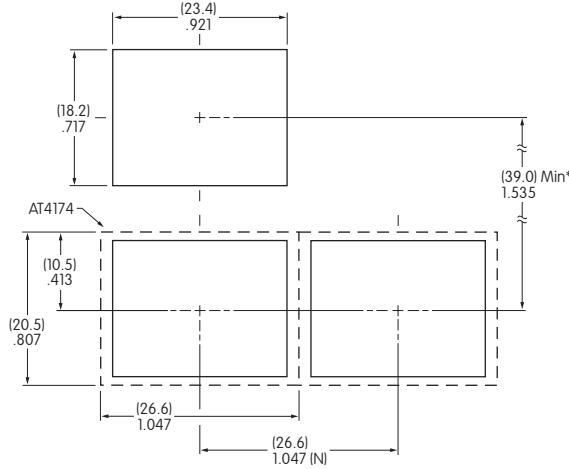
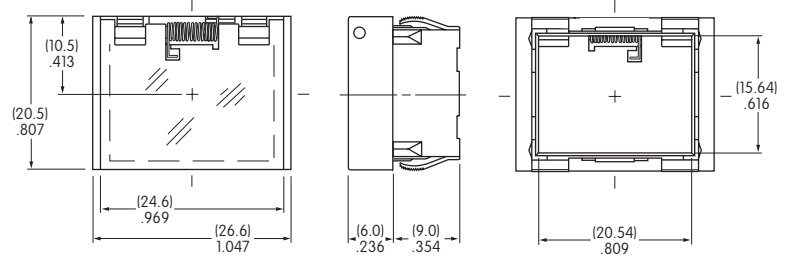
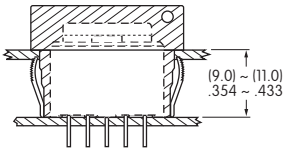

#### Installation

- ① Install switch onto PC board.
- ② Snap protective guard into panel.
- ③ Join the two assemblies.

(N) = Number of switches \* Minimum dimension allows opening of cover to 180°

### Spring Loaded Protective Guard for Rectangular Snap-in Model

#### AT4172 Rectangular Protective Guard

Opens 180°  
Closes automatically

#### Materials:

Cover: Clear Polycarbonate  
Base: Black GFR Polyamide  
Coil Spring: Stainless Steel

**Recommended Panel Thickness:**  
.039" ~ .106" (1.0mm ~ 2.7mm)

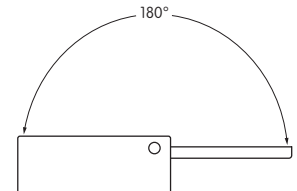
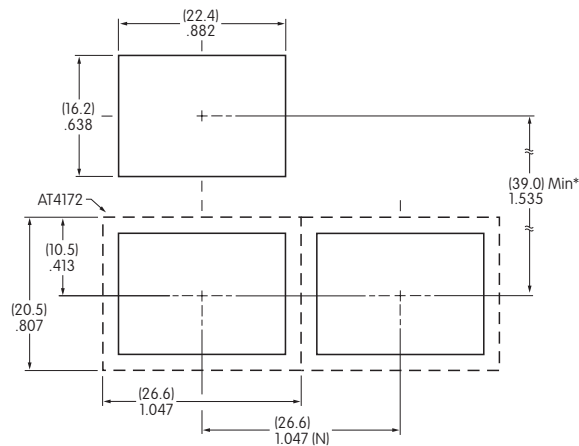
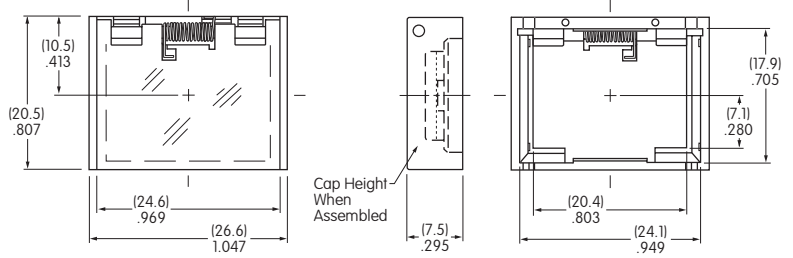
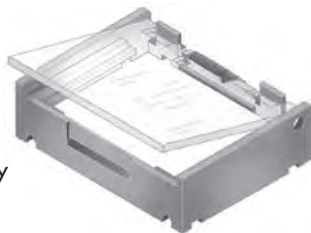

(N) = Number of switches \* Minimum dimension allows opening of cover to 180°

OPTIONAL ACCESSORIES

AT4001  
Square

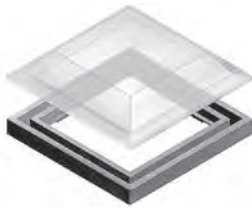

Only for use with KK mounting type

AT4011  
Rectangular

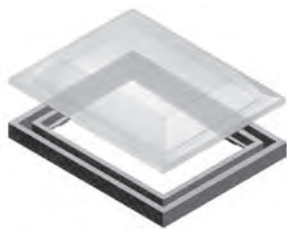

Only for use with NK mounting type

Dust Covers

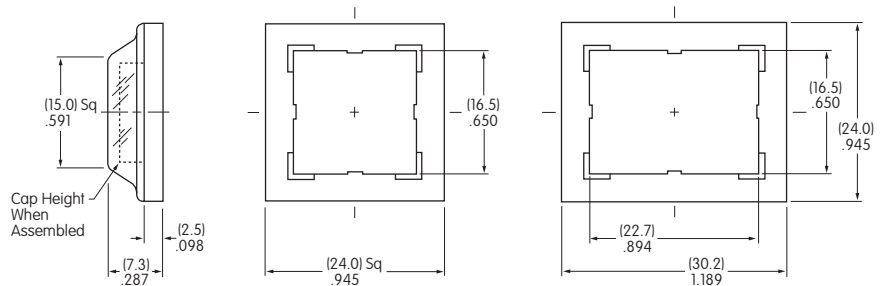

Materials:

PVC with polyethylene gasket  
(PVC loses pliability below 0°C (32°F).)

Recommended Panel Thickness: .039" ~ .098" (1.0mm ~ 2.5mm)

LEGENDS

NKK Switches can provide custom legends for caps. Contact factory for more information.

Suggested Printable Area for UB Lens & Film Insert

Recommended Methods: Laser Etch on clear lens, Screen Print or Pad Print on lens;  
Laser Print on film insert.

Square Cap



Rectangular Cap

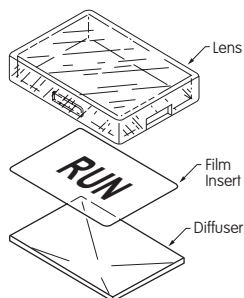

Shaded areas are printable areas.

Lens

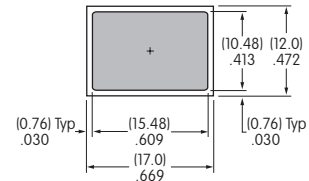
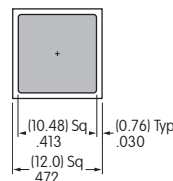

Film Insert

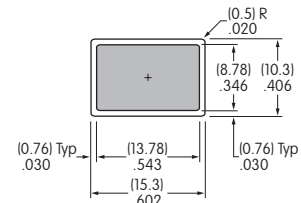
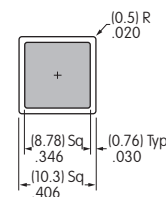

Film Insert: Clear Polyester 0.15mm max. thickness

# General Specifications

## Electrical Capacity (Resistive Load)

**Power Level (silver):** 5A @ 125/250V AC or 5A @ 30V DC  
**Logic Level (gold):** 0.4VA maximum @ 28V AC/DC maximum  
 (Applicable Range 0.1mA ~ 0.1A @ 20mV ~ 28V)  
 Note: Find additional explanation of operating range in Supplement section.

## Other Ratings

**Contact Resistance:** 50 milliohms maximum for silver; 100 milliohms maximum for gold  
**Insulation Resistance:** 200 megohms minimum @ 500V DC  
**Dielectric Strength:** 1,000V AC minimum between contacts for 1 minute minimum;  
 1,500V AC minimum between contacts & case for 1 minute minimum  
**Mechanical Life:** 1,000,000 operations minimum for momentary;  
 200,000 operations minimum for alternate action  
**Electrical Life:** 10,000 operations minimum for silver;  
 200,000 operations minimum for gold  
**Nominal Operating Force:** Single Pole: 1.90N  
 Double Pole: 2.55N  
**Contact Timing:** Break before make  
**Travel:** Pretravel .067" (1.7mm); Overtravel .024" (0.6mm); Total Travel .091" (2.3mm)

## Materials & Finishes

**Housing/Bezel:** Glass fiber reinforced polyamide (UL94V-0)  
**Snap-in Frame:** Stainless steel  
**Movable Contactor:** Phosphor bronze  
**Movable Contacts:** Silver alloy or copper with gold plating  
**Stationary Contacts:** Silver alloy or copper with gold plating  
**Switch Terminals:** Phosphor bronze with silver or gold plating  
**Lamp Terminals:** Brass with tin plating  
**Base:** Glass fiber reinforced liquid crystal polymer (UL94V-0)

## Environmental Data

**Operating Temperature Range:** -25°C through +50°C (-13°F through +122°F) for Illuminated  
 -25°C through +70°C (-13°F through +158°F) for Nonilluminated  
**Humidity:** 90 ~ 95% humidity for 240 hours @ 40°C (104°F)  
**Vibration:** 10 ~ 55Hz with peak-to-peak amplitude of 1.5mm traversing the frequency range & returning in 1 minute; 3 right angled directions for 2 hours  
**Shock:** 50G (490m/s<sup>2</sup>) acceleration (tested in 6 right angled directions, with 5 shocks in each direction)

## Installation

**Cap Installation Force:** 15.0N maximum downward force on cap

## Processing

**Soldering:** Wave Soldering (PC version): See Profile A in Supplement section.  
 Manual Soldering: See Profile A in Supplement section.  
**Cleaning:** These devices are not process sealed. Hand clean locally using alcohol based solution.

## Standards & Certifications

**Flammability Standards:** UL94V-0 housing/bezel & base  
**UL:** **File No. E44145 - Recognized only when ordered with marking on switch.**  
 Add "/U" or "/CUL" before dash in part number to order UL recognized switch.  
 UL recognized only when ordered switch body with cap assembled.  
 All single & double pole models recognized at 5A @ 125/250V AC or 0.014A @ 28V DC.

# Distinctive Characteristics

Wide selection of illumination effects is achieved with single and bicolor, 1- or 6-element LEDs in flat, beveled, or sculptured caps.

Alternating legends in choice of sculptured or flat caps, combined with super bright bicolor LED.

Combination of PCB mountability and short body allows use in compact applications.

Small behind panel dimension for snap-in mounting in tight spaces.

Snap-acting contact mechanism provides sensitive actuation with audible feedback; quick-make, quick-break characteristic limits arcing and prolongs electrical life.

Latchdown mechanism, independent of switching mechanism, gives outstanding stability and reliability plus visible and tactile indication of circuit status.

Terminals are epoxy sealed to lock out flux, solvents, and other contaminants.

Momentary and alternate action circuits available in the same space-saving body size.

Matching indicators available.

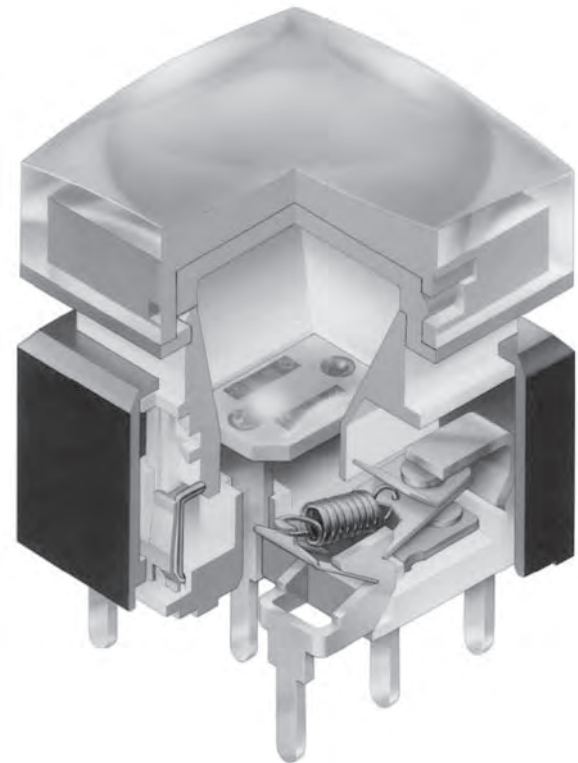

Actual Size

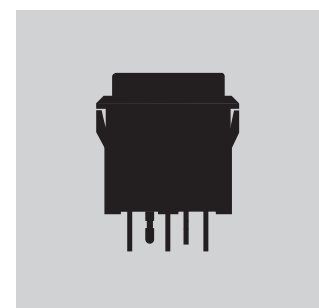

- Toggle
- Rockers
- Pushbuttons
- D Illuminated PB**
- Programmable
- Key locks
- Rotaries
- Slides
- Tactiles
- Tilt
- Touch
- Indicators
- Accessories
- Supplement

### TYPICAL SWITCH

UB2

1

5

SK

G

03

#### Poles

1	SPDT
2	DPDT

#### Circuits

5	ON	(ON)
( ) = Momentary		
6	ON	ON
Alternate Action with Latchdown		

#### Mounting Types

##### PCB Mounting

SK	Square
* Snap-in Mounting	
KK	Square
* Standard with Solder Lug terminals	

#### Terminals

01	Solder Lug (for Snap-in Mounting)
03	Straight PC

#### Contacts & Ratings

W	Silver Rated 5A @ 125/250V AC
G	Gold Rated 0.4VA max @ 28V AC/DC max

#### Part Numbers for Alternating Legends

Color	15mm Square Sculptured Cap	15mm Square Flat Cap
	Part Number	Part Number
Red/Green	AT3069JCF11 ~ AT3069JCF14	AT3070JCF11 ~ AT3070JCF14
Amber/Blue	AT3069JDG11 ~ AT3069JDG14	AT3070JDG11 ~ AT3070JDG14

Refer to Ordering Table for Alternating Legend that corresponds with last 2 digits of part number.

#### IMPORTANT:



Switches are supplied without UL & cULus marking unless specified. **UL & cULus recognized only when ordered with marking on switch.** Specific models, ratings, & ordering instructions are noted on the General Specifications page.

#### DESCRIPTION FOR TYPICAL ORDERING EXAMPLE

**UB215SKG035C-1JC**





ORDERING EXAMPLE

5C

1JC

**LEDS**

Bright LED	
5C	Red
5D	Amber
5F	Green

Super Bright LED	
6B	White
6F	Green
6G	Blue

Super Bright Bicolor LED	
6CF	Red/Green
6DG	Amber/Blue

Nonilluminated	
N	Nonilluminated

**Cap Types & Colors**

Sculptured Cap Lens/Diffuser Colors	
1JB	Clear/White
1JC	Clear/Red
1JD	Clear/Amber
1JF	Clear/Green

Beveled Cap & Colors	
2B	White
2C	Red
2D	Amber
2F	Green

Flat Cap Lens/Diffuser Colors	
3JB	Clear/White
3JC	Clear/Red
3JD	Clear/Amber
3JF	Clear/Green

Sculptured Cap Lens/Diffuser Color	
1JB	Clear/White

Beveled Cap & Color	
2B	White

Flat Cap Lens/Diffuser Color	
3JB	Clear/White

Sculptured Cap Lens/Diffuser Color	
1JB	Clear/White

Beveled Cap & Color	
2B	White

Flat Cap Lens/Diffuser Color	
3JB	Clear/White

Sculptured Cap with Alternating Legend	
4JCF	Clear; Red/Green
4JDG	Clear; Amber/Blue

Flat Cap with Alternating Legend	
5JCF	Clear; Red/Green
5JDG	Clear; Amber/Blue

Sculptured Cap Lens/Insert Colors			
4JA	Clear/Black	4JD	Clear/Amber
4JB	Clear/White	4JF	Clear/Green
4JC	Clear/Red		

Beveled Cap & Colors			
5A	Black	5D	Amber
5B	White	5F	Green
5C	Red		

**Alternating Legends**



11	ON (pos)	OFF (pos)
12	ON (neg)	OFF (neg)
13	START	STOP
14	OPEN	CLOSE

See Part Numbers Table on Previous Page.

Contact factory for custom options.

- Toggle
- Rockers
- Pushbuttons
- D** Illuminated PB
- Programmable
- Key locks
- Rotaries
- Slides
- Tactiles
- Tilt
- Touch
- Indicators
- Accessories
- Supplement

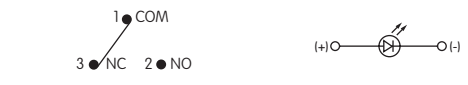
## POLES & CIRCUITS

Pole	Model	Plunger Position ( ) = Momentary		Connected Terminals		Throw & Switch/Lamp Schematics
		Normal	Down	Normal	Down	
SP	UB215 *UB216	ON ON	(ON) ON	1-3	1-2	Notes: Switch is marked with NC, NO, COM, L+ & L-. Lamp circuit is isolated and requires an external power source. 
DP	UB225 *UB226	ON ON	(ON) ON	1-3 4-6	1-2 4-5	

\* When in latched position for the alternate circuit, cap positions above the housing are:  
.059" (1.5mm) for snap-in models & .276" (7.0mm) for PCB models.

## MOUNTING TYPES & SHAPES

### PCB Mounting

**SK**

Square

SP, Single Color LED

DP, Single Color LED

SP, Bicolor LED

DP, Bicolor LED

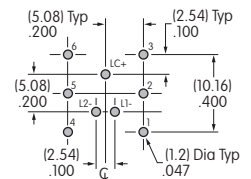
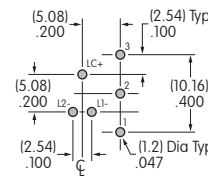
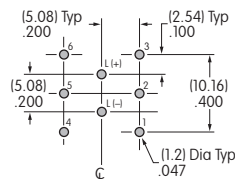
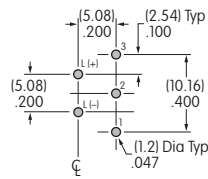
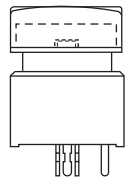

### Snap-in Mounting (Solder Lug)

**KK**

Square with Built-in Bezel

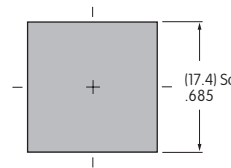
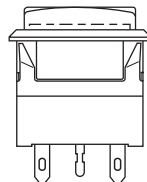

Panel Thickness:  
.039 ~ .126"  
(1.0 ~ 3.2mm)

## CONTACT MATERIALS & RATINGS

**W**

Silver Contacts

Power Level

5A @ 125V AC & 250V AC

**G**

Gold Contacts

Logic Level

0.4VA maximum @ 28V AC/DC maximum

Complete explanation of operating range in Supplement section.

## SWITCH & LAMP TERMINALS

**01**

Solder Lug

For Switch & Bright LED

For Super Bright & Bicolor LED

**03**

Straight PC

For Switch & Bright LED

For Super Bright & Bicolor LED

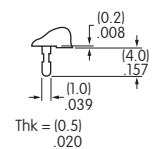
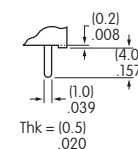
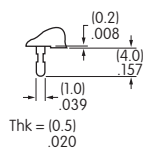
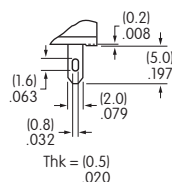

**BRIGHT LED & CAPS**

The electrical specifications shown are determined at a basic temperature of 25°C. LED circuit is isolated and requires an external power source. Polarity marks are on the bottom of the switch. If the source voltage exceeds the rated voltage, a ballast resistor is required. The resistor value can be calculated by using the formula in the Supplement section.

The LED is an integral part of the switch and not available separately.

**Electrical Specifications for Bright LED**

		<b>5C</b>	<b>5D</b>	<b>5F</b>	
	Color	Red	Amber	Green	Unit
Maximum Forward Current	$I_{FM}$	30	30	25	mA
Typical Forward Current	$I_F$	20	20	20	mA
Forward Voltage	$V_F$	1.85	2.0	2.1	V
Maximum Reverse Voltage	$V_{RM}$	5	5	5	V
Current Reduction Rate Above 25°C	$\Delta I_F$	0.40	0.42	0.46	mA/°C
Ambient Temperature Range		-25° ~ +50°			°C

Bright Single Color LED with 1 element



**Caps for Bright LED**

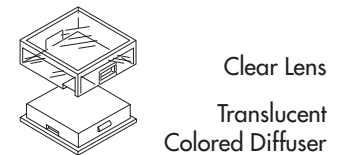
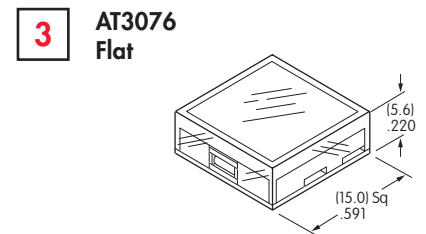
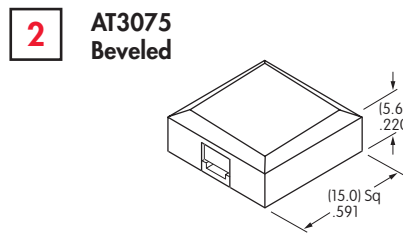
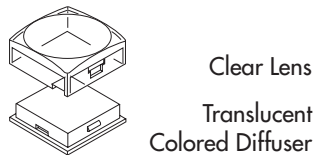
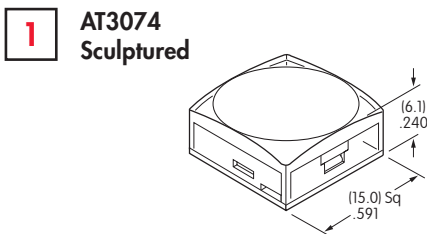

**Lens/Diffuser Colors Available:**

- JB** Clear/White
- JC** Clear/Red
- JD** Clear/Amber
- JF** Clear/Green

**Cap Colors Available:**

- B** White
- C** Red
- D** Amber
- F** Green

**Lens/Diffuser Colors Available:**

- JB** Clear/White
- JC** Clear/Red
- JD** Clear/Amber
- JF** Clear/Green

Material: Polycarbonate Finish: Glossy

### SUPER BRIGHT LEDS & CAPS

The electrical specifications shown are determined at a basic temperature of 25°C. LED circuit is isolated and requires an external power source. Polarity marks are on the bottom of the switch. If the source voltage exceeds the rated voltage, a ballast resistor is required. The resistor value can be calculated by using the formula in the Supplement section. The LED is an integral part of the switch and not available separately.

#### Electrical Specifications for Super Bright LEDs

Super Bright LEDs are Electrostatic Sensitive		Color	<b>6B</b> White	<b>6F</b> Green	<b>6G</b> Blue	Unit
Maximum Forward Current		$I_{FM}$	20	30	30	mA
Typical Forward Current		$I_F$	15	20	20	mA
Forward Voltage		$V_F$	3.3	3.5	3.6	V
Maximum Reverse Voltage		$V_{RM}$	5	5	5	V
Current Reduction Rate Above 25°C		$\Delta I_F$	0.25	0.50	0.50	mA/°C
Ambient Temperature Range			-20° ~ +50°			°C

Super Bright Single Color LED with 1 element



#### Caps for Super Bright LED

**1JB**

**AT3074JB**  
Sculptured  
Clear Lens/  
White Diffuser

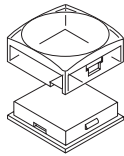
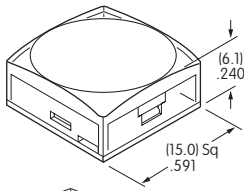

Clear Lens  
Translucent  
White Diffuser

**2B**

**AT3075B**  
Beveled  
White Cap

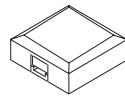
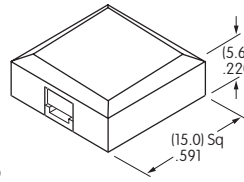

Translucent  
White Cap

**3JB**

**AT3076JB**  
Flat  
Clear Lens/  
White Diffuser

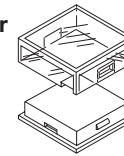
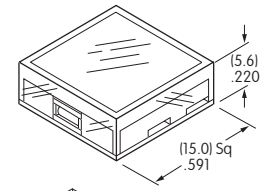

Clear Lens  
Translucent  
White Diffuser

Material: Polycarbonate      Finish: Glossy

### SUPER BRIGHT BICOLOR LEDS & CAPS

The electrical specifications shown are determined at a basic temperature of 25°C. LED circuit is isolated and requires an external power source. Polarity marks are on the bottom of the switch. If the source voltage exceeds the rated voltage, a ballast resistor is required. The resistor value can be calculated by using the formula in the Supplement section. The LED is an integral part of the switch and not available separately.

#### Electrical Specifications for Super Bright Bicolor LEDs

Super Bright LEDs are Electrostatic Sensitive		Color	<b>6CF</b> Red      Green		<b>6DG</b> Amber      Blue		Unit	
Maximum Forward Current		$I_{FM}$	30 * 25 for Amber	25 * 22 for Amber	30	30	mA	
Typical Forward Current		$I_F$	20	20	15	15	mA	
Forward Voltage		$V_F$	2.1	3.5	2.0	2.8	V	
Maximum Reverse Voltage		$V_{RM}$	4	4	4	4	V	
Current Reduction Rate Above 25°C		$\Delta I_F$	0.40	0.33	0.33	0.33	mA/°C	
Ambient Temperature Range			-20° ~ +50°			-20° ~ +50°		°C

Super Bright Bicolor LED with 2 elements

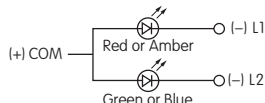

\* Amber color is achieved by lighting red and green simultaneously, but is not suitable for Alternating Legends.

Caps for Super Bright Bicolor LED

**1JB** AT3074JB Sculptured Clear Lens/White Diffuser

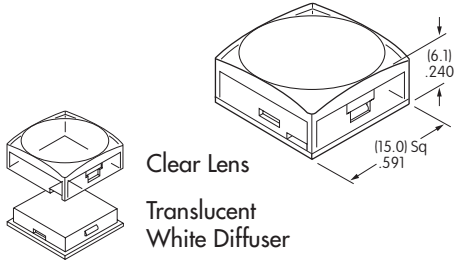

**2B** AT3075B Beveled White Cap

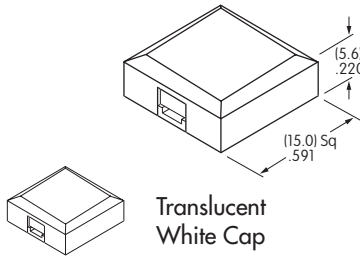

**3JB** AT3076JB Flat Clear Lens/White Diffuser

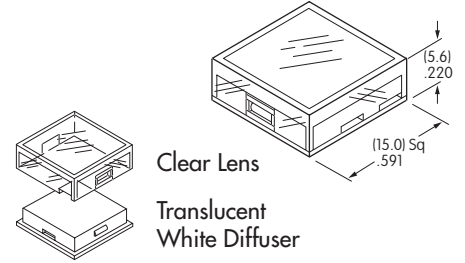

Material: Polycarbonate Finish: Glossy

Alternating Legend Caps for Super Bright Bicolor LED

AT3069J Sculptured Cap with Alternating Legend

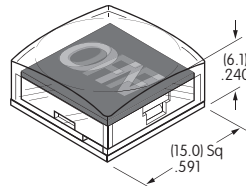

AT3070J Flat Cap with Alternating Legend

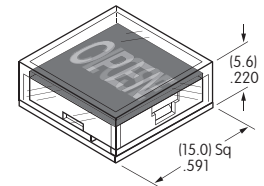

**4JCF** Red/Green

**5JCF** Red/Green

**4JDG** Amber/Blue

**5JDG** Amber/Blue

Clear Lens Alternating Legend Filter

Clear Lens Alternating Legend Filter

Material: Polycarbonate Finish: Glossy

Standard Alternating Legend Pairs



Green/Red or Blue/Amber



Green/Red or Blue/Amber



Green/Red or Blue/Amber

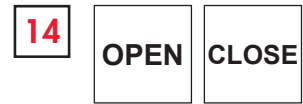

Green/Red or Blue/Amber

Cap illumination is alternating Green/Red or Blue/Amber; legend text is black.  
Contact factory for other Alternating Legends.  
Legend illustrations are approximate representations of the actual characters on the filters.

**No Code** No Lamp

CAP TYPES & COLOR COMBINATIONS FOR NONILLUMINATED

**4** AT3073 Sculptured

Lens/Insert Colors Available:

**JA** Clear/Black

**JB** Clear/White

**JC** Clear/Red

**JD** Clear/Amber

**JF** Clear/Green

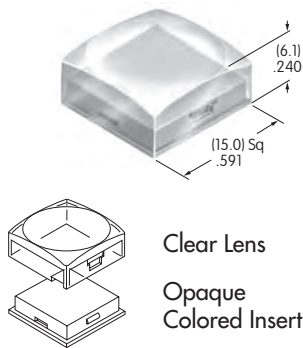

Material: Polycarbonate Finish: Glossy

**5** AT3077 Beveled

Cap Colors Available:

**A** Black

**B** White

**C** Red

**D** Amber

**F** Green

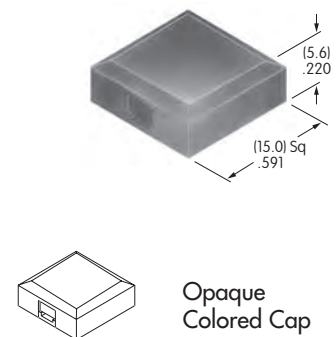

Material: Polycarbonate Finish: Glossy

## TYPICAL SWITCH DIMENSIONS

### Bright & Super Bright LED Straight PC

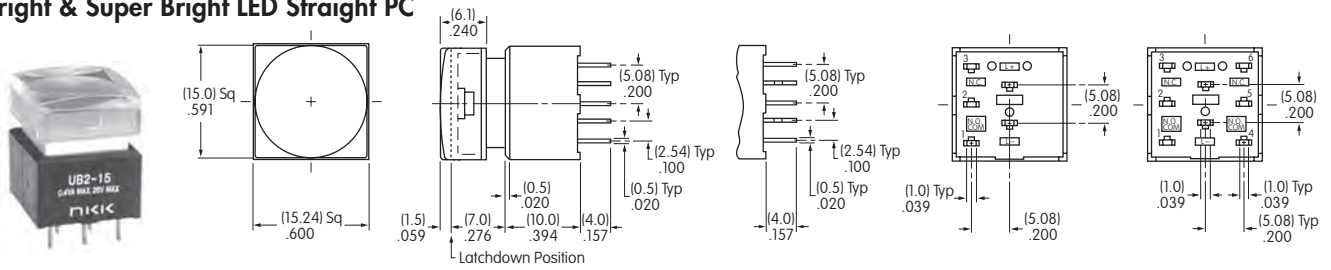

**UB215SKG035C-1JC**

Bright Single Color LED

Super Bright Single Color LED

Single Pole

Double Pole

### Bicolor LED Straight PC

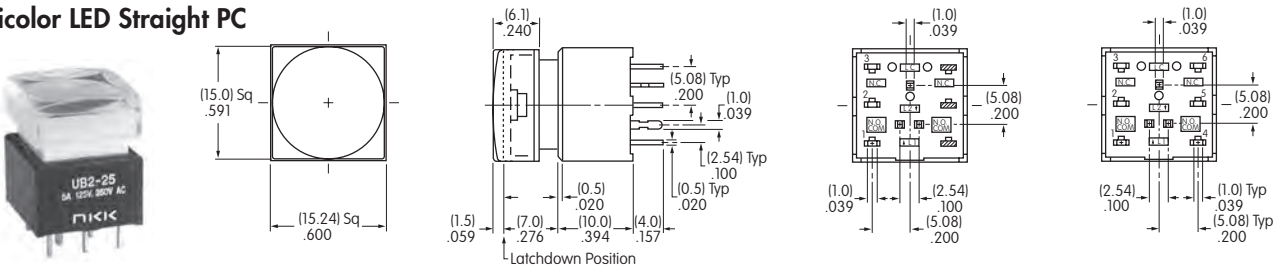

**UB225SKG03CF-1JB**

Bicolor LED Side View

Single Pole

Double Pole

### Bright LED Solder Lug

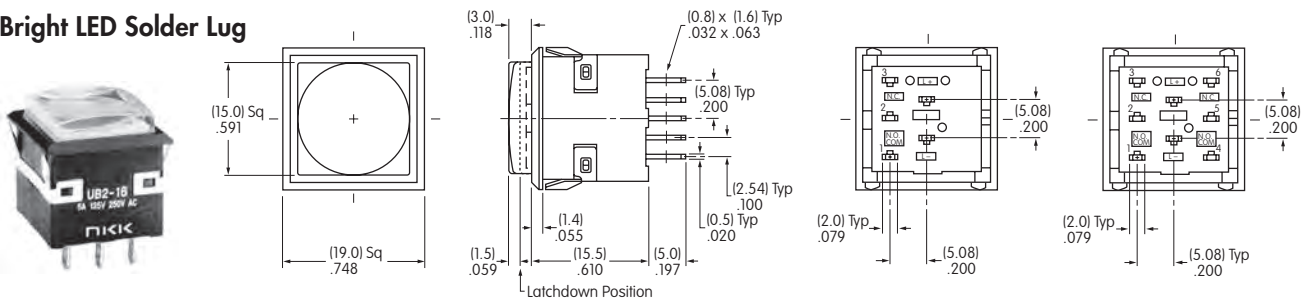

**UB216KKW015F-1JF**

Single Color LED Side View

Single Pole

Double Pole

### Super Bright LED Solder Lug

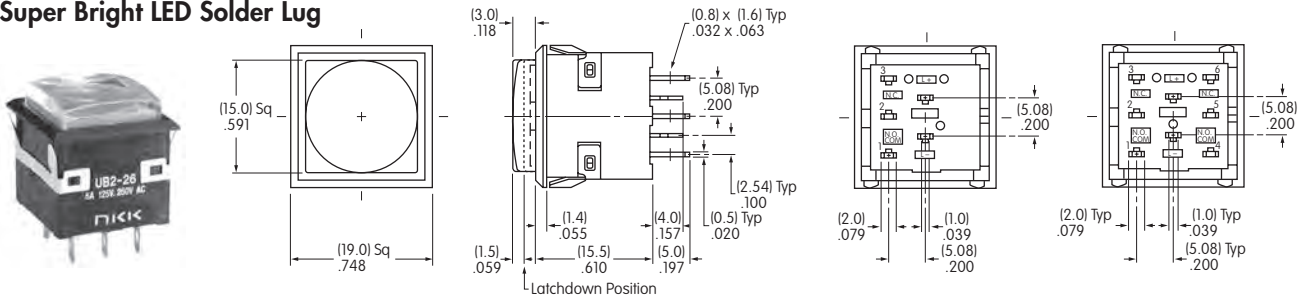

**UB226KKW016F-1JF**

Single Color LED Side View

Single Pole

Double Pole

### Bicolor LED Solder Lug

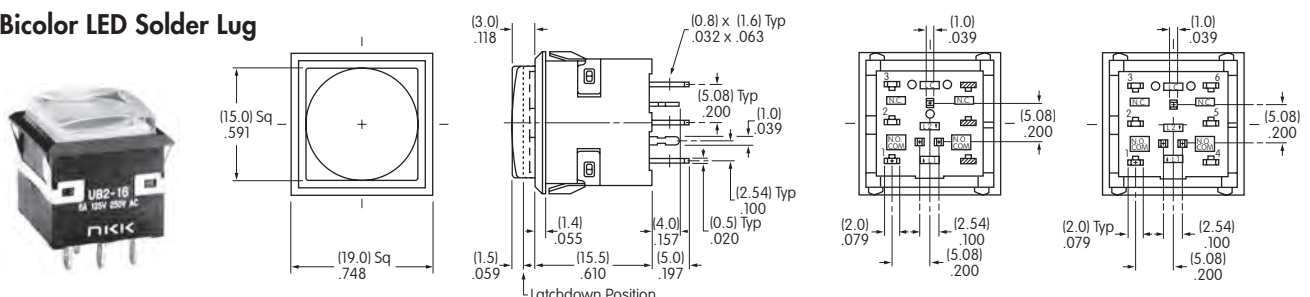

**UB216KKW01CF-1JB**

Bicolor LED Side View

Single Pole

Double Pole

Toggles  
Rockers  
Pushbuttons  
Illuminated PB  
D  
Programmable  
Keylocks  
Rotaries  
Slides  
Tactiles  
Tilt  
Touch  
Indicators  
Accessories  
Supplement

## OPTIONAL ACCESSORIES

### Protective Guard for Snap-in Model

#### AT4141

Opens 90°  
Closes manually



#### Materials:

Cover: Clear Polycarbonate  
Base: Black GFR Polyamide

#### Recommended Panel Thickness:

.039" ~ .106" (1.0mm ~ 2.7mm)

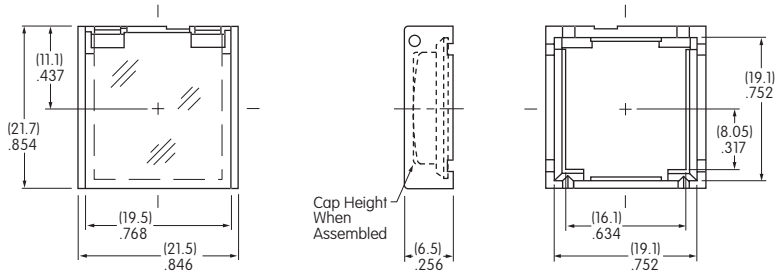

### Spring Loaded Protective Guard for Snap-in Mounting of PCB Model

#### AT4170

Opens 180°  
Closes automatically



#### Materials:

Cover: Clear Polycarbonate  
Base: Black Polyamide  
Coil Spring: Stainless Steel

#### Recommended Panel Thickness:

.039" ~ .126"  
(1.0mm ~ 3.2mm)

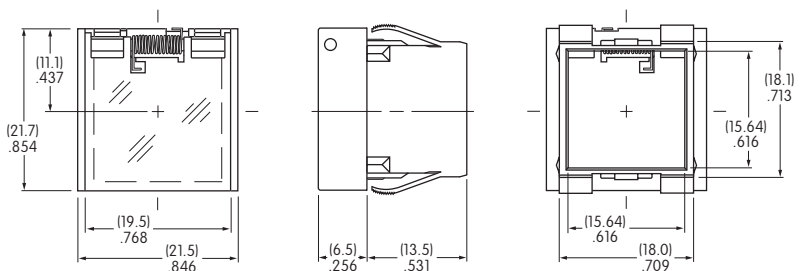

#### Recommended Panel-to-PCB Range:

.531" (13.5mm)

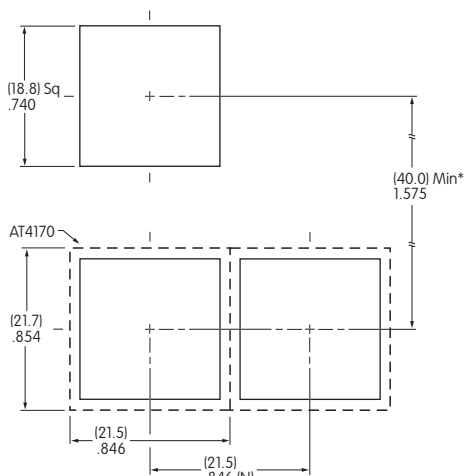
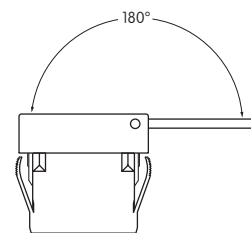
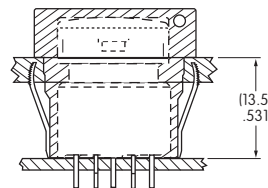

(N) = Number of switches

\* Minimum dimension allows opening of cover to 180°

#### Installation

- ① Install switch onto PC board.
- ② Snap protective guard into panel.
- ③ Join the two assemblies.

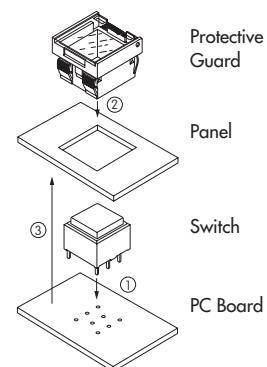

## OPTIONAL ACCESSORIES

### Spring Loaded Protective Guard for Snap-in Model

#### AT4142

Opens 180°  
Closes automatically



#### Materials:

Cover: Clear Polycarbonate  
Base: Black GFR Polyamide  
Coil Spring: Stainless Steel

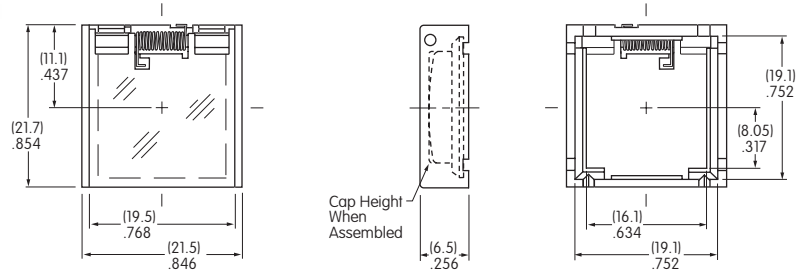

#### Recommended Panel Thickness:

.039" ~ .106" (1.0mm ~ 2.7mm)

### Dust Cover

AT4145 Not for use with barriers.

#### Materials:

Lid: Clear PVC  
Operating temperature range:  
0°C ~ +70°C (32°F ~ 158°C).  
Gasket: Polyethylene

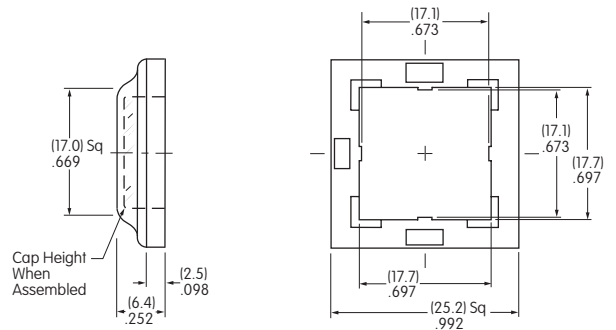
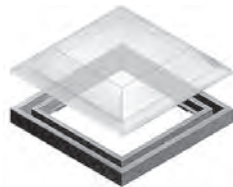

#### Recommended Panel Thickness

.039" ~ .098" (1.0mm ~ 2.5mm)

### Barriers for Snap-in Mount

#### AT4143 End

#### AT4144 Center

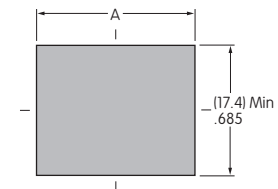
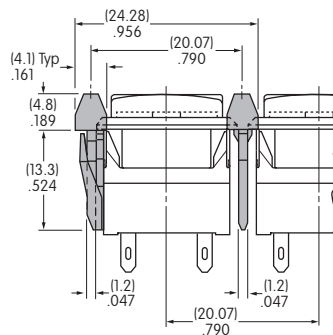
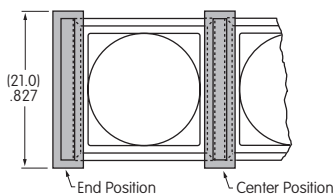

Cutouts for more than 1 Switch:

$$A = .799" (20.3\text{mm}) \times \text{Number of Switches} + .063" (1.6\text{mm})$$

Material: Polyamide



LEGENDS

NKK Switches can provide custom legends for caps. Contact factory for more information.

Suggested Printable Area for UB2 Lens, Film Insert or Diffuser

Recommended Methods: Laser Etch on clear lens, Screen Print or Pad Print on lens;  
Laser Print on film insert.

Shaded areas are printable areas.

Beveled Cap

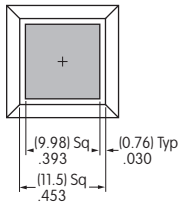
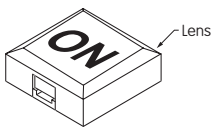

Flat Cap

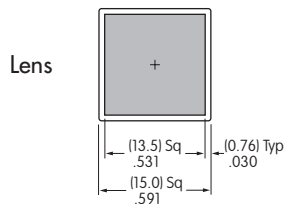

Film Insert or Diffuser

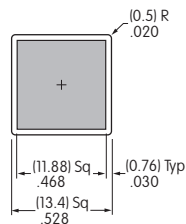

Sculptured Cap

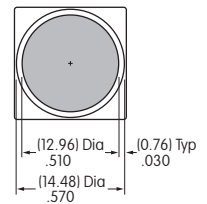

Film Insert or Diffuser

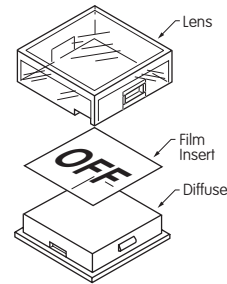
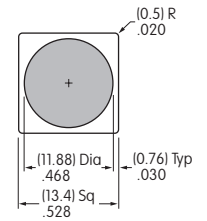

Film Insert: Clear Polyester 4 mil maximum thickness

Toggles

Rockers

Pushbuttons

**D** Illuminated PB

Programmable

Key locks

Rotaries

Slides

Tactiles

Tilt

Touch

Indicators

Accessories

Supplement

# General Specifications

## Electrical Capacity (Resistive Load)

<b>Power Level (silver):</b>	3A @ 125V AC or 3A @ 250V AC or 3A @ 30V DC
<b>Logic Level (gold):</b>	0.4VA maximum @ 28V AC/DC maximum (Applicable Range 0.1mA ~ 0.1A @ 20mV ~ 28V) Note: Find additional explanation of operating range in Supplement section.

## Other Ratings

<b>Contact Resistance:</b>	50 milliohms maximum for silver; 100 milliohms maximum for gold
<b>Insulation Resistance:</b>	200 megohms minimum @ 500V DC
<b>Dielectric Strength:</b>	1,000V AC minimum between contacts for 1 minute minimum; 1,500V AC minimum between contacts & case for 1 minute minimum
<b>Mechanical Life:</b>	1,000,000 operations minimum for momentary circuit 200,000 operations minimum for maintained circuit
<b>Electrical Life:</b>	100,000 operations minimum
<b>Nominal Operating Force:</b>	Single pole: 1.47N for nonsealed; 1.67N for sealed Double pole: 2.75N for nonsealed; 2.94N for sealed
<b>Contact Timing:</b>	Nonshorting (break-before-make)
<b>Travel:</b>	Pretravel .059" (1.5mm); Overtravel .059" (1.5mm); Total Travel .118" (3.0mm)

## Materials & Finishes

<b>Housing/Bezel:</b>	Glass fiber reinforced polyamide (UL94V-0)
<b>Snap-in Frame:</b>	Stainless steel
<b>Base:</b>	Glass fiber reinforced polyamide (UL94V-0)
<b>Movable Contactor:</b>	Phosphor bronze with silver or gold plating
<b>Movable Contacts:</b>	Silver alloy with silver plating or brass with gold plating
<b>Stationary Contacts:</b>	Silver alloy or copper with gold plating
<b>Switch Terminals:</b>	Phosphor bronze with tin plating
<b>Lamp Terminals:</b>	Phosphor bronze with tin plating

## Environmental Data

<b>Operating Temperature Range:</b>	-25°C through +50°C (-13°F through +122°F) for Illuminated -25°C through +70°C (-13°F through +158°F) for Nonilluminated
<b>Humidity:</b>	90 ~ 95% humidity for 96 hours @ 40°C (104°F)
<b>Vibration:</b>	10 ~ 55Hz with peak-to-peak amplitude of 1.5mm traversing the frequency range & returning in 1 minute; 3 right angled directions for 2 hours
<b>Shock:</b>	50G (490m/s <sup>2</sup> ) acceleration (tested in 6 right angled directions, with 5 shocks in each direction)
<b>Sealing:</b>	IP65 of IEC60529 standard for panel seal models

## Installation

<b>Mounting Torque:</b>	0.785Nm (6.95 lb•in) maximum
<b>Quick Connect Force:</b>	24.5N maximum downward force on connector
<b>Soldering Time &amp; Temperature:</b>	Manual Soldering: See Profile A in Supplement section.

## Standards & Certifications

<b>Flammability Standards:</b>	UL94V-0 housing & base
<b>UL:</b>	<b>File No. E44145 - Recognized only when ordered with marking on switch.</b> Add "/U" or "/CUL" before first dash in part number to order UL recognized switch. All solder lug models recognized at 3A @ 125/250V AC or 0.4VA @ 28V AC/DC maximum.
<b>CSA:</b>	<b>File No. 023535_0_000 - Certified only when ordered with marking on switch.</b> Add "/C" before first dash in part number to order CSA certified switch. All solder lug models certified at 3A @ 125/250V AC or 0.4VA @ 28V AC/DC maximum.

# Distinctive Characteristics

Full face or spot illumination with incandescent lamps or multi-element LEDs, with or without resistors.

Choice of super bright LEDs in white, green, and blue as well as bright LEDs in red, amber, and green.

Combination bezel-barrier is an integral part of the switch and prevents accidental actuation.

Unique thermoplastic elastomer seal inside caps plus rolled sleeve of nitrile butadiene rubber at joining of housing and inner case, all for added protection to interior mechanism.

Dust and oil tight as well as splashproof panel seal models qualify to IP65 of IEC60529 Standards (similar to NEMA 4 and 13). Panel seal models provided with exterior o-ring.

Distinctive design of snap-action contacts for shock resistance, long life, and sensitive actuation.

High density design to give behind panel depth of less than one inch.

Terminals are epoxy sealed to lock out flux, dust, solvents, and other contaminants.

Latchdown for indication of circuit status, plus audible, tactile feedback with smooth, responsive operation.

Matching indicators available.

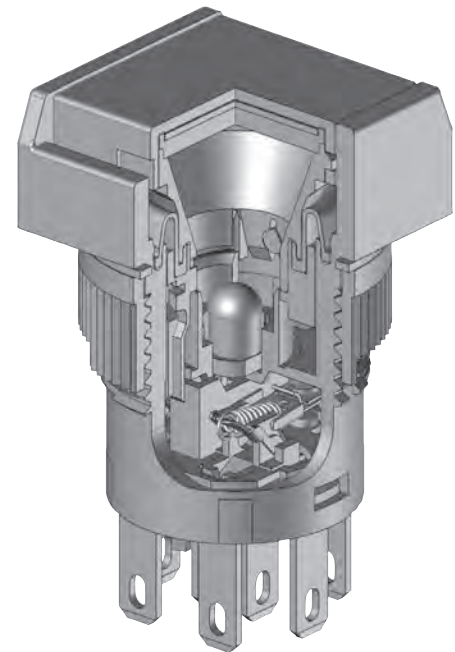

Actual Size

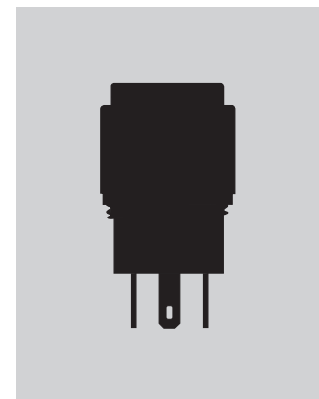

Toggle

Rockers

Pushbuttons

**D** Illuminated PB

Programmable

Keylocks

Rotaries

Slides

Tactiles

Tilt

Touch

Indicators

Accessories

Supplement

### TYPICAL SWITCH

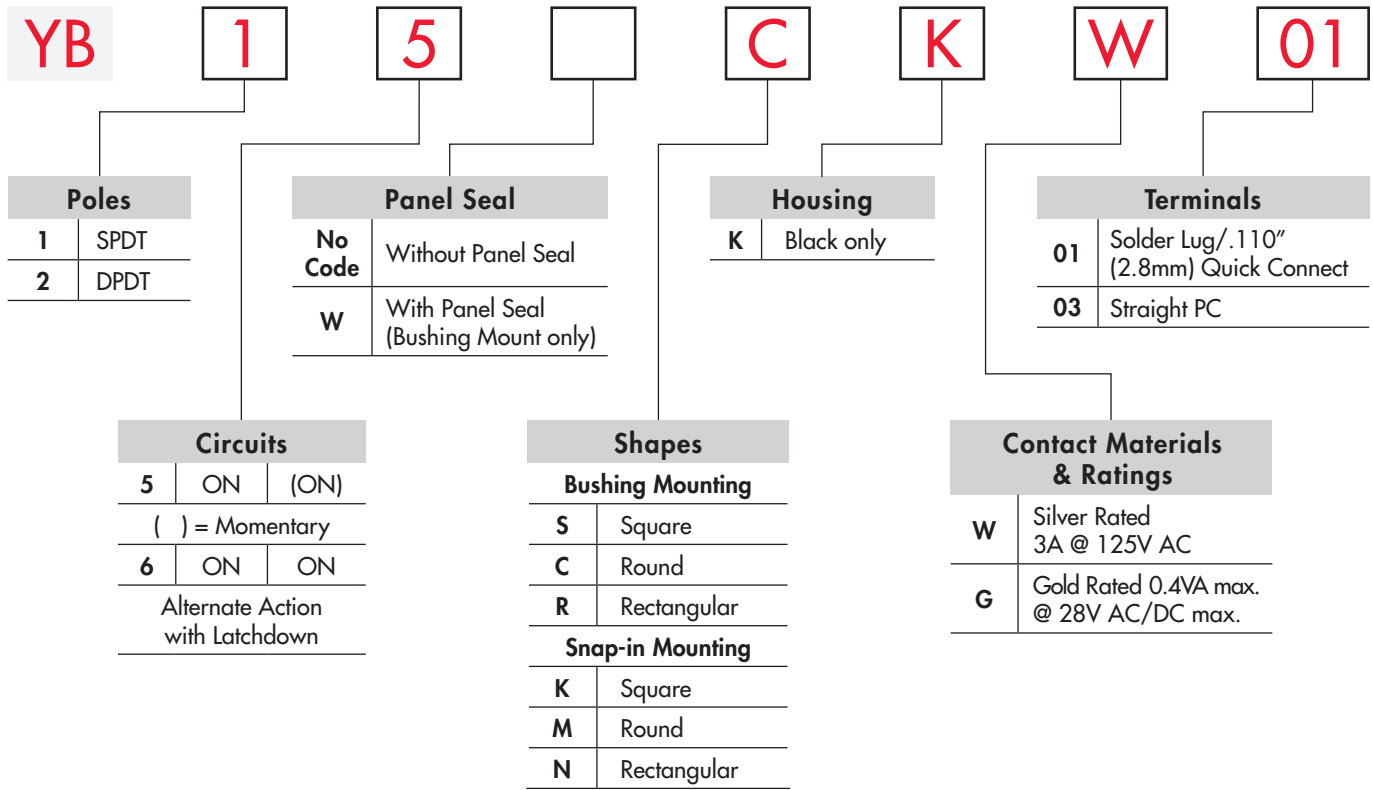

#### IMPORTANT:



Switches are supplied without UL & cULus marking unless specified. **UL & cULus recognized only when ordered with marking on switch.** Specific models, ratings, & ordering instructions are noted on the General Specifications page.

#### DESCRIPTION FOR TYPICAL ORDERING EXAMPLE

#### YB15CKW01-6F-JB

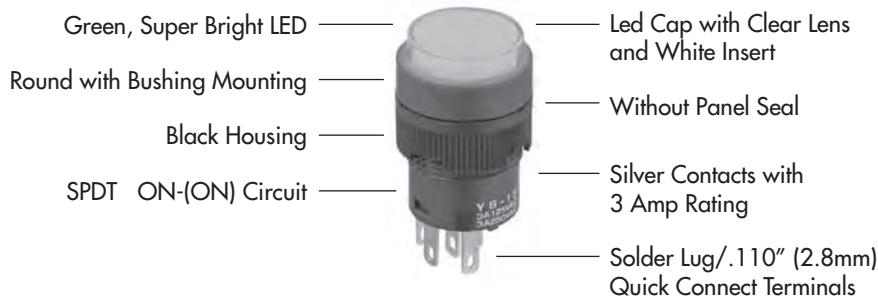

## ORDERING EXAMPLE

6 F

JB

### Lamps

#### Incandescent Lamp

05	5-volt
12	12-volt
No Code	Nonilluminated

#### LED for Spot Illuminated Cap

LED Colors		Forward Voltage	
1C	Red	02	2-volt (no resistor)
1D	Amber		
1F	Green	05	5-volt
1CF	Red/Green	12	12-volt
		24	24-volt

#### Bright LED

LED Colors		Resistor	
5C	Red	No Code	No Resistor
5D	Amber	05	5-volt
		12	12-volt
5F	Green	24	24-volt

#### Super Bright LED

6B	White
6F	Green
6G	Blue

#### Bicolor LED for Full Face Illuminated

LED Colors		Forward Voltage	
2CF	Red/Green	02	2-volt (no resistor)
		05	5-volt
		12	12-volt
		24	24-volt

### Cap Types & Colors

#### Solid Cap: Lens/Insert Colors

BB	White/White
CB	Red/White
EB	Yellow/White
FB	Green/White
GB	Blue/White

#### Spot Illuminated Cap: Lens/Insert Colors

JA	Clear/Black
JB	Clear/White
JC	Clear/Red
JE	Clear/Yellow
JF	Clear/Green

#### LED Cap: Lens/Insert Colors

JB	Clear/White
JC	Clear/Red
JD	Clear/Amber
JF	Clear/Green

#### LED Cap: Lens/Insert Colors

JB	Clear/White
----	-------------

#### LED Cap: Lens/Insert Colors

JB	Clear/White
----	-------------

Toggles

Rockers

Pushbuttons

Illuminated PB

Programmable

Keylocks

Rotaries

Slides

Tactiles

Tilt

Touch

Indicators

Accessories

Supplement

## POLES & CIRCUITS

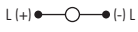
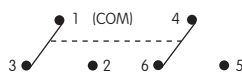
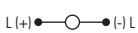
Pole	Model	Plunger Position ( ) = Momentary		Connected Terminals		Throw & Switch/Lamp Schematics
		Normal	Down	Normal	Down	
SP	YB15 *YB16	ON ON	(ON) ON	1-3	1-2	Notes: Switch is marked with NC, NO, COM, L+, L-. Lamp circuit is isolated and requires external power source.  
DP	YB25 *YB26	ON ON	(ON) ON	1-3 4-6	1-2 4-5	 

\* When in latched position for the alternate circuit, cap position is .020" (0.5mm) above the built-in bezel.

## PANEL SEAL

**No Code**

Without Panel Seal

Bushing Mounting

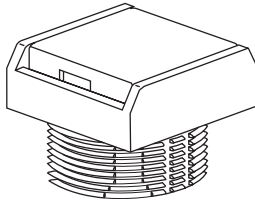

Supplied with mounting nut.

Snap-in Mounting

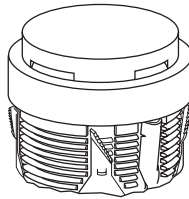

**W**

With Panel Seal

Bushing Mounting only

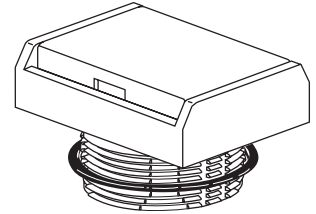

Supplied with mounting nut and o-ring AT089.

## SHAPES & MOUNTING TYPES

Bushing Mounting

Snap-in Mounting

**S**

Square

**C**

Round

**R**

Rectangular

**K**

Square

**M**

Round

**N**

Rectangular

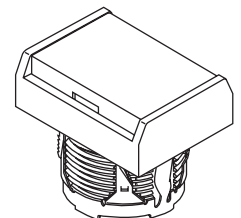
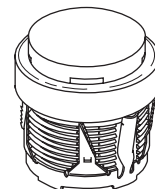
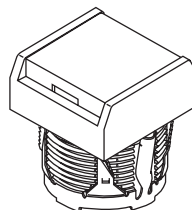
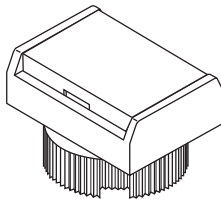
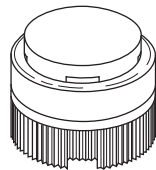
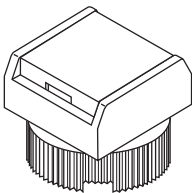

Bezel-barrier is an integral part of the switch body.

## HOUSING

**K**

Black

Housing available in black only. The 1-piece body and bezel-barrier have a matte finish.

## CONTACT MATERIALS & RATINGS

**W**

Silver Contacts

Power Level

3A @ 125/250V AC

**G**

Gold Contacts

Logic Level

0.4VA max. @ 28V AC/DC max.

Complete explanation of operating range in Supplement section.

## TERMINALS

**01** Solder Lug/  
.110" (2.8mm) Quick Connect

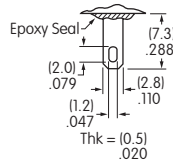

**03** Straight PC

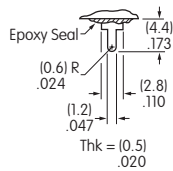

Single Pole

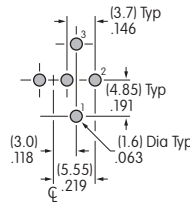

Double Pole

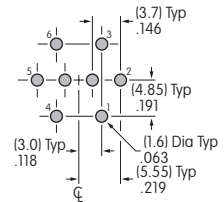

## INCANDESCENT LAMP & SOLID CAP

Electrical specifications are determined at a basic temperature of 25°C. Lamp circuit is independent of switch operation. For dimension drawing of lamp see the Accessories & Hardware section.

AT611	Voltage	V	<b>05</b>	<b>12</b>
			5V AC	12V AC
Current	I	115mA	60mA	
MSCP		.150	.150	
Endurance	Hours	7,000 average		
Ambient Temperature Range		-25°C ~ +50°C		



T-1 Bi-pin

**No Code** No Lamp

### Solid Cap for Incandescent Lamp & Nonilluminated

Lens/Insert  
Colors Available:

- BB** White/White
- CB** Red/White
- EB** Yellow/White
- FB** Green/White
- GB** Blue/White

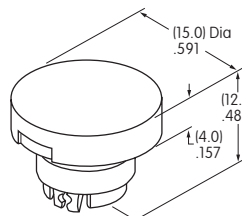

**AT3002**  
Round

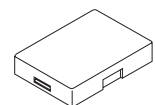

Translucent Colored Lens

**AT3001**  
Square

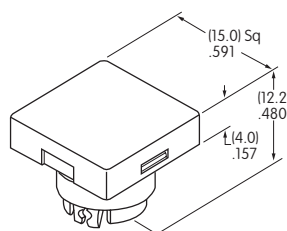

**AT3003**  
Rectangular

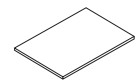
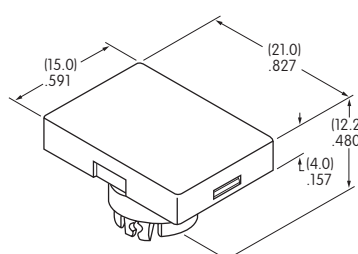

Translucent White Insert

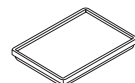

Translucent White Seal/Filter

**Materials:**

Lens & Insert: Polycarbonate Seal/Filter: Thermoplastic Elastomer



Incandescent Lamp AT611

## SPOT ILLUMINATED CAP WITH BUILT-IN LED

This spot-illuminated cap is factory assembled.

**AT3010**  
Square

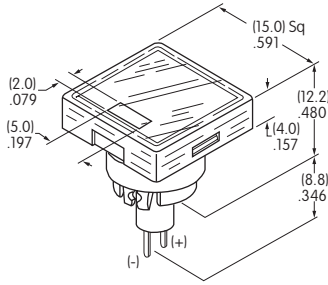

**AT3011**  
Round

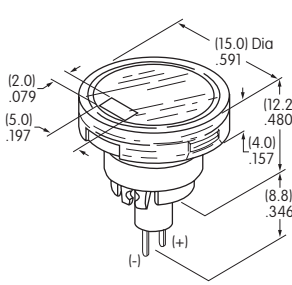

**AT3012**  
Rectangular

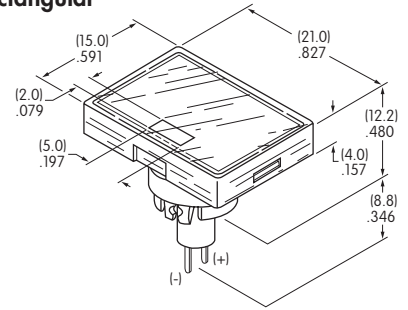

**Colors Available:**

**1C**

Red

**1D**

Amber

**1F**

Green

**1CF**

Red/Green

**02**

Without Resistor

**05**

With Resistor

**12**

With Resistor

**24**

With Resistor

Unit

Maximum Forward Current	$I_{FM}$	20	15	15	12	mA
Typical Forward Current	$I_F$	15	12.5	12.5	10	mA
Forward Voltage	$V_F$	2.1	5	12	24	V
Maximum Reverse Voltage (not applicable to bicolor)	$V_{RM}$	5	5	5	5	V
Current Reduction Rate Above 25°C	$\Delta I_F$	0.27	—	—	—	mA/°C
Ambient Temperature Range		-25 ~ +50				°C

Without Resistor 2-volt

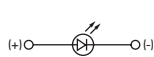

Single Color

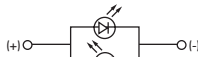

Bicolor

With Resistor 5, 12, 24-volt



Single Color

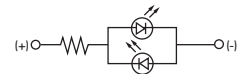

Bicolor

The electrical specifications shown are determined at a basic temperature of 25°C. LED circuit is isolated and requires external power source. Single color LEDs are colored in OFF state. Bicolor LED is translucent white in OFF state.

If the source voltage exceeds the rated voltage, a ballast resistor is required.

The resistor value can be calculated by using the formula in the Supplement section.

**Lens/Insert**  
**Colors Available:**

**JA**

Clear/Black

**JB**

Clear/White

**JC**

Clear/Red

**JE**

Clear/Yellow

**JF**

Clear/Green



Clear Lens

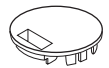

Colored Insert



Seal

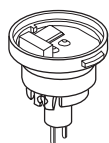

Built-in LED  
(integral part  
of the cap)

Example part number  
when cap is ordered separate  
from switch:

**AT3010F02JA**

for a

Square Spot Illuminated Cap  
with Green 2-volt LED  
without resistor  
Clear Lens and Black Insert

**Materials:**

Lens & Insert: Polycarbonate  
Seal: Thermoplastic Elastomer



## BRIGHT LED & LED CAPS

The electrical specifications shown are determined at a basic temperature of 25°C.  
 LED circuit is isolated and requires external power source.  
 If the source voltage exceeds the rated voltage, a ballast resistor is required.  
 The resistor value can be calculated by using the formula in the Supplement section.

### Electrical Specifications for Bright LED without Resistor

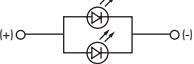
<b>Bright AT628</b>      T-1 Bi-pin	<b>Colors Available:</b> <span style="border: 1px solid black; padding: 2px;">5C</span> Red <span style="border: 1px solid black; padding: 2px;">5D</span> Amber <span style="border: 1px solid black; padding: 2px;">5F</span> Green <span style="border: 1px solid black; padding: 2px; margin-left: 20px;">No Code</span> No Resistor	Unit				
	LED Colors	Red	Amber	Green		
	Maximum Forward Current	$I_{FM}$	40	40	40	mA
	Typical Forward Current	$I_F$	26	26	26	mA
	Forward Voltage	$V_F$	1.9	2.0	2.0	V
	Maximum Reverse Voltage	$V_{RM}$	4	4	4	V
	Current Reduction Rate Above 25°C	$\Delta I_F$	0.50			mA/°C
Ambient Temperature Range	-25 ~ +50			°C		

### Electrical Specifications for Bright LED with Resistor

<b>Bright AT634</b>    T-1½ Bi-pin	<b>Colors Available:</b> <span style="border: 1px solid black; padding: 2px;">5C</span> Red <span style="border: 1px solid black; padding: 2px;">5D</span> Amber <span style="border: 1px solid black; padding: 2px;">5F</span> Green <span style="border: 1px solid black; padding: 2px; margin-left: 20px;">05</span> <span style="border: 1px solid black; padding: 2px; margin-left: 20px;">12</span> <span style="border: 1px solid black; padding: 2px; margin-left: 20px;">24</span>	Unit				
	Maximum Forward Current	$I_{FM}$	—	—	—	mA
	Typical Forward Current	$I_F$	25	20	10	mA
	Forward Voltage	$V_F$	5	12	24	V
	Maximum Reverse Voltage	$V_{RM}$	4	8	16	V
	Current Reduction Rate Above 25°C	$\Delta I_F$	—	—	—	mA/°C
Ambient Temperature Range	-25 ~ +50			°C		

AT634  
5-volt,  
2-element  
with Resistor

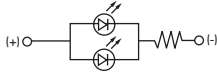

AT634  
12-volt,  
4-element  
with Resistor



AT634  
24-volt,  
4-element  
with Resistor



### Cap for Bright LED

Lens/Insert  
Colors Available:

- JB Clear/White
- JC Clear/Red
- JD Clear/Amber
- JF Clear/Green

AT3004  
Square

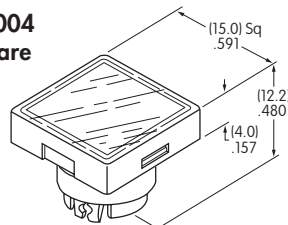

AT3005  
Round

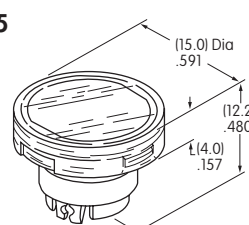

AT3006  
Rectangular

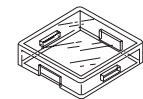
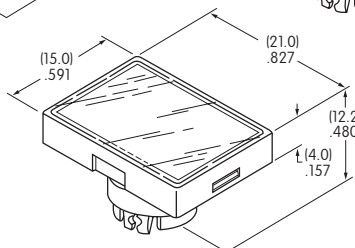

Transparent Clear Lens

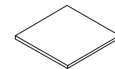

Translucent Colored Insert



Translucent White Seal/Diffuser



Bright LEDs  
AT628 AT634



**Materials:**

Lens & Insert: Polycarbonate Seal/Diffuser: Thermoplastic Elastomer

### SUPER BRIGHT LED & LED CAPS

The electrical specifications shown are determined at a basic temperature of 25°C.  
 LED circuit is isolated and requires external power source.  
 If the source voltage exceeds the rated voltage, a ballast resistor is required.  
 The resistor value can be calculated by using the formula in the Supplement section.

#### Electrical Specifications for Super Bright LED

Super Bright AT625G Blue AT631B White AT632F Green	 	6B	6F	6G	Unit	
		Colors:	White	Green		Blue
 T-1 Bi-pin	Maximum Forward Current	$I_{FM}$	30	30	30	mA
	Typical Forward Current	$I_F$	20	20	20	mA
	Forward Voltage	$V_F$	3.3	3.3	3.3	V
	Maximum Reverse Voltage	$V_{RM}$	7	7	7	V
	Current Reduction Rate Above 25°C	$\Delta I_F$	0.40	0.40	0.40	mA/°C
	Ambient Temperature Range		-25 ~ +50			°C

#### Cap for Super Bright LED

**AT3014**  
Square

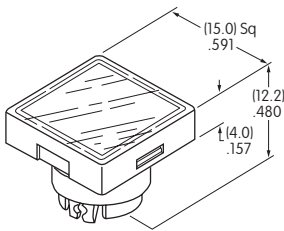

**AT3015**  
Round

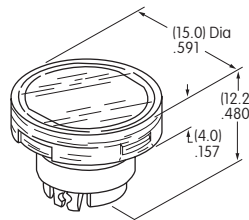

**AT3016**  
Rectangular

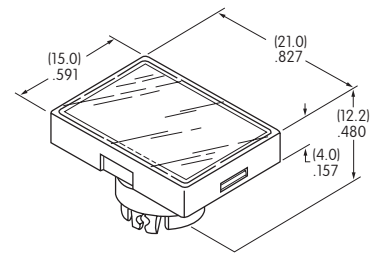

Lens/Insert  
Colors Available:

**JB** Clear/White

Transparent Clear Lens

Translucent White Insert

Translucent White Seal/Diffuser



Super Bright LEDs  
AT625 AT631  
AT632

Materials:

Lens & Insert: Polycarbonate Seal/Diffuser: Thermoplastic Elastomer

## BICOLOR LED & LED CAPS

The electrical specifications shown are determined at a basic temperature of 25°C.  
 LED circuit is isolated and requires external power source.  
 If the source voltage exceeds the rated voltage, a ballast resistor is required.  
 The resistor value can be calculated by using the formula in the Supplement section.

### Electrical Specifications for Bicolor LED

Bicolor AT621 <b>2CF</b> Red/Green  T-1 1/2 Bi-pin	Bicolor LED is translucent white in OFF state.				02	05	12	24	Unit
	Maximum Forward Current	$I_{FM}$	60	60	20	12	mA		
Typical Forward Current	$I_F$	45	45	15	10	mA			
Forward Voltage (Red/Green)	$V_F$	1.9 / 2.1	5	12	24	V			
Current Reduction Rate Above 25°C	$\Delta I_F$	0.80	—	—	—	mA/°C			
Ambient Temperature Range		-25 ~ +50			°C				

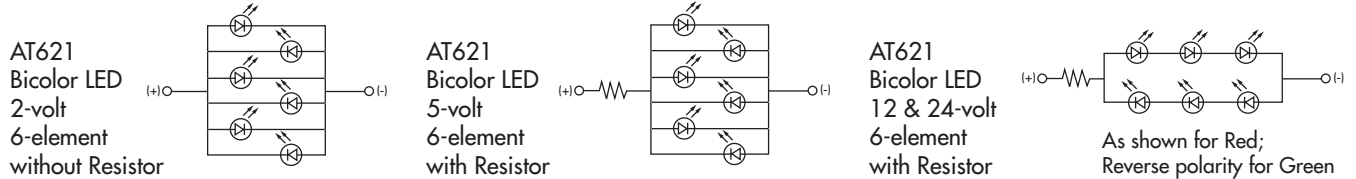

### LED Caps

**AT3004 Square**

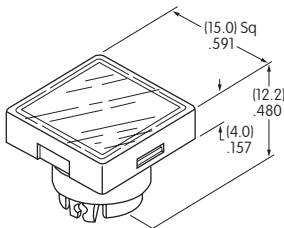

**AT3005 Round**

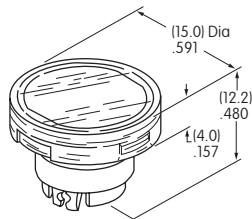

**AT3006 Rectangular**

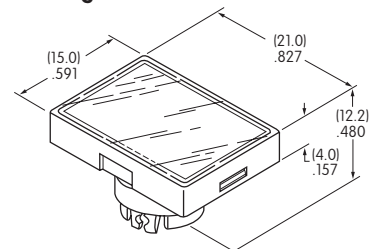

Lens/Insert  
Colors Available:

**JB** Clear/White

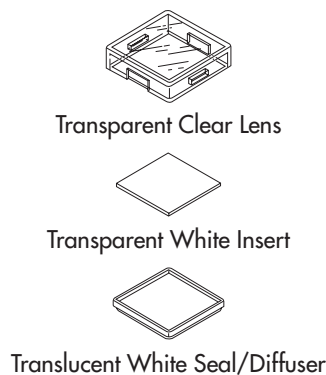

Bicolor LED AT621

**Materials:**

Lens & Insert: Polycarbonate Seal/Diffuser: Thermoplastic Elastomer

Toggle  
Rockers  
Pushbuttons  
Illuminated PB  
Programmable  
Key locks  
Rotaries  
Slides  
Tactiles  
Tilt  
Touch  
Indicators  
Accessories  
Supplement

## TYPICAL SWITCH DIMENSIONS

### Square • Bushing Mounting

### Single & Double Pole

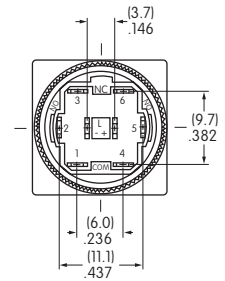
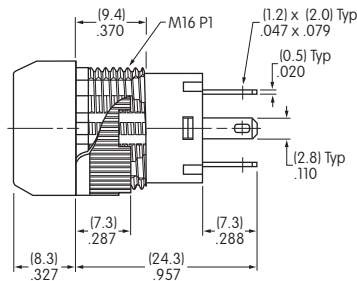
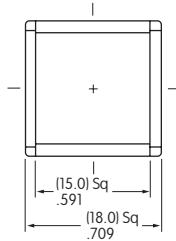

**YB15KW01-12-CB**

Single pole models do not have terminals 4, 5, & 6.

### Round • Panel Seal

### Single & Double Pole

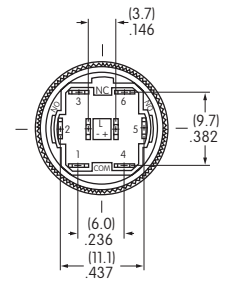
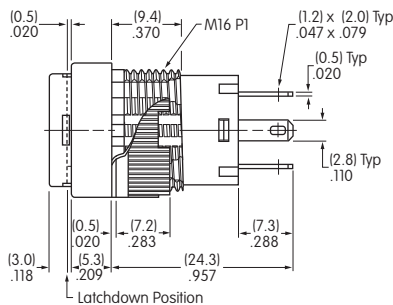
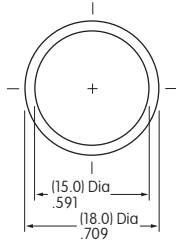

**YB26WCKW01-12-EB**

Single pole models do not have terminals 4, 5, & 6.

### Rectangular • Snap-in Mounting

### Single & Double Pole

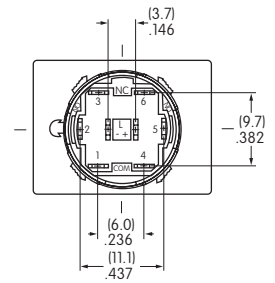
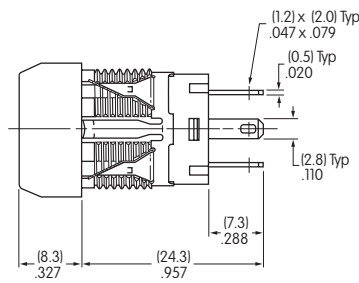
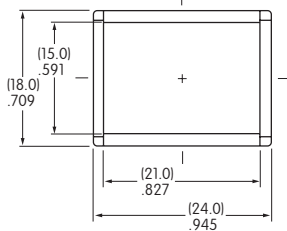

**YB15NKW01-5C-JC**

Single pole models do not have terminals 4, 5, & 6.

## PANEL THICKNESS & CUTOUTS

### Bushing & Panel Seal Mount

Panel Thickness  
.020" ~ .197"  
(0.5mm ~ 5.0mm)

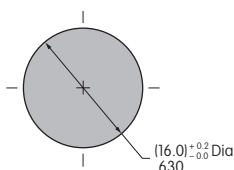

### Snap-in Mount

Panel Thickness  
.039" ~ .138"  
(1.0mm ~ 3.5mm)

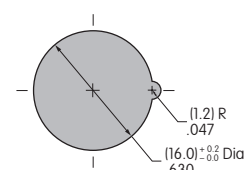

## OPTIONAL ACCESSORIES

Dust Covers and Protective Guards reduce depth of switch behind panel by .047" (1.2mm).

**Panel Thickness Range with Dust Cover or Protective Guards:**

Bushing Mounting  
.020" ~ .150" (0.5mm ~ 3.8mm)

Snap-in Mounting  
.020" ~ .091" (0.5mm ~ 2.3mm)

Panel Seal  
.020" ~ .118" (0.5mm ~ 3.0mm)

### AT4115 Dust Cover for Snap-in or Bushing Mount

### AT4115 Splash Cover and AT541 O-ring for Bushing Mount

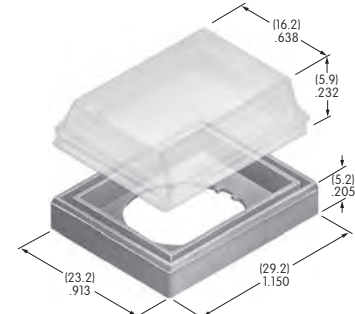
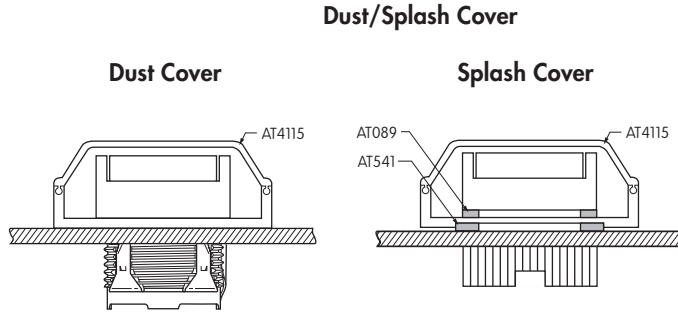

**AT4115**

**Materials:**  
Lid: Polyvinyl Chloride  
Base: Polyamide  
O-ring: Nitrile butadiene rubber

Snap-in Mount

Panel Seal

Note: AT089 o-ring supplied with panel seal model.

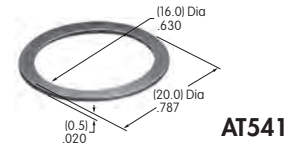

**AT541**

### AT4072 Protective Guard

Opens 90°  
Closes manually

**Materials:**  
Lid: Polycarbonate  
Base: Glass Fiber Reinforced Polycarbonate



### Protective Guard

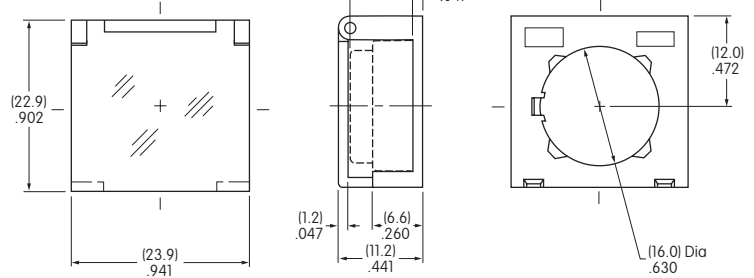

### Spring Loaded Protective Guard

### AT4175 Spring Loaded Protective Guard

Opens 180°  
Closes automatically

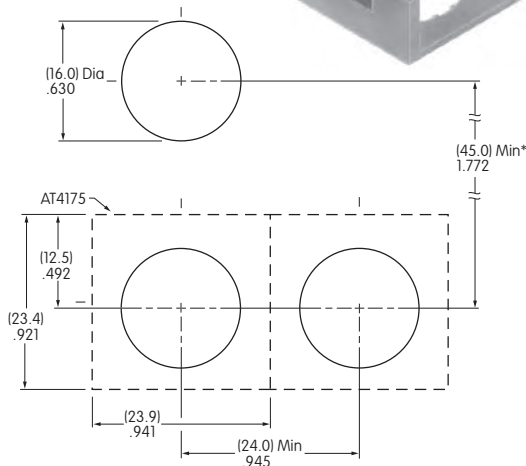

**Materials:**  
Lid: Polycarbonate  
Base: Glass Fiber Reinforced Polyamide  
Coil Spring: Stainless Steel

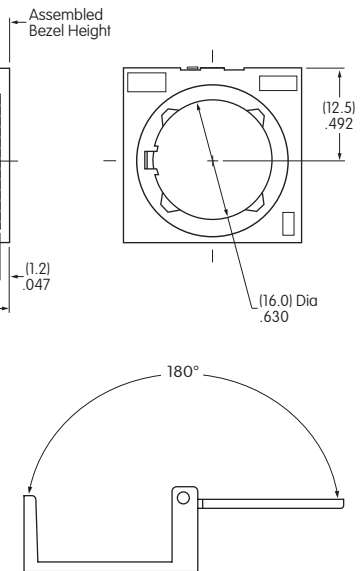

\* Minimum dimension allows opening of cover to 180°

## OPTIONAL ACCESSORIES

### Adaptors

**AT716**  
Single Pole  
Solder Lug/  
Quick Connect  
Terminals

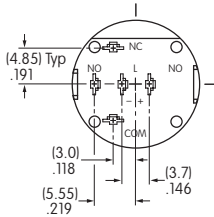
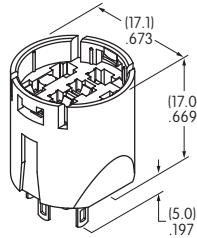

**AT717**  
Double Pole  
Solder Lug/  
Quick Connect  
Terminals

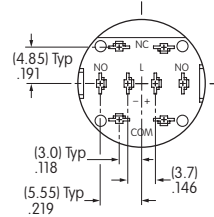
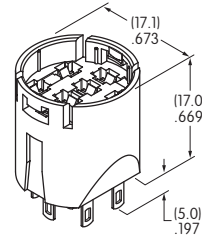

**AT718**  
Single Pole  
Straight PC  
Terminals

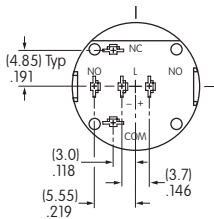
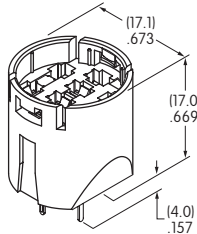

**AT719**  
Double Pole  
Straight PC  
Terminals

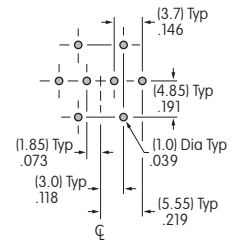
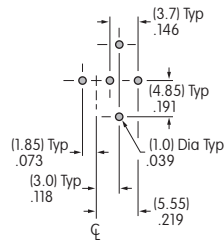
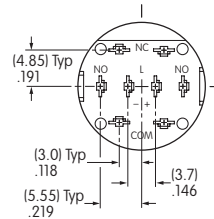
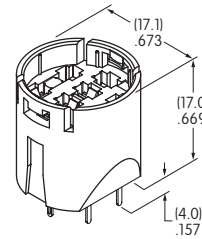

Material: Glass fiber reinforced polyamide    Note: Order adaptors separately

### Switch Dimensions Shown with Adaptor AT716

Dimension A:

Solder Lug .197" (5.0mm); Straight PC .157" (4.0mm)

Panel thickness for YB Bushing Mount:

.020" ~ .197" (0.5mm ~ 5.0mm)

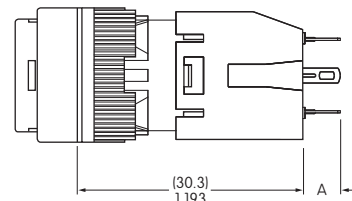

## ASSEMBLY INSTRUCTIONS

### Cap Assembly

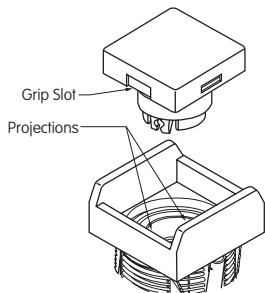

### LED Polarity & Orientation in Lamp Socket

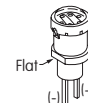
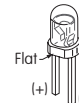
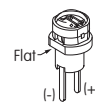
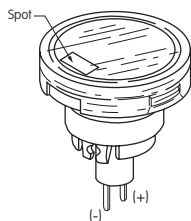
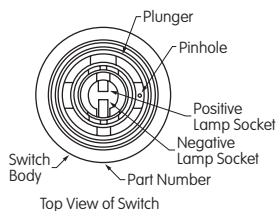

Spot Illuminated Cap with Built-in LED

LED AT628 AT634

LEDs AT625G AT631B AT632F

LED AT621

The following installation tools are available: AT106 Socket Wrench for bushing mounting (Overtightening the mounting nut AT092 may damage the switch housing.); AT109 Cap Extractor; AT111 Lamping Tool. Further details and dimensions are shown in the Accessories and Hardware section.

## LEGENDS

NKK Switches can provide custom legends for caps. Contact factory for more information.

### Suggested Printable Area for YB Lens

**Recommended Methods:** Laser Etch on clear lens, Screen Print or Pad Print on Lens. Epoxy based ink is recommended.

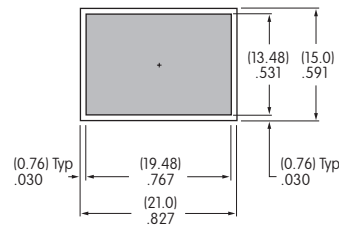
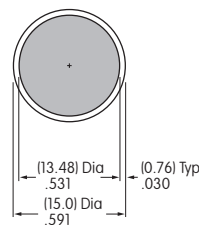
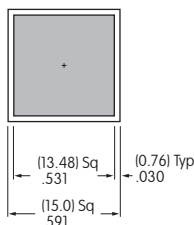

Shaded areas are printable areas.

### Suggested Printable Area for Film Insert

**Recommended Print Method:** Laser Print  
 Film Insert: Clear Polyester, 4 mil max. thickness

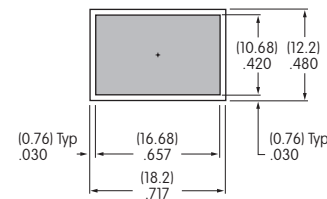
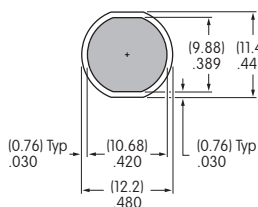
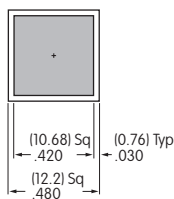
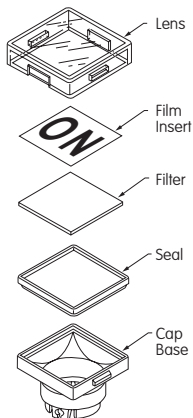

Shaded areas are printable areas.

Toggles  
 Rockers  
 Pushbuttons  
**D Illuminated PB**  
 Programmable  
 Keylocks  
 Rotaries  
 Slides  
 Tactiles  
 Tilt  
 Touch  
 Indicators  
 Accessories  
 Supplement

# General Specifications

## Electrical Capacity (Resistive Load)

<b>Power Level (silver):</b>	3A @ 125V AC or 3A @ 250V AC or 3A @ 30V DC
<b>Logic Level (gold):</b>	0.4VA maximum @ 28V AC/DC maximum (Applicable Range 0.1mA ~ 0.1A @ 20mV ~ 28V)

## Other Ratings

<b>Contact Resistance:</b>	50 milliohms maximum for silver; 100 milliohms maximum for gold
<b>Insulation Resistance:</b>	200 megohms minimum @ 500V DC
<b>Dielectric Strength:</b>	1,000V AC minimum between contacts for 1 minute minimum; 1,500V AC minimum between contacts & case for 1 minute minimum
<b>Mechanical Life:</b>	1,000,000 operations minimum for momentary circuit 200,000 operations minimum for maintained circuit
<b>Electrical Life:</b>	100,000 operations minimum
<b>Nominal Operating Force:</b>	Single pole: 1.5N Double pole: 3.0N
<b>Contact Timing:</b>	Nonshorting (break-before-make)
<b>Travel:</b>	Pretravel .059" (1.5mm); Overtravel .059" (1.5mm); Total Travel .118" (3.0mm)

## Materials & Finishes

<b>Bezel:</b>	Black: Glass fiber reinforced polyamide (UL94V-0); Chrome plated: Chrome plating over ABS resin (UL94V-2)
<b>Housing:</b>	Glass fiber reinforced polyamide (UL94V-0)
<b>Base:</b>	Glass fiber reinforced polyamide (UL94V-0)
<b>Movable Contactor:</b>	Phosphor bronze with silver or gold plating
<b>Movable Contacts:</b>	Silver alloy or copper with gold plating
<b>Stationary Contacts:</b>	Silver alloy or copper with gold plating
<b>Switch Terminals:</b>	Phosphor bronze with tin plating
<b>Lamp Terminals:</b>	Phosphor bronze with tin plating

## Environmental Data

<b>Operating Temperature Range:</b>	-25°C through +50°C (-13°F through +122°F) for Illuminated -25°C through +70°C (-13°F through +158°F) for Nonilluminated
<b>Humidity:</b>	90 ~ 95% humidity for 240 hours @ 40°C (104°F)
<b>Vibration:</b>	10 ~ 55Hz with peak-to-peak amplitude of 1.5mm traversing the frequency range & returning in 1 minute; 3 right angled directions for 2 hours
<b>Shock:</b>	50G (490m/s <sup>2</sup> ) acceleration (tested in 6 right angled directions, with 5 shocks in each direction)
<b>Sealing:</b>	IP65 of IEC60529 standard

## Installation

<b>Mounting Torque:</b>	0.785Nm (6.95 lb•in) maximum
<b>Soldering Time &amp; Temperature:</b>	Manual Soldering: See Profile A in Supplement section.

## Standards & Certifications

<b>Flammability Standards:</b>	UL94V-0 housing, base & black bezel
<b>UL:</b>	<b>File No. E44145 - Recognized only when ordered with marking on switch.</b> Add "/CUL" before first dash in part number to order cULus marking on switch. All solder lug models recognized at 3A @ 125/250V AC or 0.4VA @ 28V AC/DC maximum.



# Distinctive Characteristics

24mm square and 25mm diameter pushbuttons with the shortest above-panel dimension (1.8mm) in the industry for splashproof design.

Meets IP65 of IEC60529 standards (similar to NEMA 4 and 13), providing dust tight and splashproof panel seal protection.

Tamper resistant 18mm square and 19mm diameter actuators.

Short body of .965" (24.5mm) conserves behind-panel space.

Distinctive long stroke and light touch actuation for clear indication of circuit status.

Choice of cap colors includes clear, brushed chrome, red, green, or yellow, for enhanced panel appearance. Metallic silver cap option has bright ring illumination (round only). Unbrushed chrome has the look of stainless steel when non-illuminated, and LED color or legends when illuminated.

Brilliant illumination with multiple LED colors.

Bezel color options in black or brushed chrome.

Brushed chrome option is lighter weight than actual metal switches due to metal plating on resin.

Available in momentary and alternate action with latchdown.

Crisp actuation and clear circuit status provided by snap-action contact mechanism. Arc barrier protects against crossover.

Combination solder lug and .110" quick connect terminals. Terminals are epoxy sealed to lock out flux, dust, solvents, and other contaminants, as well as to secure terminals and improve contact stability.

Custom legends on actuator or inserts.

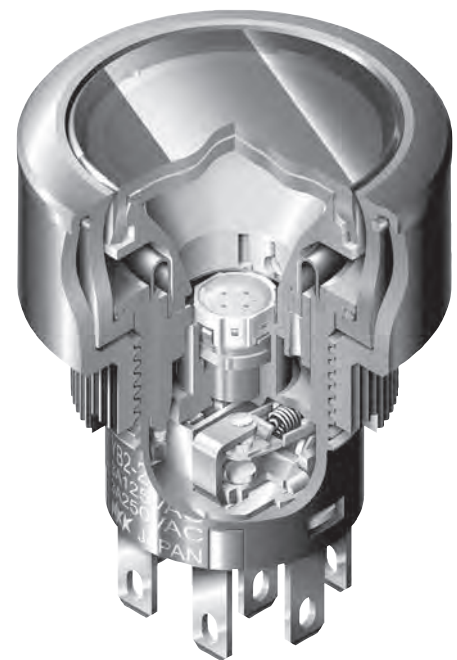

Actual Size (Round)

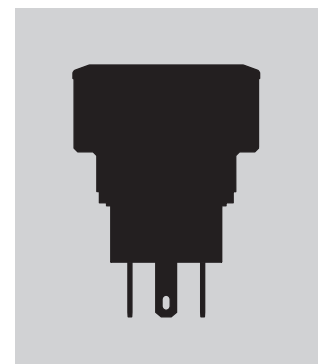

- Toggle
- Rockers
- Pushbuttons
- D** Illuminated PB
- Programmable
- Key locks
- Rotaries
- Slides
- Tactiles
- Tilt
- Touch
- Indicators
- Accessories
- Supplement

### TYPICAL SWITCH

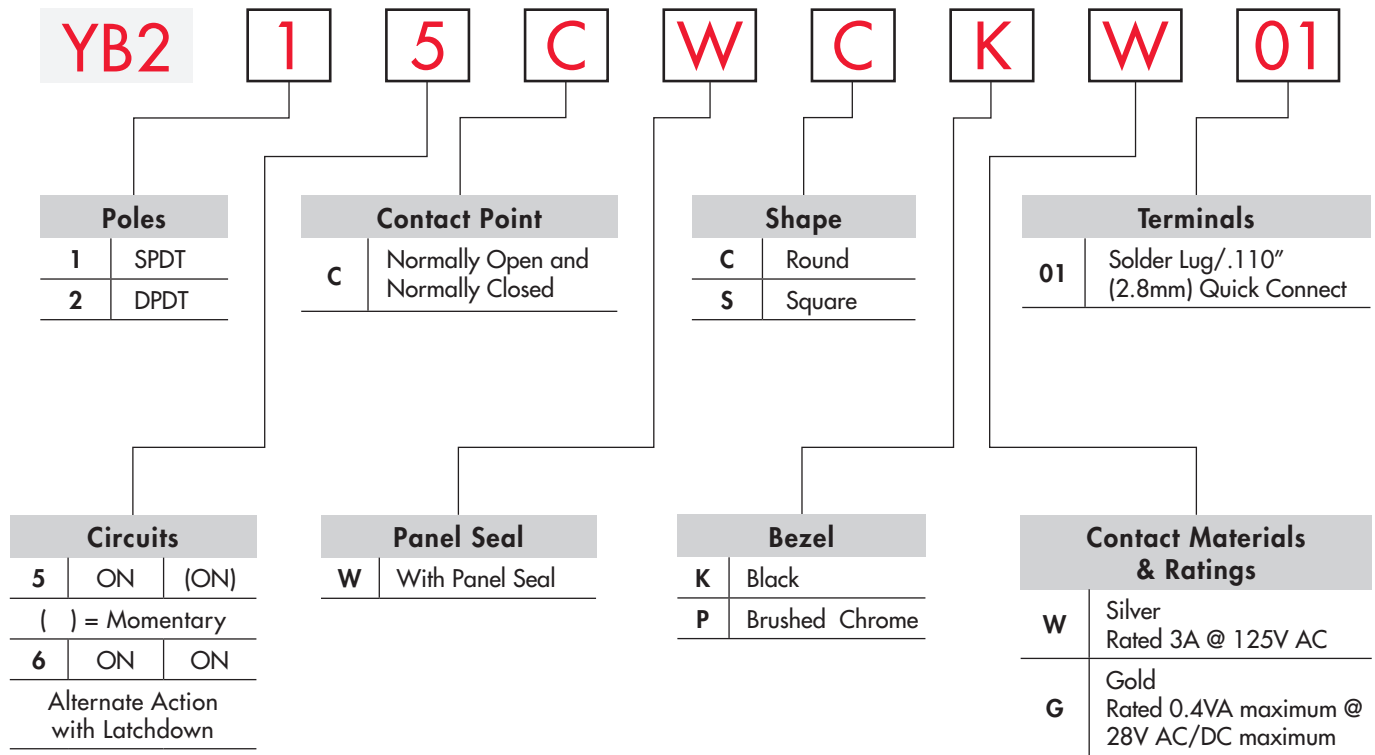

#### IMPORTANT:



Switches are supplied without cULus marking unless specified.  
**cULus recognized only when ordered with marking on the switch.**  
 Specific models, ratings, and ordering instructions are noted on  
 General Specifications page.

#### DESCRIPTION FOR TYPICAL ORDERING EXAMPLE

#### YB215CWCKW01-6B-JB



ORDERING EXAMPLE

6 B

JB

**LEDS**

**Bright LED**

LED Colors		Resistor	
5C	Red	<b>No Code</b>	No Resistor (not for Green)
5D	Amber		05 5-volt
5F	Green	12	12-volt
		24	24-volt

**Super Bright LED**

6B	White
6F	Green
6G	Blue

**Nonilluminated**

N	No Lamp
---	---------

**Cap Types & Colors**

**Lens/Diffuser Colors**

JB	Clear/White
JS	Metallic Silver Cap/Clear Ring (Round only)
CB	Red/White
EB	Yellow/White
FB	Green/White
HB	Unbrushed Chrome/White

LED and cap need to be the same color. Yellow cap pairs with amber LED to achieve amber illumination. Codes JB and JS (Round only) may be combined with all LED colors.

**Lens/Diffuser Cap Colors**

JB	Clear/White
JS	Metallic Silver Cap/Clear Ring (Round only)
HB	Unbrushed Chrome/White

**Cap Color**

JB	Clear/White
CB	Red/White
EB	Yellow/White
FB	Green/White
HB	Unbrushed Chrome/White
P	Brushed Chrome

**Round or Square Cap with Legend**

001	
002	START
003	STANDBY
004	STOP
005	

Contact factory for custom options.

**Round or Square Cap with Legend**

001	
002	START
003	STANDBY
004	STOP
005	

Contact factory for custom options.

Part Numbers for Unbrushed Chrome Caps with Legends		
Round Cap for Bright LED	Round Cap for Super Bright LED	Square Cap for Bright or Super Bright LED
AT3017HB-001	AT3018HB-001	AT3025HB-001
AT3017HB-002	AT3018HB-002	AT3025HB-002
AT3017HB-003	AT3018HB-003	AT3025HB-003
AT3017HB-004	AT3018HB-004	AT3025HB-004
AT3017HB-005	AT3018HB-005	AT3025HB-005

Refer to Ordering Table for legend that corresponds with last 3 digits of part number.

Toggles

Rockers

Pushbuttons

Illuminated PB

Programmable

Keylocks

Rotaries

Slides

Tactiles

Tilt

Touch

Indicators

Accessories

Supplement

## POLES & CIRCUITS

		Plunger Position ( ) = Momentary		Connected Terminals		Throw & Switch/Lamp Schematics
Pole	Model	Normal	Down	Normal	Down	
SP	YB215 YB216	ON ON	(ON) ON	1-3	1-2	Notes: Switch is marked with NC, NO, COM, L+, L-. Lamp circuit is isolated and requires an external power source. 
DP	YB225 YB226	ON ON	(ON) ON	1-3 4-6	1-2 4-5	

## CONTACT POINT

**C** Normally Open and Normally Closed

Contact points are both Normally Open and Normally Closed.

## PANEL SEAL

**W** Panel Seal (Round and Square)

Two o-rings provide panel seal protection meeting IP65 of IEC60529 standards.

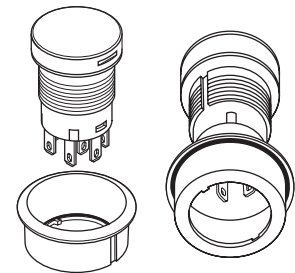

## SHAPE

**C** Round

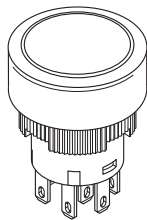

**S** Square

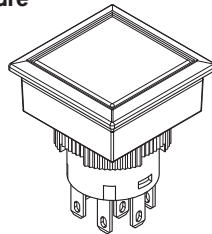

## BEZEL

**K** Black

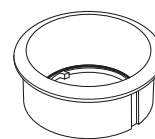

**P** Brushed Chrome

For Round or Square

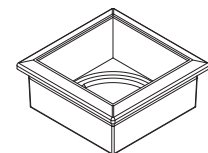

## CONTACT MATERIALS & RATINGS

**W** Silver Contacts

Power Level: 3A @ 125/250V AC  
Switch base is black

**G** Gold Contacts

Logic Level: 0.4VA max. @ 28V AC/DC max.  
Switch base is ivory

## TERMINALS

**01** Solder Lug/  
.110" (2.8mm) Quick Connect

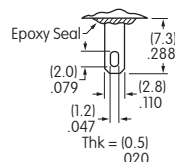

**BRIGHT & SUPER BRIGHT LEDs**

The electrical specifications shown are determined at a basic temperature of 25°C. LED circuit is isolated and requires an external power source. If the source voltage exceeds the rated voltage, a ballast resistor is required. Base of AT634 and AT636 is Black for 5V, Light Blue for 12V and Gray for 24V.

**Electrical Specifications for Bright LED without Resistor**

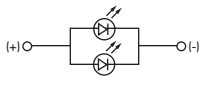
<b>Bright AT628</b>  T-1 Bi-pin 	<b>Colors Available:</b> <span style="border: 1px solid black; padding: 2px;">5C</span> Red <span style="border: 1px solid black; padding: 2px;">5D</span> Amber <span style="border: 1px solid black; padding: 2px;">No Code</span> No Resistor	Unit
	LED Colors	Red Amber
	Maximum Forward Current	$I_{FM}$ 40 40 mA
	Typical Forward Current	$I_F$ 26 26 mA
	Forward Voltage	$V_F$ 1.9 2.0 V
	Maximum Reverse Voltage	$V_{RM}$ 4 4 V
	Current Reduction Rate Above 25°C	$\Delta I_F$ 0.50 mA/°C
Ambient Temperature Range	-25 ~ +50 °C	

**Electrical Specifications for Bright Red & Amber LED with Resistor**

<b>Bright AT634</b>  T-1½ Bi-pin	<b>Colors Available:</b> <span style="border: 1px solid black; padding: 2px;">5C</span> Red <span style="border: 1px solid black; padding: 2px;">5D</span> Amber <span style="border: 1px solid black; padding: 2px;">05</span> <span style="border: 1px solid black; padding: 2px;">12</span> <span style="border: 1px solid black; padding: 2px;">24</span>	Unit
	Maximum Forward Current	$I_{FM}$ — — — mA
	Typical Forward Current	$I_F$ 25 20 10 mA
	Forward Voltage	$V_F$ 5 12 24 V
	Maximum Reverse Voltage	$V_{RM}$ 4 8 16 V
	Current Reduction Rate Above 25°C	$\Delta I_F$ — — — mA/°C
	Ambient Temperature Range	-25 ~ +50 °C

AT634  
5-volt,  
2-element  
with Resistor

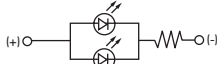



AT634  
12-volt,  
4-element  
with Resistor



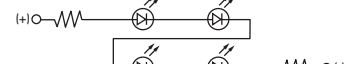

AT634  
24-volt,  
4-element  
with Resistor

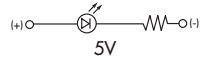
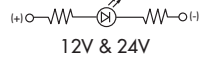

**Electrical Specifications for Bright Green LED with Resistor**

<b>Bright AT636</b>  T-1½ Bi-pin  5V  12V & 24V	<b>Colors Available:</b>  <b>ATTENTION ELECTROSTATIC SENSITIVE DEVICES</b> <span style="border: 1px solid black; padding: 2px;">5F</span> Green <span style="border: 1px solid black; padding: 2px;">05</span> <span style="border: 1px solid black; padding: 2px;">12</span> <span style="border: 1px solid black; padding: 2px;">24</span>	Unit
	Maximum Forward Current	$I_{FM}$ — — — mA
	Typical Forward Current	$I_F$ 11 9.5 8.7 mA
	Forward Voltage	$V_F$ 5 12 24 V
	Maximum Reverse Voltage	$V_{RM}$ 5 5 5 V
	Current Reduction Rate Above 25°C	$\Delta I_F$ — — — mA/°C
	Ambient Temperature Range	-25 ~ +50 °C

**Electrical Specifications for Super Bright LED**

<b>Super Bright AT625G Blue AT631B White AT632F Green</b>  T-1 Bi-pin	 <b>ATTENTION ELECTROSTATIC SENSITIVE DEVICES</b> 	<b>Colors:</b> <span style="border: 1px solid black; padding: 2px;">6B</span> White <span style="border: 1px solid black; padding: 2px;">6F</span> Green <span style="border: 1px solid black; padding: 2px;">6G</span> Blue	Unit
	Maximum Forward Current	$I_{FM}$ 30 30 30 mA	
	Typical Forward Current	$I_F$ 20 20 20 mA	
	Forward Voltage	$V_F$ 3.3 3.3 3.3 V	
	Maximum Reverse Voltage	$V_{RM}$ 7 7 7 V	
	Current Reduction Rate Above 25°C	$\Delta I_F$ 0.40 0.40 0.40 mA/°C	
	Ambient Temperature Range	-25 ~ +50 °C	

## BALLAST RESISTOR CALCULATION FOR LEDs

If the source voltage is greater than the rated voltage of a lamp or LED, a ballast resistor must be connected in series with the lamp. This circuit diagram and formula will assist in calculating the value of the required ballast resistor.

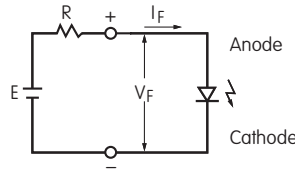

$$R = \frac{E - V_F}{I_F}$$

Where: R = Resistor Value (Ohms)  
 E = Source Voltage (V)  
 V<sub>F</sub> = Forward Voltage (V)  
 I<sub>F</sub> = Forward Current (A)

## CAPS & CAP COLORS

### AT3017 Cap for Bright LED or Nonilluminated

Lens/Diffuser Colors Available:

- JB** Clear/White
- CB** Red/White
- EB** \*Yellow/White
- FB** Green/White
- HB** Unbrushed Chrome/White

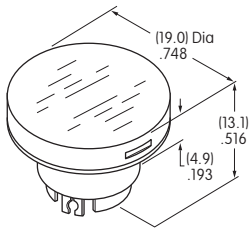

### AT3018 Cap for Super Bright LED

Lens/Diffuser Colors Available:

- JB** Clear/White
- HB** Unbrushed Chrome/White

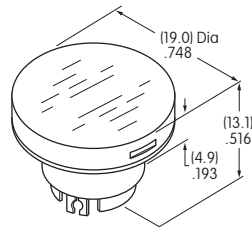

Material for Lens & Diffuser: Polycarbonate  
 HB Lens: ABS Resin & Unbrushed Chrome Plating

### AT3019 Cap for Nonilluminated

Cap Color Available:

- P** Brushed Chrome

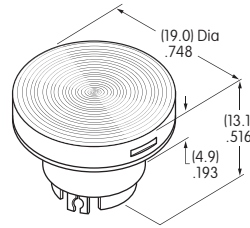

Material for Lens: ABS Resin & Brushed Chrome Plating

### AT3020 Cap with Illumination Ring for Bright or Super Bright LED

Cap Color Available:

- JS** Metallic Silver with Clear Ring

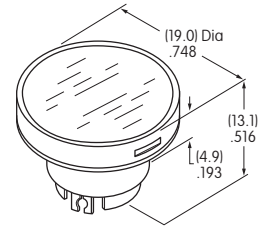

Materials  
 Lens: Polycarbonate  
 Insert: Polyester

\*Yellow cap pairs with amber LED to achieve amber illumination.

### AT3025 Cap for Illuminated or Nonilluminated

Lens/Diffuser Colors Available:

- JB** Clear/White For Bright & Super Bright LEDs
- CB** Red/White For Bright LED only
- EB** \*Yellow/White For Bright LED only
- FB** Green/White For Bright LED only
- HB** Unbrushed Chrome/White For Bright & Super Bright LEDs

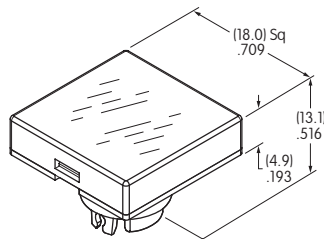

Material for Lens & Diffuser: Polycarbonate

### AT3027 Cap for Nonilluminated

Cap Color Available:

- P** Brushed Chrome

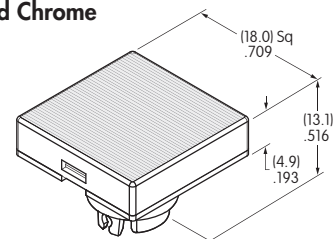

Material for Lens: ABS Resin & Brushed Chrome Plating

\*Yellow cap pairs with amber LED to achieve amber illumination.

Toggles  
Rockers  
Pushbuttons  
Illuminated PB  
Programmable  
Keylocks  
Rotaries  
Slides  
Tactiles  
Tilt  
Touch  
Indicators  
Accessories  
Supplement

Standard Legends for Unbrushed Chrome Caps

001



Round or Square Cap  
Bright or Super Bright LED

002



Round or Square Cap  
Bright or Super Bright LED

003



Round or Square Cap  
Bright or Super Bright LED

004



Round or Square Cap  
Bright or Super Bright LED

005



Round or Square Cap  
Bright or Super Bright LED

Images appear the color of the LED when lit.  
Contact factory for other legends options.

Legend illustrations are approximate representations of the actual images on the caps.

Unbrushed Chrome/White Cap with Lens/Diffuser



Without Illumination



With Illumination

Depending on the design and the color of ink used, the legend may be visible when it is not illuminated.  
It is recommended that the legend be clear and without ink in order to achieve the maximum visibility when the cap is illuminated.

Toggle

Rockers

Pushbuttons

**D** Illuminated PB

Programmable

Key locks

Rotaries

Slides

Tactiles

Tilt

Touch

Indicators

Accessories

Supplement

## TYPICAL SWITCH DIMENSIONS

Toggles

Rockers

Pushbuttons

Illuminated PB  
D

Programmable

Keylocks

Rotaries

Slides

Tactiles

Tilt

Touch

Indicators

Accessories

Supplement

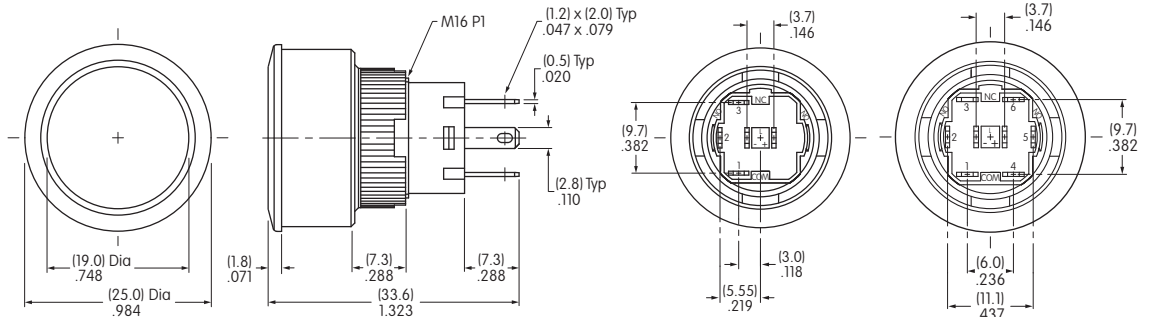

YB215CWCKW01-6B-JB

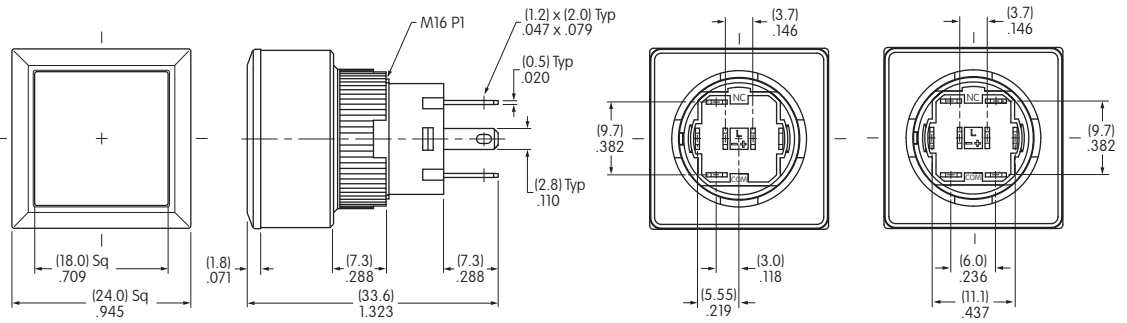

YB216CWSPW01-N-P

## PANEL THICKNESS & CUTOUT

Recommended Panel Thickness  
.020" ~ .197"  
(0.5mm ~ 5.0mm)

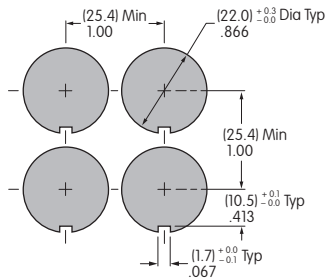

Side-by-side Mounting

Recommended Panel Thickness  
.020" ~ .197"  
(0.5mm ~ 5.0mm)

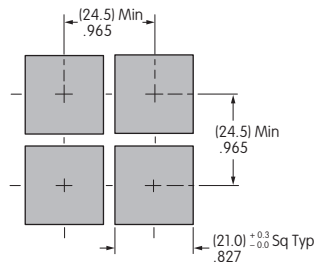

Side-by-side Mounting



OPTIONAL ACCESSORIES

Adaptors

**AT716**  
Single Pole  
Solder Lug/  
Quick Connect  
Terminals

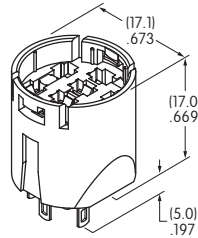
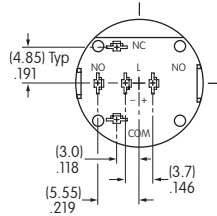

**AT717**  
Double Pole  
Solder Lug/  
Quick Connect  
Terminals

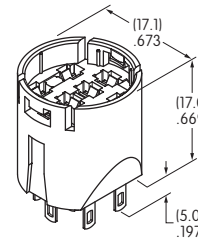
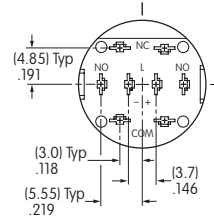

**AT718**  
Single Pole  
Straight PC  
Terminals

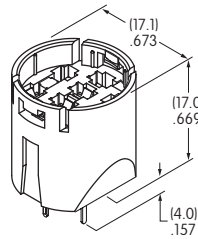
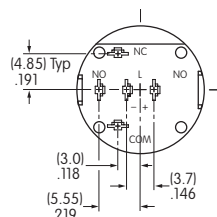

**AT719**  
Double Pole  
Straight PC  
Terminals

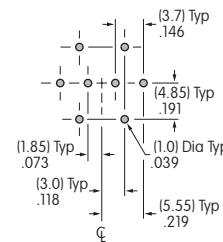
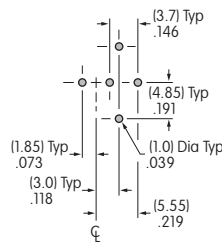
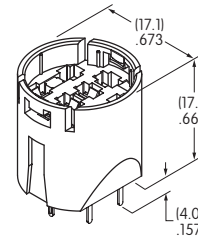
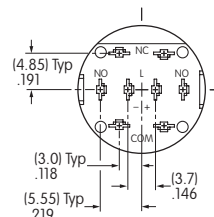

Material: Glass fiber reinforced polyamide Note: Order adaptors separately

Round & Square Switch Dimensions Shown with Adaptor AT716

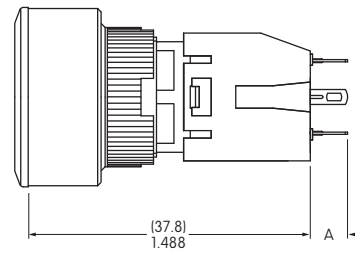
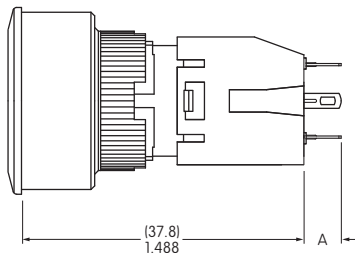

Dimension A:

Solder Lug .197" (5.0mm); Straight PC .157" (4.0mm)

Panel thickness for YB2 Round:  
.020" ~ .161" (0.5mm ~ 4.1mm)

Panel thickness for YB2 Square:  
.020" ~ .126" (0.5mm ~ 3.2mm)

## ASSEMBLY INSTRUCTIONS FOR ROUND

1. Remove knurled mounting nut.

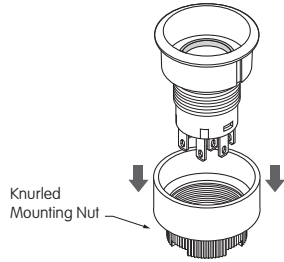

5. Install the red o-ring which was removed in step 2 at the inside bottom of the bezel.

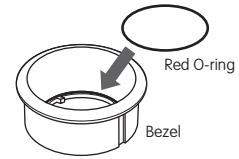

2. Remove bezel and red o-ring from housing. There are two o-rings in this assembly: one is red, one is orange.

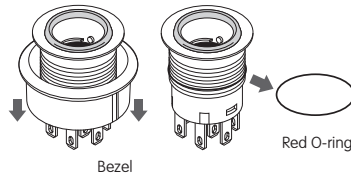

6. Align tab inside of the bezel with keyway on housing and bring bezel back into its original position.

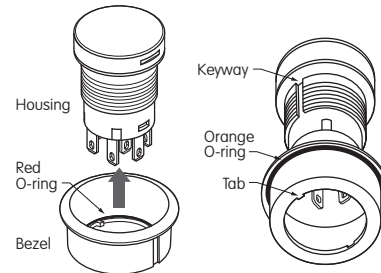

3. Install LED.

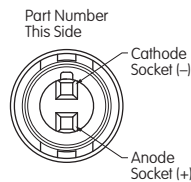

7. Before installing into panel, make sure that the orange o-ring is present at the back of the bezel. Align keyway on bezel with tab in panel and push switch all the way into the panel.

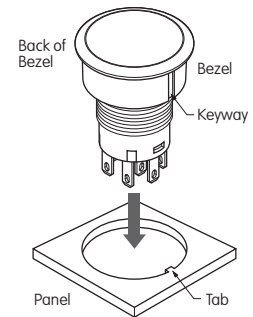

LEDs  
AT634 & AT636

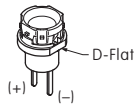

Align D-flat on LED with Part Number on switch for appropriate polarity and insert LED into base.

LED AT628

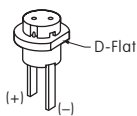

Align D-flat on LED with Part Number on switch for appropriate polarity and insert LED into base.

LEDs AT625G,  
AT631B,  
AT632F

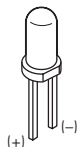

The larger metal part within the LED represents the cathode (-). Align LED for appropriate polarity and insert LED into base.

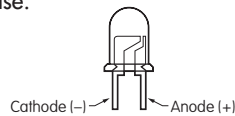

4. Align tabs (B) on both sides of actuator with the projections (A) inside of the housing and push actuator firmly down to snap in.

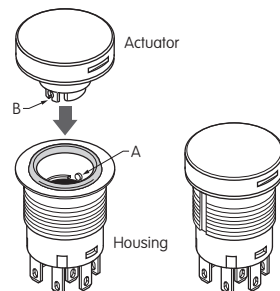

8. Attach mounting nut behind panel and tighten. Make sure that bezel and actuator fit properly and that there is no space between bezel and panel. Do not overtighten.

Mounting torque: 0.785Nm (6.95 lb•in) maximum.  
Optional socket wrench AT106 available.

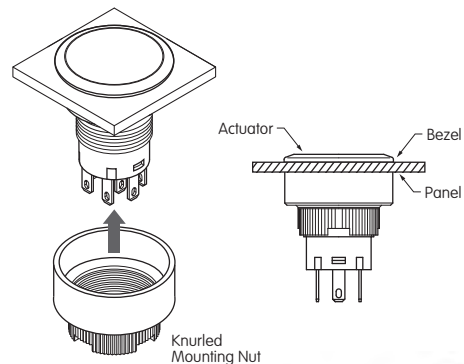

AT106 Socket Wrench



## ASSEMBLY INSTRUCTIONS FOR SQUARE

1. Remove knurled mounting nut.

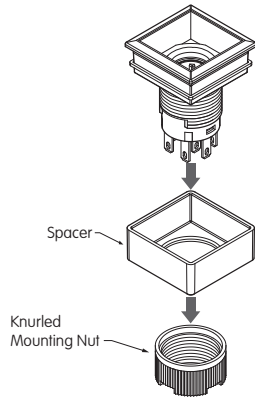

2. Remove bezel and blue o-ring from housing.

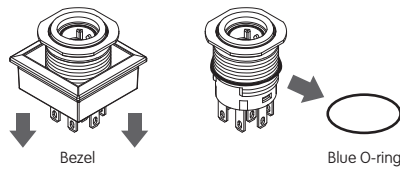

3. Install LED.

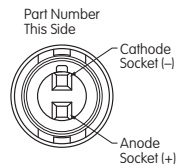

LEDs AT634 & AT636

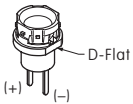

Align D-flat on LED with Part Number on switch for appropriate polarity and insert LED into base.



LED AT628

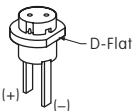

Align D-flat on LED with Part Number on switch for appropriate polarity and insert LED into base.



LEDs AT625G, AT631B, AT632F

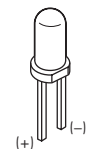

The larger metal part within the LED represents the cathode (-). Align LED for appropriate polarity and insert LED into base.

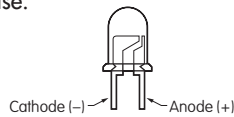

4. Align tabs (B) on both sides of actuator with the projections (A) inside of the housing and push actuator firmly down to snap in.

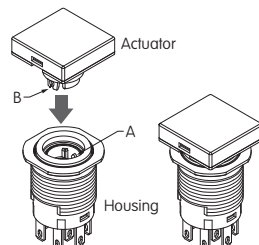

5. Install the blue o-ring which was removed in step 2 at the inside bottom of the bezel.

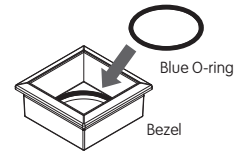

6. Align tab inside of the bezel with keyway on housing and bring bezel back into its original position.

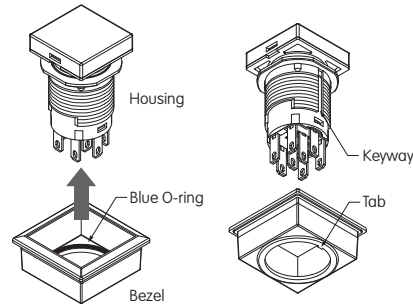

7. Before installing into panel, make sure that the square gasket is present at the back of the bezel. Align keyway on bezel with tab in panel and push switch all the way into the panel.

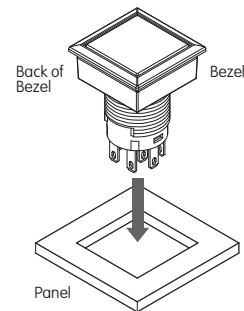

8. Attach mounting nut behind panel and tighten. Make sure that bezel and actuator fit properly and that there is no space between bezel and panel. Do not overtighten.

Mounting torque: 0.785Nm (6.95 lb•in) maximum. Optional socket wrench AT106 available.

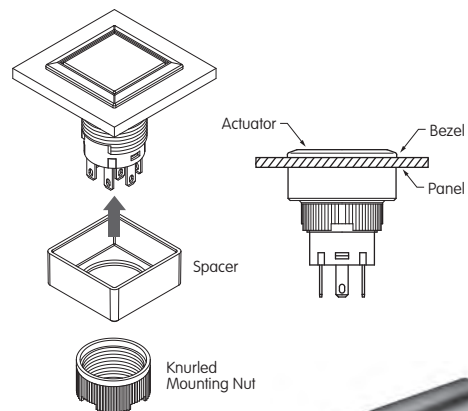

AT106 Socket Wrench



## LEGENDS

NKK Switches can provide custom legends for caps. Contact factory for more information.

### Suggested Printable Area for YB2 Caps

**Recommended Methods:** Laser Etch on clear cap, Screen Print or Pad Print on cap.  
Epoxy based ink is recommended.

For Caps  
AT3017, AT3018, and AT3019

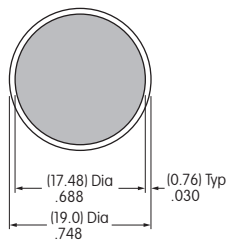

For Cap  
AT3020 (with clear ring for illumination)

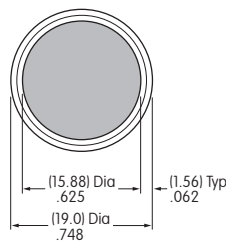

For Caps  
AT3025 and AT3027

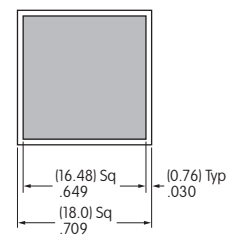

Shaded areas are printable areas.

### Suggested Printable Area for Film Inserts

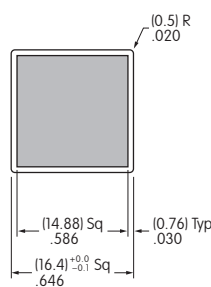
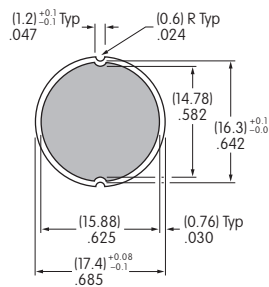

Shaded areas are printable areas.

**Recommended Method:**  
Screen Print; Epoxy based ink is recommended

**Film Material and Thickness:**  
Clear Polyester, 4 mil max.

## HANDLING & PRECAUTIONS



LEDs are electrostatic sensitive devices. When installing and handling LEDs, use an electrostatic protected work station to prevent LED damage.

**NIKK**  
SWITCHES

SmartSwitch



Toggles

Rockers

Pushbuttons

Illuminated PB

Programmable  
E

Keylocks

Rotaries

Slides

Tactiles

Tilt

Touch

Indicators

Accessories

Supplement



## OLED Pushbuttons, Display & Rocker.....E3

- Frameless OLED Switch with 96 x 64 Programmable Color Display
- OLED Switch with 64 x 48 Programmable Color Display
- OLED Display with 52 x 36 Programmable Color Display
- OLED Rocker Switch with 96 x 64 Programmable Display



## LCD 64 x 32 Pushbuttons, Display, Compact....E21

- Switch with Programmable Display; Short Travel & RGB 64 Colors
- Switch with Programmable Display; Long Travel & RGB 64 Colors
- Display: Programmable with RGB 64 Colors & Long Life LCD
- Compact Switch with Programmable Display; RGB 64 Colors



## LCD 36 x 24 Pushbuttons, Display, Compacts....E34

- Switch with Programmable Display; RGB Backlight
- Switch with Programmable Display; Red/Green Backlight
- Display: Programmable with RGB Backlight
- Compact Switch with Programmable Display; RGB Backlight
- Compact Switch with Programmable Display; Red/Green Backlight



## Accessories.....E48

Enhance Your Applications

## Development Tools & Support

NKK provides numerous development tools to get any SmartSwitch project started easily. Please visit our website or contact a sales representative.

## OLED SWITCHES & DISPLAY

### Frameless OLED Pushbutton

ISF15ACP4

96 x 64 Programmable Color Display  
Video Capability; 180° Viewing Angle  
High Definition, Excellent Contrast

Page E4



### OLED Pushbutton

ISC15ANP4

64 x 48 Programmable Color Display  
Video Capability; 180° Viewing Angle  
High Definition, Excellent Contrast

Page E8



### OLED Display

ISC01P

52 x 36 Programmable Color Display  
Video Capability; 180° Viewing Angle  
High Definition, Excellent Contrast

Page E8

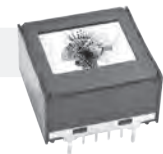

### OLED Rocker

IS18WWC1W

96 x 64 Programmable Display  
White Monochrome OLED Display  
Exceptional Contrast; 180° Viewing Angle; IP64 Rating

Page E15



### For OLED Pushbuttons & Display

Handling & Storage Page E14

### For OLED Rocker

Handling & Storage Page E20

For Controlling, refer to Application Notes on website for more information.

Toggle

Rockers

Pushbuttons

Illuminated PB

**E**  
Programmable

Key locks

Rotaries

Slides

Tactiles

Tilt

Touch

Indicators

Accessories

Supplement

### DISTINCTIVE CHARACTERISTICS

- High definition, contrast and resolution of 96RGB x 64 pixels in compact screen and minimal frame
- Range of 65,536 colors in 16 bit mode
- Operating life of 50,000 hours minimum
- Maximum use of display lens with ultra-thin frame provides full screen capacity
- Multiple units easily combine to form one screen, offering flexibility in size and layout
- Smooth, silent operation with short stroke of 0.07" lends to tactile feedback unparalleled to touch panels
- Same outer dimensions of switch and footprint, enabling ease of replacement with current switches
- Operated by commands and data supplied via serial communications (SPI)
- Incorporates bitmap display function
- Low energy consumption
- Dust tight construction
- Snap-in standoff for easy, secure mounting and alignment; aids in prevention of dislodging during wave soldering

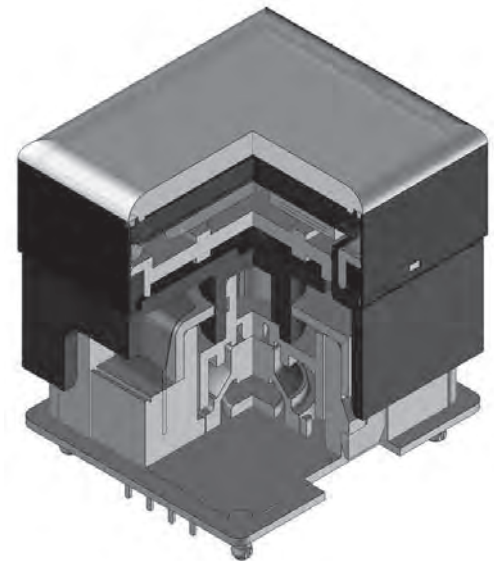

Viewing area: 21.28mm x 18.7mm (horizontal x vertical)

High reliability and long life of one million actuations minimum

Highly reliable gold plated twin contacts

Epoxy sealed straight PC terminals

Actual Size

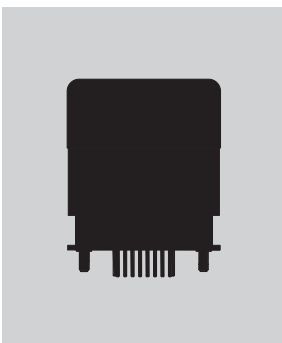





## SWITCH PART NUMBER & DESCRIPTION

Part Number	Switch Description	OLED	Pixel Format
<b>ISF15ACP4</b>	SPST, Momentary ON Gold Contacts Straight PC Terminals	Color OLED Display Module 65,536 Colors	96RGB x 64 Pixels Horizontal x Vertical

## SWITCH SPECIFICATIONS

<b>Circuit</b>	SPST normally open
<b>Contact Position</b>	Leave actuator: ① - ② OFF Push actuator: ① - ② ON
<b>Electrical Capacity (Resistive Load)</b>	100mA @ 12V DC (resistive circuit)
<b>Contact Resistance</b>	200 milliohms maximum @ 20mV 10mA
<b>Insulation Resistance</b>	100 megohms minimum @ 100V DC
<b>Dielectric Strength</b>	125V AC for 1 minute minimum
<b>Mechanical Endurance</b>	1,000,000 operations minimum
<b>Electrical Endurance</b>	1,000,000 operations minimum
<b>Operating Force</b>	2.0 ± 0.5 Newtons
<b>Total Travel</b>	1.8mm (0.07")

## OLED SPECIFICATIONS

### Characteristics of Display

<b>Display Device</b>	Color OLED display module
<b>Display Mode</b>	Passive matrix
<b>Viewing Area</b>	21.28mm x 18.74mm (horizontal x vertical)
<b>Pixel Format</b>	96RGB x 64 pixels (horizontal x vertical)
<b>Pixel Size</b>	0.222mm x 0.293mm (horizontal x vertical)
<b>Interface</b>	Serial (SPI) interface
<b>Number of Colors</b>	65,536 Colors (16bit: R 5bit/G 6bit/B 5bit) or 256 Colors (8bit: R 2bit/G 3bit/B 3bit)
<b>Operating Temperature Range</b>	-20°C ~ +70°C (-4°F ~ +158°F)
<b>Storage Temperature Range</b>	-30°C ~ +80°C (-22°F ~ +176°F)
<b>Operating Life (Display)</b>	50,000 hours @ 100cd/m <sup>2</sup> (based on 40% pixels ON; Ta = 77°F)

### Absolute Maximum Ratings

Items	Symbols	Ratings
Supply Voltage for Logic/Interface	V <sub>DD</sub>	-0.3V to +4.0V
Supply Voltage for Drive	V <sub>CC</sub>	-0.0V to +19.0V
Input Voltage	V <sub>I</sub>	-0.3V to V <sub>DD</sub> +0.3V

### Current Consumption

(Temperature at 25°C, V<sub>DD</sub> = 2.8V, V<sub>CC</sub> = 15.0V)

Items	Symbols	Min	Typical	Max
All-Pixels-On Mode *Drive System Power Current	I <sub>CC1</sub>	—	11.0mA	13.2mA
All-Pixels-On Mode *Logic/IF System Power Current	I <sub>DD1</sub>	—	0.17mA	0.20mA
Sleep Mode **Drive System Power Current	I <sub>CC2</sub>	—	—	10μA
Sleep Mode **Logic/IF System Power Current	I <sub>DD2</sub>	—	—	10μA

\* All pixels shall be turned on with the maximum level gray scale

\*\* All pixels shall be turned off (while chip is operating)

### Recommended Operating Conditions

Items	Symbols	Minimum	Typical	Maximum
Supply Voltage for Logic/Interface	V <sub>DD</sub>	2.4V	2.8V	3.5V
Supply Voltage for Drive	V <sub>CC</sub>	14.0V	15.0V	16.0V
Input High Level Voltage	V <sub>IH</sub>	0.8 x V <sub>DD</sub>	—	—
Input Low Level Voltage	V <sub>IL</sub>	—	—	0.2 x V <sub>DD</sub>

### Optical Characteristics (Temperature at 25°C, Initial Value: 87 x 0F)

Items	Min	Typical	Max	Unit	Remarks
Luminosity	80	105	130	cd/m <sup>2</sup>	White (All pixels on)
White Color Coordinate	(x)	0.26	0.30	0.34	—
	(y)	0.31	0.36	0.41	—
Red Color Coordinate	(x)	0.62	0.66	0.70	—
	(y)	0.30	0.34	0.38	—
Green Color Coordinate	(x)	0.24	0.29	0.33	—
	(y)	0.59	0.63	0.67	—
Blue Color Coordinate	(x)	0.10	0.15	0.19	—
	(y)	0.10	0.17	0.23	—
Contrast Ratio	100	—	—	—	—

### BLOCK DIAGRAM & PIN CONFIGURATIONS



ISF15ACP4

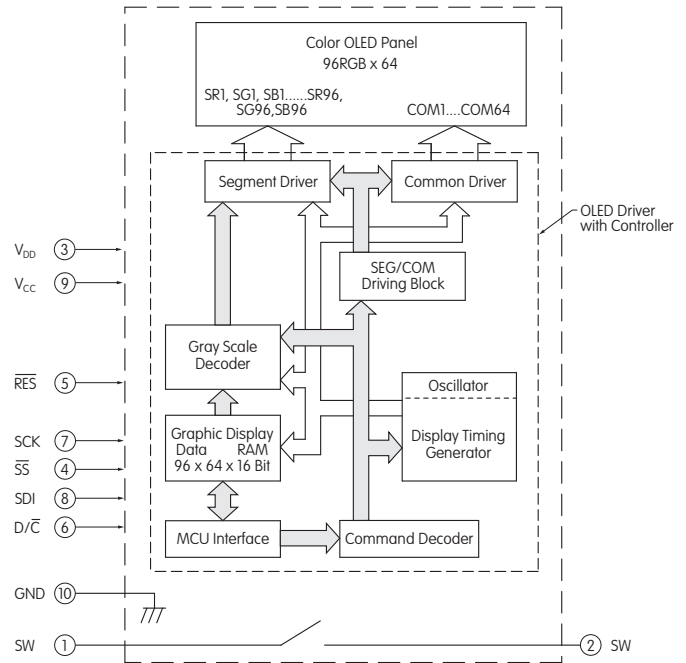

Pin No.	Symbol	Name	Function
①	SW	Terminal of Switch	Normally open
②	SW	Terminal of Switch	Normally open
③	V <sub>DD</sub>	Power	Power source for logic circuit
④	SS	Slave Select	Slave select for SPI. This line is active low.
⑤	RES	Reset	Reset signal input. When pin is low, initialization of chip is executed.
⑥	D/C	Data/Command	Data/Command Control. When pin is pulled low, data will be interpreted as Command; when pulled high, data will be interpreted as Data.
⑦	SCK	Serial Clock	Clock line for SPI that synchronizes command and data
⑧	SDI	Serial Data In	Data input line for SPI
⑨	V <sub>CC</sub>	Power	Power source for drive circuit
⑩	GND	Ground	Connect to Ground

### TYPICAL SWITCH DIMENSIONS

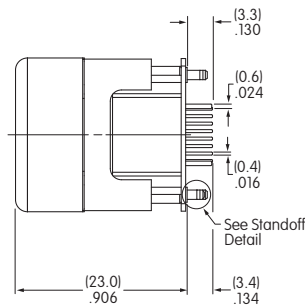
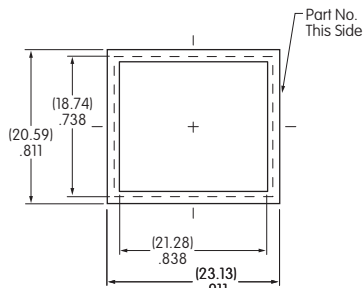

Terminal numbers are not on the switch.

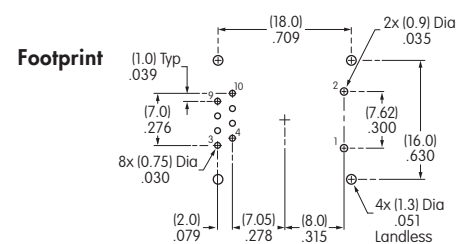
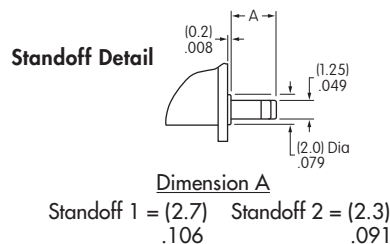
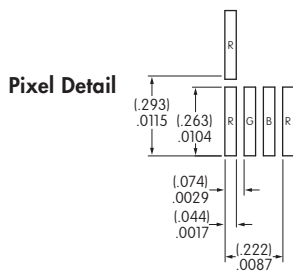
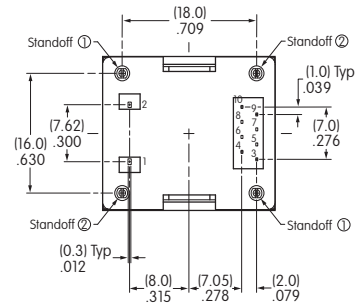

## TIMING SPECIFICATIONS

**AC Characteristics** (Temperature at 25°C),  $V_{DD} = 2.4V \sim 3.5V$

Items	Symbols	Minimum	Typical	Maximum
Clock Cycle Time	$t_{cycle}$	150ns	—	—
D/ $\bar{C}$ Setup Time	$t_{AS}$	40ns	—	—
D/ $\bar{C}$ Hold Time	$t_{AH}$	40ns	—	—
$\bar{SS}$ Setup Time	$t_{CSS}$	75ns	—	—
$\bar{SS}$ Hold Time	$t_{CSH}$	60ns	—	—
Write Data Setup Time	$t_{DSW}$	40ns	—	—
Write Data Hold Time	$t_{DHW}$	40ns	—	—
SCK Low Time	$t_{CLKL}$	75ns	—	—
SCK High Time	$t_{CLKH}$	75ns	—	—
SCK Rise Time	$t_R$	—	—	15ns
SCK Fall Time	$t_F$	—	—	15ns

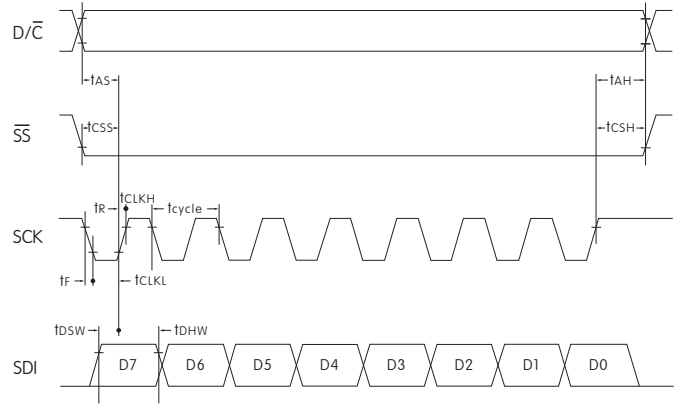

## STATE TRANSITION

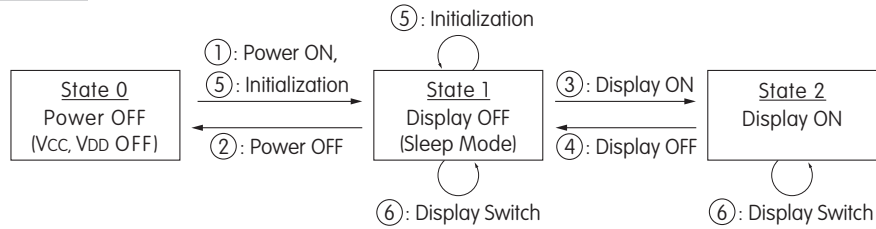

State Number	State	Display	Sleep	$V_{CC}$	$V_{DD}$	Changing the Display
0	Power OFF	OFF	—	OFF	OFF	Disable
1	Display OFF	OFF	ON	ON	ON	Enable
2	Display ON	ON	OFF	ON	ON	Enable

State Transition	Transition	Index
①	Power ON	Refer to "Power ON/OFF Sequence"
②	Power OFF	
③	Display ON	
④	Display OFF	
⑤	Initialization	Initialize Setting of Command/Data
⑥	Image Rewriting	Send Display Data
	Display Settings	Dimmer, Scroll, etc.

## Power ON/OFF Sequence

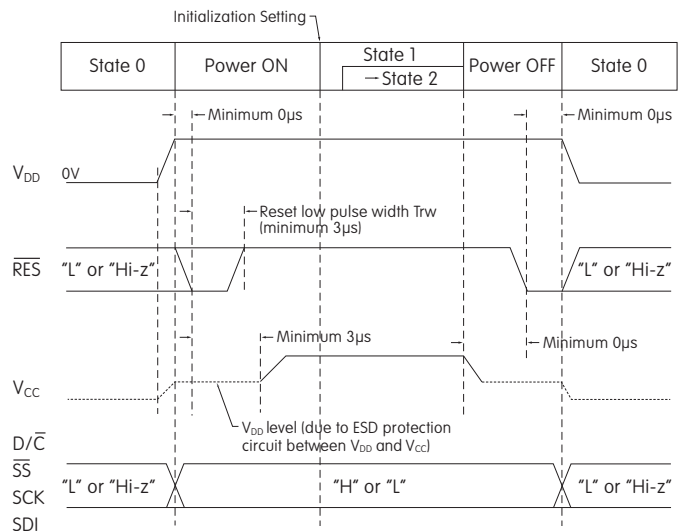

### DISTINCTIVE CHARACTERISTICS

- Organic LED technology
- Life 30,000 hours @ 100cd/m<sup>2</sup> (based on 40% pixels on) or 60,000 hours @ 50cd/m<sup>2</sup> (based on 40% pixels on)
- Power consumption only 3.8mA (30% less than previous product)
- Range of 65,536 colors in 16 bit mode, 256 colors in 8 bit mode
- Full viewing angle of 180°
- Exceptional contrast: 50 times greater than LCD products
- Four times more enhanced resolution
- High resolution provides sharp, clear images of very small characters
- Operated by commands and data supplied via serial communications (SPI)
- Distinct, long travel of 4.5mm (same as KP01 series pushbuttons)
- Dust tight construction
- Stylish, translucent black housing design

Viewing area: 15.5mm x 11.6mm (horizontal x vertical)

High reliability and long life of three million actuations minimum

High resolution of 64RGB x 48 pixels

Epoxy sealed straight PC terminals

Snap-in standoff for easy, secure mounting and alignment

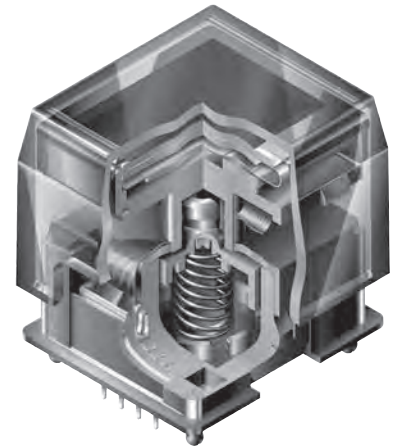

Viewing area: 12.9mm x 9.9mm (horizontal x vertical)

High resolution of 52RGB x 36 pixels

Bracket has crimped legs to ensure secure PC mounting and prevent dislodging during wave soldering

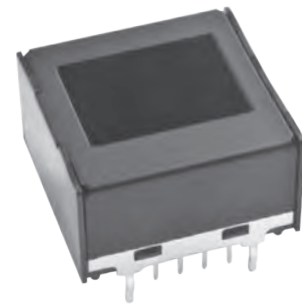

Actual Sizes

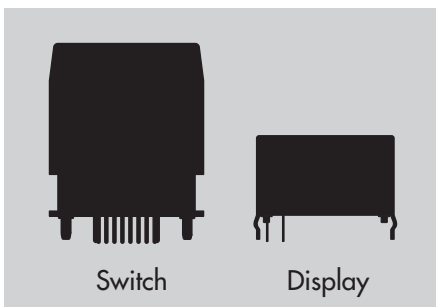



## SWITCH PART NUMBER & DESCRIPTION

Part Number	Switch Description	OLED	Pixel Format
<b>ISC15ANP4</b>	SPST, Momentary ON Gold Contacts Straight PC Terminals	Color OLED Display Module 65,536 Colors	64RGB x 48 Pixels Horizontal x Vertical

## SWITCH SPECIFICATIONS

Circuit	SPST normally open
Contact Position	Leave actuator: ① - ② OFF Push actuator: ① - ② ON
Electrical Capacity (Resistive Load)	100mA @ 12V DC
Contact Resistance	200 milliohms maximum @ 20mV 10mA
Insulation Resistance	100 megohms minimum @ 100V DC
Dielectric Strength	125V AC for 1 minute minimum
Mechanical Endurance	3,000,000 operations minimum
Electrical Endurance	3,000,000 operations minimum
Operating Force	2.0 ± 0.5 Newtons
Total Travel	4.5mm (.177")

## OLED SPECIFICATIONS

### Characteristics of Display

Display Device	Color OLED display module
Display Mode	Passive matrix
Viewing Area	15.5mm x 11.6mm (horizontal x vertical)
Pixel Format	64RGB x 48 pixels (horizontal x vertical)
Pixel Size	0.21mm x 0.20mm (horizontal x vertical)
Interface	Serial (SPI) interface
Number of Colors	65,536 Colors (16bit: R 5bit/G 6bit/B 5bit) or 256 Colors (8bit: R 2bit/G 3bit/B 3bit)
Operating Temperature Range	-20°C ~ +70°C (-4°F ~ +158°F)
Storage Temperature Range	-30°C ~ +80°C (-22°F ~ +176°F)
Operating Life (Display)	30,000 hours @ 100cd/m <sup>2</sup> (based on 40% pixels ON) 60,000 hours @ 50cd/m <sup>2</sup> (based on 40% pixels ON)

### Absolute Maximum Ratings

Items	Symbols	Ratings
Supply Voltage for Logic/Interface	V <sub>DD</sub>	-0.3V to +4.0V
Supply Voltage for Drive	V <sub>CC</sub>	-0.0V to +19.0V
Input Voltage	V <sub>I</sub>	-0.3V to V <sub>DD</sub> +0.3V

### Current Consumption

(Temperature at 25°C, V<sub>DD</sub> = 2.8V, V<sub>CC</sub> = 16.0V)

Items	Symbols	Min	Typical	Max
All-Pixels-On Mode *Drive System Power Current	I <sub>CC1</sub>	—	3.8mA	4.6mA
All-Pixels-On Mode *Logic/IF System Power Current	I <sub>DD1</sub>	—	0.16mA	0.19mA
Sleep Mode **Drive System Power Current	I <sub>CC2</sub>	—	—	10µA
Sleep Mode **Logic/IF System Power Current	I <sub>DD2</sub>	—	—	10µA

\* All pixels shall be turned on with the maximum level gray scale

\*\* All pixels shall be turned off (while chip is operating)

### Recommended Operating Conditions

Items	Symbols	Minimum	Typical	Maximum
Supply Voltage for Logic/Interface	V <sub>DD</sub>	2.4V	2.8V	3.5V
Supply Voltage for Drive	V <sub>CC</sub>	15.0V	16.0V	17.0V
Input High Level Voltage	V <sub>IH</sub>	0.8 x V <sub>DD</sub>	—	—
Input Low Level Voltage	V <sub>IL</sub>	—	—	0.2 x V <sub>DD</sub>

### Optical Characteristics (Temperature at 25°C, Initial Value: 87 x 0F)

Items	Min	Typical	Max	Unit	Remarks
Luminosity	75	100	125	cd/m <sup>2</sup>	White (All pixels on)
White Color Coordinate	(x)	0.26	0.30	0.34	—
	(y)	0.32	0.37	0.42	—
Red Color Coordinate	(x)	0.63	0.67	0.71	—
	(y)	0.29	0.33	0.37	—
Green Color Coordinate	(x)	0.19	0.23	0.27	—
	(y)	0.61	0.65	0.69	—
Blue Color Coordinate	(x)	0.10	0.14	0.18	—
	(y)	0.14	0.20	0.26	—
Contrast Ratio	100	—	—	—	—

## SWITCH BLOCK DIAGRAM & PIN CONFIGURATIONS



ISC15ANP4

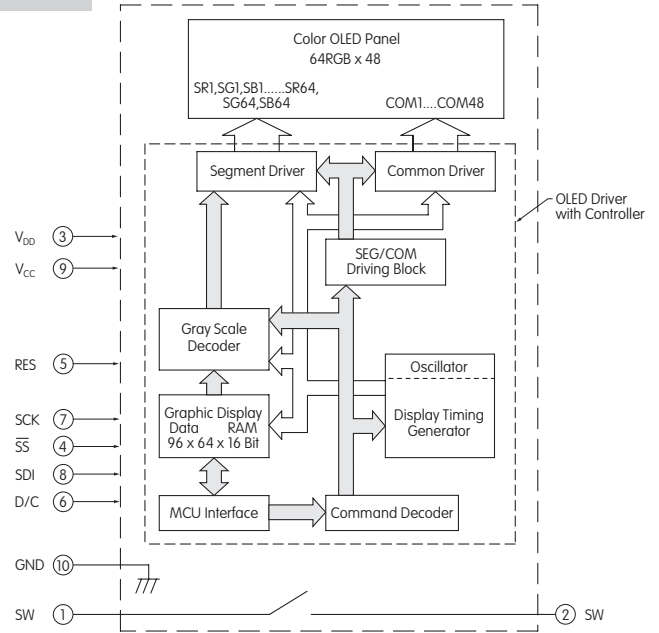

Pin No.	Symbol	Name	Function
①	SW	Terminal of Switch	Normally open
②	SW	Terminal of Switch	Normally open
③	V <sub>DD</sub>	Power	Power source for logic circuit
④	SS	Slave Select	Slave select for SPI. This line is active low.
⑤	RES	Reset	Reset signal input. When pin is low, initialization of chip is executed.
⑥	D/C	Data/Command	Data/Command Control. When pin is pulled low, data will be interpreted as Command; when pulled high, data will be interpreted as Data.
⑦	SCK	Serial Clock	Clock line for SPI that synchronizes command and data
⑧	SDI	Serial Data In	Data input line for SPI
⑨	V <sub>CC</sub>	Power	Power source for drive circuit
⑩	GND	Ground	Connect to Ground

## TYPICAL SWITCH DIMENSIONS

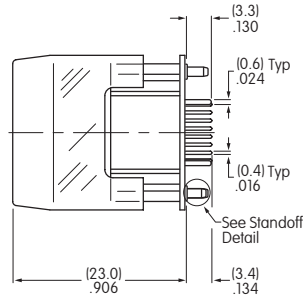
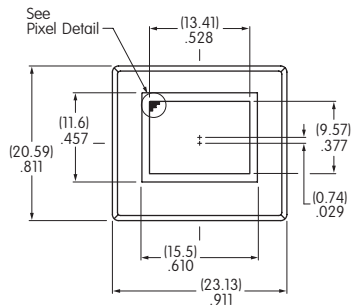

Terminal numbers are not on the switch.

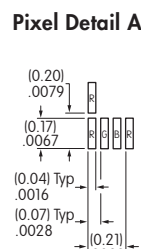
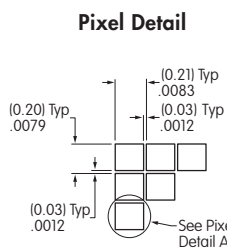
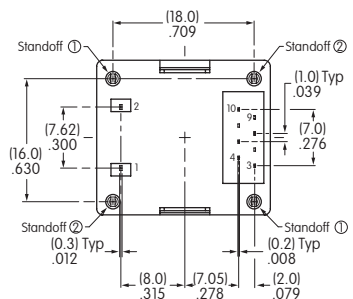

### Standoff Detail

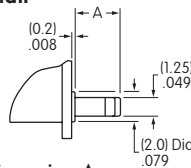

Dimension A  
Standoff 1 = (2.7) / .106  
Standoff 2 = (2.3) / .091

### Footprint

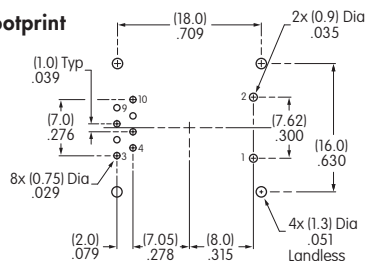

## DISPLAY PART NUMBER & DESCRIPTION



Part Number	Display Description	OLED	Pixel Format
<b>ISC01P</b>	Straight PC Terminals	Color OLED Display Module 65,536 Colors	52RGB x 36 Pixels Horizontal x Vertical

## OLED SPECIFICATIONS

### Characteristics of Display

Display Device	Color OLED display module
Display Mode	Passive matrix
Viewing Area	12.9mm x 9.9mm (horizontal x vertical)
Pixel Format	52RGB x 36 pixels (horizontal x vertical)
Pixel Size	0.21mm x 0.22mm (horizontal x vertical)
Interface	Serial (SPI) interface
Number of Colors	65,536 Colors (16bit: R 5bit/G 6bit/B 5bit) or 256 Colors (8bit: R 2bit/G 3bit/B 3bit)
Operating Temperature Range	-20°C ~ +70°C (-4°F ~ +158°F)
Storage Temperature Range	-30°C ~ +80°C (-22°F ~ +176°F)
Operating Life (Display)	30,000 hours @ 100cd/m <sup>2</sup> (based on 40% pixels ON) 60,000 hours @ 50cd/m <sup>2</sup> (based on 40% pixels ON)

### Absolute Maximum Ratings

Items	Symbols	Ratings
Supply Voltage for Logic/Interface	V <sub>DD</sub>	-0.3V to +4.0V
Supply Voltage for Drive	V <sub>CC</sub>	0.0V to +19.0V
Input Voltage	V <sub>I</sub>	-0.3V to V <sub>DD</sub> +0.3V

### Current Consumption

(Temperature at 25°C, V<sub>DD</sub> = 2.8V, V<sub>CC</sub> = 16.0V)

Items	Symbols	Min	Typical	Max
All-Pixels-On Mode *Drive System Power Current	I <sub>CC1</sub>	—	2.4mA	2.9mA
All-Pixels-On Mode *Logic/IF System Power Current	I <sub>DD1</sub>	—	0.15mA	0.18mA
Sleep Mode **Drive System Power Current	I <sub>CC2</sub>	—	—	10μA
Sleep Mode **Logic/IF System Power Current	I <sub>DD2</sub>	—	—	10μA

\*All pixels shall be turned on with the maximum level gray scale

\*\*All pixels shall be turned off (while chip is operating)

### Recommended Operating Conditions

Items	Symbols	Minimum	Typical	Maximum
Supply Voltage for Logic/Interface	V <sub>DD</sub>	2.4V	2.8V	3.5V
Supply Voltage for Drive	V <sub>CC</sub>	15.0V	16.0V	17.0V
Input High Level Voltage	V <sub>IH</sub>	0.8 x V <sub>DD</sub>	—	—
Input Low Level Voltage	V <sub>IL</sub>	—	—	0.2 x V <sub>DD</sub>

### Optical Characteristics (Temperature at 25°C, Initial Value: 87 x 0F)

Items	Min	Typical	Max	Unit	Remarks
Luminosity	75	100	125	cd/m <sup>2</sup>	White (All pixels on)
White Color Coordinate	(x)	0.25	0.29	0.33	—
	(y)	0.31	0.36	0.41	—
Red Color Coordinate	(x)	0.63	0.67	0.71	—
	(y)	0.29	0.33	0.37	—
Green Color Coordinate	(x)	0.19	0.23	0.27	—
	(y)	0.60	0.64	0.68	—
Blue Color Coordinate	(x)	0.10	0.14	0.18	—
	(y)	0.14	0.20	0.26	—
Contrast Ratio	100	—	—	—	—

## DISPLAY BLOCK DIAGRAM & PIN CONFIGURATIONS



**ISCO1P**

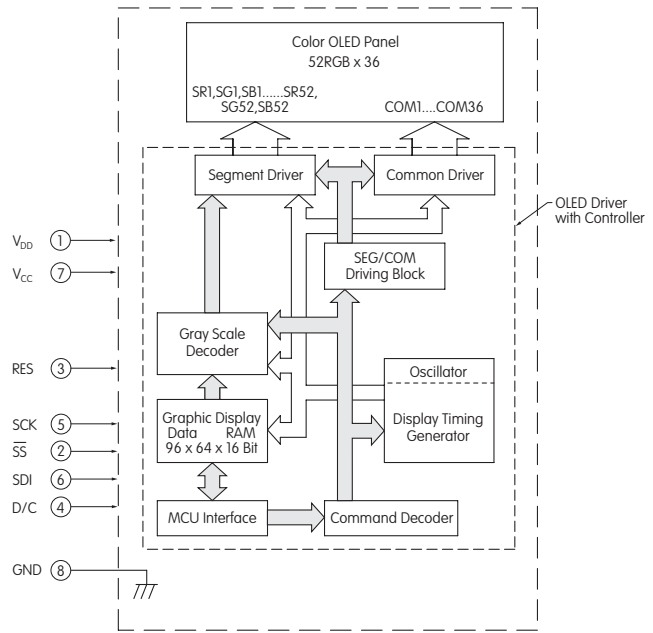

Pin No.	Symbol	Name	Function
①	V <sub>DD</sub>	Power	Power source for logic circuit
②	SS	Slave Select	Slave select for SPI. This line is active low.
③	RES	Reset	Reset signal input. When pin is low, initialization of chip is executed.
④	D/C	Data/Command	Data/Command Control. When pin is pulled low, data will be interpreted as Command; when pulled high, data will be interpreted as Data.
⑤	SCK	Serial Clock	Clock line for SPI that synchronizes command and data
⑥	SDI	Serial Data In	Data input line for SPI
⑦	V <sub>CC</sub>	Power	Power source for drive circuit
⑧	GND	Ground	Connect to Ground

## TYPICAL DISPLAY DIMENSIONS

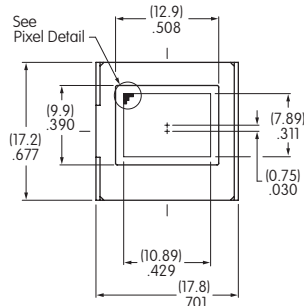

**Pixel Detail**

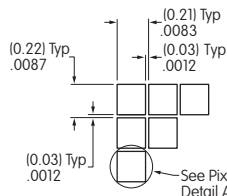

**Pixel Detail A**

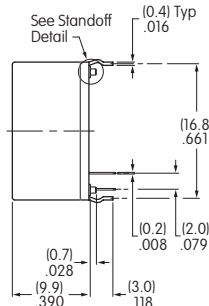
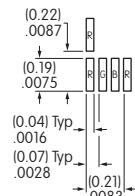

**Standoff Detail**

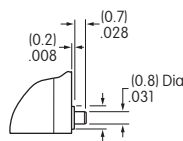

Terminal numbers are not on the switch.

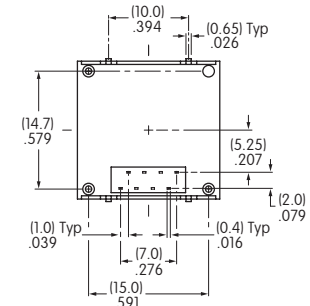

**Footprint**

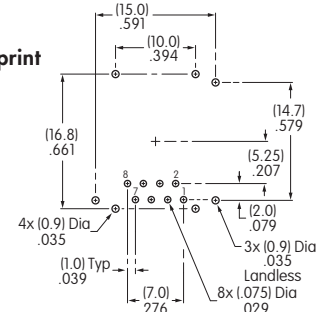



## TIMING SPECIFICATIONS FOR SWITCH & DISPLAY

**AC Characteristics** (Temperature at 25°C),  $V_{DD} = 2.4V \sim 3.5V$

Items	Symbols	Minimum	Typical	Maximum
Clock Cycle Time	$t_{cycle}$	150ns	—	—
D/C Setup Time	$t_{AS}$	40ns	—	—
D/C Hold Time	$t_{AH}$	40ns	—	—
$\overline{SS}$ Setup Time	$t_{CSS}$	75ns	—	—
$\overline{SS}$ Hold Time	$t_{CSH}$	60ns	—	—
Write Data Setup Time	$t_{DSW}$	40ns	—	—
Write Data Hold Time	$t_{DHW}$	40ns	—	—
SCK Low Time	$t_{CLKL}$	75ns	—	—
SCK High Time	$t_{CLKH}$	75ns	—	—
SCK Rise Time	$t_R$	—	—	15ns
SCK Fall Time	$t_F$	—	—	15ns

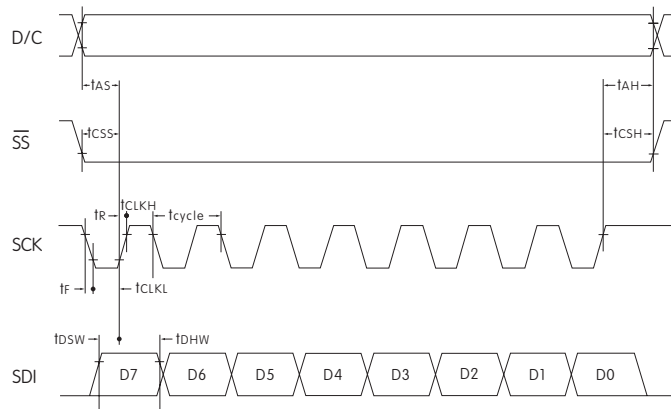

## STATE TRANSITION

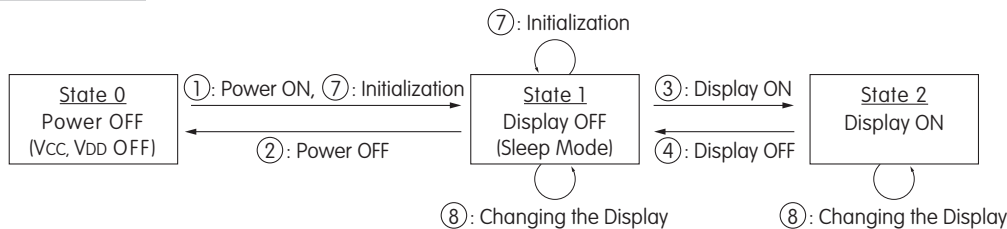

State Number	State	Display	Sleep	$V_{CC}$	$V_{DD}$	Changing the Display
0	Power OFF	OFF	—	OFF	OFF	Disable
1	Display OFF	OFF	ON	ON	ON	Enable
2	Display ON	ON	OFF	ON	ON	Enable

State Transition	Transition	Index
①	Power ON	Refer to "Power ON/OFF Sequence"
②	Power OFF	
③	Display ON	
④	Display OFF	
⑦	Initialization	Initialize Setting of Command/Data
⑧	Image Rewriting	Send Display Data
	Display Settings	Dimmer, Scroll, etc.

## Power ON/OFF Sequence

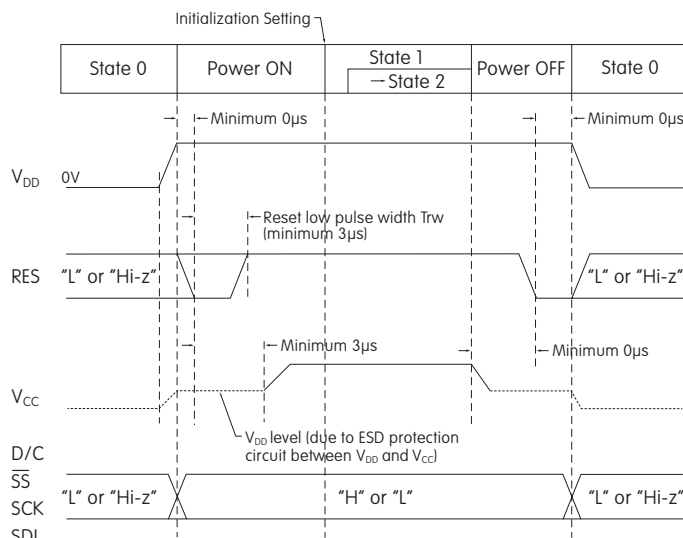

Note: Refer to Application Notes on web site.

### PRECAUTIONS FOR HANDLING & STORAGE OF OLED PUSHBUTTONS & DISPLAY

#### Handling



1. The IS Series OLED devices are electrostatic sensitive. To avoid damage to IC, do not touch terminals unless properly isolated from static electricity.
2. Signal input under conditions not recommended may cause damage to the OLED unit or deterioration of the display. Follow directions regarding supply sequences of power and signal voltages.
3. If the OLED panel is broken, avoid touching the contents. Wash off any contact to the skin or clothing.
4. Limit operating force to switch keytop to 100.0N maximum, as excessive pressure may damage the OLED.
5. For OLED display, it is necessary for bracket legs to be Grounded.
6. Recommended soldering time and temperature limits for OLED switch or display:  
 Avoid temperatures exceeding 80°C at the OLED.  
 Wave Soldering: see Profile A in Supplement section.  
 Manual Soldering: see Profile A in Supplement section.
7. The IS series OLED devices are not process sealed.
8. Pixels acquire diminished brightness over time and use, and those most frequently habituated have greater reduction of brightness than those less used. To minimize this difference, operate OLED unit so that all pixels are used as consistently as possible.
9. For switch, clean cap surface with dry cloth. If further cleaning is needed, wipe with dampened cloth using neutral cleanser and dry with clean cloth. Do not use organic solvent. For display, avoid contact with any flux or detergent. If any liquids spill on display surface, immediately wipe with soft absorbent cloth.
10. Proper serial resistors and buffers for signals should be used to prevent noise problems.

#### Storage

1. Store in original container and away from direct sunlight.
2. Keep away from static electricity.
3. Avoid extreme temperatures, high humidity, gaseous substances, and all forms of chemical contamination.

**DISTINCTIVE CHARACTERISTICS**

- Organic LED technology in display rocker (patent pending)
- Multifunction programmable device: select with rocker, push for activation
- Replaces multiple switches and displays with one device in a small package
- Broad display aids in navigation, both forward and reverse and up and down, in structured menus
- Wide viewing angle of 180° and large 0.92" display with exceptional contrast
- Conforms to IP64 of IEC60529 Standards on panel surface; dust tight construction of switch prevents entry of dust and improves contact reliability
- Commands and data supplied via serial communications protocol (SPI)
- Long life OLED with 52,000 hours at 30% illumination
- High reliability and long mechanical and electrical life of one million actuations minimum
- Stylish black housing design with matte finish complements any application

Monochrome OLED featuring sharp contrast and high resolution with 96 x 64 pixels

Panel mount with easy, snap-in installation

Short 14.6mm (.575") behind-panel height for compact spaces

Actual Size

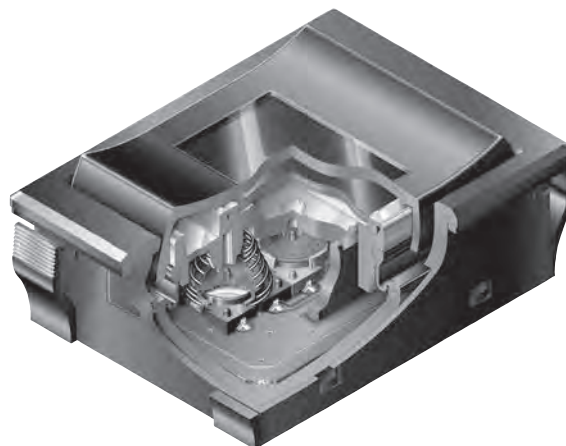
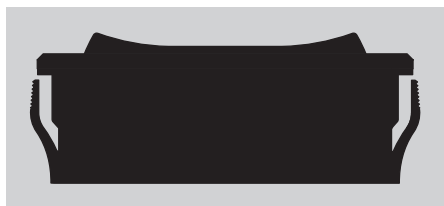

**SMARTSWITCH PART NUMBER & DESCRIPTION**

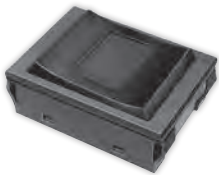
Part Number	Description
<p><b>IS18WWC1W</b></p>	<p><b>OLED Rocker Switch:</b> SP3T Switch                      Rocker (ON) (ON) (ON)                      Pushbutton Normally OFF</p> 

Supplement

Accessories

Indicators

Touch

Tilt

Tactiles

Slides

Rotaries

Key locks

Programmable

Illuminated PB

Pushbuttons

Rockers

Toggles

## SWITCH SPECIFICATIONS

Circuit	Single Pole Three Throw (Momentary)					
Contact Position	Top		Center		Bottom	
	Normal OFF	Down (ON) 9-12	Normal OFF	Down (ON) 10-12	Normal OFF	Down (ON) 11-12
Electrical Capacity (Resistive Load)	3VA maximum DC					
Contact Resistance	200 milliohms maximum					
Insulation Resistance	500 megohms minimum @ 250V DC					
Dielectric Strength	250V AC for 1 minute minimum					
Electrostatic Resisting Pressure	15kV minimum					
Mechanical Endurance	1,000,000 operations minimum					
Electrical Endurance	1,000,000 operations minimum					
Operating Force	5±2 Newtons at center of cap; 3.7±1.7 Newtons at top and bottom					
Total Travel	1.3±0.5mm (.051"±.020") at center of cap; 1.8±0.6mm (.71"±.024") at top and bottom					

## OLED SPECIFICATIONS

### Characteristics of Display

Display Device	Single color OLED display
Display Mode	Passive matrix
Pixel Format	96 x 64 pixels (horizontal x vertical)
Pixel Size	0.16mm x 0.177mm (horizontal x vertical)
Interface	Serial (SPI) interface
Color	White/Black (normally White)
Splash & Dust Proof	Conforms to IP64 of IEC60529 standards on panel surface
Operating Temperature Range	-20°C ~ +70°C (-4°F ~ +158°F)
Storage Temperature Range	-25°C ~ +80°C (-13°F ~ +176°F)
Operating Life Time (Display)	52,000 hours (30% brightness); 15,600 hours (100% brightness)

### Absolute Maximum Ratings (Temperature at 25°C)

Items	Symbols	Ratings
Supply Voltage for Logic/Interface	VDDA	-0.3V to +3.6V
Supply Voltage for Drive	VAH	-0.3V to +18.0V
Input Voltage	V <sub>in</sub>	-0.3V to VDDA +0.3V

### Current Consumption

(Temperature at 25°C, VDDA = 2.8V, VAH = 15.0V)

Items	Symbols	Min	Typical	Max
All-Pixels-On Mode *Drive System Power Current	I <sub>H1</sub>	—	11.0mA	13.2mA
All-Pixels-On Mode *Logic/IF System Power Current	I <sub>DD1</sub>	—	0.58mA	0.72mA
Sleep Mode **Drive System Power Current	I <sub>H2</sub>	—	—	10µA
Sleep Mode **Logic/IF System Power Current	I <sub>DD2</sub>	—	—	10µA

\* All pixels shall be turned on with the maximum level gray scale  
 \*\* All pixels shall be turned off (while chip is operating)

### Recommended Operating Conditions

Items	Symbols	Minimum	Typical	Maximum
Supply Voltage for Logic/Interface	VDDA	2.7V	2.8V	2.9V
Supply Voltage for Drive	VAH	14.5V	15.0V	15.5V
Input High Level Voltage	V <sub>IH</sub>	0.75 x VDDA	—	VDDA
Input Low Level Voltage	V <sub>IL</sub>	0.0	—	0.25V x VDDA

### Optical Characteristics

(Temperature at 25°C, Initial Value: depends on initial setting)

Items	Minimum	Typical	Maximum
Brightness	75 cd/m <sup>2</sup>	100 cd/m <sup>2</sup>	125 cd/m <sup>2</sup>
Chromaticity	(x)	*1	*1
	(y)	*1	*1
Contrast	100	—	—

\* Chromaticity range is the area of the ellipse. (See Chromaticity Diagram next page) The ellipse passes through points A, B, C and D and designates the center of each side of the quadrangle.

## Chromaticity Diagram

Point	Chromaticity X	Chromaticity Y
A	0.3441	0.3663
B	0.2983	0.3384
C	0.2799	0.2881
D	0.3257	0.3160

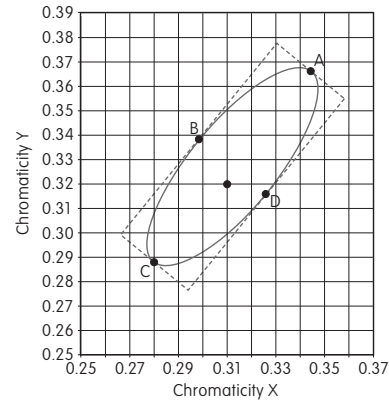

## TIMING SPECIFICATIONS

### AC Characteristics

(Temperature at  $-20^{\circ}\text{C} \sim +70^{\circ}\text{C}$ ),  $V_{\text{DDA}} = 2.8\text{V}$ ,  $V_{\text{AH}} = 16\text{V}$

Items	Symbols	Minimum	Typical	Maximum
Clock Cycle Time	$t_{\text{cycle}}$	100ns	—	—
A0 Setup Time	$t_{\text{SWDS}}$	65ns	—	—
A0 Hold Time	$t_{\text{SWDH}}$	35ns	—	—
$\overline{\text{XCS}}$ Setup Time	$t_{\text{CWS}}$	65ns	—	—
$\overline{\text{XCS}}$ Hold Time	$t_{\text{CWH}}$	95ns	—	—
High Level $\overline{\text{XCS}}$ Pulse Width	$t_{\text{CSBH}}$	*10ns	—	—
Write Data Setup Time	$t_{\text{WDTS}}$	10ns	—	—
Write Data Hold Time	$t_{\text{WDTH}}$	20ns	—	—
SCL Low Time	$t_{\text{SCLL}}$	45ns	—	—
SCL High Time	$t_{\text{SCLH}}$	45ns	—	—
SCL Rise Time	$t_{\text{r}}$	—	—	15ns
SCL Fall Time	$t_{\text{f}}$	—	—	15ns

\* Requires more than 100ns after resetting software

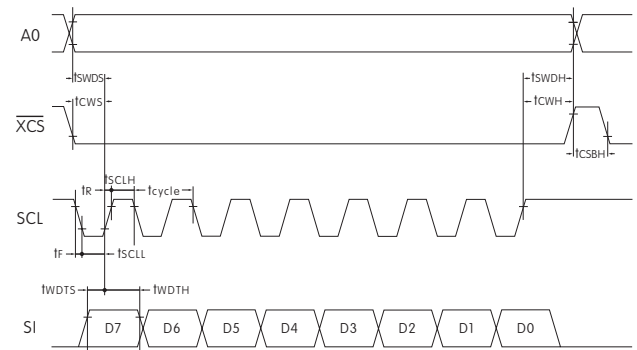

## BLOCK DIAGRAM & PIN CONFIGURATIONS



IS18WWC1W

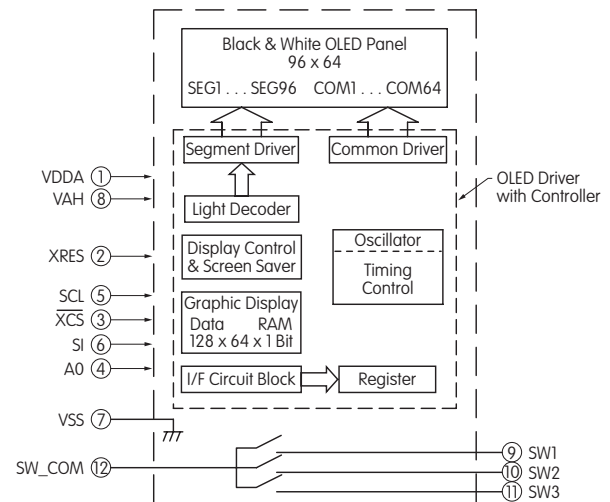

Pin No.	Symbol	Name	Function
①	VDDA	Logic Type Power Source	
②	XRES	Reset	Terminal to initialize IC built-in logic; initializes with low level
③	$\overline{\text{XCS}}$	Chip Select	Slave select for SPI. This line is active low.
④	A0	Address	Terminal to input control signals of command/parameter Set low at time of command input and high level at the time of parameter input.
⑤	SCL	Serial Clock	Read command/parameter at time of SCL signal standing up
⑥	SI	Serial Data Input	Terminal to input command/parameter by SPI
⑦	VSS	Ground	
⑧	VAH	Drive Type Power Source	
⑨	SW1	Switch Terminal 1	N/O
⑩	SW2	Switch Terminal 2	N/O
⑪	SW3	Switch Terminal 3	N/O
⑫	SW_COM	Switch Common Terminal	

## SMARTSWITCH TYPICAL DIMENSIONS

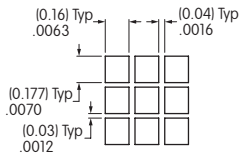
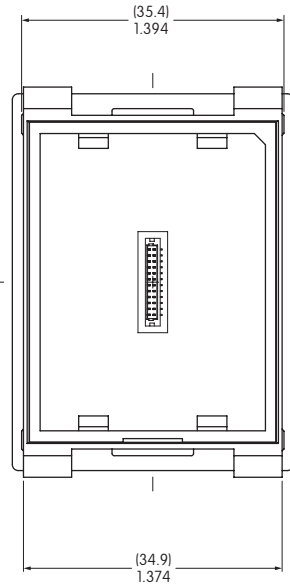
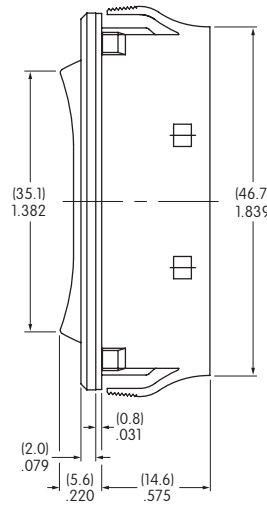
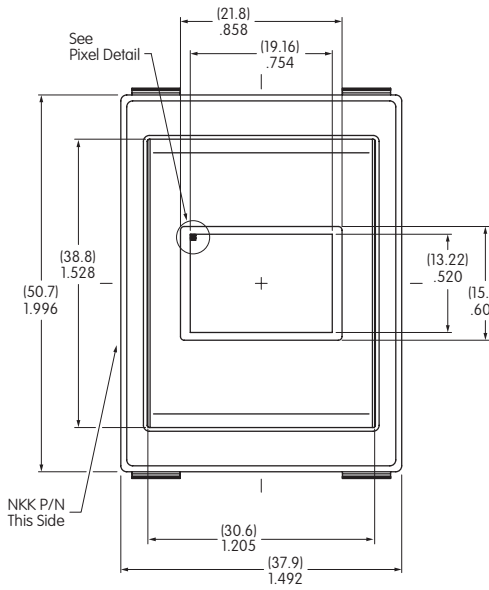

Pixel Detail

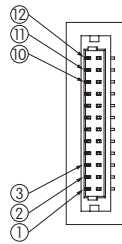

Terminal Connector Detail

### Panel Thickness Range

.039 ~ .157"  
(1.0mm ~ 4.0mm)

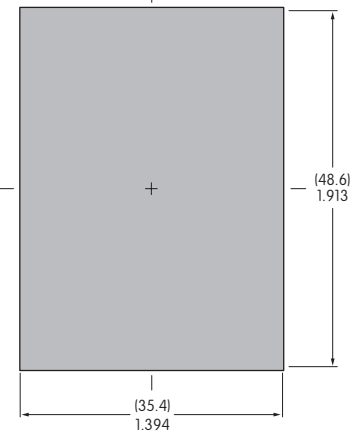

## STATE TRANSITION

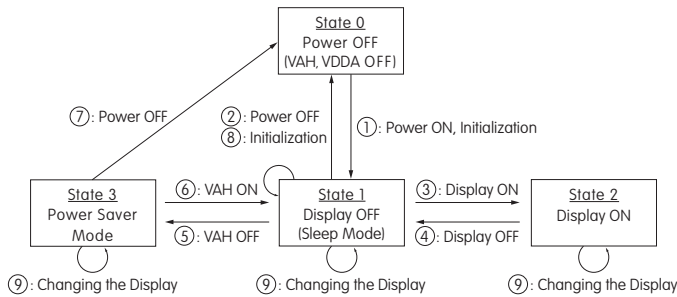

State Number	State	Display	Sleep	VAH	VDDA	Changing the Display
0	Power OFF	OFF	—	OFF	OFF	Disable
1	Display OFF	OFF	ON	ON	ON	Enable
2	Display ON	ON	OFF	ON	ON	Enable
3	Power Saver	OFF	ON	OFF	ON	Enable

### Power ON/OFF Sequence

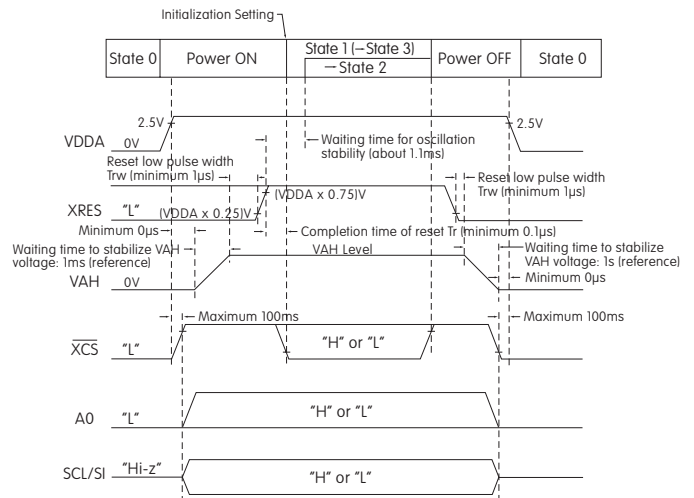

STATE TRANSITION (CONTINUED)

State Transition	Transition	Reference or Setting Procedure
①	Power ON	Refer to "Power ON/OFF Sequence" → Refer to "Initialization Setting"
②	Power OFF	Refer to "Power ON/OFF Sequence"
③	Display ON	Refer to "Display ON/OFF Sequence"
④	Display OFF	
⑤	VAH OFF	Wait until VAH becomes stable
⑥	VAH ON	
⑦	Power OFF	Refer to "Power ON/OFF Sequence"
⑧	Initialization	Refer to "Initialization Setting"
⑨	Display Change	Image Rewriting 96 x 64 Image Data Sending
		Display Settings Dimmer/Screen Saver/Indication 180° Reversal

INITIALIZATION SETTING

Command Name	Command Address	Parameter (1 or 2Byte)	Remarks
Software Reset	01		
Dot Matrix Display ON/OFF	02	00	Note 1
Read/Write Operation Wetting	07	00	Note 1
Display Direction Set Command	09	00	Note 1
Reserved 1	10	03	Note 2
Reserved 2	12	63	Note 2
Reserved 3	13	00	Note 2
Dot Matrix Display Standby ON/OFF	14	00	
Reserved 4	16	00	Note 2
Reserved 5	17	00	Notes 1 & 2
Reserved 6	18	09	Note 2
Reserved 7	1A	04	Notes 1 & 2
Reserved 8	1C	00	Notes 1 & 2
Graphic Memory Writing Direction	1D	00	Note 1
Setting Column Output Range	30	005F	Note 1
Setting Row Output Range	32	003F	Note 1
X Axis Reading/Writing Start Point	34	00	Note 1
X Axis Reading/Writing End Point	35	0B	Note 1
Y Axis Reading/Writing Start Point	36	00	Note 1
Y Axis Reading/Writing End Point	37	3F	Note 1

Notes: 1. Same as default value  
2. Do not change setting value

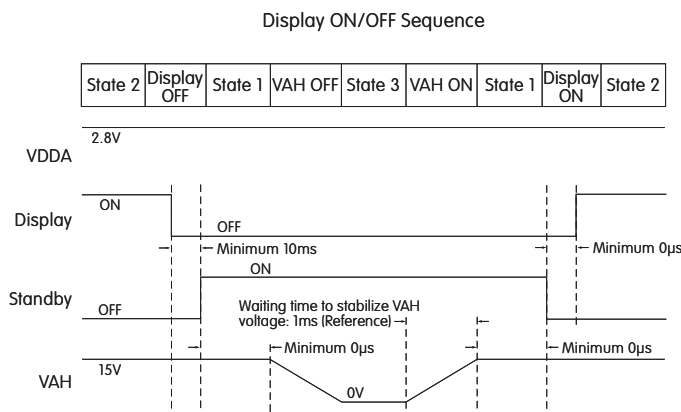

Command Name	Command Address	Parameter (1 or 2Byte)	Remarks
X Axis Reading Start Address	38	00	Note 1
Y Axis Reading Start Address	39	00	Note 1
Reserved 9	48	03	Note 2
Screen Saver Event Timer Setting Command	C3	00	Note 1
Screen Saver Event Timer Setting Command	C4	00	Note 1
One Time, Repeat or Direction Setting for Screen Saver	CC	00	Note 1
Start/Stop Setting for Screen Saver	CD	00	Note 1
System Clock Division Ratio Setting	D0	80	Note 2
Setting the STBY Pin	D2	00	Notes 1 & 2
DACA Setting	D4	00	Note 2
DACB Setting	D5	00	Note 2
DACC Setting	D6	00	Note 2
DACD Setting	D7	00	Note 2
Reserved 10	D9	00	Notes 1 & 2
Dimmer Setting	DB	0F	Note 1
Reserved 11	DD	88	Note 2
Image Writing	08	Image data	

Notes: 1. Same as default value  
2. Do not change setting value

## ACCESSORIES

### AT715 Cable for Connection

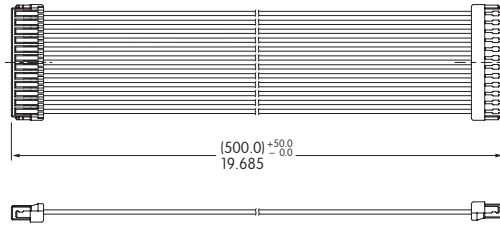

## PRECAUTIONS FOR HANDLING & STORAGE OF OLED ROCKERS

### Handling

1. OLED devices are electrostatic sensitive.
2. Signal input under conditions not recommended may cause damage to the OLED unit or deterioration of the display. Follow directions regarding supply sequences of power and signal voltages.
3. If the OLED panel is broken, avoid touching the contents. Wash off in case of contact to the skin or clothing.
4. Limit operating force to 100.0N maximum, as excessive pressure may damage the display.
5. Under certain actuation conditions, one side of the rocker and the center switch can both send actuation signals.
6. Pixels acquire diminished brightness over time and use, and those most frequently habituated have greater reduction of brightness than those less used. To minimize this difference, operate OLED unit so that all pixels are used as consistently as possible.
7. Clean actuator surface with dry cloth. If further cleaning is needed, wipe with dampened cloth using neutral cleanser and dry with clean cloth. Do not use organic solvent.



### Storage

1. Store in original container and away from direct sunlight.
2. Keep away from static electricity.
3. Avoid extreme temperatures, high humidity, gaseous substances, and all forms of chemical contamination.

### Panel Mounting

- Before snapping a switch into the panel, align the gasket evenly under the bezel of the switch.
- When mounting into a panel, apply equal pressure to sides of bezel and insert parallel to the panel.
- After mounting, be sure there are no gaps between switch and panel. Lightly push into panel.
- After installing into panel, do not apply excessive force.
- After panel installation and wiring is completed, do not apply force horizontally or vertically from behind panel.
- Behind the panel, cut area should be squared. If front of panel is painted, do not allow any paint to collect in corners of cutout to prevent level mounting.
- Avoid reinstalling a switch once it has been mounted into panel. This may cause deterioration of panel sealability.

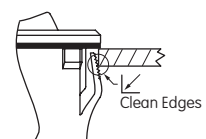
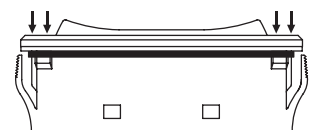
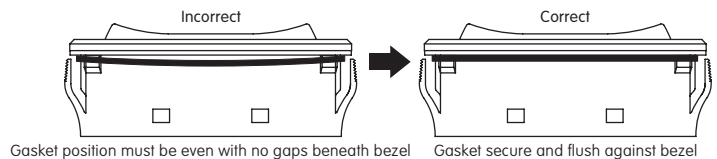



HIGH RESOLUTION LCDS

Pushbutton • Short Travel

IS15EBFP4RGB-09YN

Programmable Display; High Resolution: 64 x 32 Pixels  
 Backlight RGB: 64 colors; Black & White LCD  
 Up to 4 Lines with 10 Characters Each  
 Page E22



Pushbutton • Long Travel

IS15EBFP4RGB

Programmable Display; High Resolution: 64 x 32 Pixels  
 Backlight RGB: 64 colors; Black & White LCD  
 Up to 4 Lines with 10 Characters Each  
 Page E22



Display

IS01EBFRGB

Programmable Display; High Resolution: 64 x 32 Pixels  
 Backlight RGB: 64 colors; Black & White LCD  
 Up to 4 Lines with 10 Characters Each  
 Page E26



Compact Pushbutton

IS15ESBFP4RGB

Programmable Display; High Resolution: 64 x 32 Pixels  
 Backlight RGB: 64 colors; Black & White LCD  
 Up to 4 Lines with 10 Characters Each  
 Page E28



For All LCD 64 x 32 Switches & Displays

- Timing Specifications Page E31
- Bitmap Page E31
- Commands & Data Page E32
- Handling & Storage Page E33

- Toggle
- Rockers
- Pushbuttons
- Illuminated PB
- E** Programmable
- Key locks
- Rotaries
- Slides
- Tactiles
- Tilt
- Touch
- Indicators
- Accessories
- Supplement

### DISTINCTIVE CHARACTERISTICS

- Programmable display graphics for alphanumeric characters and animated sequences
- 64 colors of backlighting can be controlled dynamically
- Pushbutton switches or display with LCD, RGB LED backlighting
- General brightness of backlight is dynamically controlled in eight steps from dark to bright
- Operated by commands and data supplied via serial communications (SPI)
- Incorporates bitmap display function
- Dual image VRAM for quick change of displayed images
- Travel options: Short travel of 1.8mm, or long travel of 4.5mm (same as KP01 Series)
- Low energy consumption
- Dust tight construction

#### Viewing areas:

Switches - 17.0mm x 13.0mm (horizontal x vertical)

Display - 14.4mm x 11.8mm

High reliability and long life of one million (short travel) or three million (long travel) actuations

High resolution of 64 x 32 pixels

Epoxy sealed straight PC terminals

Snap-in standoff legs on the switches, or display's bracket with crimped legs, ensure secure mounting and alignment and prevent dislodging during wave soldering.

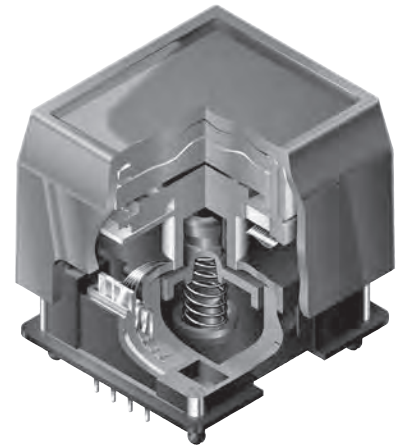

Actual Sizes of Switches & Display

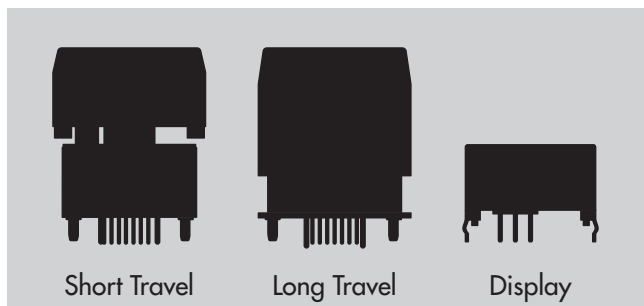



**IS15EBFP4RGB-09YN**  
 RGB LED Backlight  
 Black and White LCD  
 Short Travel

**IS15EBFP4RGB**  
 RGB LED Backlight  
 Black and White LCD  
 Long Travel



## SWITCH PART NUMBERS & DESCRIPTION

Part Numbers	Switch Description	LCD Mode	LED Color
<b>IS15EBFP4RGB-09YN</b> <b>IS15EBFP4RGB</b>	SPST Momentary ON Gold Contacts Straight PC Terminals	Black & White FSTN Positive	Red/Green/Blue

## SWITCH SPECIFICATIONS

	Short Travel	Long Travel
<b>Circuit</b>	SPST normally open	SPST normally open
<b>Electrical Capacity (Resistive Load)</b>	100mA @ 12V DC	100mA @ 12V DC
<b>Contact Resistance</b>	200 milliohms maximum @ 20mV 10mA	200 milliohms maximum @ 20mV 10mA
<b>Insulation Resistance</b>	100 megohms minimum @ 100V DC	100 megohms minimum @ 100V DC
<b>Dielectric Strength</b>	125V AC for 1 minute minimum	125V AC for 1 minute minimum
<b>Mechanical Endurance</b>	1,000,000 operations minimum	3,000,000 operations minimum
<b>Electrical Endurance</b>	1,000,000 operations minimum	3,000,000 operations minimum
<b>Operating Force</b>	1.7 ± 0.5 Newtons	2.0 ± 0.5 Newtons
<b>Total Travel</b>	1.8mm (.071")	4.5mm (.177")

## TYPICAL SWITCH DIMENSIONS FOR SHORT TRAVEL

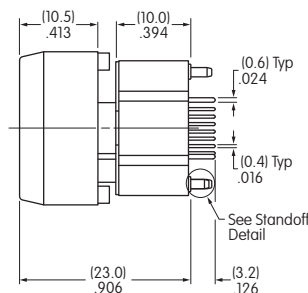
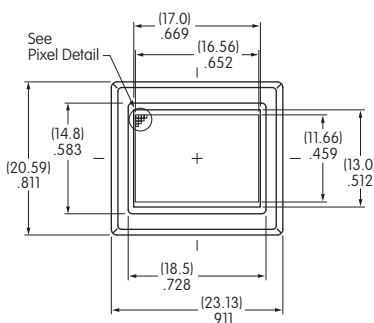

Terminal numbers are not on the switch.

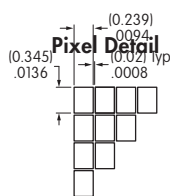
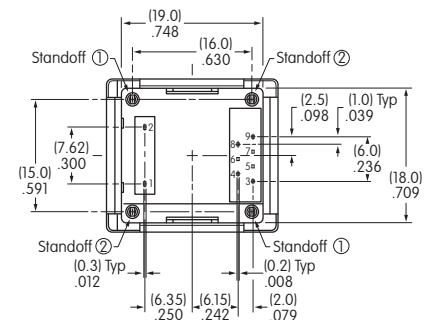

**Standoff Detail**

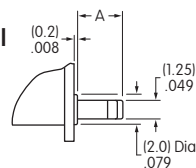

**Footprint**

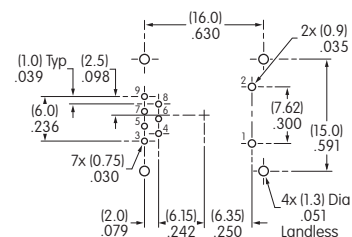

**Dimension A**  
 Standoff 1 = (2.7) .106 Standoff 2 = (2.3) .091

The Compact LCD 64 x 32 Pushbutton may utilize the same footprint as the Short Travel LCD 64 x 32 Pushbutton.

### TYPICAL SWITCH DIMENSIONS FOR LONG TRAVEL

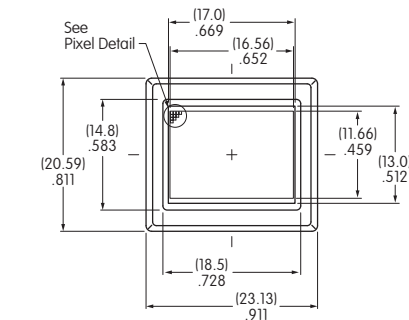

Pixel Detail

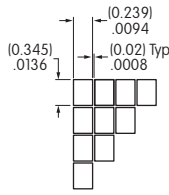

Standoff Detail

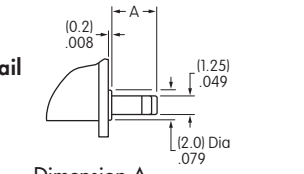

Standoff 1 = (2.7) .106  
Standoff 2 = (2.3) .091

Terminal numbers are not on the switch.

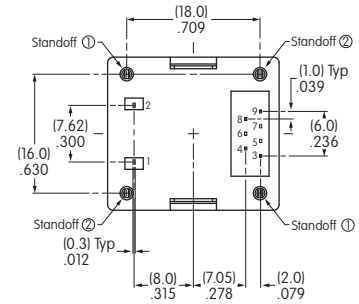

Footprint

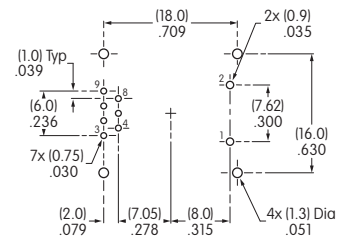

The following pages for Wide View LCD 64 x 32 Pushbuttons apply to the both Short Travel and Long Travel LCD 64 x 32 Pushbuttons.

### LCD SPECIFICATIONS

#### Characteristics of Display

Display Operation Mode	FSTN positive; background colors, black & white
Display Condition	Transflective with built-in LED backlight
Viewing Angle Direction	6 o'clock
Viewing Area	17.0mm x 13.0mm (horizontal x vertical)
Pixel Format	64 x 32 pixels (horizontal x vertical)
Pixel Size	0.239mm x 0.345mm (horizontal x vertical)
*Operating Temperature Range	-15°C ~ +50°C (+5°F ~ +122°F)
Storage Temperature Range	-20°C ~ +60°C (-4°F ~ +140°F)
Backlight LED	RGB: red/green/blue

\* In a low temperature environment (below 0°C), speed and contrast decrease when image changes. The non-indicator dot may become dense in a high temperature environment (about +50°C). Highest backlight brightness level should not be used for temperatures above +35°C.

#### Absolute Maximum Ratings (Temperature at 25°C)

Items	Symbols	Ratings
Supply Voltage	V <sub>DD</sub>	-0.3V to +7.0V
Input Voltage	V <sub>I</sub>	-0.3V to V <sub>DD</sub> +0.3V
Output Voltage	V <sub>O</sub>	-0.3V to V <sub>DD</sub> +0.3V

#### Optical Characteristics (Temperature at 25°C)

Items	Symbols	Min	Typical	Max
Contrast Ratio	Cr	—	3.0	—
Viewing Angle (Cr ≥ 1.1)	Up & Down	θ	90°	—
	Right & Left	φ	90°	—

## Recommended Operating Conditions (Temperature at 25°C)

Items	Symbols	Minimum	Typical	Maximum
Supply Voltage	$V_{DD}$	4.9V	5.0V	5.1V
High Level Input Voltage	$V_{IH}$	0.8 $V_{DD}$	—	—
Low Level Input Voltage	$V_{IL}$	—	—	0.2 $V_{DD}$
SPI Clock Frequency	$f_{SCK}$	—	—	8MHz
Current Consumption	$I_{DD}$	** 10mA	—	*** 60mA

\*\* 10mA: Backlighting LED is off

\*\*\* 60mA: Backlighting LEDs (Red, Green, Blue) are maximum brightness

## SWITCH BLOCK DIAGRAM & PIN CONFIGURATIONS

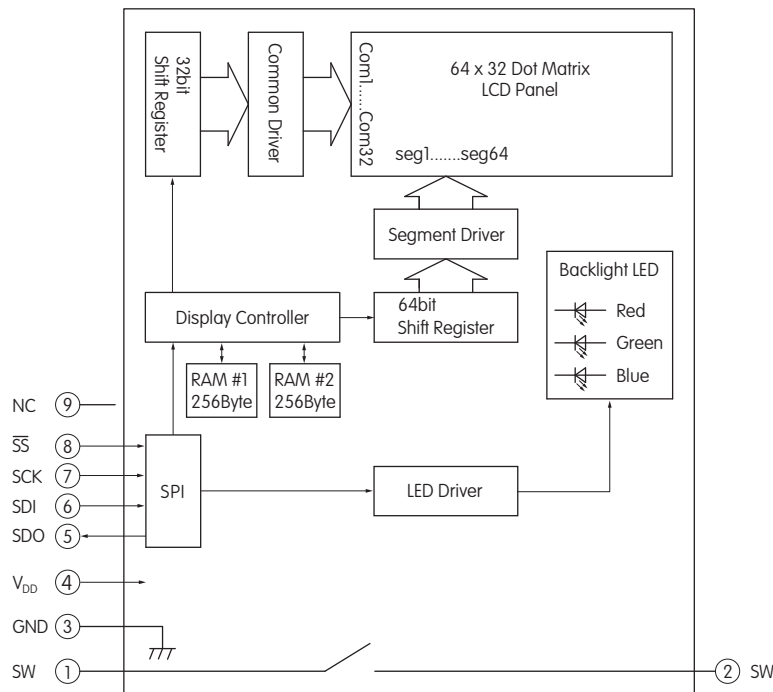

Pin No.	Symbol	Name	Function
①	SW	Terminal of Switch	Normally open
②	SW	Terminal of Switch	Normally open
③	GND	Ground	
④	$V_{DD}$	Power	Power source for logic circuit and LCD
⑤	SDO	Data Out	Data output line for SPI
⑥	SDI	Data In	Data input line for SPI
⑦	SCK	Serial Clock	Clock line for SPI that synchronizes commands and data
⑧	$\overline{SS}$	Slave Select	Chip select for SPI; line is active low
⑨	NC	None	No connection

### DISPLAY PART NUMBER & DESCRIPTION

Part Number	Terminals	LCD Mode	LED Color
<b>ISO1EBFRGB</b>	Straight PC	Black & White FSTN Positive	Red/Green/Blue

### LCD SPECIFICATIONS

#### Characteristics of Display

Display Operation Mode	FSTN positive; background colors, black & white
Display Condition	Transflective with built-in LED backlight
Viewing Angle Direction	6 o'clock
Viewing Area	14.4mm x 11.8mm (horizontal x vertical)
Pixel Format	64 x 32 pixels (horizontal x vertical)
Pixel Size	0.200mm x 0.285mm (horizontal x vertical)
* Operating Temperature Range	-15°C ~ +50°C (+5°F ~ +122°F)
Storage Temperature Range	-20°C ~ +60°C (-4°F ~ +140°F)
Backlight LED	<b>RGB:</b> red/green/blue

\* In a low temperature environment (below 0°C), speed and contrast decrease when image changes. The non-indicator dot may become dense in a high temperature environment (about +50°C). Highest backlight brightness level should not be used for temperatures above +35°C.

#### Recommended Operating Conditions (Temperature at 25°C)

Items	Symbols	Minimum	Typical	Maximum
Supply Voltage	V <sub>DD</sub>	4.9V	5.0V	5.1V
High Level Input Voltage	V <sub>IH</sub>	0.8 V <sub>DD</sub>	—	—
Low Level Input Voltage	V <sub>IL</sub>	—	—	0.2V <sub>DD</sub>
SPI Clock Frequency	f <sub>SCK</sub>	—	—	8MHz
Current Consumption	I <sub>DD</sub>	** 10mA	—	*** 60mA

\*\* 10mA: Backlighting LED is off

\*\*\* 60mA: Backlighting LEDs (Red, Green, Blue) are maximum brightness

#### Absolute Maximum Ratings (Temperature at 25°C)

Items	Symbols	Ratings
Supply Voltage	V <sub>DD</sub>	-0.3V to +7.0V
Input Voltage	V <sub>I</sub>	-0.3V to V <sub>DD</sub> +0.3V
Output Voltage	V <sub>O</sub>	-0.3V to V <sub>DD</sub> +0.3V

#### Optical Characteristics (Temperature at 25°C)

Items	Symbols	Minimum	Typical	Maximum
Contrast Ratio	Cr	—	3.0	—
Viewing Angle (Cr ≥ 1.1)	Up & Down	θ	—	90°
	Right & Left	φ	—	90°

## DISPLAY BLOCK DIAGRAM & PIN CONFIGURATIONS

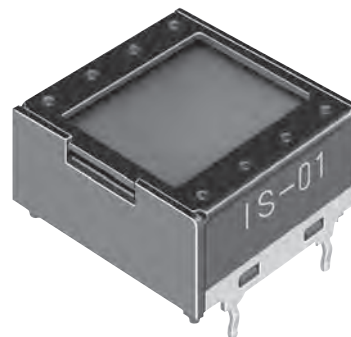
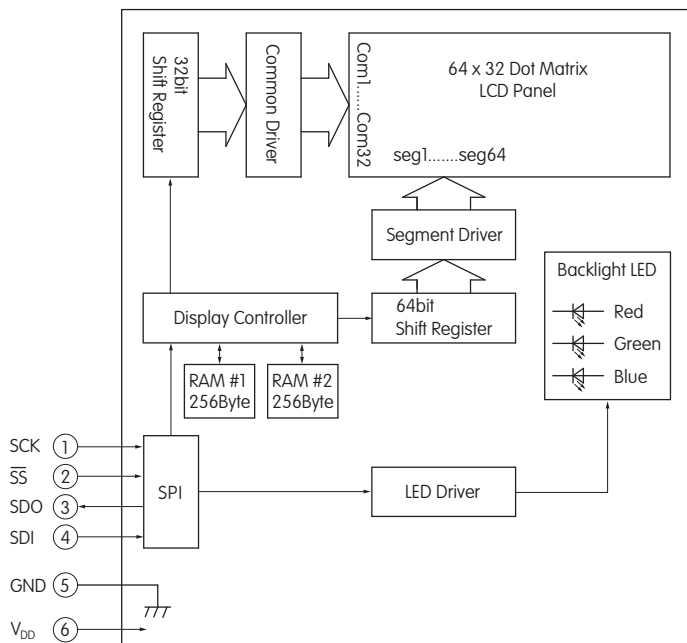

**ISO1EBFRGB**  
RGB LED Backlight  
Black and White LCD

Pin No.	Symbol	Name	Function
①	SCK	Serial Clock	Clock line for SPI that synchronizes commands and data
②	$\overline{SS}$	Slave Select	Chip select for SPI; line is active low
③	SDO	Data Out	Data output line for SPI
④	SDI	Data In	Data input line for SPI
⑤	GND	Ground	
⑥	V <sub>DD</sub>	Power	Power source for logic circuit and LCD

## TYPICAL DISPLAY DIMENSIONS

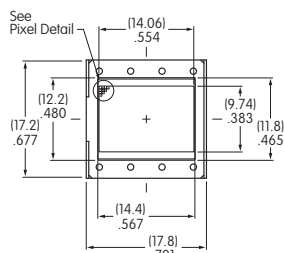

Pixel Detail

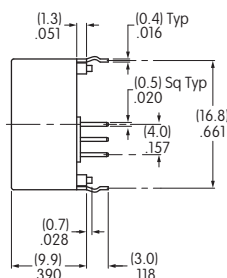
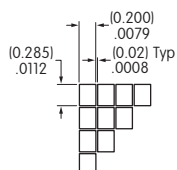

Footprint

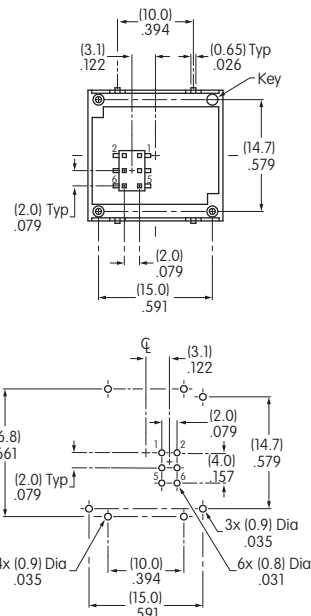

Terminal numbers are not on the device.

### DISTINCTIVE CHARACTERISTICS

#### Compact Size Combined with High Resolution

- High resolution of 64 x 32 pixels
- 64 colors of backlighting can be controlled dynamically
- Pushbutton switch with LCD, RGB LED backlighting
- General brightness of backlight is dynamically controlled in eight steps from dark to bright
- Operated by commands and data supplied via serial communications (SPI)
- Can display as many as four lines of text with ten characters each
- Incorporates bitmap display function
- Programmable display graphics for alphanumeric characters and animated sequences
- Dual image VRAM for quick change of displayed images
- Low energy consumption
- Dust tight construction

Viewing area: 14.5mm x 11.8mm (horizontal x vertical)

Variety of LED backlighting with 64 colors and 8 steps brightness

Dome gives crisp tactile feedback to positively indicate circuit transfer

Epoxy sealed straight PC terminals

Snap-in standoff for easy, secure mounting and alignment



Actual Size

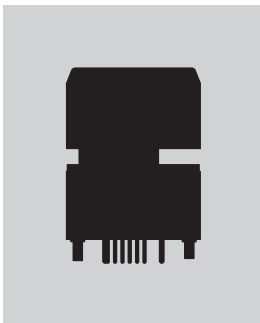

### PART NUMBER & DESCRIPTION

Part Number	Switch Description	LCD Mode	LED Color
<b>IS15ESBFP4RGB</b>	SPST Momentary ON Gold Contacts Straight PC Terminals	Black & White FSTN Positive	Red/Green/Blue



## SWITCH SPECIFICATIONS

Circuit	SPST normally open
Electrical Capacity (Resistive Load)	100mA @ 12V DC
Contact Resistance	200 milliohms maximum @ 20mV 10mA
Insulation Resistance	100 megohms minimum @ 100V DC
Dielectric Strength	125V AC for 1 minute minimum
Mechanical Endurance	1,000,000 operations minimum
Electrical Endurance	1,000,000 operations minimum
Operating Force	1.7 ± 0.5 Newtons
Total Travel	1.8mm (.071")

## Absolute Maximum Ratings (Temperature at 25°C)

Items	Symbols	Ratings
Supply Voltage	V <sub>DD</sub>	-0.3V to +7.0V
Input Voltage	V <sub>I</sub>	-0.3V to V <sub>DD</sub> +0.3V
Output Voltage	V <sub>O</sub>	-0.3V to V <sub>DD</sub> +0.3V

## Optical Characteristics (Temperature at 25°C)

Items	Symbols	Minimum	Typical	Maximum
Contrast Ratio	Cr	—	3.0	—
Viewing Angle (Cr ≥ 1.1)	Up & Down	θ	90°	—
	Right & Left	φ	90°	—

## LCD SPECIFICATIONS

## Characteristics of Display

Display Operation Mode	FSTN positive; background colors, black & white
Display Condition	Transflective with built-in LED backlight
Viewing Angle Direction	6 o'clock
Viewing Area	14.5mm x 11.8mm (horizontal x vertical)
Pixel Format	64 x 32 pixels (horizontal x vertical)
Pixel Size	0.200mm x 0.285mm (horizontal x vertical)
* Operating Temp Range	-15°C ~ +50°C (+5°F ~ +122°F)
Storage Temp Range	-20°C ~ +60°C (-4°F ~ +140°F)
Backlight LED	RGB: red/green/blue

\* In a low temperature environment (below 0°C), speed and contrast decrease when image changes. The non-indicator dot may become dense in a high temperature environment (about +50°C). Highest backlight brightness level should not be used for temperatures above +35°C.

## Recommended Operating Conditions (Temperature at 25°C)

Items	Symbols	Minimum	Typical	Maximum
Supply Voltage	V <sub>DD</sub>	4.9V	5.0V	5.1V
High Level Input Voltage	V <sub>IH</sub>	0.8 V <sub>DD</sub>	—	—
Low Level Input Voltage	V <sub>IL</sub>	—	—	0.2V <sub>DD</sub>
SPI Clock Frequency	f <sub>SCK</sub>	—	—	8MHz
Current Consumption	I <sub>DD</sub>	** 10mA	—	*** 60mA

\*\* 10mA: Backlighting LED is off

\*\*\* 60mA: Backlighting LEDs (Red, Green, Blue) are maximum brightness

### BLOCK DIAGRAM & PIN CONFIGURATIONS



**IS15ESBFP4RGB**  
RGB LED Backlight  
Black and White LCD

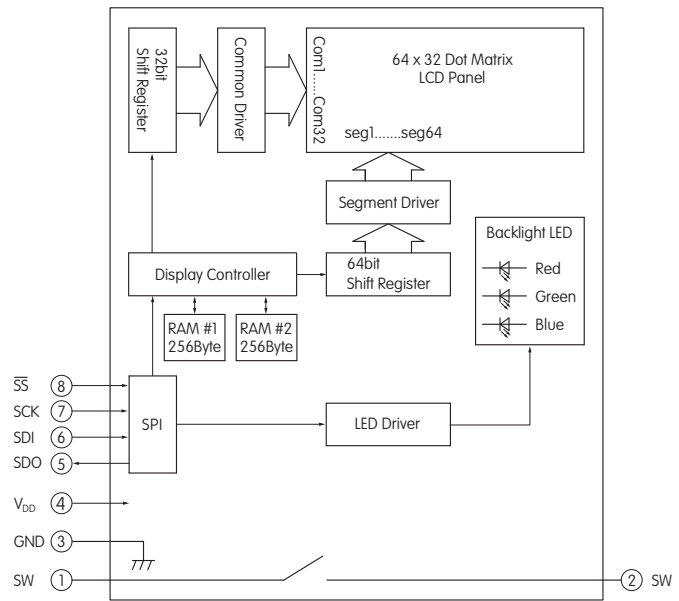

Pin No.	Symbol	Name	Function
①	SW	Terminal of Switch	Normally open
②	SW	Terminal of Switch	Normally open
③	GND	Ground	
④	V <sub>DD</sub>	Power	Power source for logic circuit and LCD
⑤	SDO	Data Out	Data output line for SPI
⑥	SDI	Data In	Data input line for SPI
⑦	SCK	Serial Clock	Clock line for SPI that synchronizes commands and data
⑧	SS	Slave Select	Chip select for SPI; line is active low

### TYPICAL SWITCH DIMENSIONS

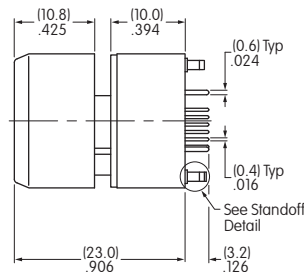
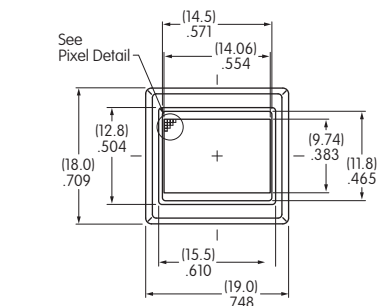

Terminal numbers are not on the switch.

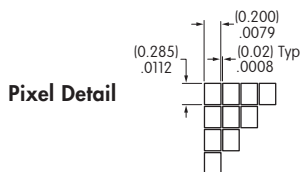
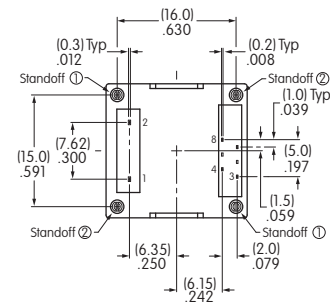

Standoff Detail

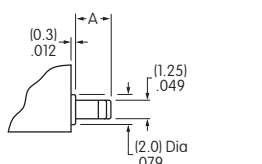

Footprint

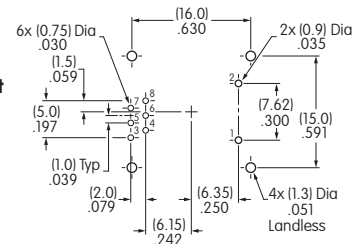

Dimension A

Standoff 1 = (2.7) .106      Standoff 2 = (2.3) .091

The Compact LCD 64 x 32 Pushbutton may utilize the same footprint as the Short Travel LCD 64 x 32 Pushbutton.

TIMING SPECIFICATIONS FOR SWITCHES & DISPLAY

SPI Characteristics (See Timing Diagram)

(Temperature at -15°C ~ +50°C and V<sub>DD</sub> = 5.0V ± 2%)

Items	Symbols	Minimum	Maximum
SPI $\overline{SS}$ Set Up Time	$t_{sSS}$	10ns	
SPI $\overline{SS}$ Hold Time	$t_{hSS}$	10ns	
SPI_CLK Cycle	$t_{cycCK}$		8MHz
SPI_CLK Width	$t_{hwCK}$	10ns	
SPI_DI Set Up Time	$t_{sDI}$	10ns	
SPI_DI Hold Time	$t_{hDI}$	10ns	
SPI_DO Delay Time	$t_{dDO}$	10ns	

SPI Timing Chart ( $\overline{SS}$  Using)

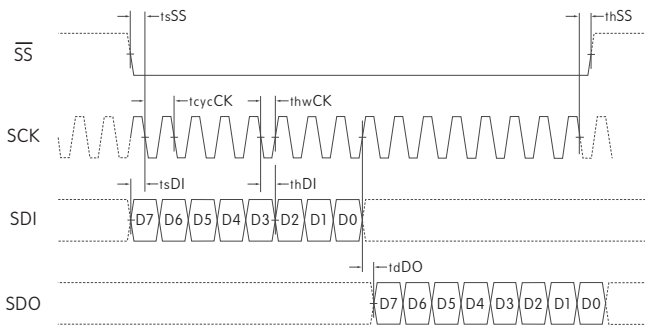

Circuit Example

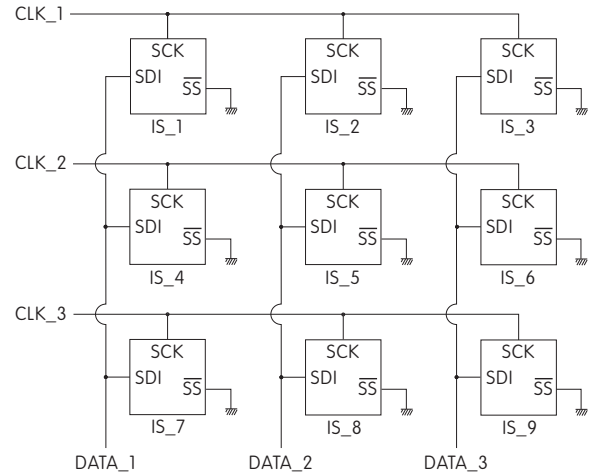

It is recommended that all  $\overline{SS}$  pins be connected to a controller pin instead of ground. A clock glitch during power up could cause the communication to fall out of sync. Toggling the  $\overline{SS}$  line resets the communication.

SPI Timing Chart ( $\overline{SS}$  Low Level Fixed)

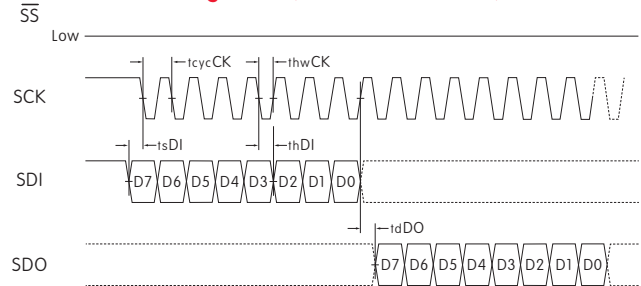

SDI and SCK shall be kept high when idle.

BITMAP

Common	Segment								9 • • • 16	• • • • •	49 • • • 56	57 58 59 60 61 62 63 64		
	Byte8								Byte7	• • •	Byte2	Byte1		
COM1	D0 D1 D2 D3 D4 D5 D6 D7	D0 • • • D7								• • •	D0 • • • D7	D0 D1 D2 D3 D4 D5 D6 D7		
	Byte16								Byte9					
COM2	D0 D1 D2 D3 D4 D5 D6 D7											D0 D1 D2 D3 D4 D5 D6 D7		
•												•		
•												•		
•												•		
	Byte256								• • •	• • •	Byte249			
COM32	D0 D1 D2 D3 D4 D5 D6 D7											D0 D1 D2 D3 D4 D5 D6 D7		

Transferring Display Data/Displaying LCD Command and Data Sequence

Command	Data (256 Bytes)																							
0 x 55	Byte1								Byte2 • • • Byte255								Byte256							
0 1 0 1 0 1 0 1	D7 D6 D5 D4 D3 D2 D1 D0	D7 D6 • • • D1 D0								D7 D6 D5 D4 D3 D2 D1 D0														

Notes: Display RAM has two screen areas. The first area is for the display on current LCD; the second area is for the data to be displayed next. The screens are changed when the second area is fully stored.

### COMMANDS & DATA

- Transferring display data/displaying on LCD: command (1 Byte) + data (256 Bytes)
- Others: command (1 Byte) + data (1 Byte)
- Commands can be accepted only when all bits coincide; otherwise, they are not acknowledged
- Additional commands will not be received until the communication of commands (1 Byte) and data (256 or 1 Byte) is completed
- There is no time limit from the beginning to end of data receipt
- Commands may be executed consecutively (no need to wait between commands)
- Irregular commands or data are not recognized
- Initial status at power activation: LCD display off, LED off (brightness 1/20, color off)

#### Transferring Display Data/Displaying on LCD

Command		Data	Remarks
Hex	Binary		
0 x 55	01010101	256 Bytes (64 x 32 = 2,048 bits)	See above for details of bitmap data

#### LED (Backlight) Color Set

Command		Data	Remarks
Hex	Binary		
0 x 40	01000000	R R G G B B 1 1 2 bits x 3	For each of RGB: 00 = off                    10 = 1/2 01 = 1/4                    11 = full

#### LED (Backlight) Brightness Set

Command		Data	Remarks
Hex	Binary		
0 x 41	01000001	* * * 1 1 1 1 1 3 bits	For leading 3bits: 000 = 1/20 (dark)        100 = 1/3 001 = 1/10                101 = 1/2 010 = 1/7                 110 = 2/3 011 = 1/5                 111 = full (bright)

#### Reset (Returning to Initial Status at Power Activation)

Command		Data	Remarks
Hex	Binary		
0 x 5E	01011110	00000011	Returning to initial status at power activation

## PRECAUTIONS FOR HANDLING &amp; STORAGE OF LCD 64 x 32 DEVICES

**Handling**

1. The IS Series devices are electrostatic sensitive.
2. Limit operating force to keytop to 100.0N maximum, as excessive pressure may damage the LCD device.
3. The IS series devices are not process sealed.
4. If the LCD is accidentally broken, avoid contact with the liquid and wash off any liquid spills to the skin or clothing.
5. Clean cap surface with dry cloth. If further cleaning is needed, wipe with dampened cloth using neutral cleanser and dry with clean cloth. Do not use organic solvent.
6. Recommended soldering time and temperature limits:  
Do not exceed 60°C at the LCD level.  
Wave Soldering: see Profile B in Supplement section.  
Manual Soldering for Switch: see Profile A in Supplement section.  
Manual Soldering for Display: see Profile B in Supplement section.
7. Excessive images may result after the same image is emitted continuously for an extended period of time.
8. The highest backlight brightness level should not be used for temperatures above +35°C.

**Storage**

1. Store in original container and away from direct sunlight.
2. Keep away from static electricity.
3. Avoid extreme temperatures, high humidity, gaseous substances, and all forms of chemical contamination.



Toggles

Rockers

Pushbuttons

Illuminated PB

Programmable  
**E**

Keylocks

Rotaries

Slides

Tactiles

Tilt

Touch

Indicators

Accessories

Supplement

### STANDARD RESOLUTION LCDS

#### Pushbutton

**IS15BBFP4RGB**

Programmable Display; Resolution: 36 x 24 Pixels  
Backlight RGB; Black & White LCD  
Up to 3 Lines with 6 Characters Each  
Page E35

#### Pushbutton

**IS15BAFP4CF**

Programmable Display; Resolution: 36 x 24 Pixels  
Backlight Red/Green; Black & White LCD  
Up to 3 Lines with 6 Characters Each  
Page E35

#### Display

**IS01BBFRGB**

Programmable Display; Resolution: 36 x 24 Pixels  
Backlight RGB; Black & White LCD  
Up to 3 Lines with 6 Characters Each  
Page E39

#### Compact Pushbutton

**IS15BSBFP4RGB**

Programmable Display; Resolution: 36 x 24 Pixels  
Backlight RGB; Black & White LCD  
Up to 3 Lines with 6 Characters Each  
Page E41

#### Compact Pushbutton

**IS15BSAFP4CF**

Programmable Display; Resolution: 36 x 24 Pixels  
Backlight Red/Green; Black & White LCD  
Up to 3 Lines with 6 Characters Each  
Page E41

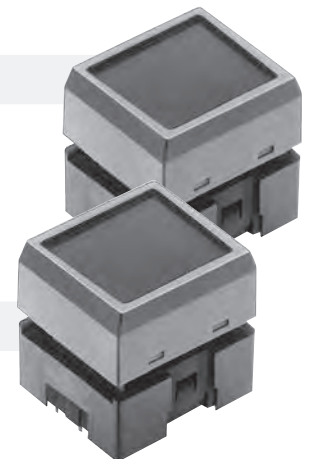
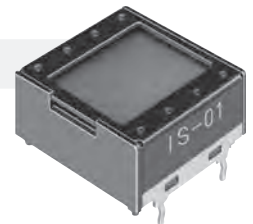

### For All LCD 36 x 24 Switches & Displays

Switch Specifications	Page E44
LCD Specifications	Page E45 - E46
LED Characteristics	Page E46
Handling & Storage	Page E47

Contact factory for additional options.

## DISTINCTIVE CHARACTERISTICS

### Standard with Enhanced LED Illumination:

- Broad and even light diffusion
- Consistent backlighting
- Low energy consumption

Programmable LCD

Variety of LED Backlighting Colors

Rubber Dome

Epoxy Sealed Straight PC Terminals

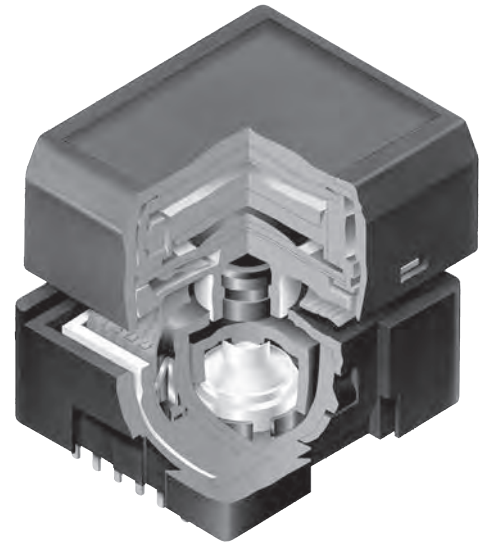

RGB or bicolor red/green backlighting provides infinite color availability.

Programmable to display graphics, alphanumeric characters and animated sequences.

Integrated liquid crystal display provides wide viewing angle with high contrast and clarity.

Viewing area for switches 17.0mm x 13.0mm (horizontal x vertical) at 36 x 24 pixels;  
Display viewing area 14.4mm x 11.8mm.

Dome gives crisp tactile feedback to positively indicate circuit transfer.

High reliability and long life of one million actuations minimum.

Epoxy sealed terminals prevent entry of solder flux and other contaminants.

Optional accessories available to enhance panel design and simplify production process.

Actual Sizes

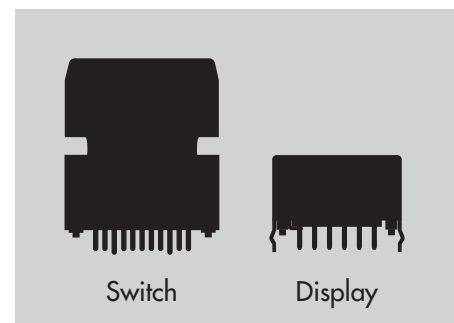

## PART NUMBERS & DESCRIPTIONS

Part Number	Switch Description	LCD Mode	LED Color
<b>IS15BBFP4RGB</b>	SPST Momentary ON Gold Contacts Straight PC Terminals	Black & White FSTN Positive	* Red/Green/Blue
<b>IS15BAFP4CF</b>	SPST Momentary ON Gold Contacts Straight PC Terminals	Black & White FSTN Positive	* Red/Green

\* Simultaneous illumination of LEDs achieves infinite colors.

### CHARACTERISTICS OF DISPLAY

<b>Viewing Area</b>	17.0mm x 13.0mm (horizontal x vertical)
<b>Pixel Size</b>	0.440mm x 0.495mm (horizontal x vertical)
<b>Backlight LED</b>	RGB: red/green/blue Bicolor: red/green

### TYPICAL SWITCH DIMENSIONS FOR RGB

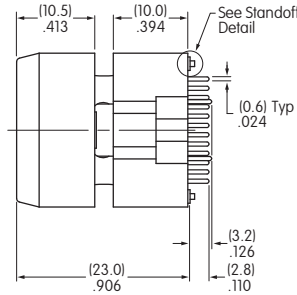
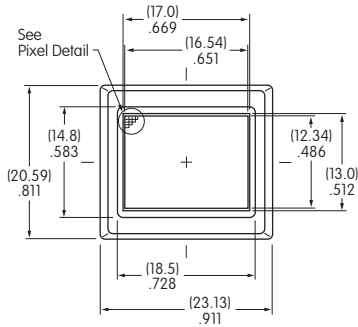

Terminal numbers are not on the switch.

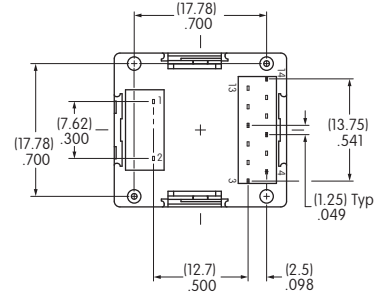

**Bottom View: RGB**

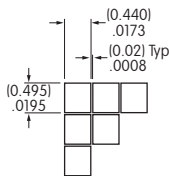

**Pixel Detail**

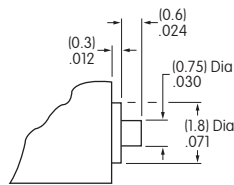

**Standoff Detail**

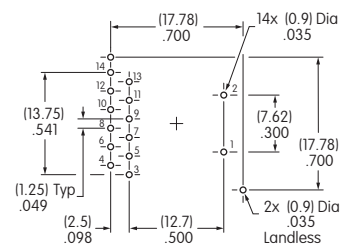

**Footprint: RGB**

### TYPICAL SWITCH DIMENSIONS FOR BICOLOR

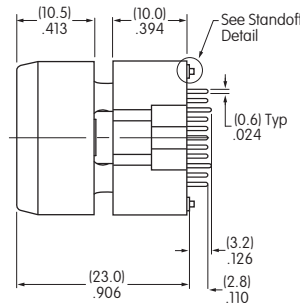
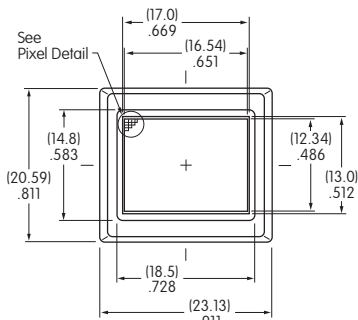

Terminal numbers are not on the switch.

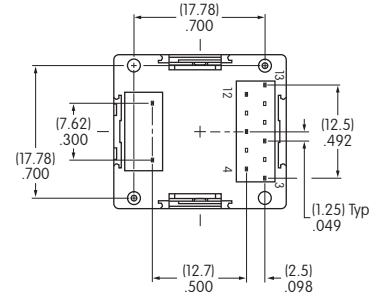

**Bottom View: Bicolor Red & Green**

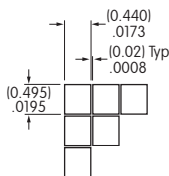

**Pixel Detail**

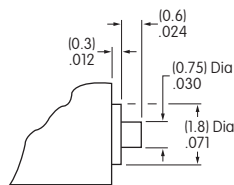

**Standoff Detail**

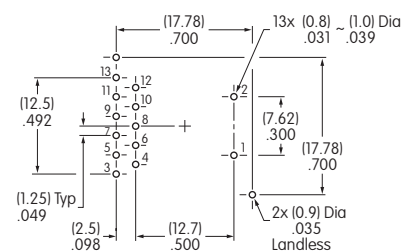

**Footprint: Bicolor Red & Green**



## BLOCK DIAGRAM & PIN CONFIGURATIONS FOR RGB

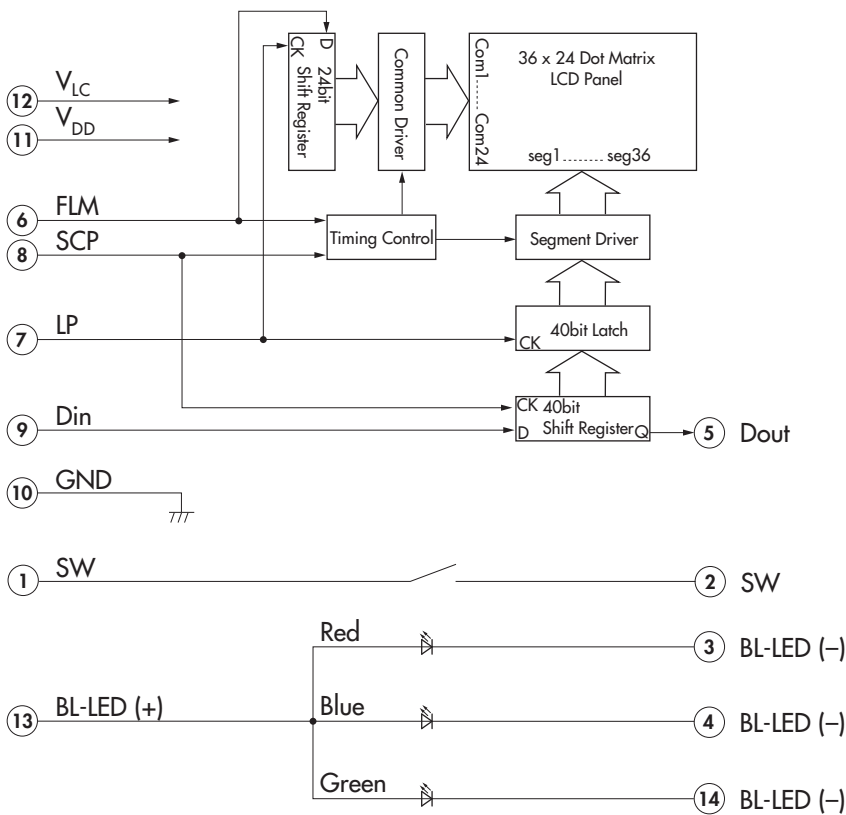

**IS15BBFP4RGB**  
RGB LED Backlight  
Black and White LCD

Pin No.	Symbol	Name	Function
①	SW	Terminal of Switch	Normally open
②	SW	Terminal of Switch	Normally open
③	BL-LED (-)	Terminal of Backlight LED	Cathode for red
④	BL-LED (-)	Terminal of Backlight LED	Cathode for blue
⑤	Dout	Data Output	Display serial output. Can be used to connect to Din of the next SMARTSWITCH. As a result, many SMARTSWITCHES can be controlled with one clock and data signal.
⑥	FLM	First Line Marker	The marking signal for the first line data of LCD display. The first line of LCD will be selected by the falling edge of LP signal during the high level (FLM).
⑦	LP	Latch Pulse	Line data latch pulse will latch content of internal 40-bit shift register at falling edge for one line of display. LP will also increment the display line by one.
⑧	SCP	Serial Clock Pulse	Clock used by 40-bit internal shift register of the switch, shifting the display data bit presented at Din at falling edge.
⑨	Din	Data Input	Display serial data bit. Note: to map the display data, because of the difference between the number of internal shift register data (40) and the single line of LCD pixels (36), the first four bits of data shifted will be dummy bits.
⑩	GND	Ground	
⑪	V <sub>DD</sub>	Power	Power source for logic circuit
⑫	V <sub>LC</sub>	Power	Power source for LCD drive
⑬	BL-LED (+)	Terminal of Backlight LED	Anode for common
⑭	BL-LED (-)	Terminal of Backlight LED	Cathode for green

### BLOCK DIAGRAM & PIN CONFIGURATIONS FOR BICOLOR



**IS15BAFP4CF**  
Red/Green LED Backlight  
Black and White LCD

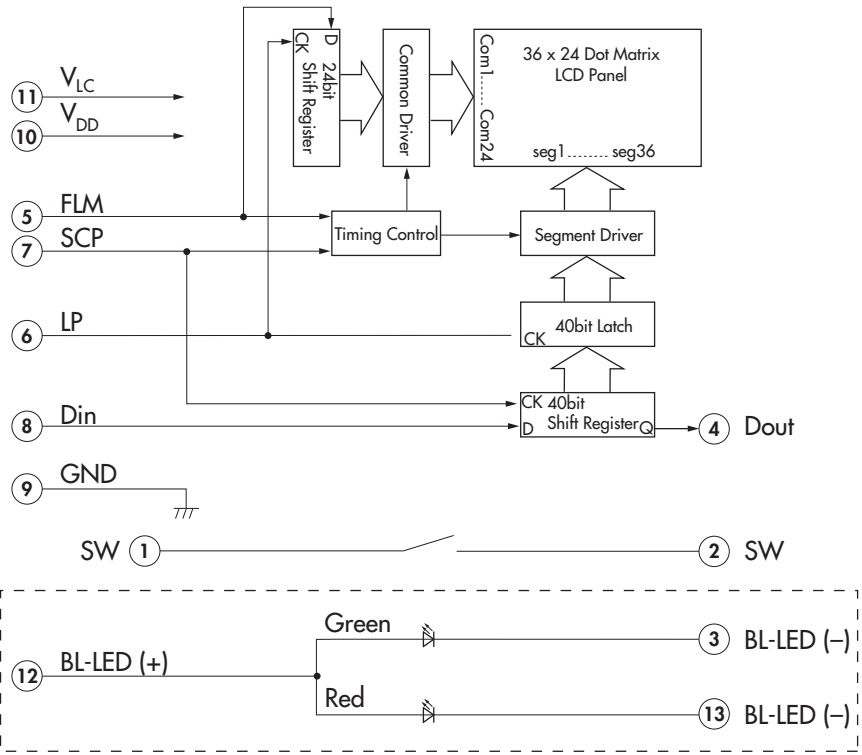

Pin No.	Symbol	Name	Function
①	SW	Terminal of Switch	Normally open
②	SW	Terminal of Switch	Normally open
③	BL-LED (-)	Terminal of Backlight LED	Cathode for green
④	Dout	Data Output	Display serial output. Can be used to connect to Din of the next SMARTSWITCHES. As a result, many SMARTSWITCHES can be controlled with one clock and data signal.
⑤	FLM	First Line Marker	The marking signal for the first line data of LCD display. The first line of LCD will be selected by the falling edge of LP signal during the high level (FLM).
⑥	LP	Latch Pulse	Line data latch pulse will latch content of internal 40-bit shift register at falling edge for one line of display. LP will also increment the display line by one.
⑦	SCP	Serial Clock Pulse	Clock used by 40-bit internal shift register of the switch, shifting the display data bit presented at Din at falling edge.
⑧	Din	Data Input	Display serial data bit. Note: to map the display data, because of the difference between the number of internal shift register data (40) and the single line of LCD pixels (36), the first four bits of data shifted will be dummy bits.
⑨	GND	Ground	
⑩	V <sub>DD</sub>	Power	Power source for logic circuit
⑪	V <sub>LC</sub>	Power	Power source for LCD drive
⑫	BL-LED (+)	Terminal of Backlight LED	Anode for common
⑬	BL-LED (-)	Terminal of Backlight LED	Cathode for red

## DISTINCTIVE CHARACTERISTICS

### Standard with Enhanced Illumination:

Programmable to display graphics, alphanumeric characters and animated sequences.

Standard SMARTDISPLAY™ can be used alone or in conjunction with electromechanical switches.

Integrated liquid crystal display provides wide viewing angle with high contrast and clarity.

RGB LED provides numerous color variations.

Viewing area 14.4mm x 11.8mm (horizontal x vertical) at 36 x 24 pixels.

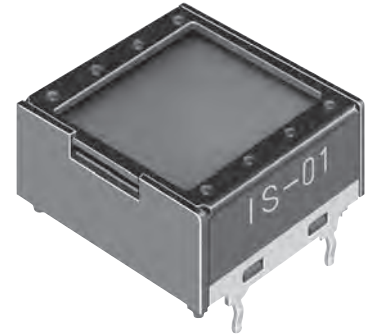

## PART NUMBER & DESCRIPTION

Part Number	Terminals	LCD Mode	LED Color
<b>IS01BBFRGB</b>	Straight PC	Black & White FSTN Positive	* Red/Green/Blue

\* Simultaneous illumination of LED achieves infinite colors.

## CHARACTERISTICS OF DISPLAY

Viewing Area	14.4mm x 11.8mm (horizontal x vertical)
Pixel Size	0.371mm x 0.445mm (horizontal x vertical)
Backlight LED	<b>RGB:</b> red/green/blue

## TYPICAL DISPLAY DIMENSIONS FOR RGB LED

Terminal numbers are not on the device.

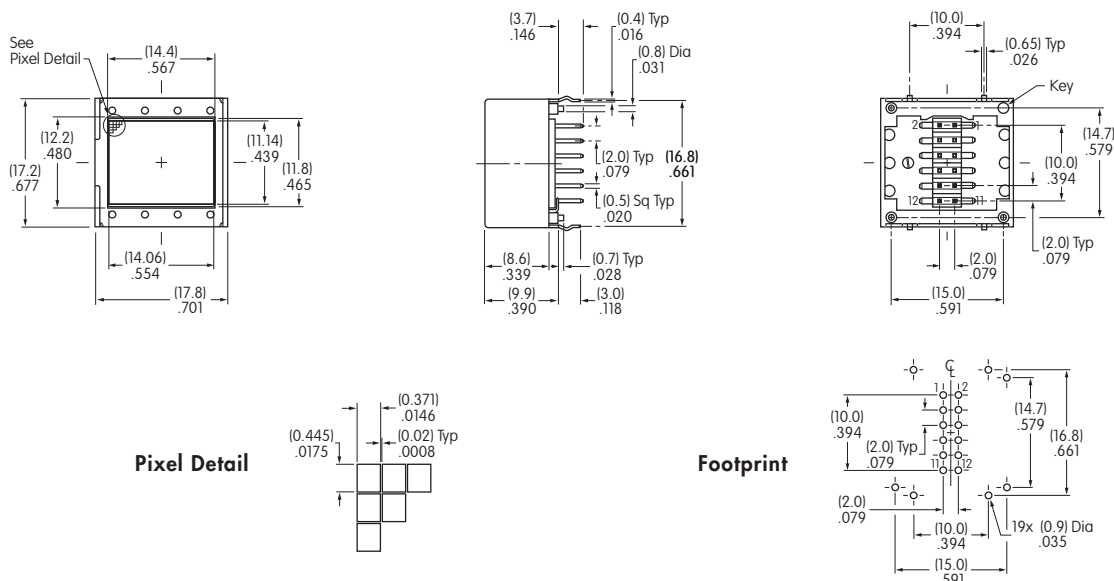

### BLOCK DIAGRAM & PIN CONFIGURATIONS FOR RGB LEDs



**ISO1BBFRGB**  
RGB LED Backlight  
Black and White LCD

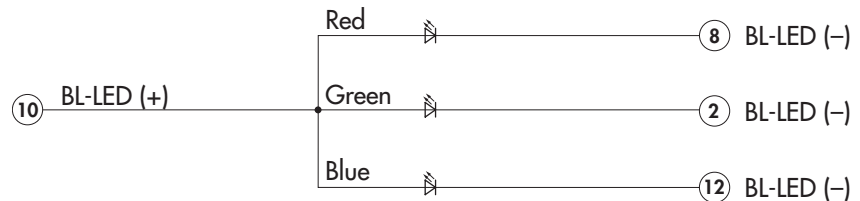
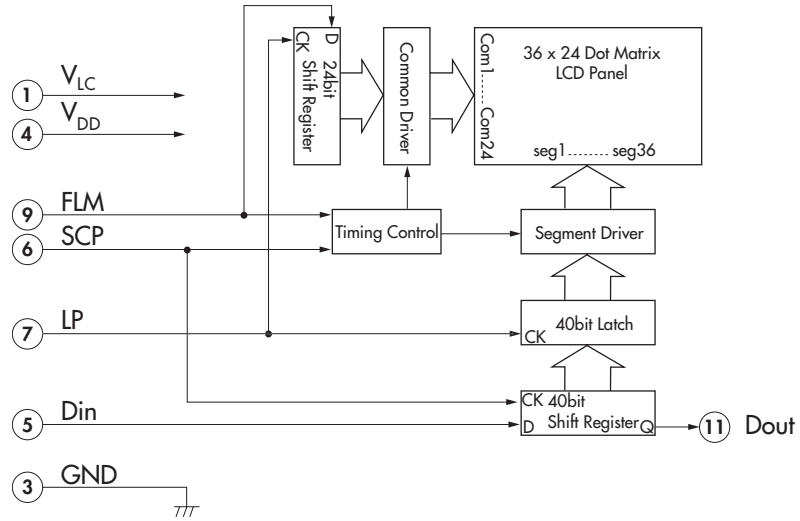

Pin No.	Symbol	Name	Function
①	V <sub>LC</sub>	Power	Power source for LCD drive
②	BL-LED (-)	Terminal of Backlight LED	Cathode for green
③	GND	Ground	
④	V <sub>DD</sub>	Power	Power source for logic circuit
⑤	Din	Data Input	Display serial data bit. Note: to map the display data, because of the difference between the number of internal shift register data (40) and the single line of LCD pixels (36), the first four bits of data shifted will be dummy bits.
⑥	SCP	Serial Clock Pulse	Clock used by 40-bit internal shift register of the switch, shifting the display data bit presented at Din at falling edge.
⑦	LP	Latch Pulse	Line data latch pulse will latch content of internal 40-bit shift register at falling edge for one line of display. LP will also increment the display line by one.
⑧	BL-LED (-)	Terminal of Backlight LED	Cathode for red
⑨	FLM	First Line Marker	The marking signal for the first line data of LCD display. The first line of LCD will be selected by the falling edge of LP signal during the high level (FLM).
⑩	BL-LED (+)	Terminal of Backlight LED	Anode for common
⑪	Dout	Data Output	Display serial output. Can be used to connect to Din of the next SMARTDISPLAY. As a result, many SMARTDISPLAYS can be controlled with one clock and data signal.
⑫	BL-LED (-)	Terminal of Backlight LED	Cathode for blue

## DISTINCTIVE CHARACTERISTICS

### Compact Size

- Perfect for rack mount router and other applications with space limitations.  
Compact body size: 19.0mm (.748") x 18.0mm (.709") compared to Standard body size: 23.13mm (.911") x 20.59mm (.811")
- Vibrant Illumination
- Low Energy Consumption

Programmable LCD

Variety of LED Backlighting Colors

Rubber Dome

Epoxy Sealed Straight PC Terminals

Snap-in standoff for easy, secure mounting and alignment



Programmable to display graphics, alphanumeric characters and animated sequences.

Integrated liquid crystal display provides wide viewing angle with high contrast and clarity.

Viewing area 14.5mm x 11.8mm (horizontal x vertical) at 36 x 24 pixels.

Dome gives crisp tactile feedback to positively indicate circuit transfer.

High reliability and long life of one million actuations minimum.

Epoxy sealed terminals prevent entry of solder flux and other contaminants.

Optional accessories available to simplify production process.

Actual Size

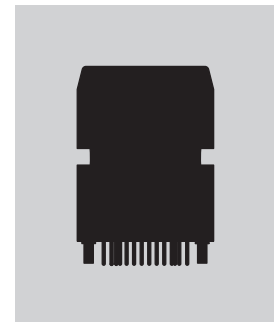

## PART NUMBERS & DESCRIPTIONS

Part Number	Switch Description	LCD Mode	LED Color
<b>IS15BSBFP4RGB</b>	SPST Momentary ON Gold Contacts Straight PC Terminals	Black & White FSTN Positive	* Red/Green/Blue
<b>IS15BSAFP4CF</b>	SPST Momentary ON Gold Contacts Straight PC Terminals	Black & White FSTN Positive	* Red/Green

\* Simultaneous illumination of LEDs achieves infinite colors.

## CHARACTERISTICS OF DISPLAY

Viewing Area	14.5mm x 11.8mm (horizontal x vertical)
Pixel Size	0.371mm x 0.445mm (horizontal x vertical)
Backlight LED	<b>RGB:</b> red/green/blue <b>Bicolor:</b> red/green

### BLOCK DIAGRAM & PIN CONFIGURATIONS FOR RGB



**IS15BSBFP4RGB**  
RGB LED Backlight  
Black and White LCD

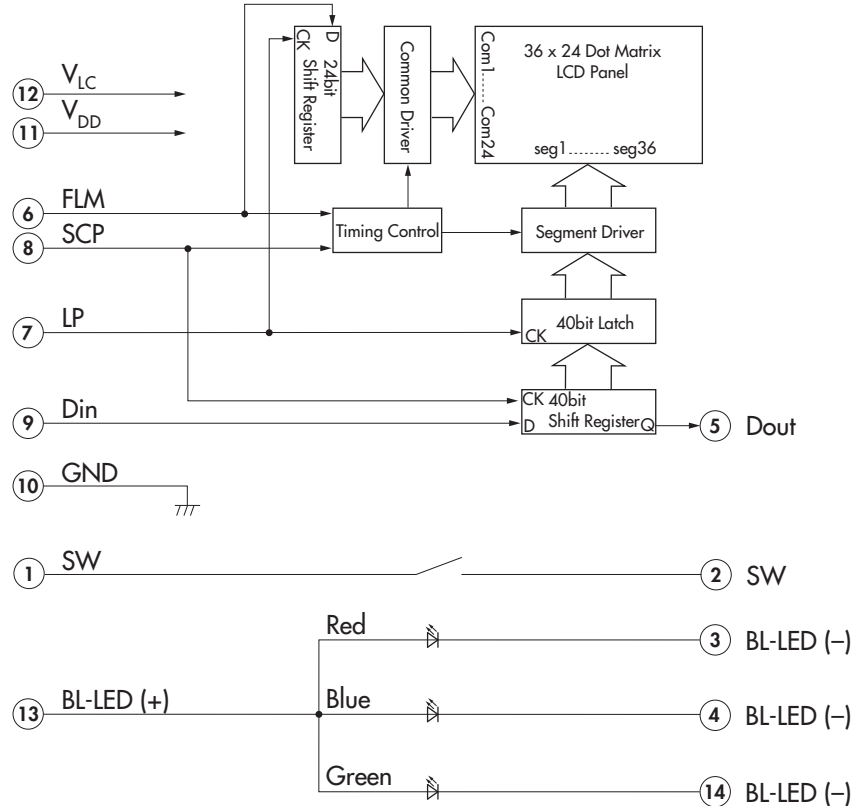

Pin No.	Symbol	Name	Function
①	SW	Terminal of Switch	Normally open
②	SW	Terminal of Switch	Normally open
③	BL-LED (-)	Terminal of Backlight LED	Cathode for red
④	BL-LED (-)	Terminal of Backlight LED	Cathode for blue
⑤	Dout	Data Output	Display serial output. Can be used to connect to Din of the next SMARTSWITCHES. As a result, many SMARTSWITCHES can be controlled with one clock and data signal.
⑥	FLM	First Line Marker	The marking signal for the first line data of LCD display. The first line of LCD will be selected by the falling edge of LP signal during the high level (FLM).
⑦	LP	Latch Pulse	Line data latch pulse will latch content of internal 40-bit shift register at falling edge for one line of display. LP will also increment the display line by one.
⑧	SCP	Serial Clock Pulse	Clock used by 40-bit internal shift register of the switch, shifting the display data bit presented at Din at falling edge.
⑨	Din	Data Input	Display serial data bit. Note: to map the display data, because of the difference between the number of internal shift register data (40) and the single line of LCD pixels (36), the first four bits of data shifted will be dummy bits.
⑩	GND	Ground	
⑪	V <sub>DD</sub>	Power	Power source for logic circuit
⑫	V <sub>LC</sub>	Power	Power source for LCD drive
⑬	BL-LED (+)	Terminal of Backlight LED	Anode for common
⑭	BL-LED (-)	Terminal of Backlight LED	Cathode for green

## BLOCK DIAGRAM & PIN CONFIGURATIONS FOR BICOLOR

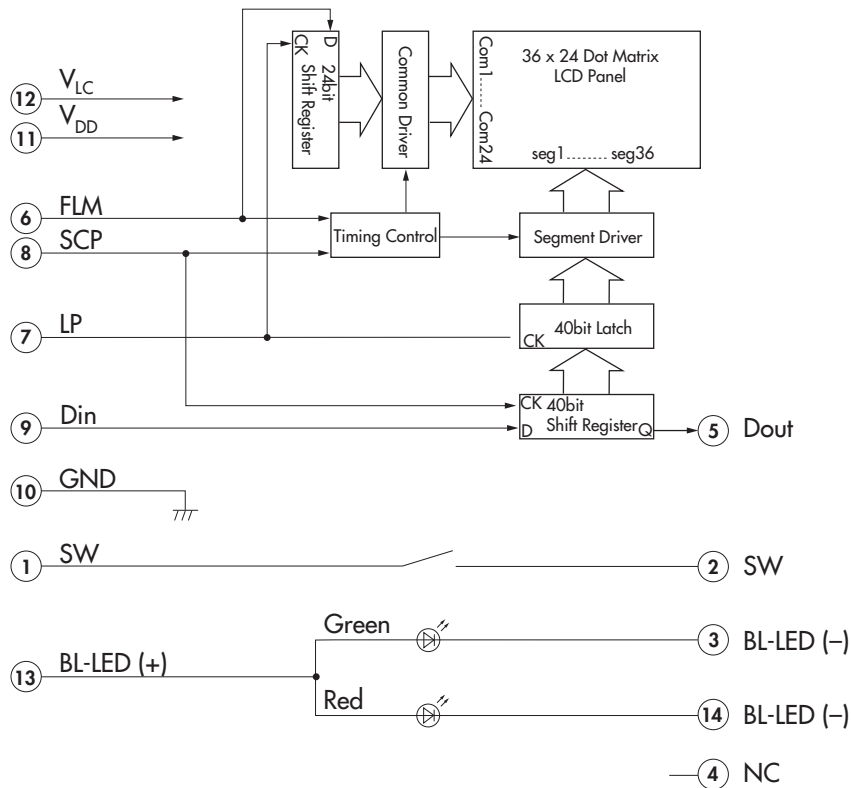

**IS15BSAFP4CF**  
Red/Green LED Backlight  
Black and White LCD

Pin No.	Symbol	Name	Function
①	SW	Terminal of Switch	Normally open
②	SW	Terminal of Switch	Normally open
③	BL-LED (-)	Terminal of Backlight LED	Cathode for green
④	NC	None	No connection
⑤	Dout	Data Output	Display serial output. Can be used to connect to Din of the next SMARTSWITCHES. As a result, many SMARTSWITCHES can be controlled with one clock and data signal.
⑥	FLM	First Line Marker	The marking signal for the first line data of LCD display. The first line of LCD will be selected by the falling edge of LP signal during the high level (FLM).
⑦	LP	Latch Pulse	Line data latch pulse will latch content of internal 40-bit shift register at falling edge for one line of display. LP will also increment the display line by one.
⑧	SCP	Serial Clock Pulse	Clock used by 40-bit internal shift register of the switch, shifting the display data bit presented at Din at falling edge.
⑨	Din	Data Input	Display serial data bit. Note: to map the display data, because of the difference between the number of internal shift register data (40) and the single line of LCD pixels (36), the first four bits of data shifted will be dummy bits.
⑩	GND	Ground	
⑪	V <sub>DD</sub>	Power	Power source for logic circuit
⑫	V <sub>LC</sub>	Power	Power source for LCD drive
⑬	BL-LED (+)	Terminal of Backlight LED	Anode for common
⑭	BL-LED (-)	Terminal of Backlight LED	Cathode for red

### TYPICAL COMPACT SWITCH DIMENSIONS

Terminal numbers are not on the switch.

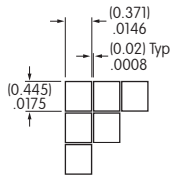
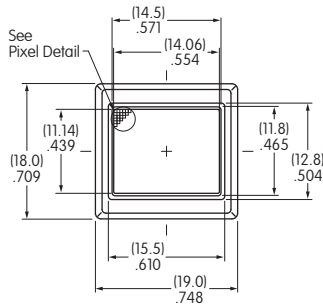

Pixel Detail

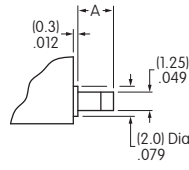
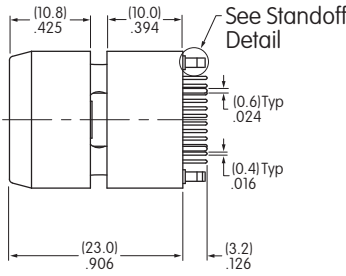

Dimension A  
Standoff 1 = (2.7) .106    Standoff 1 = (2.3) .091

Standoff Detail

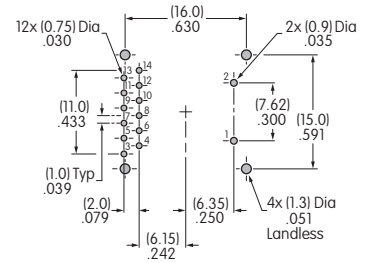
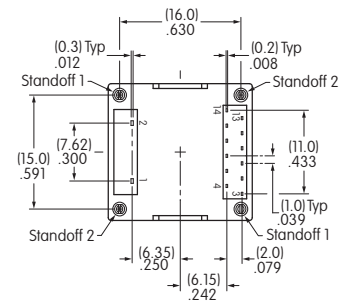

Footprint

### SWITCH SPECIFICATIONS

<b>Circuit</b>	SPST normally open
<b>Electrical Capacity (Resistive Load)</b>	100mA @ 12V DC
<b>Contact Resistance</b>	200 milliohms max @ 20mV 10mA
<b>Insulation Resistance</b>	100 megohms min @ 100V DC
<b>Dielectric Strength</b>	125V AC for 1 minute minimum
<b>Mechanical Endurance</b>	1,000,000 operations minimum
<b>Electrical Endurance</b>	1,000,000 operations minimum
<b>Operating Force</b>	2.2 ± 0.5 Newtons
<b>Total Travel</b>	1.8mm (.071")
<b>Operating Temp. Range</b>	-20°C ~ +60°C (-4°F ~ +140°F)
<b>Storage Temp. Range</b>	-30°C ~ +70°C (-22°F ~ +158°F)

### Optical Characteristics (Temperature at 25°C)

Items	Symbols	Minimum	Typical	Maximum
<b>Contrast Ratio</b>	Cr	—	3.0	—
<b>Viewing Angle (Cr ≥ 1.1)</b>	Up & Down	θ	90°	—
	Right & Left	φ	90°	—



**Absolute Maximum Ratings** (Temperature at 25°C)

Items	Symbols	Ratings
Supply Voltage for Logics	$V_{DD}$	-0.3V to +7.0V
Supply Voltage for LCD	$V_{LC}$	-0.3V to +12.0V
Input Voltage	$V_I$	-0.3V to $V_{DD}$ +0.3V
Output Voltage	$V_O$	-0.3V to $V_{DD}$ +0.3V

**LCD SPECIFICATIONS****Characteristics of Display**

Display Operation Mode	FSTN positive
Display Condition	Transflective with built-in LED backlight
Viewing Angle	6 o'clock
Driving Method	1/24 duty, 1/5 bias (built-in driving circuit)
Pixel Format	36 x 24 pixels (horizontal x vertical)
Backlight LED	<b>RGB:</b> red/green/blue <b>Bicolor:</b> red/green

**Recommended Operating Conditions** (Temperature at 25°C)

Items	Symbols	Minimum	Typical	Maximum
Supply Voltage for Logics	$V_{DD}$	4.5V	5.0V	5.5V
Supply Voltage	$V_{LC}$	7.1	7.3V	7.5
Input Voltage	$V_I$	0V	—	$V_{DD}$
Driving Frequency	$f_{FLM}$	—	150Hz	—
Clock Operation Frequency	$f_{SCP}$	—	—	6.0MHz

**DC Characteristics of LCD Drive** (Temperature at -20°C to +60°C and  $V_{DD} = 5.0V \pm 10\%$ )

Items	Symbols	Test Conditions	Minimum	Typical	Maximum	Unit
High Level Input Voltage	$V_{IH}$		$0.7V_{DD}$		$V_{DD}$	V
Low Level Input Voltage	$V_{IL}$		0		$0.3V_{DD}$	V
High Level Input Leakage Current	$I_{LIH}$	$V_I = V_{DD}$			10	$\mu A$
Low Level Input Leakage Current	$I_{LIL}$	$V_I = 0V$			10	$\mu A$
High Level Output Voltage	$V_{OH}$	$I_{OH} = -500\mu A$	$V_{DD}-0.5$			V
Low Level Output Voltage	$V_{OL}$	$I_{OL} = 500\mu A$			0.5	V
High Level Output Leakage Current	$I_{LOH}$	$V_O = V_{DD}$			10	$\mu A$
Low Level Output Leakage Current	$I_{LOL}$	$V_O = 0V$			10	$\mu A$
Supply Current	$I_{DD}$	$f_{SCP} = 1.0MHz$			500	$\mu A$
LCD Drive Current	$I_{LC}$	$f_{LP} = 2.4kHz$ $V_{LC} = 7.3V$		500	2,000	$\mu A$

### Timing Characteristics of LCD Drive IC

(Temperature at  $-20^{\circ}\text{C}$  to  $+60^{\circ}\text{C}$  and  $V_{DD} = 5.0\text{V} \pm 10\%$ )

Items	Symbols	Minimum	Maximum
Clock Operation Frequency	$f_{SCP}$		6.0MHz
Latch Pulse Frequency	$f_{LP}$		50kHz
Clock High Level Pulse Width	$t_{CWH}$	70ns	
Clock Low Level Pulse Width	$t_{CWL}$	70ns	
Data Setup Time	$t_{DSD}$	45ns	
Data Hold Time	$t_{DHD}$	50ns	
Data Output Delay Time	$t_{PDO}$		25ns
Latch Setup Time	$t_{DSL}$	50ns	
Latch Hold Time	$t_{DHL}$	50ns	
Latch High Level Width	$t_{LWH}$	200ns	
FLM Setup Time	$t_{DSF}$	50ns	
FLM Hold Time	$t_{DHF}$	50ns	
SCP, LP Rise/Fall Time	$t_r/t_f$		15ns

### Timing Diagram

- \*1 Last data on first line
- \*2 Beginning data on second line
- \*3 Location of LP signal on first line

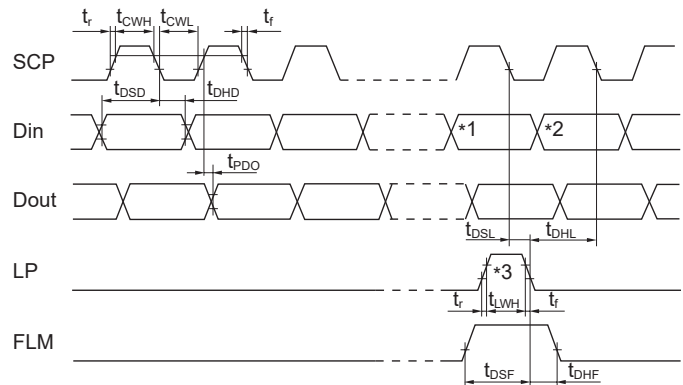

## LED CHARACTERISTICS

### Typical Electrical Characteristics (Temperature at $25^{\circ}\text{C}$ )

Backlight Color	Symbols	Red	Green	Blue	Red/Green	Unit
Forward Current	$I_F$	10	8.5	8.0	15/15	mA

## ABSOLUTE MAXIMUM FOR LEDS

### Electrical Characteristics (Temperature at $25^{\circ}\text{C}$ )

Backlight Color	Symbols	Red	Green	Blue	Red/Green	Unit
Forward Current	$I_F$	20	20	20	20	mA
Forward Voltage	$V_F$	2.0 ( $I_F = 10\text{mA}$ )	2.8 ( $I_F = 8.5\text{mA}$ )	2.8 ( $I_F = 8.0\text{mA}$ )	1.9/1.9	V
Reverse Voltage	$V_R$	4.0	4.0	4.0	4.0	V
Current Reduction Rate Above $25^{\circ}\text{C}$	$\Delta I_F(\text{DC})$	-0.33	-0.33	-0.33	-0.26	mA/ $^{\circ}\text{C}$
*Power Dissipation (LED Overall 115mW)	$P_D$	40	60	60	130 maximum	mW

\*For uniform light emission, Power Dissipation should not exceed the Absolute Maximum Rating, and the Forward Current should not exceed the derated Absolute Forward Current.

## PRECAUTIONS FOR HANDLING &amp; STORAGE OF LCD 36 x 24 DEVICES

## Handling



1. The IS Series devices are electrostatic sensitive.
2. Limit operating force to keytop to 100.0N maximum, as excessive pressure may damage the LCD device.
3. The IS series devices are not process sealed.
4. If the LCD is accidentally broken, avoid contact with the liquid and wash off any liquid spills to the skin or clothing.
5. Clean cap surface with dry cloth. If further cleaning is needed, wipe with dampened cloth using neutral cleanser and dry with clean cloth. Do not use organic solvent.
6. Recommended soldering time and temperature limits:  
Do not exceed 70°C at the LCD level.  
Wave Soldering: see Profile B in the Supplement section.  
Manual Soldering for Switch: see Profile A in the Supplement section.  
Manual Soldering for Display: see Profile B in the Supplement section.
7. Recommendation for backlight color uniformity: Use constant current driver. For current limiting resistor method, the power source should be at least twice the backlight LED forward voltage.
8. The VLC voltage should not be applied before logic voltage. If VLC voltage is present before logic voltage, it may cause the driver logic to freeze and damage the LCD, and the driver logic may become damaged.
9. Backlight Forward Current should not exceed the derated Absolute Maximum Forward Current based on the temperature.
10. Excessive images may result after the same image is emitted continuously for an extended period of time.

## Storage

1. Store in original container and away from direct sunlight.
2. Keep away from static electricity.
3. Avoid extreme temperatures, high humidity, gaseous substances, and all forms of chemical contamination.

### OPTIONAL ACCESSORIES

#### AT548 Panel Mount Housing

Material: Polyamide

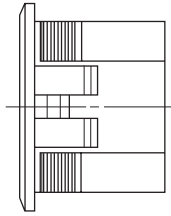

#### Compatible Part Numbers for AT548

##### Wide View LCD 36 x 24

IS15BAFP4CF

IS15BBFP4RGB

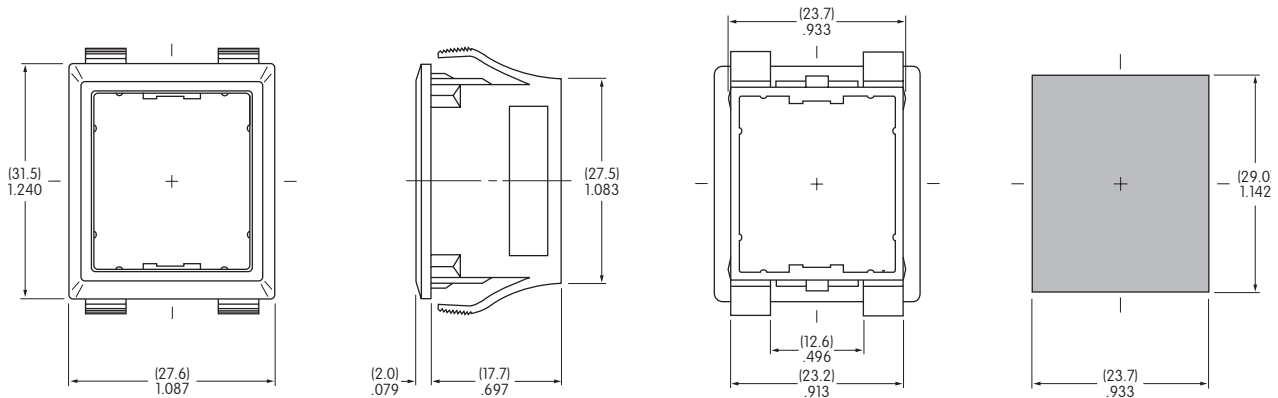

The Panel Mount Housing is available for the LCD 36 x 24 Pushbutton only.

Panel Thickness Range:  
(1.5 ~ 4.0mm) .059 ~ .157"

Panel mount housing allows the LCD 36 x 24 Pushbutton to be snapped into a panel cutout for quick, secure mounting. It gives flexibility in locating the devices anywhere on the panel. It also allows using the LCD 36 x 24 Pushbutton on an existing panel.

#### AT542 Coupler

Material: PBT

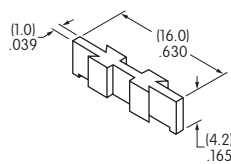

#### Compatible Part Numbers for AT542

##### Wide View LCD 36 x 24

IS15BAFP4CF

IS15BBFP4RGB

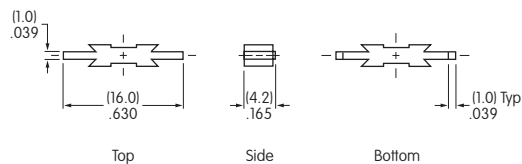

This coupler is for connecting the LCD 36 x 24 Pushbutton into precise, tight groupings that maintain an even distance from PCB to top of the actuator.

The Coupler is available for the LCD 36 x 24 Pushbutton only.

Toggles  
Rockers  
Pushbuttons  
Illuminated PB  
Programmable E  
Keylocks  
Rotaries  
Slides  
Tactiles  
Tilt  
Touch  
Indicators  
Accessories  
Supplement

## OPTIONAL ACCESSORIES

### AT9704-02YC Socket for Single and Bicolor LCD 36 x 24 Pushbutton

Materials:

Base - Glass Fiber Reinforced PBT

Terminals - Brass/Beryllium Copper

- The socket permits the SmartSwitch to be plugged in after automated processing.
- Use of the socket enables easy field replacement of the device.

Compatible Part Number for AT9704-02YC

Wide View LCD 36 x 24

IS15BAFP4CF

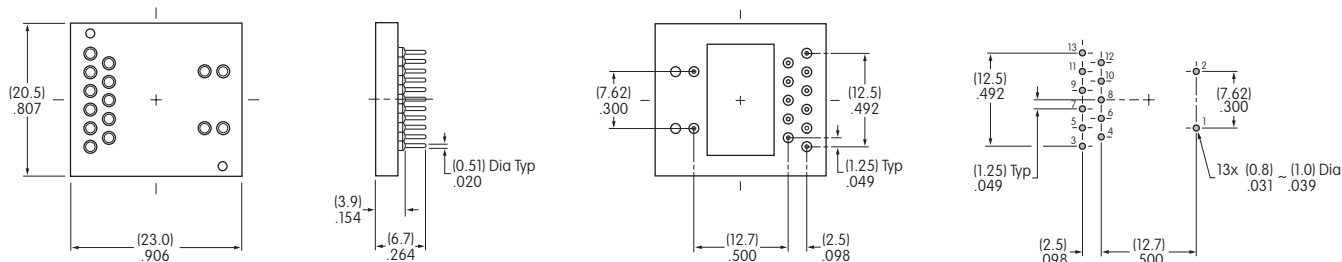

### AT9704-065E Socket for RGB LCD 36 x 24 Pushbutton

Materials:

Base - Glass Fiber Reinforced PBT

Terminals - Brass/Beryllium Copper

- The socket permits the RGB SmartSwitch to be plugged in after automated processing.
- Use of the socket enables easy field replacement of the device.

Compatible Part Number for AT9704-065E

Wide View RGB LCD 36 x 24

IS15BBFP4RGB

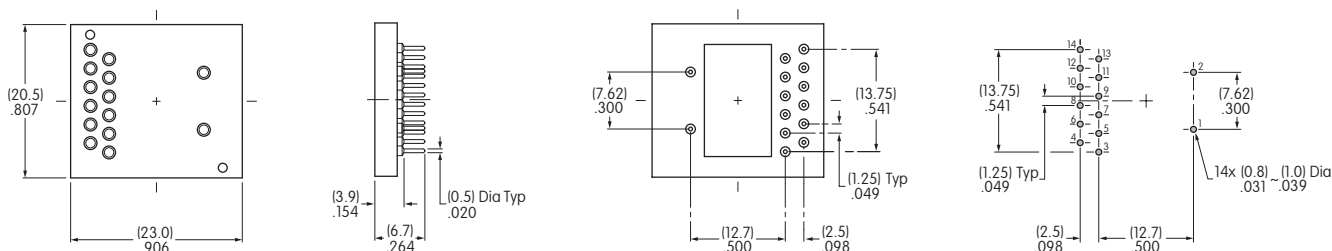

### AT9704-065F Socket for Compact Pushbutton (All Models)

Materials:

Base - Glass Fiber Reinforced PBT

Terminals - Brass/Beryllium Copper

- The socket permits the Compact SmartSwitch to be plugged in after automated processing.
- Use of the socket enables easy field replacement of the device.

Compatible Part Numbers for AT9704-065F

Wide View/Short Travel LCD 64 x 32

IS15EBFP4RGB-09YN

Wide View LCD 64 x 32 Compact

IS15ESBFP4RGB

Wide View LCD 36 x 24

IS15BAFP4CF

Wide View LCD 36 x 24 Compact

IS15BSBFP4RGB

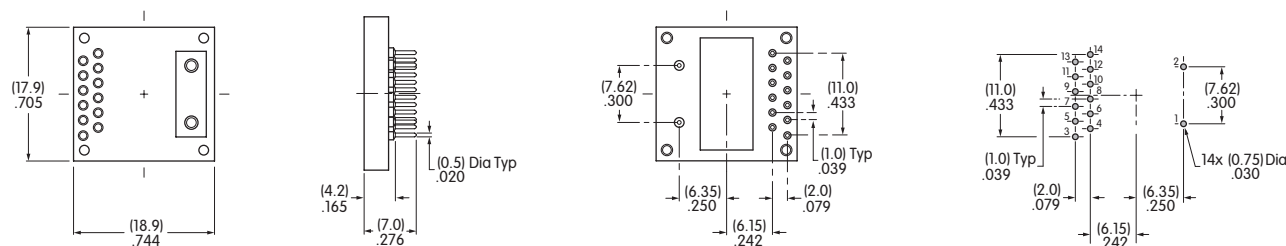

Note: AT9704-065F Socket may be used with the LCD 64 x 32 SmartSwitch by removing pins 3, 4, 11, 12, 13 and 14.

### OPTIONAL ACCESSORIES

#### AT9704-085K Socket for LCD 64 x 32 Pushbutton

Materials:

Base - Glass Fiber Reinforced PBT

Terminals - Brass/Beryllium Copper

Compatible Part Number for AT9704-085K

Wide View LCD 64 x 32

IS15EBFP4RGB

- The socket permits the SmartSwitch to be plugged in after automated processing.
- Use of the socket enables easy field replacement of the device.

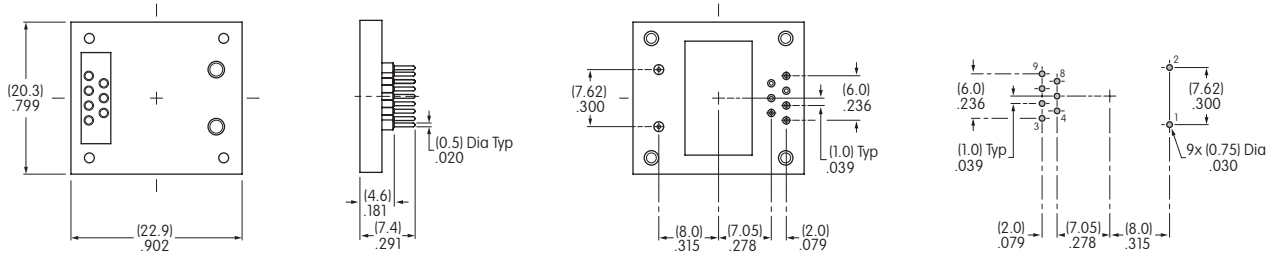

#### AT9704-085L Socket for OLED Pushbutton

Materials:

Base - Glass Fiber Reinforced PBT

Terminals - Brass/Beryllium Copper

Compatible Part Numbers for AT9704-085L

OLED Pushbutton

Frameless OLED

ISC15ANP4

ISF15ACP4

- The socket permits the OLED SmartSwitch to be plugged in after automated processing.
- Use of the socket enables easy field replacement of the device.

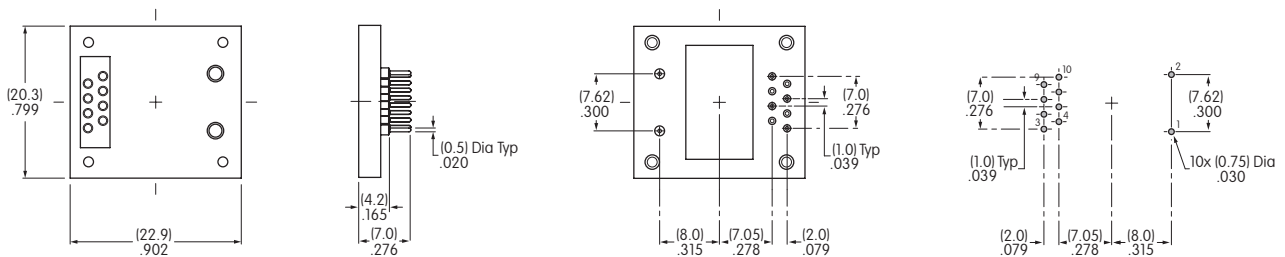

#### AT9704-085M Socket for OLED Display

Materials:

Base - Glass Fiber Reinforced PBT

Terminals - Brass/Beryllium Copper

Compatible Part Number for AT9704-085M

OLED Display

ISC01P

- The socket permits the OLED SmartDisplay to be plugged in after automated processing.
- Use of the socket enables easy field replacement of the device.

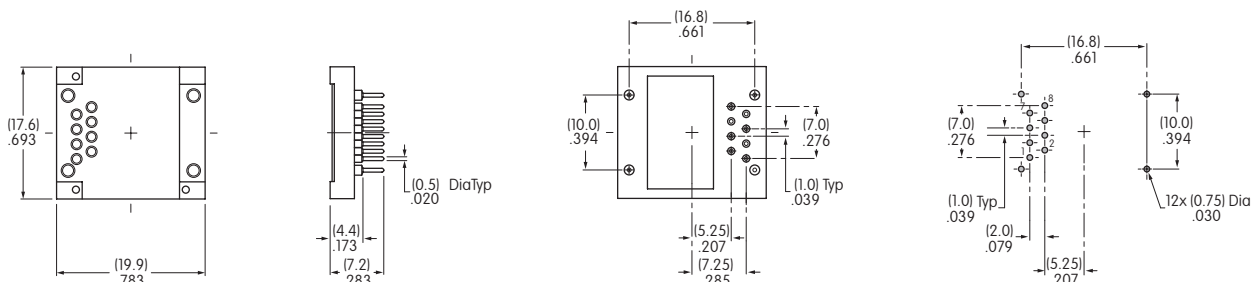



Toggles

Rockers

Pushbuttons

Illuminated PB

Programmable

Keylocks

F

Rotaries

Slides

Tactiles

Tilt

Touch

Indicators

Accessories

Supplement



### CK Series .....F3

16mm & 19mm High Security  
3A Power Level  
Solder Lug  
Bushing Mount



### SK Series .....F9

12mm Low & Medium Security  
3A & 1A Power Level  
Solder Lug  
Bushing Mount



### SK Series .....F15

Antistatic Process Sealed Subminiature  
0.4VA Logic Level  
Straight & Right Angle PC  
PCB Mount



### SK Series .....F19

Process Sealed  
0.4VA Logic Level  
Straight & Right Angle PC  
PCB Mount



### SK Series .....F25

Antistatic Snap-in  
0.4VA Logic Level  
Solder Lug  
Snap-in Mount



# General Specifications

## Electrical Capacity (Resistive Load)

Power Level: 3A @ 250V AC

## Other Ratings

**Contact Resistance:** 20 milliohms maximum  
**Insulation Resistance:** 1,000 megohms minimum @ 500V DC  
**Dielectric Strength:** 1,000V AC minimum between contacts for 1 minute minimum;  
 1,500V AC minimum between contacts & case for 1 minute minimum  
**Mechanical Life:** 30,000 cycles minimum  
**Electrical Life:** 10,000 cycles minimum  
**Static Capability:** Withstands 15 kilovolts minimum ESD minimum (for CKM models only)  
**Nominal Operating Torque:** 16mm Bushing (CKM models):  
 .04 mNm (5.67 oz•in) for Flat Key  
 .08 mNm (11.33 oz•in) for Tubular Key  
 19mm Bushing (CKL models):  
 .05 mNm (7.08 oz•in) for Flat Key  
 .07 mNm (9.91 oz•in) for Tubular Key  
**Contact Timing:** Break-before-make  
**Angle of Throw:** 90° for 2-position & 45° for 3-position

## Materials & Finishes

**Keys for CKM:** Brass with nickel plating with ABS handle  
**Keys for CKL:** Brass with nickel plating for tubular key;  
 brass with chrome plating for flat key  
**Housing/Bushing:** Glass fiber reinforced PBT for CKM models;  
 zinc alloy with chrome plating for CKL  
**Base:** LCP (Liquid Crystal Polymer)  
**Contact Terminals:** Copper with silver plating  
**Common Terminals:** Copper with silver plating  
**Movable Contactor:** Copper  
**Movable Contacts:** Silver

## Environmental Data

**Operating Temperature Range:** -25°C through +70°C (-13°F through +158°F)  
**Humidity:** 90 ~ 95% humidity for 240 hours @ 40°C (104°F) for CKM;  
 90 ~ 95% humidity for 96 hours @ 40°C (104°F) for CKL  
**Vibration:** 10 ~ 55Hz with peak-to-peak amplitude of 1.5mm for CKM or 0.7mm for CKL traversing the  
 frequency range & returning in 1 minute; 3 right angled directions for 2 hours  
**Shock:** 50G (490m/s<sup>2</sup>) acceleration for CKM; 30G (294m/s<sup>2</sup>) acceleration for CKL; (CKM & CKL tested  
 in 6 right angled directions, with 5 shocks in each direction)

## Installation

**Mounting Torque:** 1.5 Nm (13.28 lb•in) maximum  
**Soldering Time & Temperature:** Manual Soldering: See Profile A in Supplement section.

Toggle

Rockers

Pushbuttons

Illuminated PB

Programmable

**F**  
Keylocks

Rotaries

Slides

Tactiles

Tilt

Touch

Indicators

Accessories

Supplement

# Distinctive Characteristics

High insulating material for 16mm CKM models withstands over 15 kilovolts of electrostatic discharge, thus providing antistatic feature.

Rugged, die cast housing 19mm CKL models designed for higher security requirements.

Vertically rotating switching mechanism combines with self-cleaning sliding contacts for high reliability and long operating life.

16mm and 19mm diameter bushings available.

CKL and CKM on-off-on models with tubular keys have push-and-lock mechanism which allows contactor to drop and slide over stationary contacts.

Available in both flat and tubular key styles; flat key is reversible for easier setting.

Epoxy sealed terminals prevent entry of flux and other contaminants.

Interior construction provides seal for contact area.

High dielectric strength of 1,500 volts between contacts and case.

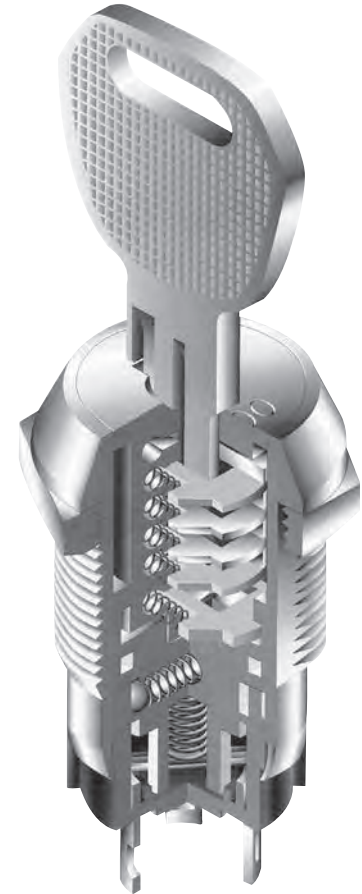

Actual Size CKM with Tubular Key

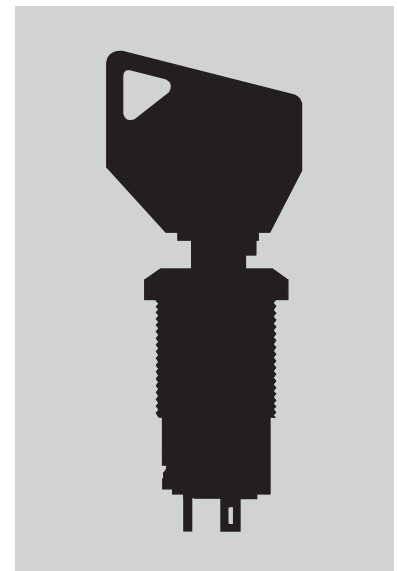

Toggles

Rockers

Pushbuttons

Illuminated PB

Programmable

Keylocks

Rotaries

Slides

Tactiles

Tilt

Touch

Indicators

Accessories

Supplement

## TYPICAL SWITCH ORDERING EXAMPLE

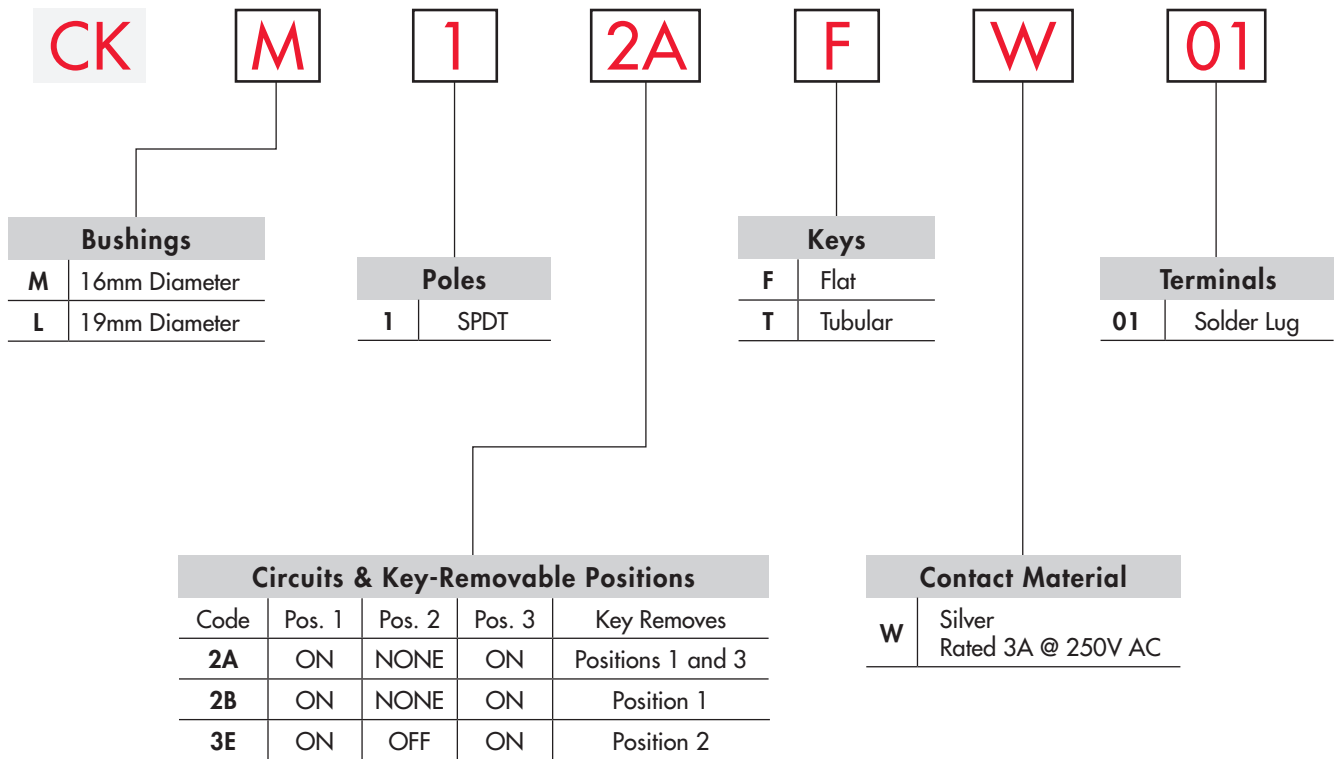

### DESCRIPTION FOR TYPICAL ORDERING EXAMPLE

**CKM12AFW01**

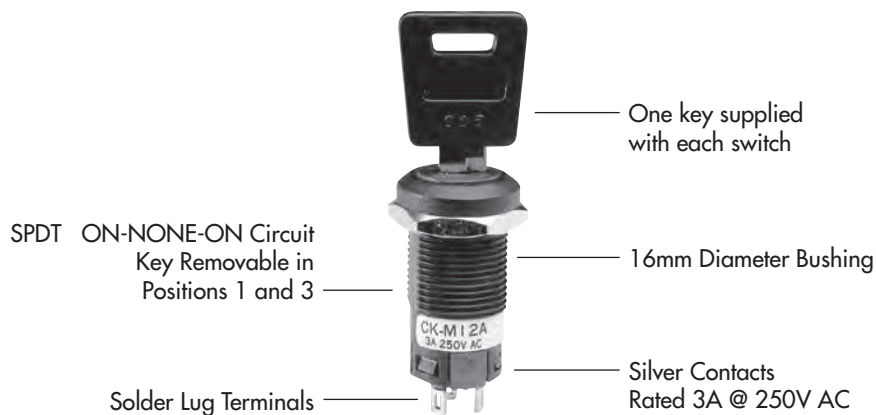

## POLES, CIRCUITS & KEY-REMOVABLE POSITIONS

Pole & Throw	Model	Key Positions			Connected Terminals (Terminal numbers are on switch)			Schematic	⊙ = Key Removable ● = Not Removable ✓ = Maximum Arc
		Pos 1	Pos 2	Pos 3	Pos 1	Pos 2	Pos 3		
SPDT	CKM12A CKL12A	ON	NONE	ON	COM-1	—	COM-2		
SPDT	CKM12B CKL12B	ON	NONE	ON	COM-1	—	COM-2		
SPDT	CKM13E CKL13E	ON	OFF	ON	COM-1	OPEN	COM-2		

## KEYS

### F Flat Key

- AT4147 for CKM 16mm**  
Brass with Nickel Plating key base & ABS key handle
- AT4153 for CKL 19mm**  
Brass with Chrome Plating (crosshatch texture on handle)

One key provided with each switch (no master key available)  
For ordering additional keys, indicate the same key number that is engraved on the face of your switch.

Randomly assigned key number (001 through 010 for CKM models & 001 through 025 for CKL models).

Typical Key Ordering Example: AT4153-001

### T Tubular Key (must be pressed inward to actuate)

- AT4146 for CKM 16mm**  
Brass with Nickel Plating key base & ABS key handle
- AT4152 for CKL 19mm**  
Brass with Nickel Plating (smooth)

One key provided with each switch (no master key available)  
For ordering additional keys, indicate the same key number that is engraved on the face of your switch.

Randomly assigned key number (001 through 025 for CKM models & 001 through 050 for CKL models).

Typical Key Ordering Example: AT4146-001

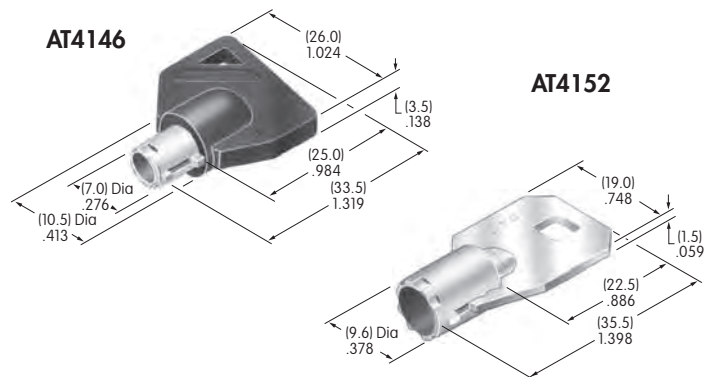
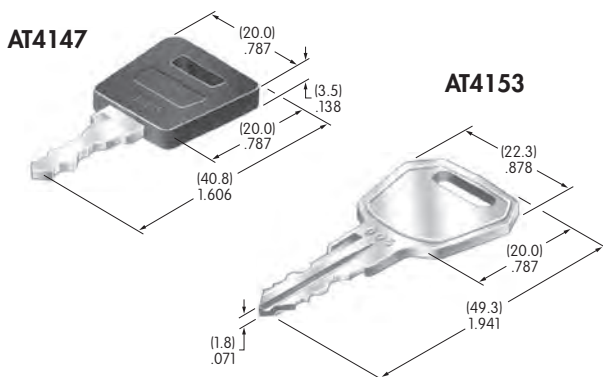

## CONTACT MATERIALS, RATINGS & TERMINALS

**W** Silver over Silver  
Power Level 3A @ 250V AC

**01** Solder Lug Terminals

Solder Lug Terminal  
for CKM

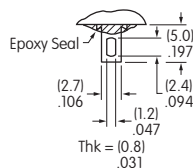

Solder Lug Terminal  
for CKL

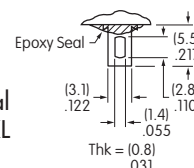

Toggles  
Rockers  
Pushbuttons  
Illuminated PB  
Programmable  
Keylocks  
Rotaries  
Slides  
Tactiles  
Tilt  
Touch  
Indicators  
Accessories  
Supplement

## TYPICAL SWITCH DIMENSIONS

**90°  
Angular  
Throw**

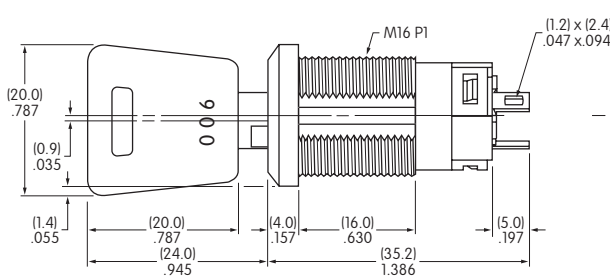
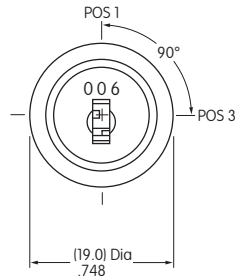

**16mm Bushing • Flat Key**

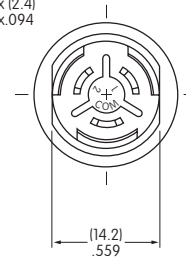

**CKM12AFW01**

**45°  
Angular  
Throw**

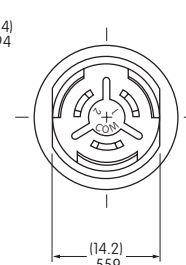
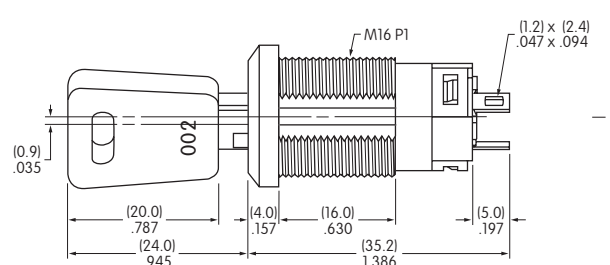
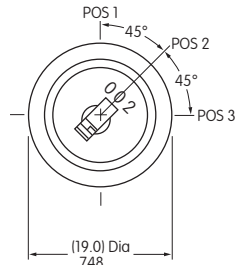

Toggles  
Rockers  
Pushbuttons  
Illuminated PB  
Programmable  
**F** Keylocks

**90°  
Angular  
Throw**

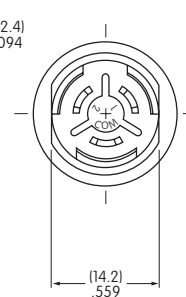
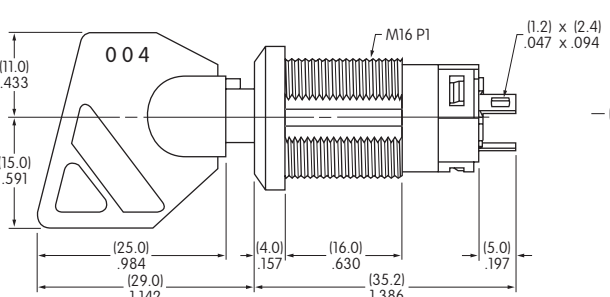
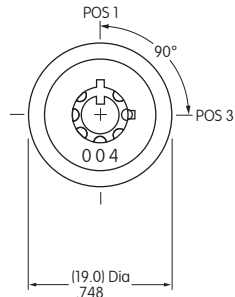

**CKM13ETW01**

**45°  
Angular  
Throw**

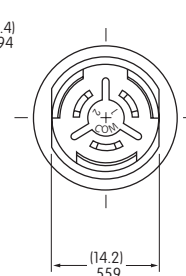
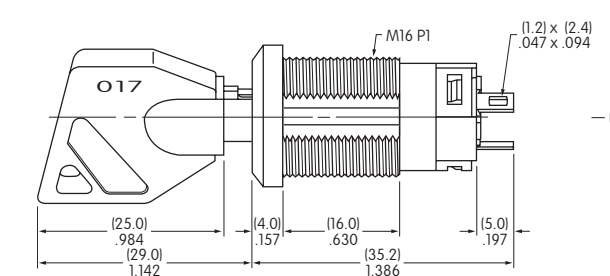
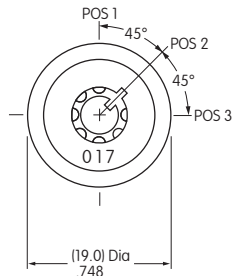

Rotaries  
Slides  
Tactiles  
Tilt  
Touch

## PANEL CUTOUT & STANDARD HARDWARE FOR 16MM BUSHING

Maximum Effective  
Panel Thickness:  
.469" (11.9mm)

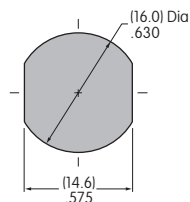

**AT016**  
**16mm Hex Mounting Nut**  
**for CKM**

1 included with each switch  
Steel with nickel plating

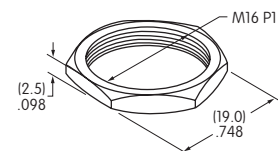

Indicators  
Accessories  
Supplement

## TYPICAL SWITCH DIMENSIONS

### 19mm Bushing • Flat Key



**90° Angular Throw**

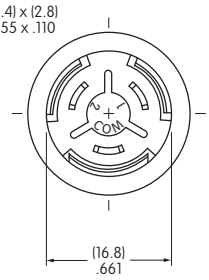
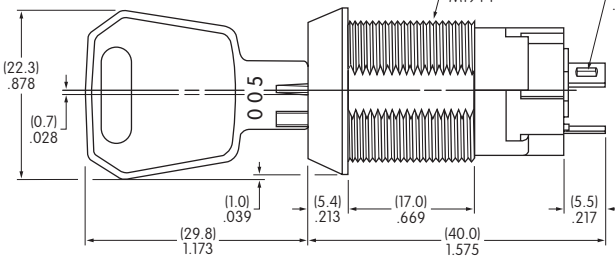
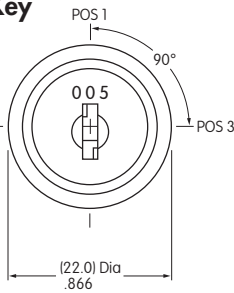

**45° Angular Throw**

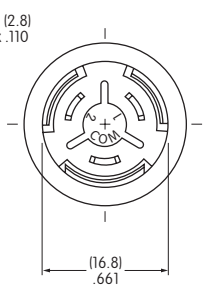
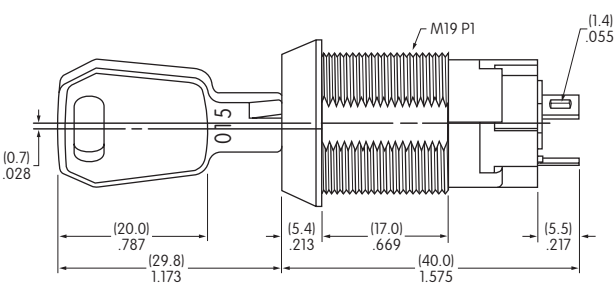
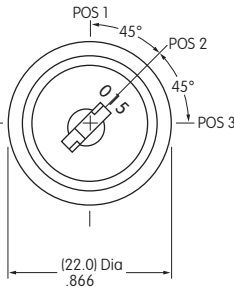

**CKL12AFW01**

### 19mm Bushing • Tubular Key



**90° Angular Throw**

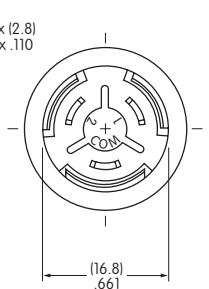
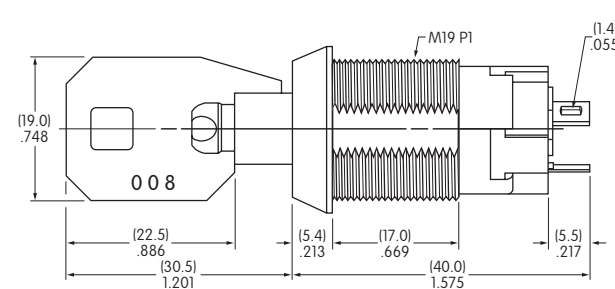
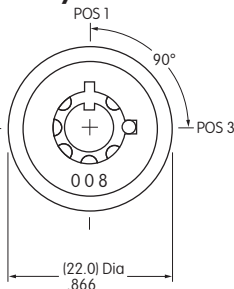

**45° Angular Throw**

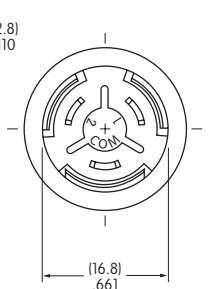
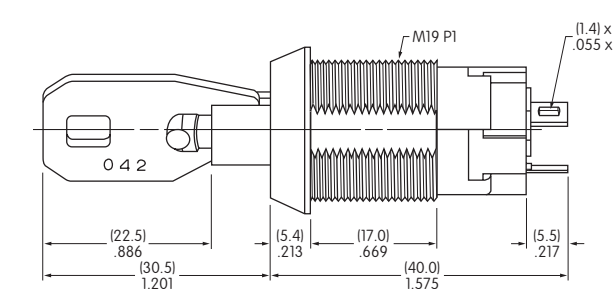
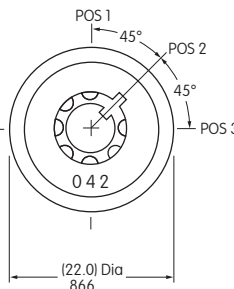

**CKL13ETW01**

## PANEL CUTOUT & STANDARD HARDWARE FOR 19MM BUSHING

Maximum Effective Panel Thickness: .496" (12.6mm)

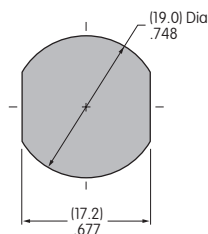

**AT019**  
19mm Hex Mounting Nut for CKL

1 included with each switch  
Steel with nickel plating

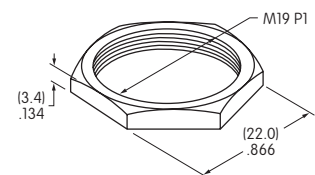

# General Specifications

## Electrical Capacity (Resistive Load)

**Power Level (silver):** 3A @ 125V AC for low & medium security; 1A @ 250V AC for low security

## Other Ratings

**Contact Resistance:** 10 milliohms maximum  
**Insulation Resistance:** 1,000 megohms minimum @ 500V DC  
**Dielectric Strength:** 1,000V AC minimum between contacts for 1 minute minimum;  
 1,500V AC minimum between contacts & case for 1 minute minimum  
**Mechanical Life:** 30,000 cycles minimum  
**Electrical Life:** 10,000 cycles minimum  
**Nominal Operating Torque:** .026Nm (.234 lb•in) for low & medium security  
**Contact Timing:** Break-before-make  
**Angle of Throw:** 90° for 2-position & 45° for 3-position

## Materials & Finishes

**Key:** Zinc alloy with chrome plating (matte) for low security models;  
 brass with nickel plating (shiny) for medium security models  
**Tumbler Barrel:** Zinc alloy with chrome plating (matte) for low security models;  
 zinc alloy with chrome plating (shiny) for medium security models  
**Housing/Bushing:** Zinc alloy with chrome plating (matte) for low security models;  
 zinc alloy with chrome plating (shiny) for medium security models  
**Base:** Phenolic resin (thermoset)  
**Movable Contactor:** Silver  
**Stationary Contacts:** Silver capped copper with silver plating  
**Terminals:** Copper or brass with silver plating

## Environmental Data

**Operating Temperature Range:** -25°C through +70°C (-13°F through +158°F)  
**Humidity:** 90 ~ 95% humidity for 96 hours @ 40°C (104°F)  
**Vibration:** 10 ~ 55Hz with peak-to-peak amplitude of 1.5mm traversing the frequency range & returning in 1 minute; 3 right angled directions for 2 hours  
**Shock:** 50G (490m/s<sup>2</sup>) acceleration (tested in 6 right angled directions, with 5 shocks in each direction)

## Installation

**Mounting Torque:** 1.5Nm (13.28 lb•in) maximum  
**Soldering Time & Temperature:** Manual Soldering: See Profile A in Supplement section.

## Standards & Certifications

**UL:** **File No. E44145 - Recognized only when ordered with marking on switch.**  
 Add "/U" or "/CUL" to end of part number to order UL recognized switch.  
 All low security models recognized at 3A @ 125V AC or 1A @ 250V AC  
 & all medium security models recognized at 3A @ 125V AC  
**CSA:** **File No. 023535\_0\_000 - Certified only when ordered with marking on switch.**  
 Add "/C" to end of part number to order CSA certified switch.  
 All low security models certified at 3A @ 125V AC or 1A @ 250V AC

# Distinctive Characteristics

12mm diameter bushing for easy panel cutout preparation and high density mounting.

Epoxy sealed terminals prevent entry of flux and other contaminants.

Short behind panel dimension - only 1.063" (27.0mm).

High dielectric strength of 1,500 volts between contacts and case.

Detent mechanism gives crisp, positive action for accurate switch setting.

Dust resistant interior construction protects contacts.

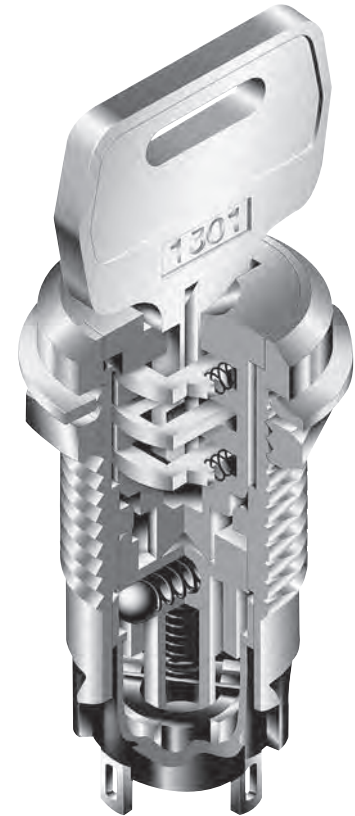

Actual Size

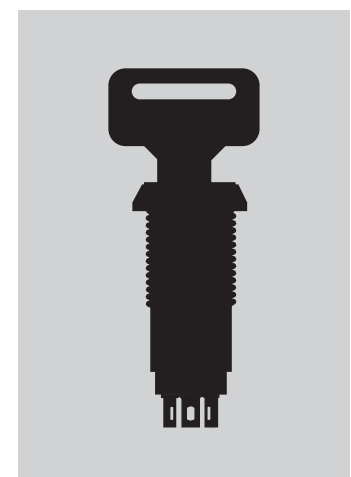



TYPICAL SWITCH ORDERING EXAMPLE

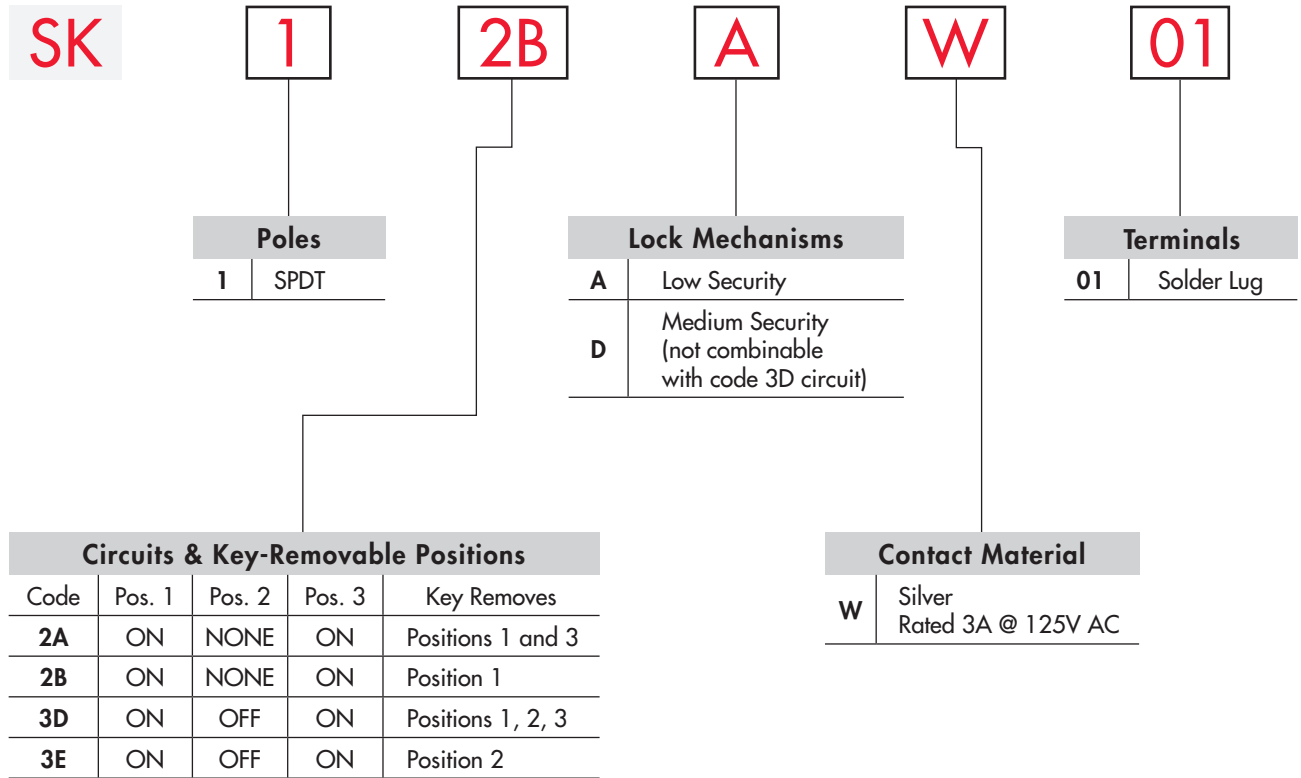

**IMPORTANT:**



Switches are supplied without UL, cULus & CSA marking unless specified. **UL, cULus & CSA recognized only when ordered with marking on the switch.** Specific models, ratings, & ordering instructions are noted on the General Specifications page.

DESCRIPTION FOR TYPICAL ORDERING EXAMPLE

**SK12BAW01**



### POLES, CIRCUITS & KEY-REMOVABLE POSITIONS

Pole & Throw	Model	Key Positions			Connected Terminals (Terminal numbers are on switch)			Schematic	⊙ = Key Removable ● = Not Removable ✓ = Maximum Arc
		Pos 1	Pos 2	Pos 3	Pos 1	Pos 2	Pos 3		
SPDT	SK12A	ON	NONE	ON	COM-1	—	COM-2		
SPDT	SK12B	ON	NONE	ON	COM-1	—	COM-2		
SPDT	*SK13D	ON	OFF	ON	COM-1	OPEN	COM-2		
SPDT	SK13E	ON	OFF	ON	COM-1	OPEN	COM-2		

\* Available with low security only

### KEY REMOVABLE

**A** Positions 1 & 3  
90° Angular Throw

**B** Position 1  
90° Angular Throw

**D** Positions 1, 2 & 3  
45° Angular Throw

**E** Position 2  
45° Angular Throw

### LOCK MECHANISMS & KEYS

**A** Low Security Mechanism

Zinc Alloy with Chrome Plating (matte finish)

Two keys provided with each switch  
(no master key available)

For ordering additional keys:  
AT4081 for SK12A and SK12B, marked "1201"  
AT4082 for SK13D and SK13E, marked "1301"

**D** Medium Security Mechanism

Brass with Nickel Plating (shiny finish)

One key provided with each switch  
(no master key available)

For ordering additional keys, indicate the same key number that is engraved on the face of your switch.

Key numbers (001 through 010) randomly assigned.

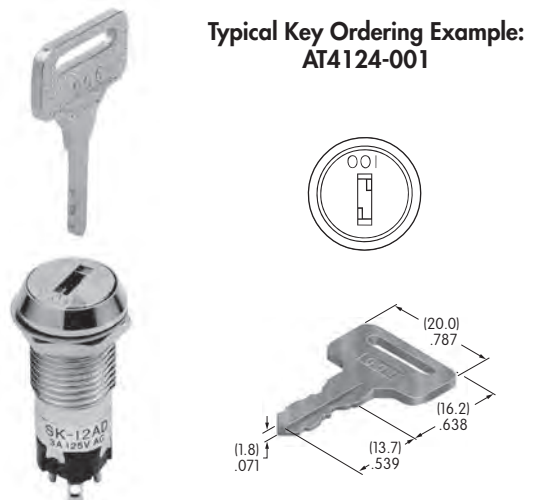
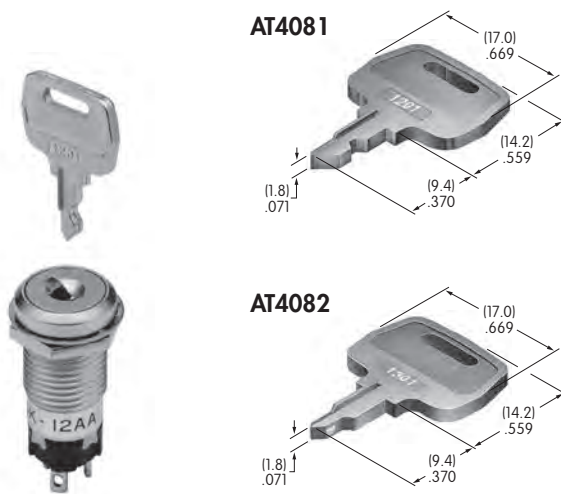

Toggles  
 Rockers  
 Pushbuttons  
 Illuminated PB  
 Programmable  
 Keylocks  
 Rotaries  
 Slides  
 Tactiles  
 Tilt  
 Touch  
 Indicators  
 Accessories  
 Supplement

## CONTACT MATERIALS, RATINGS, & TERMINALS

**W**

Silver over Silver

Power Level

3A @ 125V AC

**01**

Solder Lug Terminals

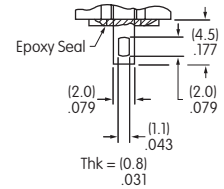

## TYPICAL SWITCH DIMENSIONS

### Low Security • 90° Angular Throw

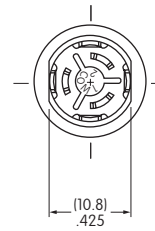
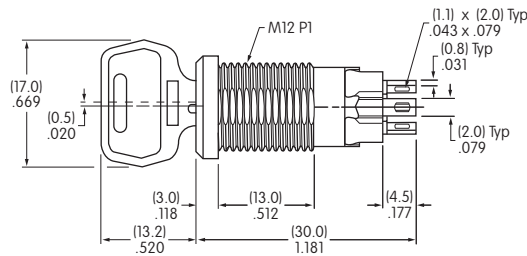
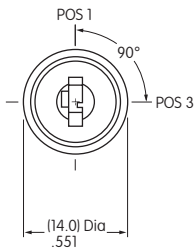

SK12BAW01

### Low Security • 45° Angular Throw

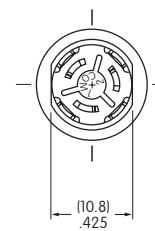
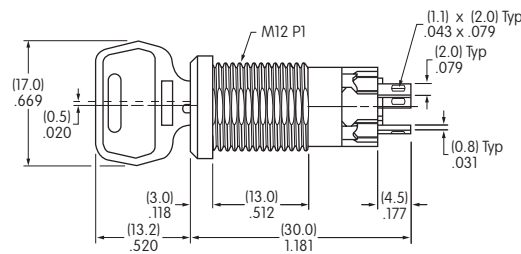
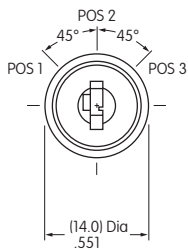

SK13EAW01

### TYPICAL SWITCH DIMENSIONS

#### Medium Security • 90° Angular Throw

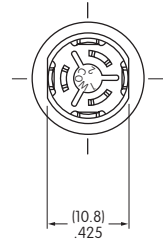
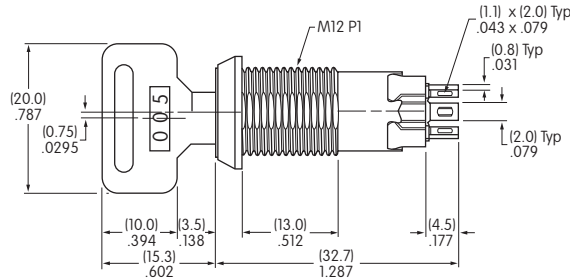
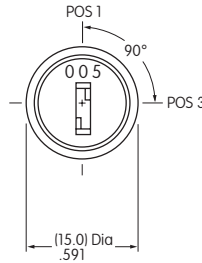

SK12ADW01

#### Medium Security • 45° Angular Throw

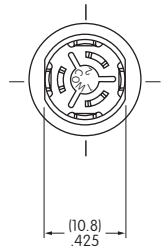
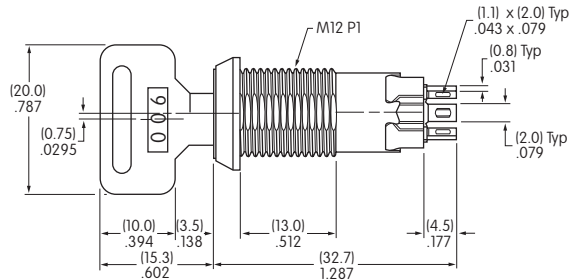
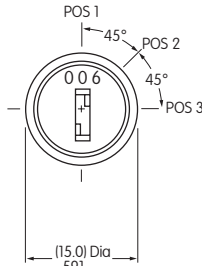

SK13EDW01

### PANEL CUTOUT & THICKNESS

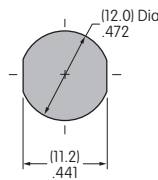

The 12mm bushing is .512" (13.0mm) long. It allows mounting these devices in a maximum effective panel thickness of .315" (8.0mm).

### STANDARD HARDWARE

#### AT527M Hex Mounting Nut

1 included with each switch  
Steel with nickel plating

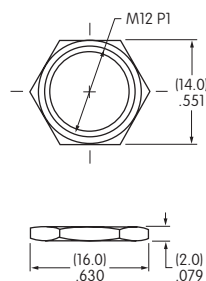

#### AT508 Internal Tooth Lockwasher

1 included with each switch  
Steel with zinc/chromate plating

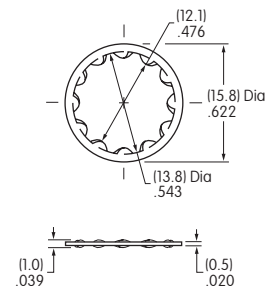

Toggles  
Rockers  
Pushbuttons  
Illuminated PB  
Programmable  
Keylocks  
Rotaries  
Slides  
Tactiles  
Tilt  
Touch  
Indicators  
Accessories  
Supplement

# General Specifications

## Electrical Capacity (Resistive Load)

**Logic Level:** 0.4VA maximum @ 28V AC/DC maximum  
(Applicable Range 0.1mA ~ 0.1A @ 20mV ~ 28V)  
Note: Find additional explanation of operating range in Supplement section

## Other Ratings

**Contact Resistance:** 100 milliohms maximum  
**Insulation Resistance:** 100 megohms minimum @ 500V DC  
**Dielectric Strength:** 500V AC minimum for 1 minute minimum  
**Mechanical Life:** 30,000 cycles minimum  
**Electrical Life:** 20,000 cycles minimum  
**Static Capability:** Withstands 15 kilovolts ESD  
**Nominal Operating Torque:** .0002Nm (.0017 lb•in)  
**Contact Timing:** Break-before-make  
**Angle of Throw:** 45° for 3-position & 5-position

## Materials & Finishes

**Key:** Polyacetal  
**Housing/Bushing:** Glass fiber reinforced polyester (PBT)  
**Base:** Glass fiber reinforced polyamide  
**Rotor & Stopper:** Polyacetal  
**Tumbler Plate:** Brass  
**Movable Contactor:** Beryllium copper with gold plating  
**Stationary Contacts:** Phosphor bronze with gold plating  
**Terminals:** Phosphor bronze with gold plating  
**Mounting Bracket:** Steel with tin plating

## Environmental Data

**Operating Temperature Range:** -25°C through +70°C (-13°F through +158°F)  
**Humidity:** 90 ~ 95% humidity for 240 hours @ 40°C (104°F)  
**Vibration:** 10 ~ 55Hz with peak-to-peak amplitude of 1.5mm traversing the frequency range & returning in 1 minute; 3 right angled directions for 2 hours  
**Shock:** 50G (490m/s<sup>2</sup>) acceleration (tested in 6 right angled directions, with 5 shocks in each direction)

## PCB Processing

**Soldering:** Wave Soldering Recommended. See Profile A in Supplement section.  
Manual Soldering: See Profile A in Supplement section.  
**Cleaning:** Automated cleaning. See Cleaning specifications in Supplement section.

## Standards & Certifications

The SK Series devices have not been tested for UL recognition or CSA certification. These switches are designed for use in a low-voltage, low-current, logic-level circuit. When used as intended in a logic-level circuit, the results do not produce hazardous energy.

# Distinctive Characteristics

Housing and bushing of high insulating material withstands over 15 kilovolts of electrostatic discharge, thus providing antistatic protection.

Totally sealed construction with internal o-ring, with gasket between base and housing, and with insert-molded terminals, gives protection for automated processing techniques.

Subminiature size allows high density mounting.

Molded-in terminals prevent entry of flux and other contaminants.

Crimped bracket legs ensure secure PCB mounting and prevent dislodging during automated wave soldering.

Bifurcated, self-wiping contact mechanism provides unequalled logic-level reliability and smoother, positive detent actuation.

Detent mechanism, with its spring-operated steel ball, gives distinct feel and crisp actuation for accurate switch setting.

.100" x .100" (2.54mm x 2.54mm) terminal spacing conforms to standard PC board grid spacing.

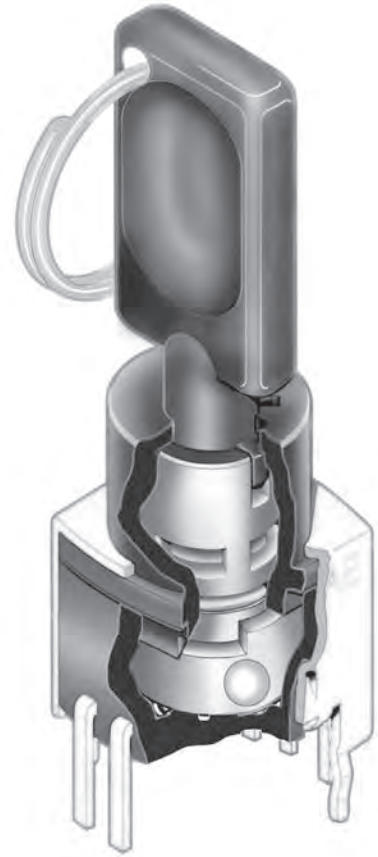

Actual Size

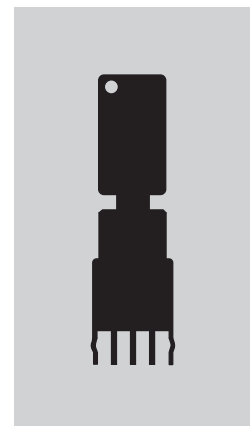

TYPICAL SWITCH ORDERING EXAMPLE

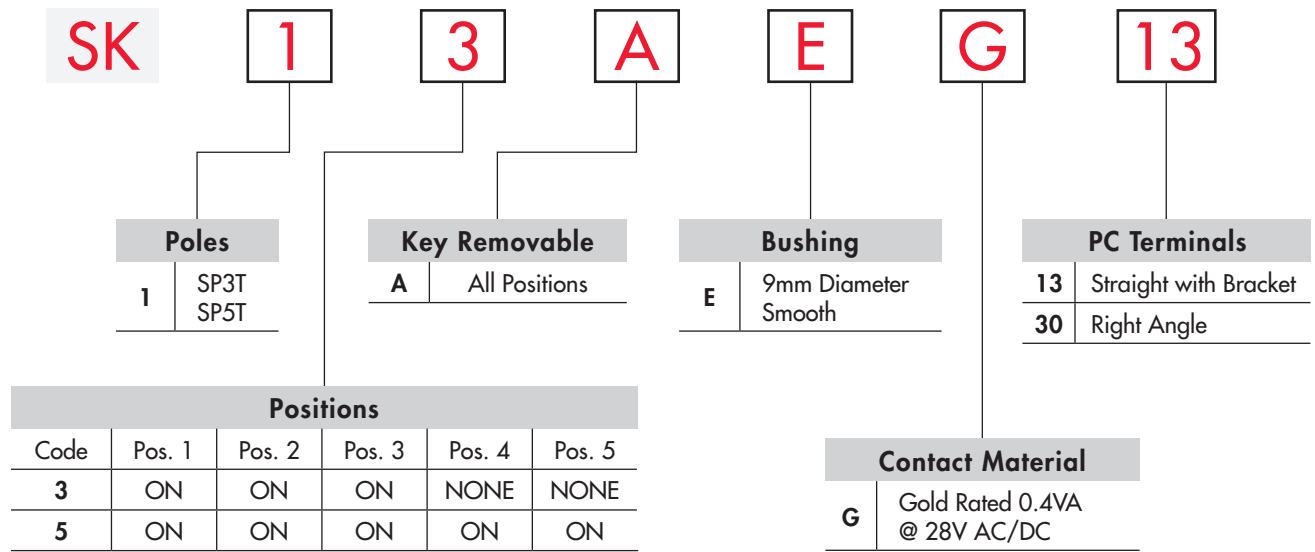

DESCRIPTION FOR TYPICAL ORDERING EXAMPLE

SK13AEG13

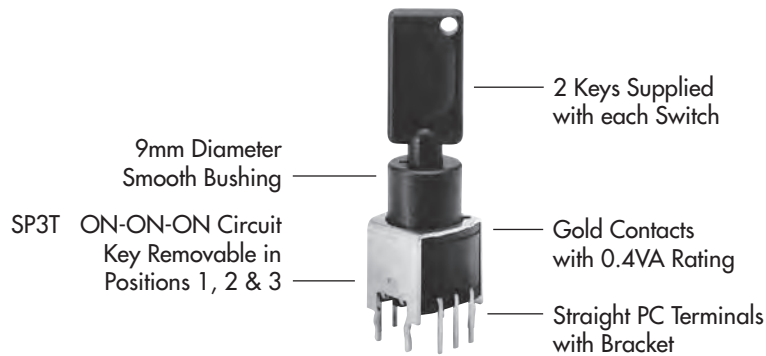

POLES, CIRCUITS & KEY-REMOVABLE POSITIONS

Pole & Throw	Model	Key Positions					Connected Terminals (Terminal numbers are not on switch)					Schematic	⊙ = Key Removable ● = Not Removable ✓ = Maximum Arc
		Pos 1	Pos 2	Pos 3	Pos 4	Pos 5	Pos 1	Pos 2	Pos 3	Pos 4	Pos 5		
SP3T	SK13A	ON	ON	ON	----	----	C1-2	C1-3	C1-4	----	----		
SP5T	SK15A	ON	ON	ON	ON	ON	C1-1	C1-2	C1-3	C1-4	C1-5		

KEY REMOVABLE

BUSHING

**A** All Positions  
45° Angular Throw

**E** 9mm Diameter Smooth

## CONTACT MATERIAL & RATING

**G**

Gold over Bronze or Copper

Logic Level

0.4VA @ 28V AC/DC maximum

## TERMINALS

**13**

Straight PC with Bracket

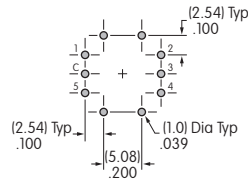
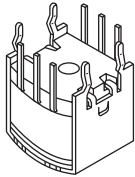

**30**

Right Angle PC

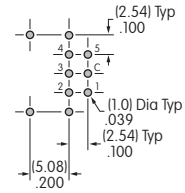
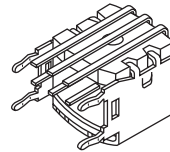

## KEY

**AT4094**  
Tubular Key

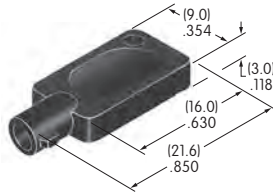

Material: Polyacetal

2 keys provided with each switch

## TYPICAL SWITCH DIMENSIONS

Straight PC with Bracket

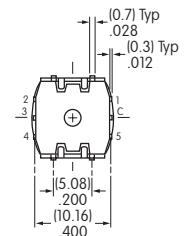
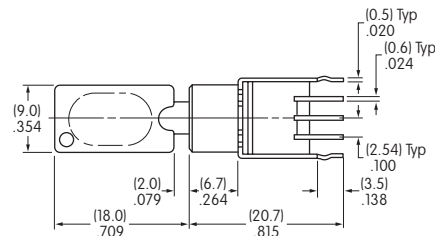
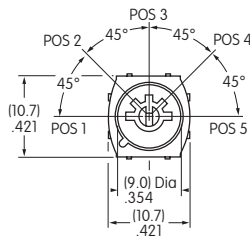
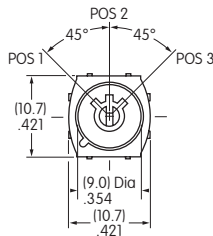

**SK13AEG13**

3 Position

5 Position

On 3-position models terminals 1 & 5 are support pins.

Right Angle PC

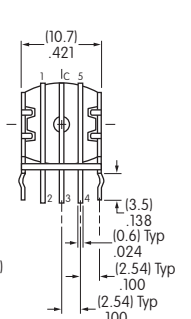
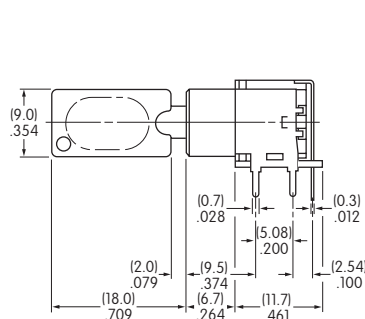
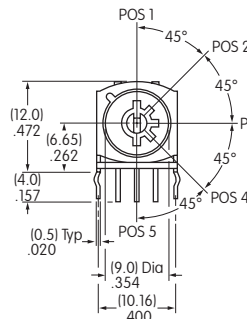
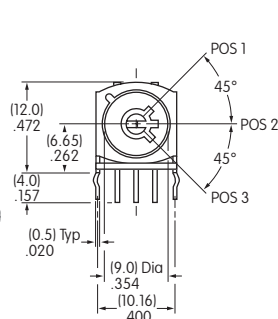

**SK15AEG30**

3 Position

5 Position

On 3-position models terminals 1 & 5 are support pins.



# General Specifications

## Electrical Capacity (Resistive Load)

**Logic Level:** 0.4VA maximum @ 28V AC/DC maximum  
(Applicable Range 0.1mA ~ 0.1A @ 20mV ~ 28V)  
See Supplement section to find explanation of operating range

## Other Ratings

**Contact Resistance:** 80 milliohms maximum  
**Insulation Resistance:** 100 megohms minimum @ 500V DC  
**Dielectric Strength:** 500V AC minimum for 1 minute minimum  
**Mechanical Life:** 30,000 cycles minimum  
**Electrical Life:** 10,000 cycles minimum  
**Nominal Operating Torque:** .026Nm (.234 lb•in) for momentary action models  
 .020Nm (.182 lb•in) for maintained action models  
**Contact Timing:** Break-before-make  
**Angle of Throw:** 90° for 2-position & 45° for 3-position

## Materials & Finishes

**Boot:** Polyvinyl chloride  
**Key:** Brass alloy with bright nickel plating;  
 brass alloy with bright nickel plating & ABS resin handle  
**Tumbler Barrel:** Polyacetal  
**Bushing:** Zinc alloy with nickel plating  
**Bracket:** Steel with tin plating  
**Base:** Glass fiber reinforced polyamide  
**Movable Contactor:** Beryllium copper with gold plating  
**Stationary Contacts:** Copper with gold plating  
**Terminals:** Brass with tin plating

## Environmental Data

**Operating Temperature Range:** -25°C through +70°C (-13°F through +158°F)  
**Humidity:** 90 ~ 95% humidity for 240 hours @ 40°C (104°F)  
**Vibration:** 10 ~ 55Hz with peak-to-peak amplitude of 1.5mm traversing the frequency range & returning  
 in 1 minute; 3 right angled directions for 2 hours  
**Shock:** 50G (490m/s<sup>2</sup>) acceleration (tested in 6 right angled directions, with 5 shocks in each direction)

## PCB Processing

**Soldering:** Wave Soldering recommended: See Profile B in Supplement section.  
 Manual Soldering: See Profile B in Supplement section.  
**Cleaning:** Automated cleaning. Boot must be on switch during processing.  
 See Cleaning specifications in Supplement section.

## Standards & Certifications

These SK Series devices have not been tested for UL recognition or CSA certification. These switches are designed for use in a low-voltage, low-current, logic-level circuit. When used as intended in a logic-level circuit, the results do not produce hazardous energy.

Toggles

Rockers

Pushbuttons

Programmable Illuminated PB

Keylocks **F**

Rotaries

Slides

Tactiles

Tilt

Touch

Indicators

Accessories

Supplement

# Distinctive Characteristics

Sealed body construction plus disposable boot protect contacts and allow automated processing.

Molded-in terminals seal out flux, solvents, and other contaminants.

Short body size for space-saving, behind panel dimensions.

Detent mechanism, with its spring-operated steel ball, gives crisp, positive action for accurate switch setting.

Bifurcated, self-wiping contact mechanism provides unequalled logic-level reliability and smoother, positive detent actuation.

Crimped bracket legs ensure secure PCB mounting and prevent dislodging during automated wave soldering.

.100" x .100" (2.54mm x 2.54mm) terminal spacing conforms to standard PC board grid spacing.

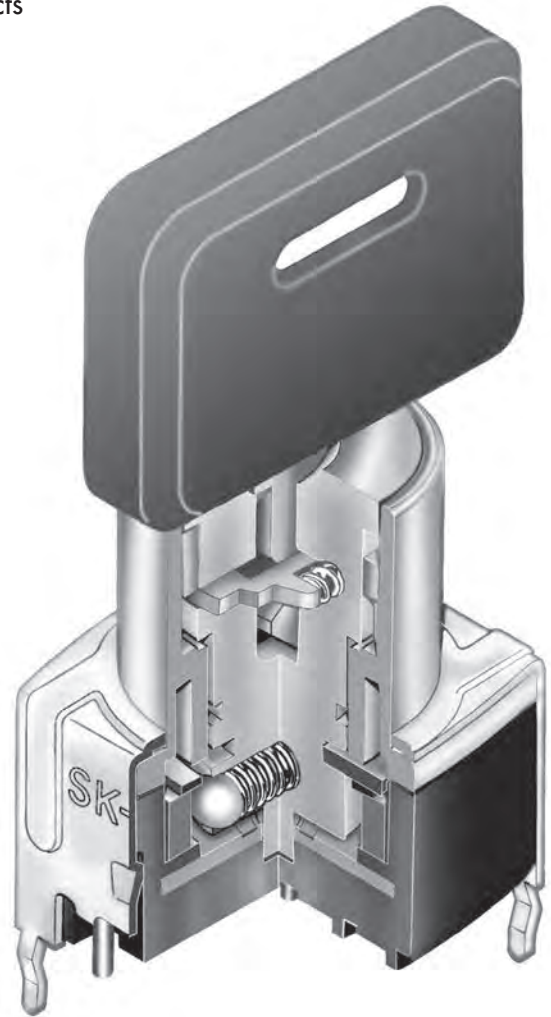

Actual Size

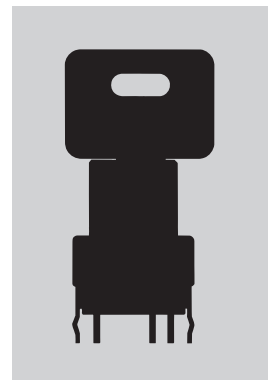

TYPICAL SWITCH ORDERING EXAMPLE

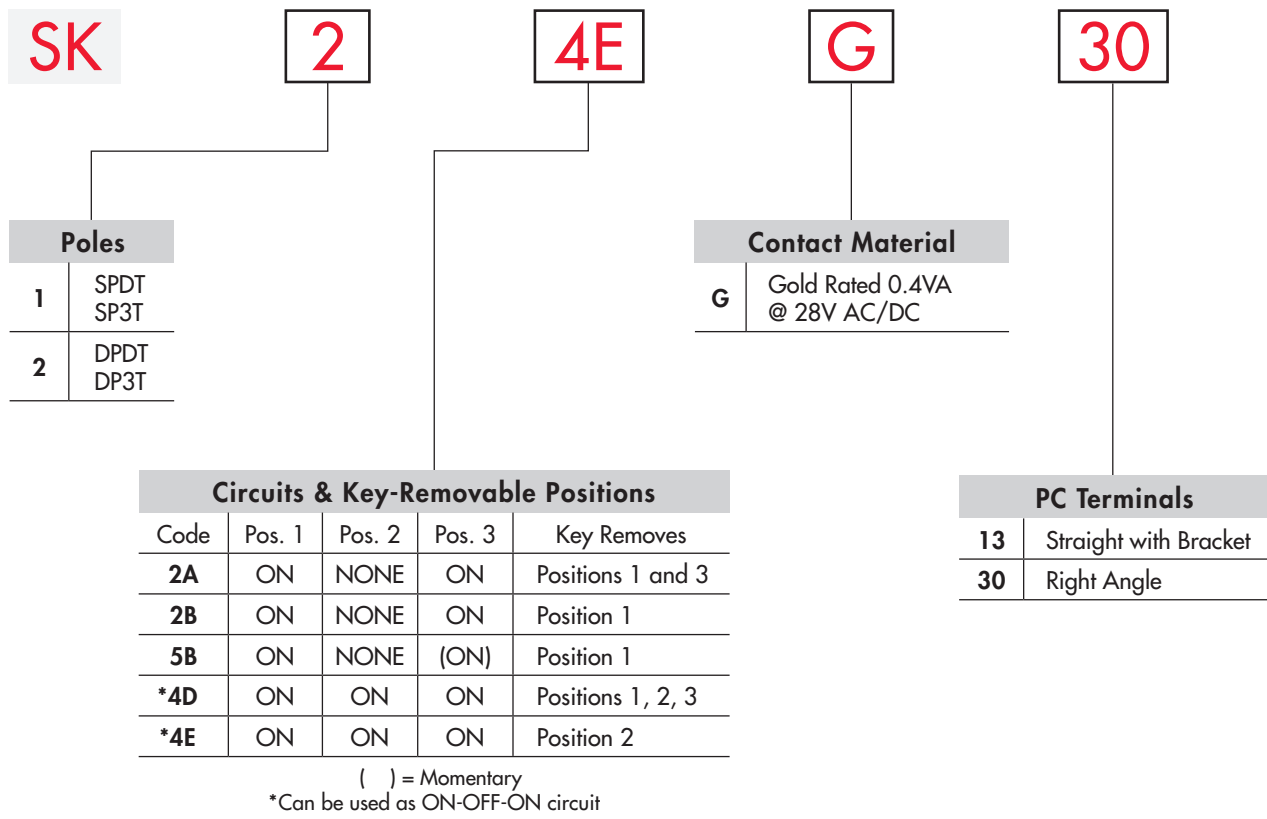

DESCRIPTION FOR TYPICAL ORDERING EXAMPLE

**SK24EG30**



### POLES, CIRCUITS & KEY-REMOVABLE POSITIONS

Pole & Throw	Model	Key Positions			Connected Terminals (Terminal numbers are not on switch)			Schematic	⊙ = Key Removable • = Not Removable ✓ = Maximum Arc
		Pos 1	Pos 2	Pos 3	Pos 1	Pos 2	Pos 3		
SPDT	SK12A	ON	NONE	ON	C1-1	—	C1-2		
SPDT SPDT	SK12B SK15B	ON ON	NONE NONE	ON (ON)	C1-1	—	C1-2		
DPDT	SK22A	ON	NONE	ON	C1-1 C2-4	—	C1-2 C2-5		
DPDT DPDT	SK22B SK25B	ON ON	NONE NONE	ON (ON)	C1-1 C2-4	—	C1-2 C2-5		
SP3T	SK14D	ON	ON	ON	C1-1	C1-2	C1-3		
SP3T	SK14E	ON	ON	ON	C1-1	C1-2	C1-3		
DP3T	SK24D	ON	ON	ON	C1-1 C2-4	C1-2 C2-5	C1-3 C2-6		
DP3T	SK24E	ON	ON	ON	C1-1 C2-4	C1-2 C2-5	C1-3 C2-6		

### KEY REMOVABLE

**A** Positions 1 & 3  
90° Angular Throw

**B** Position 1  
90° Angular Throw

**D** Positions 1, 2 & 3  
45° Angular Throw

**E** Position 2  
45° Angular Throw

### CONTACT MATERIAL & RATING

**G** Gold over Copper

Logic Level

0.4VA maximum @ 28V AC/DC maximum

### TERMINALS

**13** Straight PC Terminals with Bracket

**30** Right Angle PC Terminals

Double Throw Model

Three Throw Model

Double Throw Model

Three Throw Model

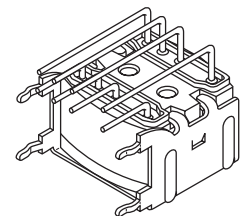
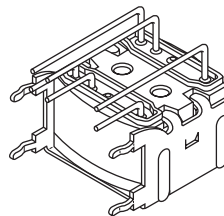
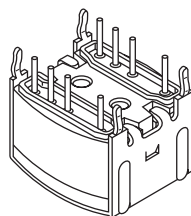
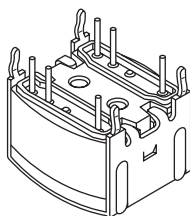

## KEYS

### AT4080 Standard Antistatic Plastic Handle

Brass Alloy with Bright Nickel Plating  
& ABS Resin Handle

2 keys supplied with each switch

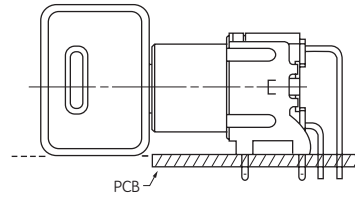
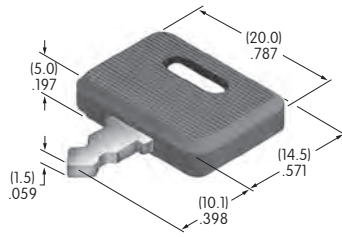

Suitable for all Straight PCB mount and for Right Angle PCB mount where clearance for key is obtainable.

### AT4079 for Right Angle Mid-board Mounting (Optional) All Metal

Brass Alloy with Bright Nickel Plating

Contact factory if metal keys needed

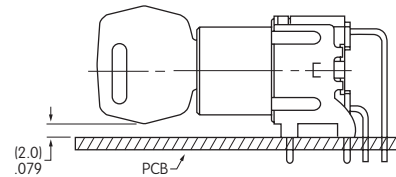
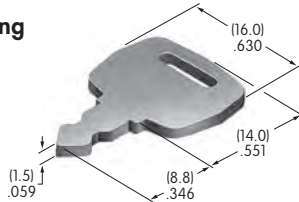

### Disposable Boot

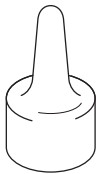

Each switch is supplied with a boot that provides protection from automated soldering and the cleaning process. Attach the boot without the key installed in the switch.

The boot is not reusable; discard after the washing procedure.

Polyvinyl Chloride



## TYPICAL SWITCH DIMENSIONS

### Single & Double Pole

### Straight PC with Bracket • Double Throw

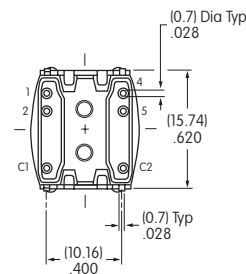
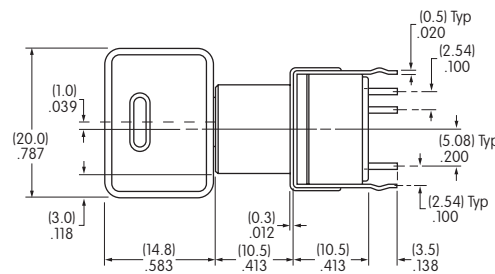
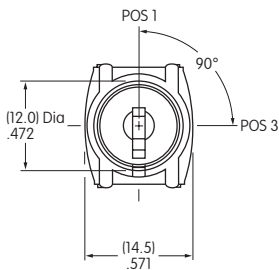

Single Pole models have only terminals 1, 2 & C1

**SK12AG13**

### Single & Double Pole

### Straight PC with Bracket • Three Throw

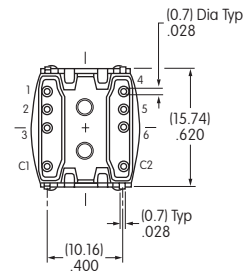
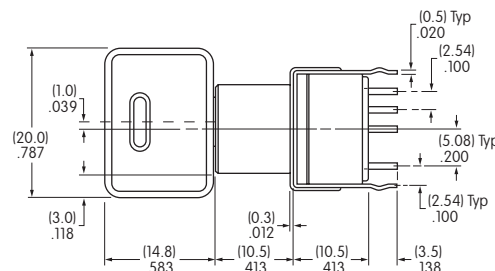
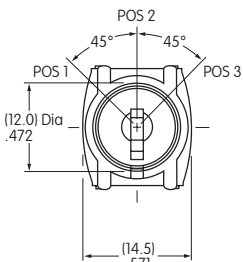

Single Pole models have only terminals 1, 2, 3 & C1

**SK24DG13**

## TYPICAL SWITCH DIMENSIONS

Right Angle  
PC Terminals  
Double Throw

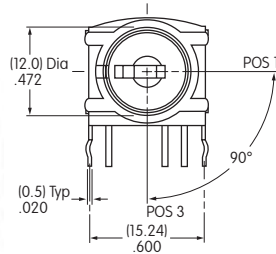

Key in Position 1

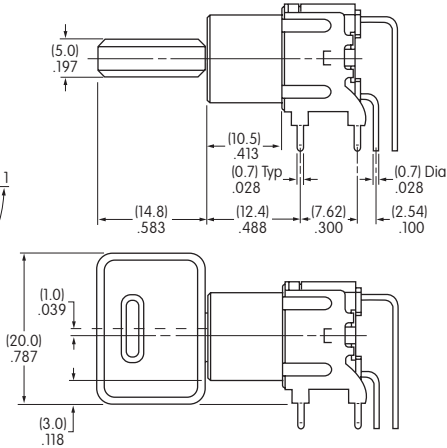

Single Pole

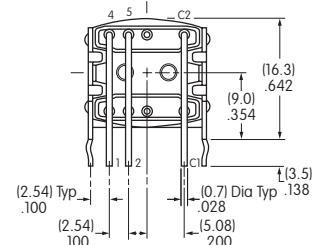
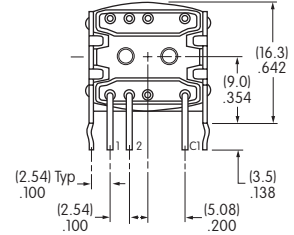

**SK15BG30**

Key in Position 3

Double Pole

Right Angle  
PC Terminals  
Three Throw

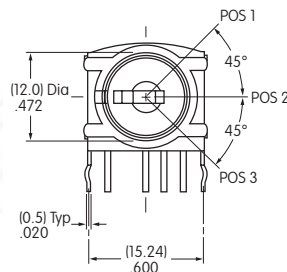

Key in Position 2

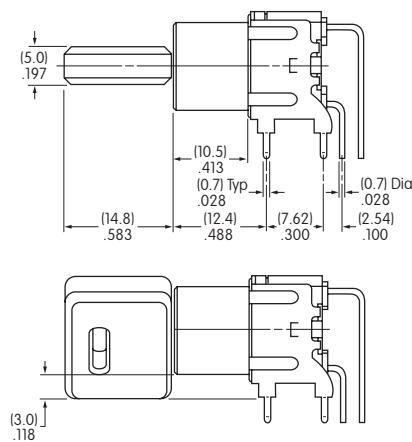

Single Pole

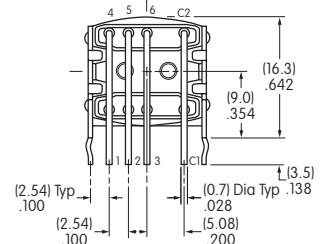
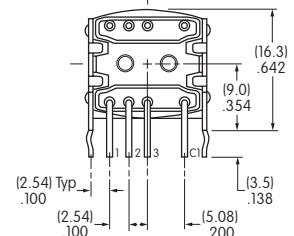

**SK24EG30**

Key in Position 1

Double Pole

Straight PC Footprints

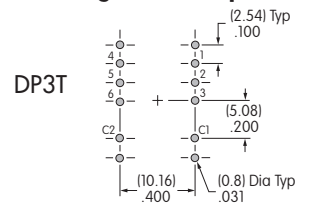
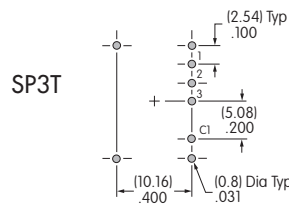
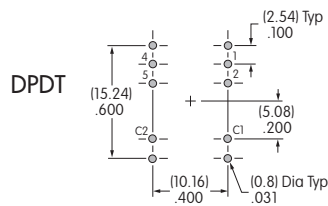
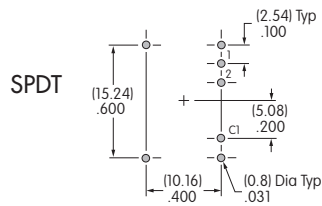

Right Angle PC Footprints

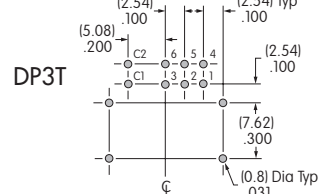
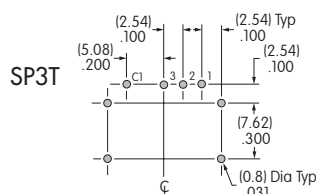
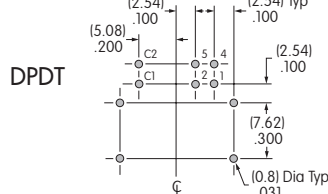
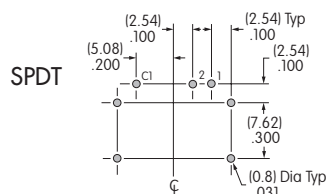

# General Specifications

Part Number: SK14DGMG01

## Electrical Capacity (Resistive Load)

Logic Level: 0.4VA maximum @ 28V AC/DC maximum  
(Applicable Range 0.1mA ~ 0.1A @ 20mV ~ 28V)

## Other Ratings

**Contact Resistance:** 100 milliohms maximum  
**Insulation Resistance:** 100 megohms minimum @ 500V DC  
**Dielectric Strength:** 500V AC minimum between contacts for 1 minute minimum  
**Mechanical Life:** 30,000 operations minimum  
**Electrical Life:** 10,000 operations minimum  
**Static Capability:** Withstands 15 kilovolts ESD  
**Nominal Operating Force:** 0.02Nm (0.18 lb•in)  
**Contact Timing:** Break-before-make  
**Angle of Throw:** 45°

## Materials & Finishes

**Key:** Brass alloy with bright nickel plating and ABS resin handle  
**Housing:** Polyamide  
**Base:** Glass fiber reinforced polyamide  
**Rotor:** Glass fiber reinforced polyamide  
**Tumbler Plate:** Brass  
**Movable Contacts:** Beryllium copper with gold plating  
**Stationary Contacts:** Brass with gold plating  
**Switch Terminals:** Brass with gold plating

## Environmental Data

**Operating Temperature Range:** -40°C through +85°C (-40°F through +185°F)  
**Humidity:** 90 ~ 95% humidity for 240 hours @ 60°C (140°F)  
**Vibration:** 10 ~ 55Hz with peak-to-peak amplitude of 1.5mm traversing the frequency range & returning in 1 minute; 3 right angled directions for 2 hours  
**Shock:** 50G (490m/s<sup>2</sup>) acceleration (tested in 6 right angled directions, with 5 shocks in each direction)

## PCB Processing

**Soldering:** Manual Soldering: lead-free, see profile below. Do not exceed these specifications.  
**Cleaning:** Hand clean locally using alcohol based solution.

Solder Iron Tip Temperature 370°C  
 Time on Terminal 4 seconds  
 Cycles 2

## Standards & Certifications

These devices have not been tested for UL recognition or CSA certification.  
 These devices are designed for use in a low-voltage, low-current, logic-level circuit.  
 When used as intended in a logic-level circuit, the results do not produce hazardous energy.



Actual Size

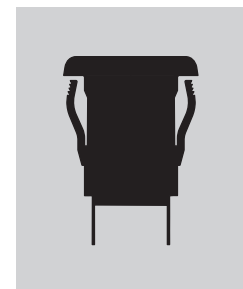

Toggle

Rockers

Pushbuttons

Illuminated PB

Programmable

**F** Keylocks

Rotaries

Slides

Tactiles

Tilt

Touch

Indicators

Accessories

Supplement

## POLES, CIRCUITS & KEY-REMOVABLE POSITIONS

Pole & Throw	Key Positions			Connected Terminals (Terminal numbers are on switch)			Schematic	⊙ = Key Removable ✓ = Maximum Arc
	Pos 1	Pos 2	Pos 3	Pos 1	Pos 2	Pos 3		
SP3T	ON	ON	ON	C-1	C-2	C-3		

## KEY

### AT4080 Standard Antistatic Plastic Handle

Material:  
Brass Alloy with Bright Nickel Plating  
& ABS Resin Handle

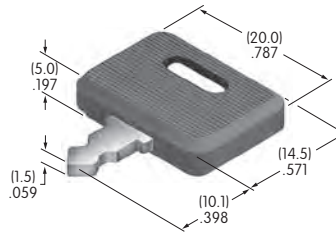

2 keys supplied with each switch

## TYPICAL SWITCH DIMENSIONS

### Antistatic Snap-in • Flat Key



SK14DGMG01

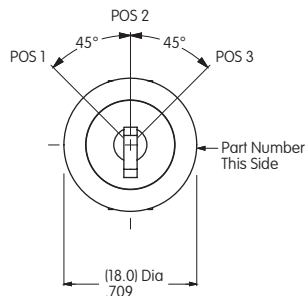

### Single Pole Three Throw

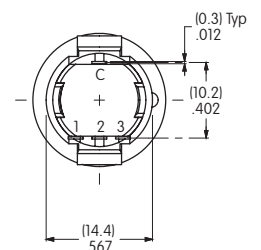
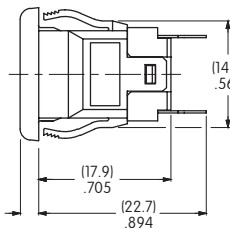
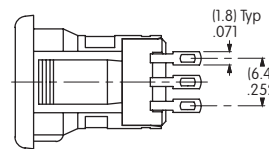

## PANEL CUTOUT

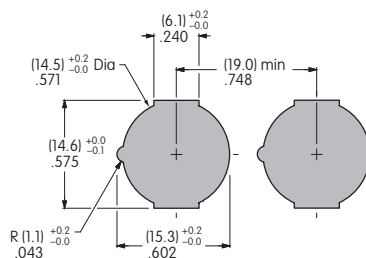

Panel Thickness Range  
.039" ~ .079"  
(1.0mm ~ 2.0mm)





Toggles

Rockers

Pushbuttons

Illuminated PB

Programmable

Keylocks

Rotaries **G**

Slides

Tactiles

Tilt

Touch

Indicators

Accessories

Supplement

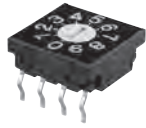

## FRO1 Series .....G4

10mm Ultra-Thin DIP; 100mA @ 5V DC; 100mA @ 50V DC  
 Straight PC & Right Angle PC  
 Through-hole Mount  
 Decimal & Hexadecimal



## FRO2 Series .....G12

10mm Ultra-Thin DIP; 100mA @ 5V DC; 100mA @ 50V DC  
 Gull Wing Terminals  
 Upright Mount  
 Decimal & Hexadecimal



## MR Series .....G16

0.4VA & 250mA Logic Level  
 Process Sealed  
 Straight PC  
 PC & Bushing Mount



## MR Series .....G22

Power Rated 2A, 3A, 5A & 10A @ 125V AC  
 PC Turret, Turret & Solder Lug  
 Bushing Mount



## MRB Series .....G28

0.4VA Logic Level  
 Process Sealed  
 Straight & Right Angle Bracketed PC



## ND Series .....G34

8mm Process Sealed DIP; 100mA @ 5V DC  
 Straight & Right Angle PC  
 Decimal & Hexadecimal



## ND3 Series .....G38

8mm Process Sealed DIP; 100mA @ 5V DC  
 Gull Wing Terminals  
 Upright & Right Angle Mount  
 Decimal & Hexadecimal



**HS13 & HS16 Series..... G46**

6A & 12A @ 125V AC  
**HS13:** 2-4 Positions; Nonshorting  
**HS16:** 1-6 Poles; 2-11 Positions; Nonshorting or Shorting  
 Solder Lug  
 Bushing Mount



**TS Series ..... G46**

6A @ 125V AC  
 1-5 Poles  
 2-11 Positions  
 Nonshorting  
 Screw Lug  
 Bushing Mount



**PS Series ..... G46**

30A @ 125V AC  
 1-5 Poles  
 2-11 Positions  
 Nonshorting  
 Screw Lug  
 Bushing Mount

Toggle

Rockers

Pushbuttons

Illuminated PB

Programmable

Keylocks

**G** Rotaries

Slides

Tactiles

Tilt

Touch

Indicators

Accessories

Supplement

# General Specifications

## Electrical Capacity (Resistive Load)

<b>Switching Rating:</b>	100mA @ 5V DC
<b>Nonswitching Rating:</b>	100mA @ 50V DC

## Other Ratings

<b>Contact Resistance:</b>	100 milliohms maximum; 30 milliohms maximum for contact point
<b>Insulation Resistance:</b>	1,000 megohms minimum @ 250V DC
<b>Dielectric Strength:</b>	250V AC minimum for 1 minute minimum
<b>Mechanical Life:</b>	10,000 detent operations minimum
<b>Electrical Life:</b>	10,000 detent operations minimum

Notes: A detent operation is one actuator position operation or stepping.  
A cycle is one 360° rotation. 10,000 detent operations equal 625 cycles for hexadecimal devices or 1,000 cycles for decimal devices.

<b>Nominal Operating Torque:</b>	Metal Shaft: 0.009Nm for decimal devices; 0.011Nm for hexadecimal devices All other Actuator types: 0.008Nm for decimal devices; 0.01Nm for hexadecimal devices
<b>Contact Timing:</b>	Nonshorting

## Materials & Finishes

<b>Actuators:</b>	Screwdriver and Plastic Shaft - Glass fiber reinforced polyamide (UL94V-0); Dial - Polyoxymethylene; Metal Shaft - Brass with nickel plating
<b>Bushing :</b>	Brass with nickel plating (for Metal Shaft model)
<b>Outer Case:</b>	Glass fiber reinforced PBT (for Metal Shaft model)
<b>Housing &amp; Base:</b>	Glass fiber reinforced polyamide (UL94V-0)
<b>Movable Contacts:</b>	Copper alloy with gold plating
<b>Stationary Contacts:</b>	Phosphor bronze with gold plating
<b>Terminals:</b>	Phosphor bronze with gold plating
<b>Terminal Cover:</b>	Polyamide (Right angle model only)
<b>Bracket:</b>	Phosphor bronze with tin plating (for Metal Shaft model)

## Environmental Data

<b>Operating Temperature Range:</b>	-25°C through +85°C (-13°F through +185°F)
<b>Humidity:</b>	90 ~ 95% humidity for 240 hours @ 40°C (104°F)
<b>Vibration:</b>	10 ~ 55Hz with peak-to-peak amplitude of 1.5mm traversing the frequency range & returning in 5 minutes; 3 right angled directions for 2 hours
<b>Shock:</b>	50G (490m/s <sup>2</sup> ) acceleration (tested in 6 right angled directions, with 5 shocks in each direction)

## Processing

<b>Soldering:</b>	Wave Soldering Recommended. See Profile A in Supplement section. Manual Soldering: See Profile A in Supplement section. Note: During soldering process, set the switch to the following position: FR01FR10P, FR01FR16P, FR01KR10P, FR01KR16P, FR01SR10P, FR01SR16P, FR01AR10PB, FR01AR16PB, FR01AR10HB, FR01AR16HB: 0 position; FR01FC10P, FR01KC10P, FR01FC10H, FR01KC10H, FR01SC10P, FR01AC10PB, FR01AC10HB: 7 position; FR01FC16P, FR01KC16P, FR01FC16H, FR01KC16H, FR01SC16P, FR01AC16PB, FR01AC16HB: F position
<b>Cleaning:</b>	These devices are not process sealed. Hand clean locally using alcohol based solution. Custom process sealed version available; contact factory.

## Standards & Certifications

<b>Flammability Standards:</b>	UL94V-0 rated actuator, housing and base The FR01 Series rotaries have not been tested for UL recognition or CSA certification. These switches are designed for use in a low-voltage, low-current circuit. When used as intended, the results do not produce hazardous energy.
--------------------------------	---

# Distinctive Characteristics

Compact dimensions and low profile allow high density mounting and close stacking of PC boards.

Highly visible legends and choice of screwdriver, shaft or dial actuators with arrow position indication provide trouble-free code setting. Knob actuator also available.

Real or complement code setting identified by color-keyed actuator.

Detent mechanism gives crisp, positive action for accurate switch setting.

Crimped terminals ensure secure PC mounting and prevent dislodging during soldering.

Cam activated movable contact and gold contacts assure contact reliability and continuity.

Surface mount model with screwdriver actuation available and shown in the surface mount section.

Contact factory for custom models with .200" (5.08mm) terminal spacing.

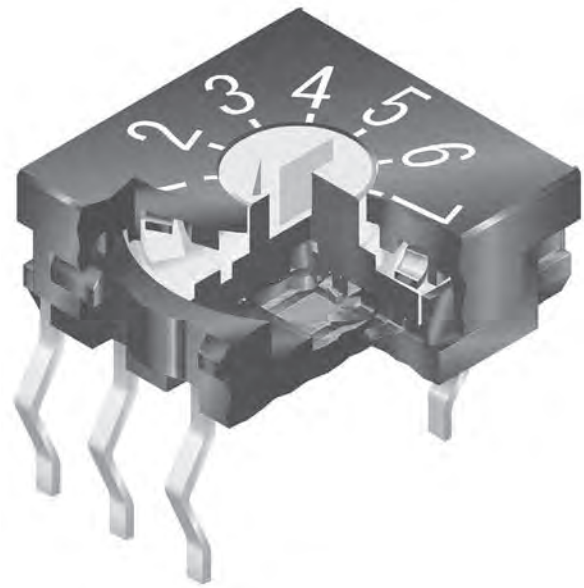

Actual Size

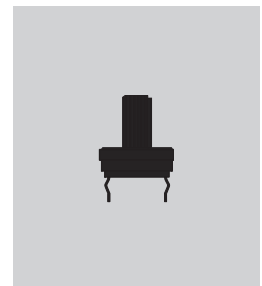

### TYPICAL SWITCH ORDERING EXAMPLE

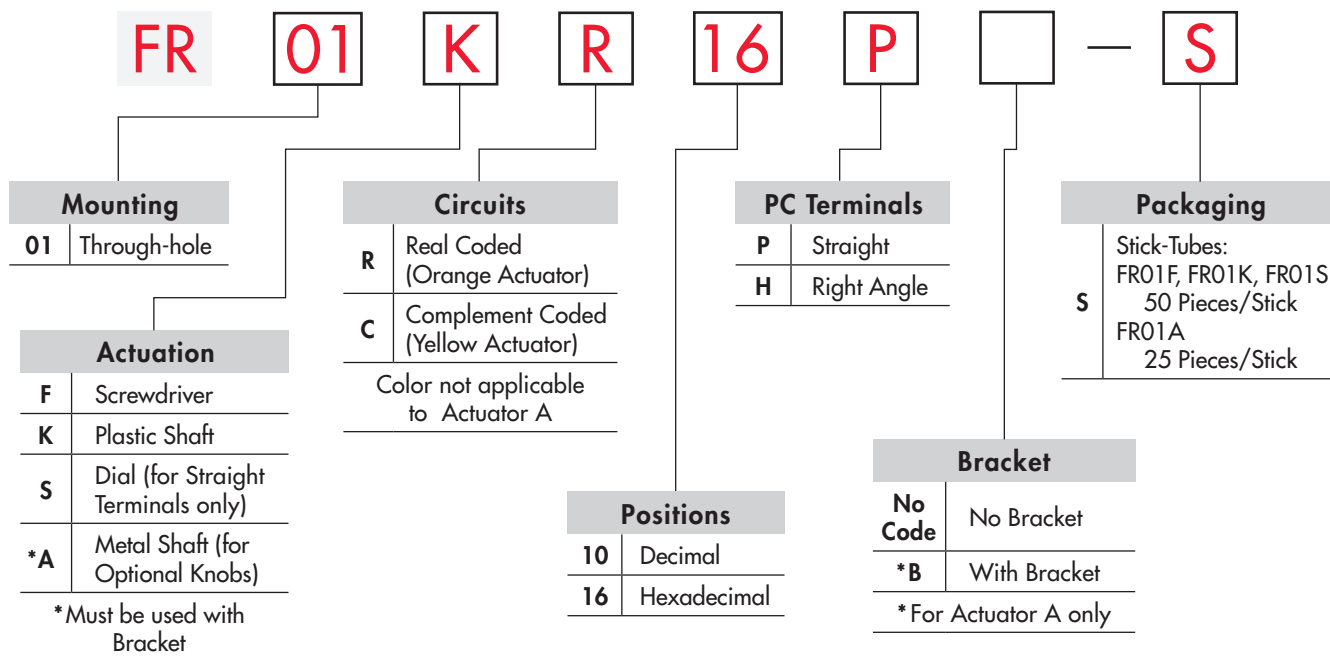

### DESCRIPTION FOR TYPICAL ORDERING EXAMPLE

**FR01KR16P-S**

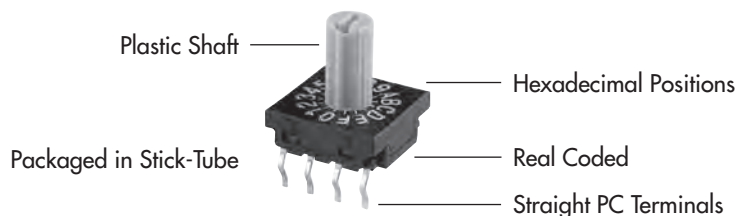

### MOUNTING

**01** Through-hole

### ACTUATION

**F** Screwdriver

Adjusted with a flat tipped screwdriver

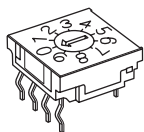

Actuators are fully rotational either clockwise or counterclockwise.  
Actuator Colors: Orange for real coded devices; Yellow for complement coded devices.

**AT4180**  
Optional Snap-on Knob

Polyamide  
Black knob with transparent flange

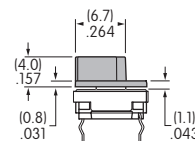
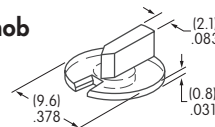

Install knob before mounting on PCB for right angle type; it should not be removed once mounted. When mounting, align slit in knob with arrowhead on actuator.

ACTUATION

**K** Plastic Shaft

Adjusted by hand or with flat tipped screwdriver

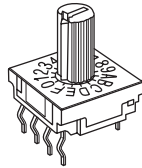

**S** Dial

Adjusted by hand or with flat tipped screwdriver

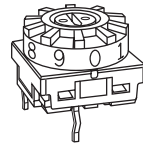

**A** Metal Shaft

Knob options illustrated below with color choices

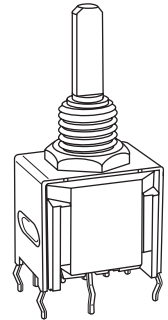

Actuators are fully rotational and operate either clockwise or counterclockwise. Colors for Actuators K and S: Orange for real coded devices; Yellow for complement coded devices

Mounting hardware is available if needed for models with Actuator A: Hexagon Nut AT513M, Locking Ring AT515M, and Lockwasher AT509; all are shown in the Accessories and Hardware section.

OPTIONAL KNOBS FOR METAL SHAFT

**AT433 Plain Black**

Material: Polyacetal

Color: Black

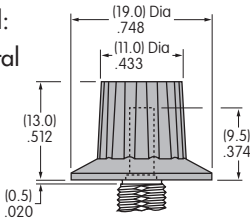

**AT4103 Small Color Tipped**

Polyester Base: Black

Polyamide Tip Colors:

A, B, C, E, F, G, H

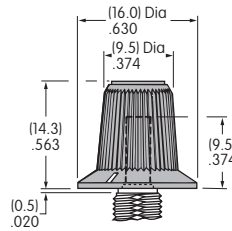

**AT4104 Large Color Tipped**

Polyester Base: Black

Polyamide Tip Colors:

A, B, C, E, F, G, H

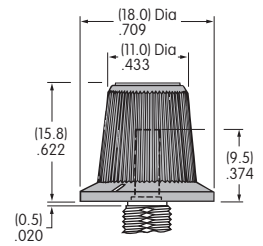

Knob Orientation: When installed with shaft flat rotated 180° from bushing flat as shown in "Typical Switch Dimensions," white line on cap points to Actuator Position 0 noted in truth tables below.

Color Codes: A Black B White C Red E Yellow F Green G Blue H Gray

TRUTH TABLES (CIRCUITS & POSITIONS)

Terminal No. (Output)	Actuator Position ● = ON	10 Decimal									16 Hexadecimal																	
		0	1	2	3	4	5	6	7	8	9	0	1	2	3	4	5	6	7	8	9	A	B	C	D	E	F	
<b>R</b> Real Coded Model Numbers: FR01FR, FR01KR, FR01SR, FR01AR	1		●				●		●		●																	
	2			●	●										●	●								●	●			
	4						●	●	●							●	●	●							●	●	●	
	8										●	●									●	●			●	●	●	●
<b>C</b> Complement Coded Model Numbers: FR01FC, FR01KC FR01SC, FR01AC	1	●				●					●															●		
	2	●	●				●	●				●	●												●	●		
	4	●	●	●	●							●	●	●											●	●	●	
	8	●	●	●	●	●	●	●													●	●			●	●	●	●

Terminal numbers are actually on the switch. Above sequence shown for clockwise rotation.

Toggle  
Rockers  
Pushbuttons  
Illuminated PB  
Programmable  
Key locks  
Rotaries  
Slides  
Tactiles  
Tilt  
Touch  
Indicators  
Accessories  
Supplement

## TYPICAL SWITCH DIMENSIONS

### P Straight PC • Screwdriver

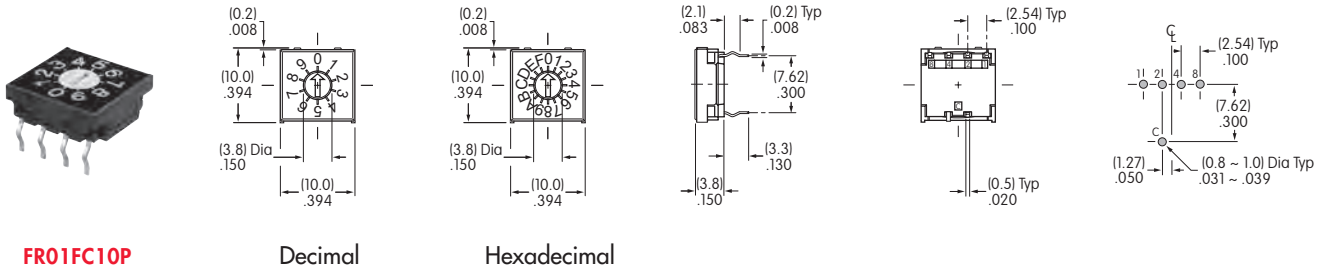

### H Right Angle PC • Screwdriver

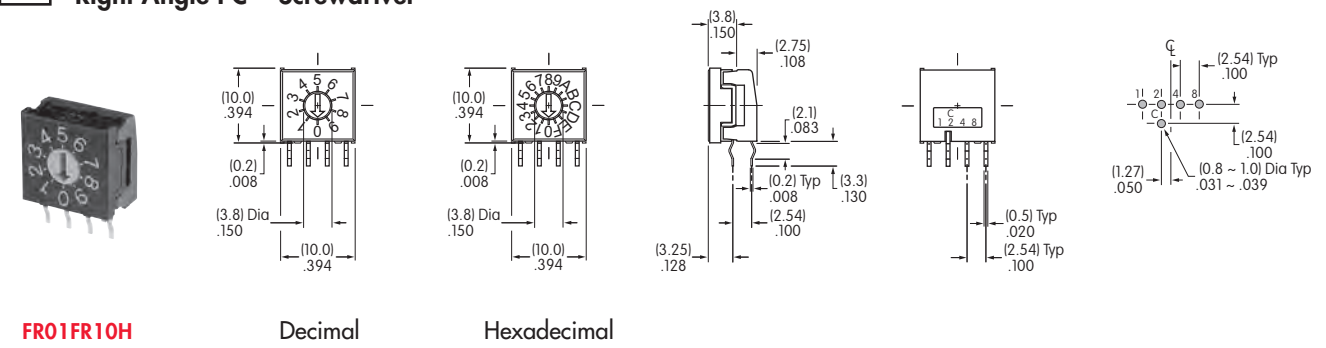

### P Straight PC • Plastic Shaft

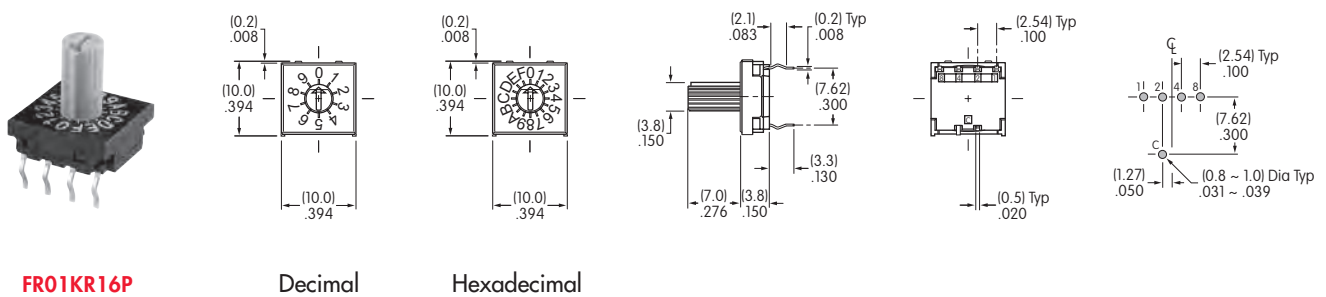

### H Right Angle PC • Plastic Shaft

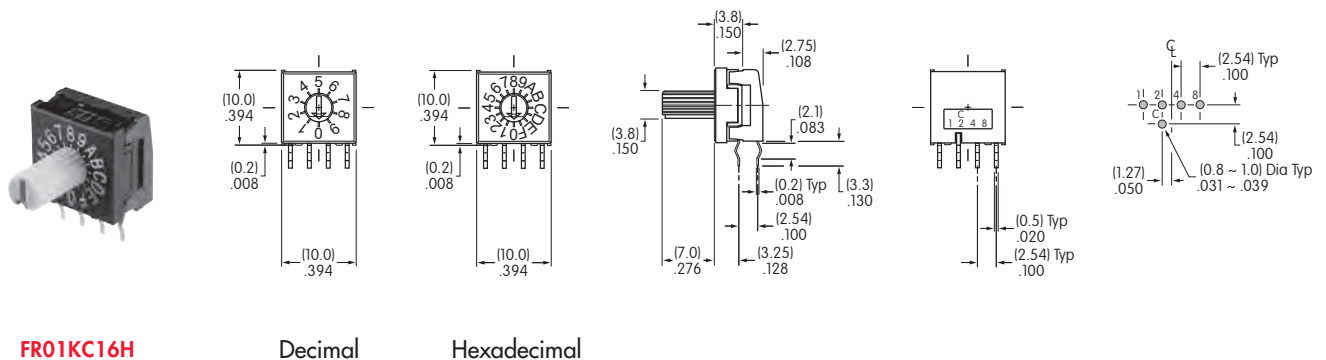



TYPICAL SWITCH DIMENSIONS

Straight PC • Dial

P

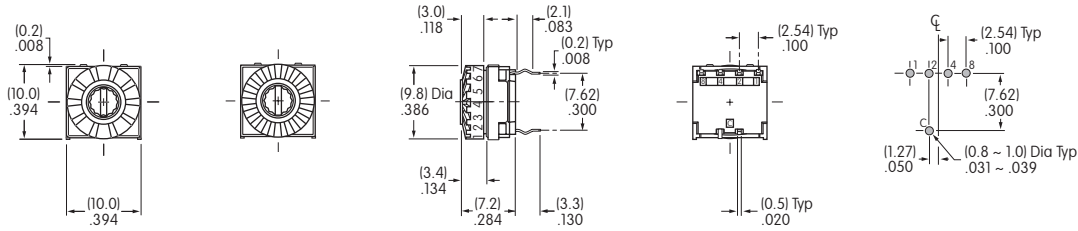

FR01SR10P

Decimal

Hexadecimal

Straight PC • Metal Shaft

P

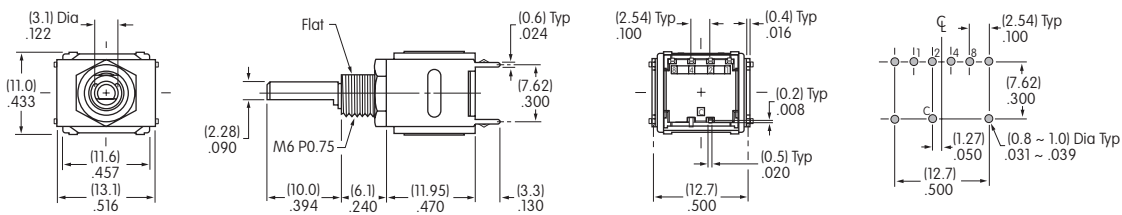

FR01AR10PB

Shown in Position 0 with shaft flat rotated 180° from bushing flat

Right Angle PC • Metal Shaft

H

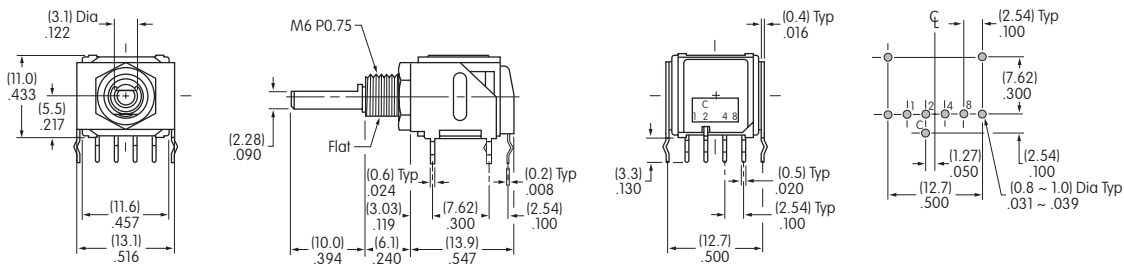

FR01AC16HB

Shown in Position 0 with shaft flat rotated 180° from bushing flat

### PACKAGING

**S**

#### Stick-Tube

##### FR01F, FR01K & FR01S

Each stick-tube contains 50 switches.  
Switches must be ordered in 50-piece increments.

##### FR01A

Each stick-tube contains 25 switches.  
Switches must be ordered in 25-piece increments.

Note: Transport and storage temperatures should not exceed 50°C (122°F). Store stick tubes on flat surface.



#### FR01F with Screwdriver Actuation & Straight PC

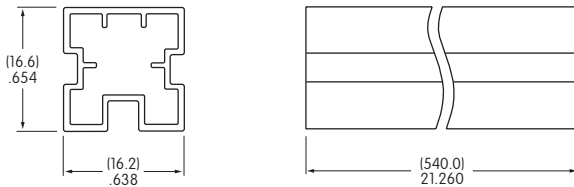

#### FR01K with Plastic Shaft & Right Angle PC

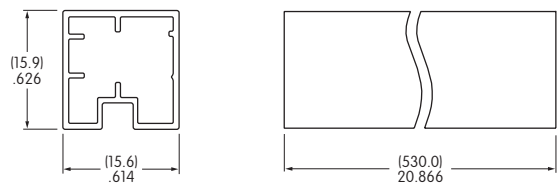

#### FR01S with Dial Actuation & Straight PC

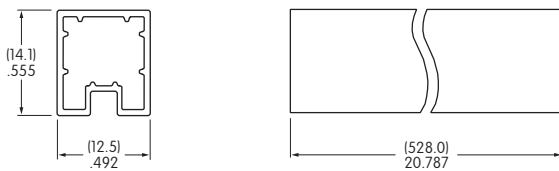

#### FR01A with Metal Shaft & Straight PC

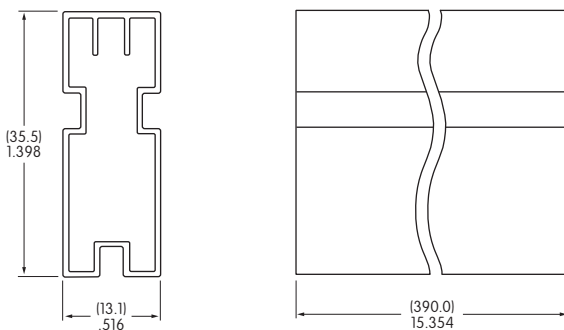

#### FR01A with Metal Shaft & Right Angle PC

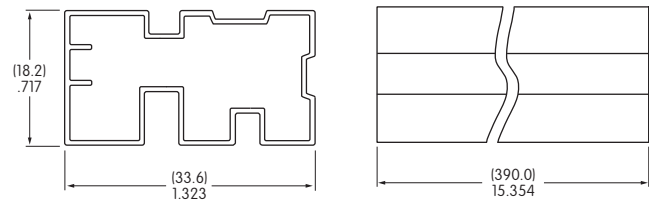



# General Specifications

## Electrical Capacity (Resistive Load)

<b>Switching Rating:</b>	100mA @ 5V DC
<b>Nonswitching Rating:</b>	100mA @ 50V DC

## Other Ratings

<b>Contact Resistance:</b>	100 milliohms maximum for circuit; 30 milliohms maximum for contact point
<b>Insulation Resistance:</b>	1,000 megohms minimum @ 250V DC
<b>Dielectric Strength:</b>	250V AC minimum for 1 minute minimum
<b>Mechanical Life:</b>	10,000 detent operations minimum
<b>Electrical Life:</b>	10,000 detent operations minimum

Notes: A detent operation is one actuator position operation or stepping.  
A cycle is one 360° rotation. 10,000 detent operations equal 625 cycles for hexadecimal devices or 1,000 cycles for decimal devices.

<b>Nominal Operating Torque:</b>	0.008Nm for decimal devices; 0.01Nm for hexadecimal devices
<b>Contact Timing:</b>	Nonshorting

## Materials & Finishes

<b>Actuator:</b>	Screwdriver and Plastic Shaft - Glass fiber reinforced polyamide (UL94V-0)
<b>Housing &amp; Base:</b>	Glass fiber reinforced polyamide (UL94V-0)
<b>Leaf Spring:</b>	Stainless steel
<b>Movable Contacts:</b>	Copper alloy with gold plating
<b>Stationary Contacts:</b>	Phosphor bronze with gold plating
<b>Terminals:</b>	Phosphor bronze with gold plating

## Environmental Data

<b>Operating Temperature Range:</b>	-25°C through +85°C (-13°F through +185°F)
<b>Humidity:</b>	90 ~ 95% humidity for 240 hours @ 40°C (104°F)
<b>Vibration:</b>	10 ~ 55Hz with peak-to-peak amplitude of 1.5mm traversing the frequency range & returning in 5 minutes; 3 right angled directions for 2 hours
<b>Shock:</b>	50G (490m/s <sup>2</sup> ) acceleration (tested in 6 right angled directions, with 5 shocks in each direction)

## Processing

<b>Soldering:</b>	Reflow Soldering Recommended. See Profile A in Supplement section. Manual Soldering: See Profile A in Supplement section. Note: During soldering process, set the switch to the following position: FR02FR10P, FR02FR16P, FR02KR10P, FR02KR16P: 0 position; FR02FC10P, FR02KC10P: 7 position; FR02FC16P, FR02KC16P: F position
<b>Cleaning:</b>	These devices are not process sealed. Hand clean locally using alcohol based solution.

## Standards & Certifications

<b>Flammability Standards:</b>	UL94V-0 rated actuator, housing, & base The FR02 Series rotaries have not been tested for UL recognition or CSA certification. These switches are designed for use in a low-voltage, low-current circuit. When used as intended, the results do not produce hazardous energy.
--------------------------------	--

# Distinctive Characteristics

Slim .150" (3.8mm) body has the lowest profile in the industry and allows close stacking of PC boards.

Highly visible legends and choice of screwdriver or shaft actuators with arrow position indication provide trouble-free code setting.

Detent mechanism gives crisp, positive action for accurate switch setting.

Use of heat resistant resin allows infrared convection reflow soldering.

Gull-winged terminals ensure mechanical stability during soldering and simplify solder joint inspection.

Cam activated movable contact and gold contacts assure contact reliability and continuity.

Tape-reel packaging meets EIA-481-2 Standard.

Coplanarity: all considered surfaces must lie between two parallel planes that are a maximum distance apart of .0059" (0.15mm). (Additional coplanarity details in Terms and Acronyms in the Supplement section.)

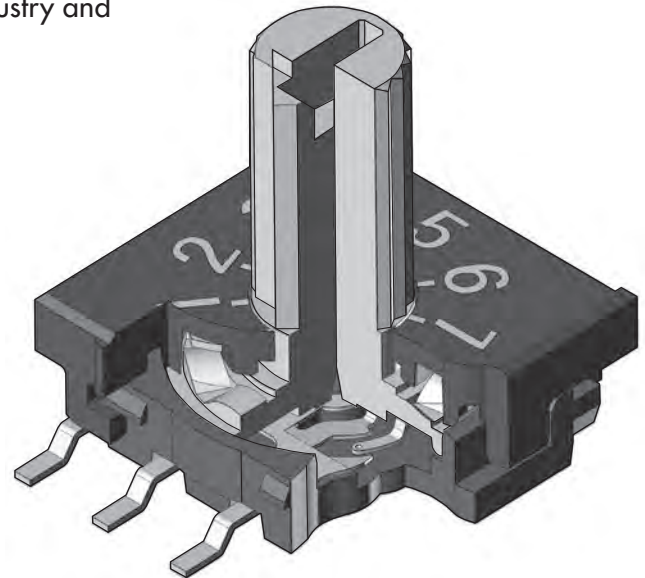

Actual Size

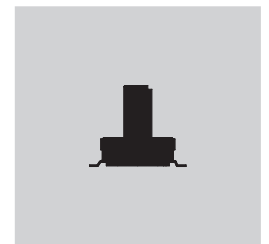

## TRUTH TABLES (CIRCUITS & POSITIONS)

Actuator Position ● = ON		10 Decimal										16 Hexadecimal																	
		0	1	2	3	4	5	6	7	8	9	0	1	2	3	4	5	6	7	8	9	A	B	C	D	E	F		
Terminal No. (Output)																													
<b>R</b> Real Coded Model Numbers: FR02FR, FR02KR	1		●		●		●		●		●		●		●		●		●		●		●		●		●		●
	2			●	●			●	●			●	●			●	●			●	●			●	●			●	●
	4					●	●	●	●																				
	8						●	●	●	●																			
<b>C</b> Complement Coded Model Numbers: FR02FC, FR02KC	1	●		●		●		●		●		●		●		●		●		●		●		●		●		●	
	2	●	●			●	●			●	●			●	●			●	●			●	●			●	●		
	4	●	●	●	●					●	●	●	●					●	●	●	●					●	●	●	
	8	●	●	●	●	●	●	●	●					●	●	●	●	●	●	●									

Terminal numbers are actually on the switch.

### TYPICAL SWITCH ORDERING EXAMPLE

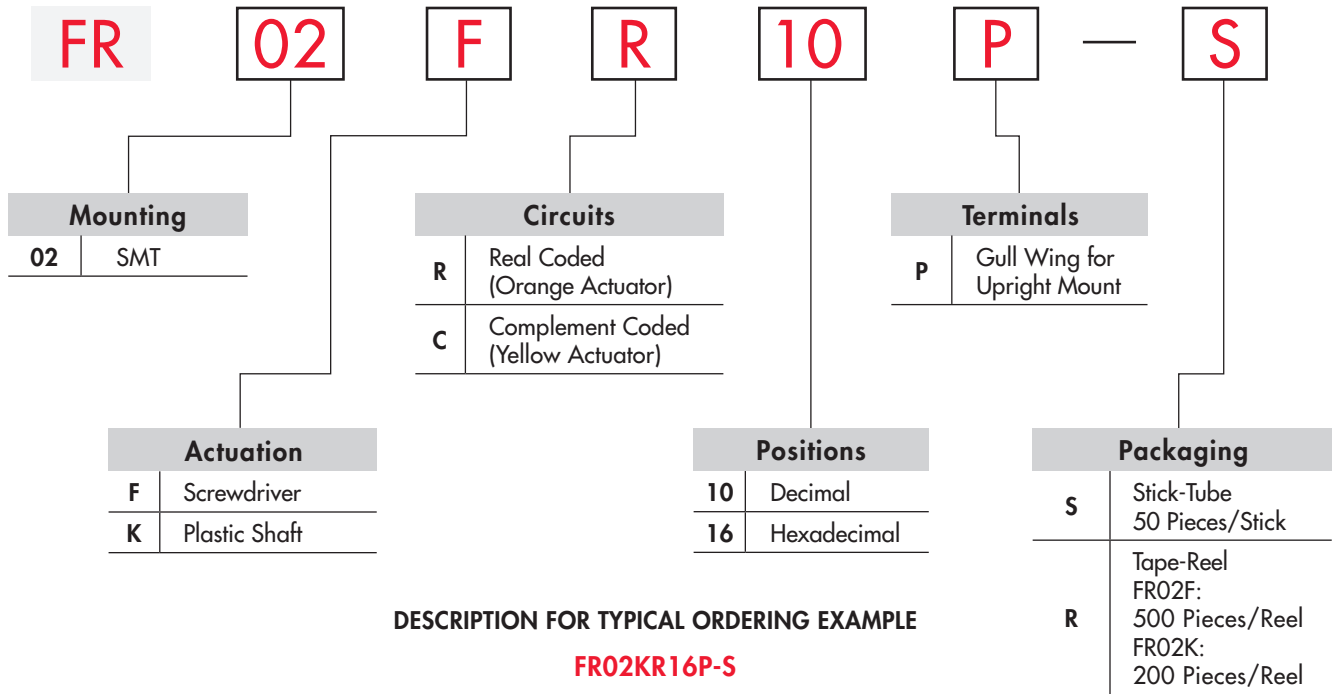

### DESCRIPTION FOR TYPICAL ORDERING EXAMPLE

**FR02KR16P-S**

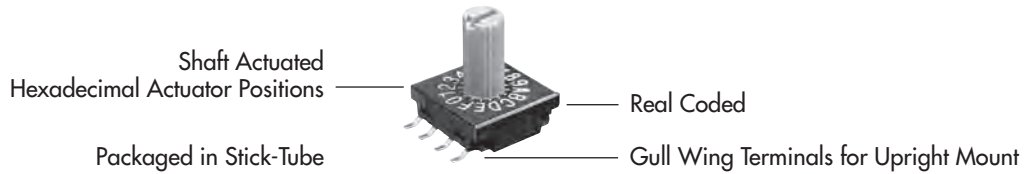

### ACTUATION

**F** Screwdriver  
Adjusted with a flat tipped screwdriver

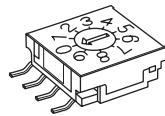

**K** Plastic Shaft  
Adjusted by hand or with flat tipped screwdriver

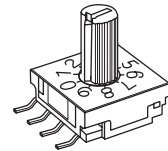

Actuators are fully rotational either clockwise or counterclockwise.  
Actuator Colors: Orange for real coded devices; Yellow for complement coded devices.

### TYPICAL SWITCH DIMENSIONS

**P** Upright • Screwdriver



**FR02FC10P**

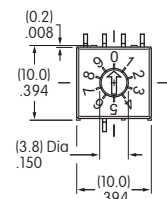

Decimal

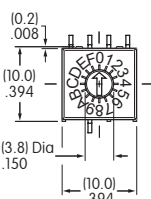

Hexadecimal

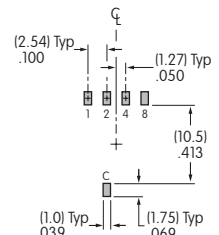
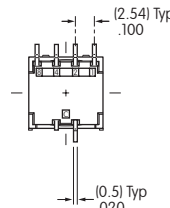
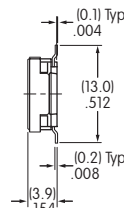

## TYPICAL SWITCH DIMENSIONS

Upright • Plastic Shaft

**P**

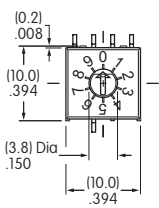

Decimal

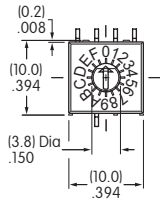

Hexadecimal

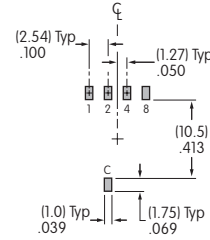
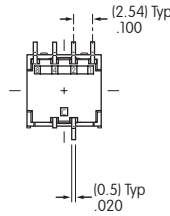
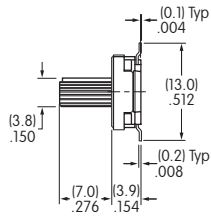

FR02KC16P

## PACKAGING

**S** Stick-Tube

FR02F & FR02K

Each stick-tube contains 50 switches.  
Switches must be ordered in 50-piece increments.

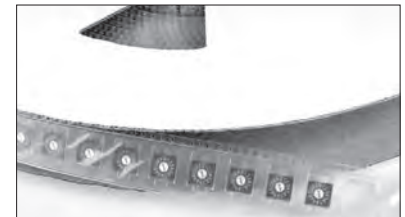
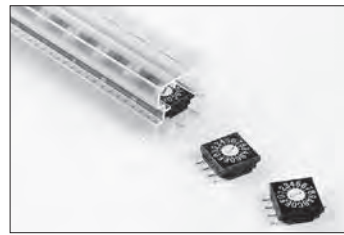
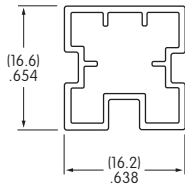

**R** Tape-Reel

FR02F

Switches must be ordered in 500-piece increments.  
This packaging meets EIA-481-2 Standard.

Each tape-reel of 550 pockets contains 500 switches.  
Minimum Leader Length: 15.748" (400mm)  
Minimum Trailer Length: 6.299" (160mm)

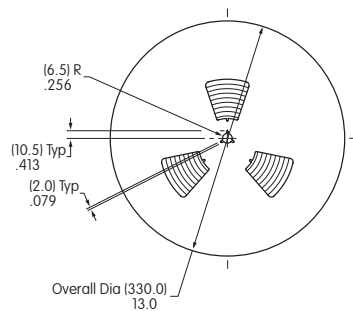

FR02F

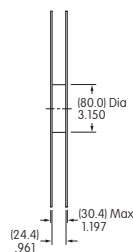

FR02K

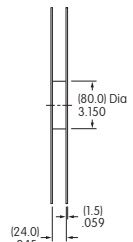

FR02K

Switches must be ordered in 200-piece increments.  
This packaging meets EIA-481-2 Standard.

Each tape-reel of 250 pockets contains 200 switches.  
Minimum Leader Length: 15.748" (400mm)  
Minimum Trailer Length: 6.299" (160mm)

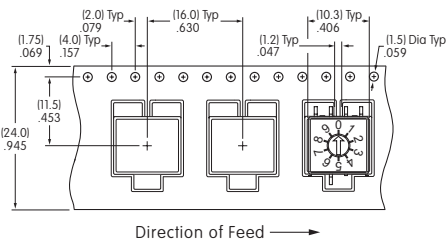

Direction of Feed →

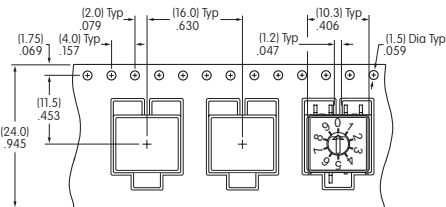

Direction of Feed →

# General Specifications

## Electrical Capacity (Resistive Load)

- For MRA:** 250mA @ 125V AC  
**For MRF or MRK:** 0.4VA maximum @ 28V AC/DC maximum  
 (Applicable Range 0.1mA ~ 0.1A @ 20mV ~ 28V)  
 Note: Find additional explanation of operating range in Supplement section.

## Other Ratings

- Contact Resistance:** 10 milliohms maximum for MRA; 50 milliohms maximum for MRF & MRK  
**Insulation Resistance:** 100 megohms minimum @ 500V DC  
**Dielectric Strength:** 1,000V AC minimum for 1 minute minimum for MRA  
 500V AC minimum for 1 minute minimum for MRF & MRK  
**Mechanical Life:** 30,000 operations minimum  
**Electrical Life:** 10,000 operations minimum  
**Range of Operating Torque:** 0.02 ~ 0.07Nm for MRA; 0.005 ~ 0.02Nm for MRF & MRK  
**Contact Timing:** Nonshorting (break-before-make)  
 MRA – self-cleaning, sliding contact; MRF & MRK – self-cleaning, rotary contactor disk  
**Indexing:** 30°

## Materials & Finishes

- Shaft:** Brass with nickel plating  
**Stopper Plate:** Steel with zinc plating for MRA & MRK; polyamide cover with stopper for MRF  
**Bushing/Housing:** Zinc alloy with zinc plating  
**Movable Contacts:** Copper with silver plating for MRA; phosphor bronze with gold plating for MRF & MRK  
**End Contacts & Terminals:** Brass with silver plating for MRA; phosphor bronze with gold plating for MRF & MRK  
**Common Contacts & Terminals:** Brass with silver plating for MRA; phosphor bronze with gold plating for MRF & MRK  
**Base:** Diallyl phthalate for MRA; fiberglass reinforced polyamide for MRF & MRK

## Environmental Data

- Operating Temperature Range:** -10°C through +70°C (+14°F through +158°F)  
**Humidity:** 90 ~ 95% humidity for 96 hours @ 40°C (104°F)  
**Vibration:** 10 ~ 55Hz with peak-to-peak amplitude of 1.5mm traversing the frequency range & returning in 1 minute; 3 right angled directions for 2 hours  
**Shock:** 50G (490m/s<sup>2</sup>) acceleration (tested in 3 right angled directions, with 3 shocks in each direction)  
**Sealing:** MRK model meets IP67 of IEC60529 standards

## Installation

- Mounting Torque:** .686Nm (6.08 lb•in)  
**Cap Installation Force:** 19.6 ~ 29.4N (4.41 ~ 6.61 lbf) for MRA & MRK

## Processing

- Soldering Time & Temperature:** Wave Soldering for MRA: See Profile A in Supplement section.  
 Wave Soldering for MRF & MRK: See Profile B in Supplement section.  
 Manual Soldering for MRA: See Profile A in Supplement section.  
 Manual Soldering for MRF & MRK: See Profile B in Supplement section.  
**Cleaning:** Automated cleaning recommended. Stopper plate, as well as washers for MRA & MRK, must be in place to maintain automated cleaning. See Cleaning specifications in Supplement section.

## Standards & Certifications

MRA, MRF, & MRK models have not been tested for UL recognition or CSA certification. These switches are designed for use in a low-voltage, low-current, logic-level circuit. When used as intended in a logic-level circuit, the results do not produce hazardous energy.



# Distinctive Characteristics

Low profile body of MRF model accommodates space limitations required for PCB mounting. For the MRA and MRK bushing mount models, the range of behind panel body depths is .323" to .669" (8.2mm to 17.0mm).

Positive detent mechanism for distinct feel and audible feedback.

Metal bushing and housing construction increases durability.

Adjustable stopper plate allows 2–12 position settings.

High contact reliability achieved by the self-cleaning contact mechanism.

Break-before-make contact timing with sliding contacts in MRA and rotary contactor disk in MRF and MRK models.

Interior housing seal and molded-in PC terminals, plus shaft rubber o-ring on MRA and MRK and polyamide cover on MRF model, allow cleaning after automated soldering.

MRK model meets IP67 of IEC60529 specifications (similar to NEMA 4 & 13).

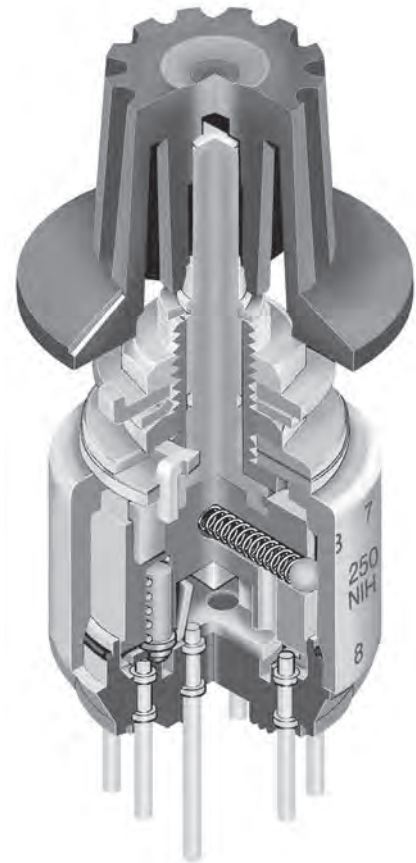

Actual Size

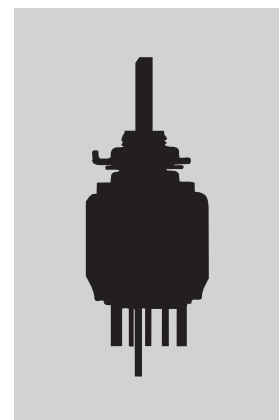

Toggle

Rockers

Pushbuttons

Illuminated PB

Programmable

Key locks

**G** Rotaries

Slides

Tactiles

Tilt

Touch

Indicators

Accessories

Supplement

### TYPICAL SWITCH ORDERING EXAMPLE

**MR**

**A**

**206**

**A**



#### Actuators & Terminals

<b>A</b>	Shaft Actuated with PC Terminals
<b>F</b>	Low Profile Screwdriver Actuated with PC Terminals
<b>K</b>	Low Profile Shaft Actuated with PC Terminals

#### Poles & Circuits

<b>112</b>	SP with 2-12 Positions
<b>206</b>	DP with 2-6 Positions
<b>403</b>	4P with 2-3 Positions

#### Knobs

<b>A</b>	Plain Black
<b>B</b>	Small Color Tipped
<b>C</b>	Large Color Tipped

#### Colors

For Plain Knob	
<b>No Code</b>	Black
For Color Tipped	
<b>A</b>	Black
<b>B</b>	White
<b>C</b>	Red
<b>E</b>	Yellow
<b>F</b>	Green
<b>G</b>	Blue
<b>H</b>	Gray

### DESCRIPTION FOR TYPICAL ORDERING EXAMPLE

**MRA206-A**

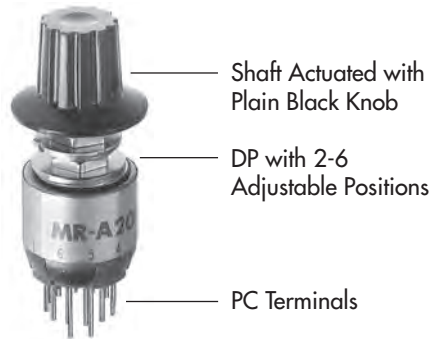

### ACTUATORS & TERMINALS

**A** Shaft Actuated with PC Terminals

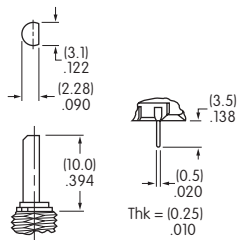
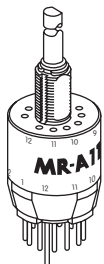

Shaft Terminal

**F** Low Profile Screwdriver Actuated with PC Terminals

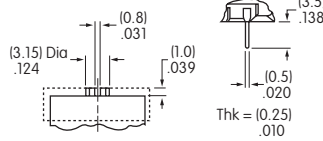

Slotted for Screwdriver Terminal

**K** Low Profile Shaft Actuated with PC Terminals

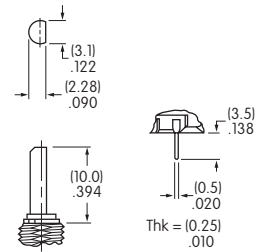
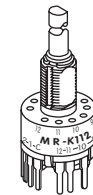

Shaft Terminal

POLES & CIRCUITS					
Pole	Model	Number of Positions	Stopper Settings	Number of Terminals	Schematics
SP	MRA112	2-12	2, 3, 4, . . . 12	1 COM, 12 LOAD	
	MRF112	2-12	2, 3, 4, . . . 12	1 COM, 12 LOAD	
	MRK112	2-12	2, 3, 4, . . . 12	1 COM, 12 LOAD	
DP	MRA206	2-6	2, 3, 4, 5, 6	2 COM, 12 LOAD	
	MRF206	2-6	2, 3, 4, 5, 6	2 COM, 12 LOAD	
	MRK206	2-6	2, 3, 4, 5, 6	2 COM, 12 LOAD	
4P	MRA403	2-3	2, 3	4 COM, 12 LOAD	
	MRF403	2-3	2, 3	4 COM, 12 LOAD	
	MRK403	2-3	2, 3	4 COM, 12 LOAD	

## POSITION SETTING FOR MRA, MRF, & MRK MODELS

Each switch is supplied with the stopper set for the maximum number of positions allowed for that model. Prior to installation, the desired position setting should be made. Contact factory for continuous rotation.

### MRF Models

1. Remove the protective cover from the switch body.
2. Turn the shaft counterclockwise to the extreme left by using a screwdriver.
3. Inside the cover is a magnifying lens which would be positioned over the number which is to be the maximum position used; when the cover is then snapped into the switch, the projection beside the lens fits into the correct hole for setting the stop.

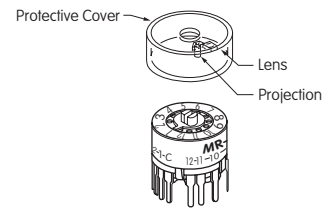

### MRK & MRA Models

1. Using the actuator knob, turn the shaft counterclockwise to the extreme left. If the shaft is not turned counterclockwise to the extreme left, proper setting cannot be achieved. At this extreme position, the white line on the knob points to the number 1 position shown on the side of the switch.
2. Remove the knob from the shaft and loosen the nut far enough to allow raising the stopper plate, plus washer(s), for resetting to the desired position.
3. Note the position numbers on the side of the switch; these correspond to the terminal numbers and stopper holes. Insert the stopper in the hole numbered for the maximum desired number of stop settings. Satisfactory switch functioning cannot be assured if the stopper plate is not properly positioned.
4. Tighten the nut (beveled side up) firmly against the stopper plate.

### Standard Mounting Hardware Packaged Loose with Each Switch:

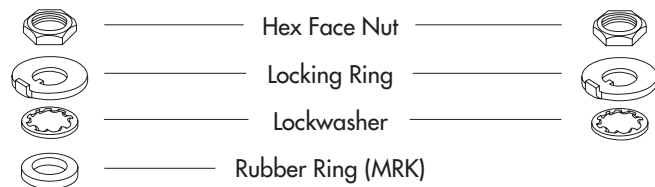

### Factory Assembled:

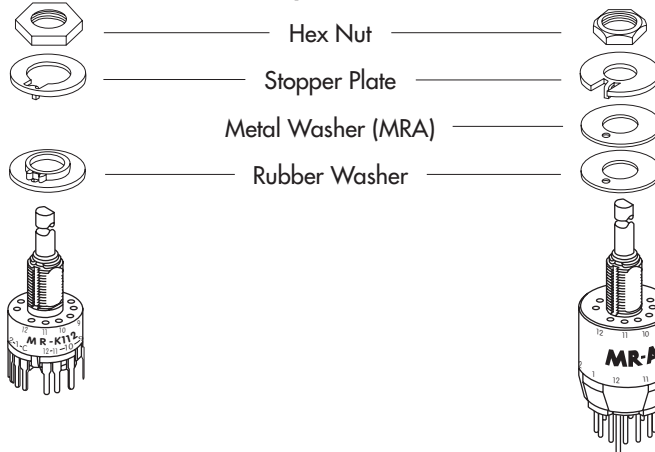

## TYPICAL SWITCH DIMENSIONS

### MRA • PC Terminals

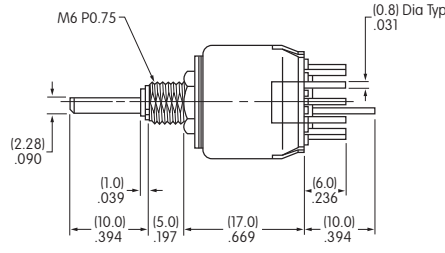
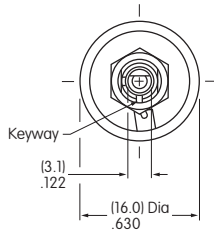

### 1 Pole

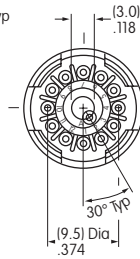

### 2 Pole

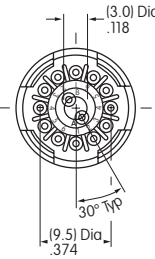

### 4 Pole

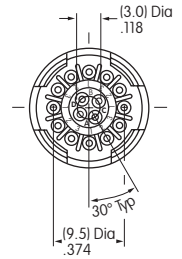

**MRA112**

### MRF • PC Terminals

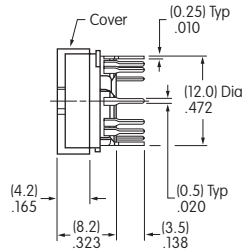
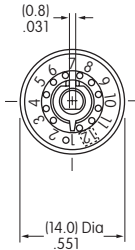

### 1 Pole

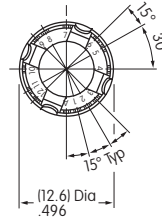

### 2 Pole

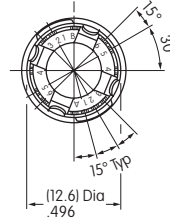

### 4 Pole

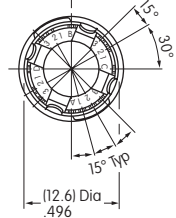

**MRF403**

### MRK • PC Terminals

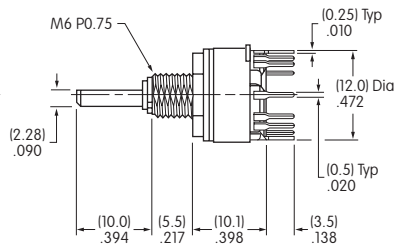
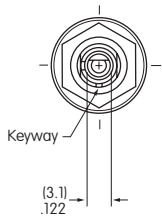

### 1 Pole

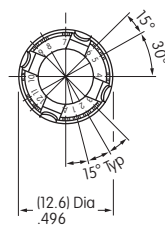

### 2 Pole

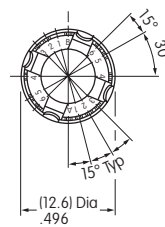

### 4 Pole

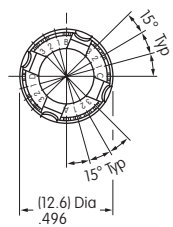

**MRK112**

MRK devices are designed to be panel mounted. Installation without panel mounting will affect reliability.

## FOOTPRINTS

Single Pole  
MRA112

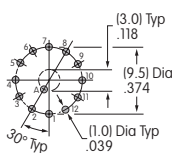

Double Pole  
MRA206

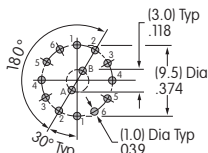

Four Pole  
MRA403

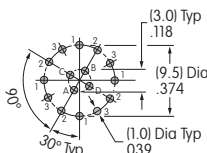

Single Pole  
MRF112  
MRK112

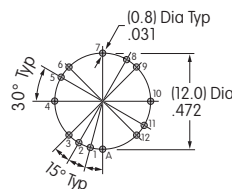

Double Pole  
MRF206  
MRK206

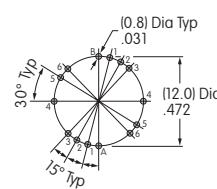

Four Pole  
MRF403  
MRK403

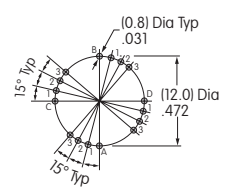

## KNOBS

### A AT433 Plain Black

Material:  
Polyacetal

Color:  
Black  
only

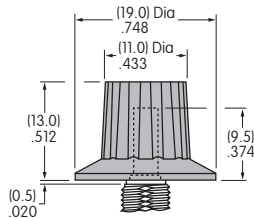

### B AT4103 Small Color Tipped

Base Material:  
Polyester  
Base Color:  
Black

Polyamide Tip  
Colors:  
A, B, C, E, F, G, H

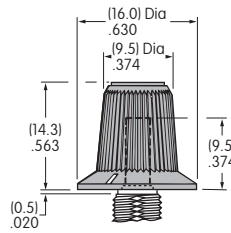

### C AT4104 Large Color Tipped

Base Material:  
Polyester  
Base Color:  
Black

Polyamide Tip  
Colors:  
A, B, C, E, F, G, H

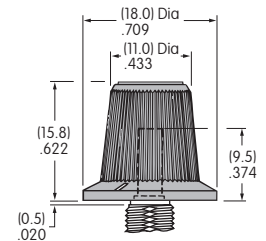

Color Codes: **A** Black **B** White **C** Red **E** Yellow **F** Green **G** Blue **H** Gray

## PANEL CUTOUTS & MAXIMUM EFFECTIVE PANEL THICKNESS

### MRA & MRK

#### Nonsealed Panel

Without  
Keyway

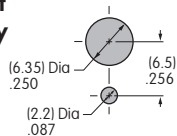

With  
Keyway

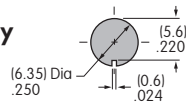

### MRK

#### Sealed Panel

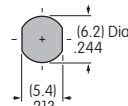

With Standard Hardware on Nonsealed Panel:  
MRA .067" (1.7mm) MRK .087" (2.2mm)

Without Locking Ring on Nonsealed Panel:  
MRA .098" (2.5mm) MRK .118" (3.0mm)

With AT513M & AT535 only on Sealed Panel:  
MRK .106" (2.7mm)

## STANDARD MOUNTING HARDWARE

### AT513M Metric Hexagon Nut

Material:  
Brass, nickel plating  
1 for MRA; 1 for MRK

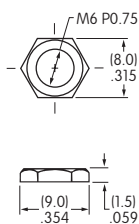

### AT545 Locking Ring

Material:  
Steel, chromate over zinc plating  
1 for MRA; 1 for MRK

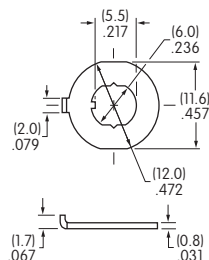

### AT509 Lockwasher

Material:  
Steel, chromate over zinc plating  
1 for MRA; 1 for MRK

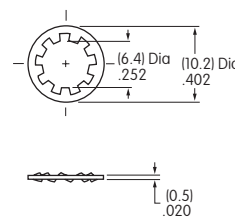

### AT535 Rubber Ring

Material:  
Nitrile butadiene rubber  
1 for MRK

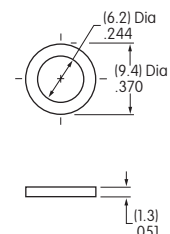

## OPTIONAL SUPPORT BRACKET

### AT543 Support Bracket for MRK

Material:  
Steel with tin plating

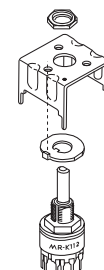
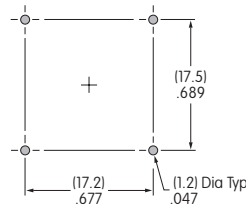
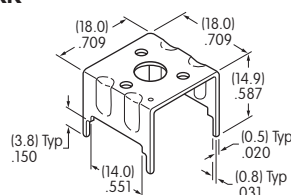

A support bracket is needed when the MRK is mounted only to a PC board and does not have the bushing through a panel.

# General Specifications

## Electrical Capacity (Resistive Load)

<b>For MRX:</b>	2A @ 125V AC or 1A @ 30V DC
<b>For MRY:</b>	For MRY106G: 0.4VA maximum @ 28V AC/DC maximum (Applicable Range 0.1mA ~ 0.1A @ 20mV ~ 28V) Note: See Supplement Index to find explanation of operating range.
	For all other MRY models: 3A @ 125V AC or 2A @ 30V DC
<b>For MRT:</b>	For MRT22: 10A @ 125V AC or 4A @ 30V DC For MRT23: 5A @ 125V AC or 3A @ 30V DC

## Other Ratings

<b>Contact Resistance:</b>	10 milliohms maximum for MRX, MRY, & MRT; 20 milliohms maximum for MRY106G
<b>Insulation Resistance:</b>	100 megohms minimum @ 500V DC for MRX & MRY 200 megohms minimum @ 500V DC for MRT
<b>Dielectric Strength:</b>	1,000V AC minimum for 1 minute minimum
<b>Mechanical Life:</b>	15,000 operations minimum
<b>Electrical Life:</b>	7,500 operations minimum
<b>Range of Operating Torque:</b>	0.03 ~ 0.15Nm for MRX; 0.02 ~ 0.10Nm for MRY; 0.02 ~ 0.05Nm for MRT
<b>Contact Timing:</b>	Nonshorting (break-before-make) MRX: Self-cleaning, sliding contact; MRY: Rotary contactor dish; MRT: Butt contacts
<b>Indexing:</b>	45° for MRX; 60° for MRY; 120° for MRT22; 60° for MRT23

## Materials & Finishes

<b>Shaft:</b>	Brass with nickel plating
<b>Stopper Plate:</b>	Steel with zinc plating for MRX & MRY
<b>Bushing/Housing:</b>	Brass with nickel plating
<b>Movable Contacts:</b>	Silver alloy for MRX & MRT; copper with silver plating for MRY106; copper with gold plating for MRY106G
<b>End Contacts &amp; Terminals:</b>	Silver alloy & copper with silver plating for MRX & MRT; silver alloy plus brass with silver plating for MRY106; silver alloy with gold plating for MRY106G
<b>Common Contacts &amp; Terminals:</b>	Copper with silver plating for MRX, MRY106 & MRT22; brass with gold plating for MRY106G; brass with silver plating for MRT23
<b>Base:</b>	Phenolic resin

## Environmental Data

<b>Operating Temperature Range:</b>	-10°C through +70°C (+14°F through +158°F)
<b>Humidity:</b>	90 ~ 95% humidity for 96 hours @ 40°C (104°F)
<b>Vibration:</b>	10 ~ 55Hz with peak-to-peak amplitude of 1.5mm traversing the frequency range & returning in 1 minute; 3 right angled directions for 2 hours
<b>Shock:</b>	50G (490m/s <sup>2</sup> ) acceleration (tested in 3 right angled directions, with 3 shocks in each direction)

## Installation

<b>Mounting Torque:</b>	.686Nm (6.08 lb•in)
<b>Cap Installation Force:</b>	19.6 ~ 29.4N (4.41 ~ 6.61 lbf)
<b>Soldering Time &amp; Temperature:</b>	Manual Soldering: See Profile A in Supplement section.

## Standards & Certifications

<b>UL:</b>	<b>File No. E44145 - Recognized only when ordered with marking on switch.</b> Add "/U" or "/CUL" before dash in part number to order UL recognized switch. MRT22 models recognized at 10A @ 125V AC; MRT23 models recognized at 5A @ 125V AC
------------	--

# Distinctive Characteristics

Positive detent mechanism for distinct feel and audible feedback.

Metal bushing and housing construction increases durability.

Adjustable stopper plate allows 2-8 position settings.

High contact reliability achieved by the self-cleaning contact mechanism.

Break-before-make contact timing with various mechanism types: sliding contacts in MRX, contactor dish in MRY, and butt contacts in MRT models.

Terminal types include PC-turret for MRX, turret for MRY, and solder lug for MRT models.

Molded-in PC-turret and turret terminals prevent entry of flux and other contaminants.

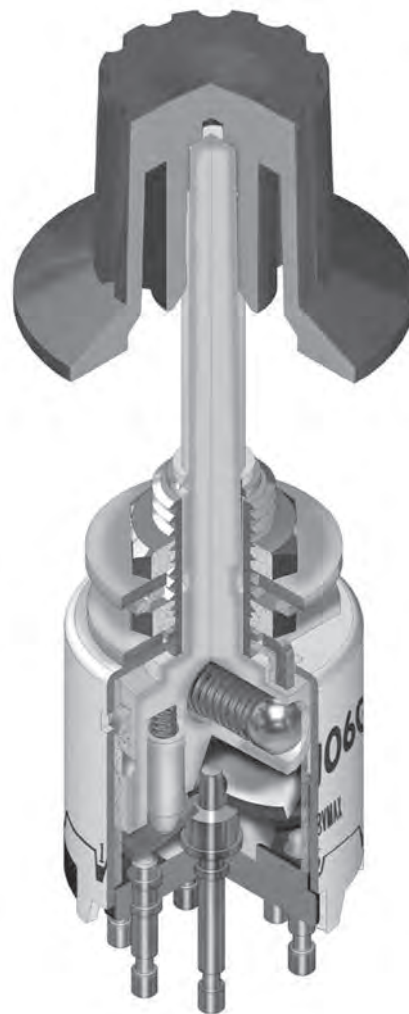

Actual Size

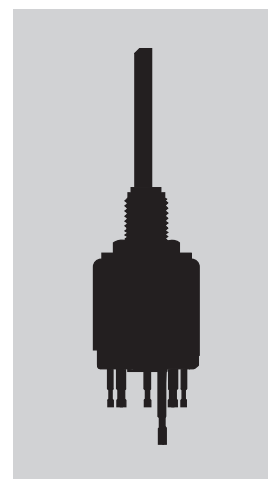

Toggle

Rockers

Pushbuttons

Illuminated PB

Programmable

Key locks

**G** Rotaries

Slides

Tactiles

Tilt

Touch

Indicators

Accessories

Supplement

### TYPICAL SWITCH ORDERING EXAMPLE

MR

X

108

A



#### Actuators & Terminals

#### Poles & Circuits

#### Knobs

#### Colors

X Shaft Actuated with PC-Turret Terminals

108	SP with 2-8 Positions
204	DP with 2-4 Positions
402	4P with 2 Positions

A	Plain Black
B	Small Color Tipped
C	Large Color Tipped

For Plain Knob	
No Code	Black
For Color Tipped	
A	Black
B	White
C	Red
E	Yellow
F	Green
G	Blue
H	Gray

Y Shaft Actuated with Turret Terminals

106	SP with 2-6 Positions
106G	SP with 2-6 Positions Gold Contacts 0.4VA

T Shaft Actuated with Solder Lug Terminals

22	DPDT ON-NONE-ON
23	DPDT ON-OFF-ON

### DESCRIPTION FOR TYPICAL ORDERING EXAMPLE

MRX108-A

Shaft Actuated with Plain Black Knob

SP with 2-8 Adjustable Positions

PC-Turret Terminals



#### IMPORTANT:

MRT Switches are supplied without UL & cULus marking unless specified.

**UL & cULus recognized only when ordered with marking on the switch.**

Specific models, ratings, & ordering instructions are noted on the General Specifications page.



### ACTUATORS & TERMINALS

X Shaft Actuated with PC-Turret Terminals

Y Shaft Actuated with Turret Terminals

T Shaft Actuated with Solder Lug Terminals

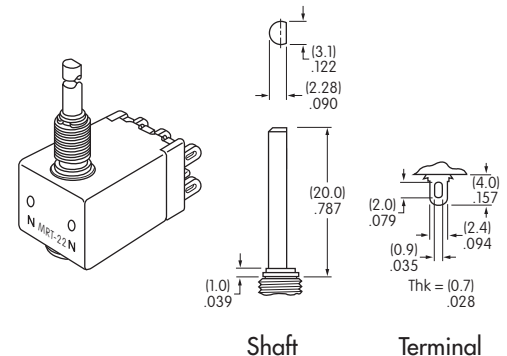
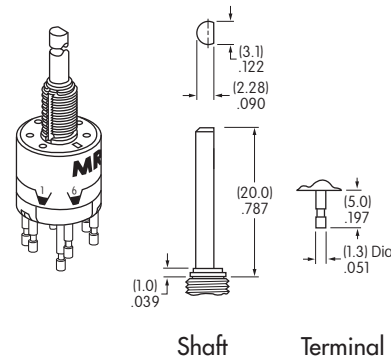
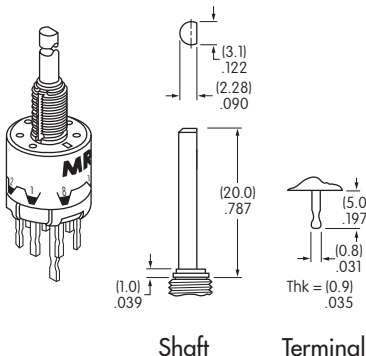



POLES & CIRCUITS					
Pole	Model	Number of Positions	Stopper Settings	Number of Terminals	Schematics
SP	MRX108	2-8	2, 3, 4, 5, 6, 7, 8	1 COM, 8 LOAD	
	MRY106 MRY106G	2-6	2, 3, 4, 5, 6	1 COM, 6 LOAD	
DP	MRX204	2-4	2, 3, 4	2 COM, 8 LOAD	
DPDT	MRT22	2	ON-NONE-ON	2-3 2-1 5-6 5-4	
	MRT23	3	ON-OFF-ON	2-3 OPEN 2-1 5-6 OPEN 5-4	
4P	MRX402	2	1 & 2	4 COM, 8 LOAD	

## POSITION SETTING FOR MRX & MRY MODELS

Each switch is supplied with the stopper set for the maximum number of positions allowed for that model. Prior to installation, the desired position setting should be made. Contact factory for continuous rotation.

- Using the actuator knob, turn the shaft counterclockwise to the extreme left. If the shaft is not turned to this extreme position where the white line on the knob points to the number 1 position shown on the side of the switch, proper setting cannot be achieved.
- Remove the knob from the shaft and loosen the nut far enough to allow raising the stopper plate for resetting to the desired position.
- Note the position numbers on the side of the switch; these correspond to the terminal numbers and stopper holes. Insert the stopper in the hole numbered for the maximum desired number of stop settings. Satisfactory switch functioning cannot be assured if the stopper plate is not properly positioned.
- Tighten the nub (beveled side up) firmly against the stopper plate.

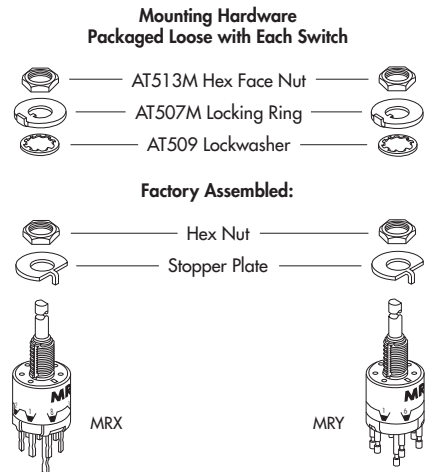

## TYPICAL SWITCH DIMENSIONS

### Single, Double & Four Pole

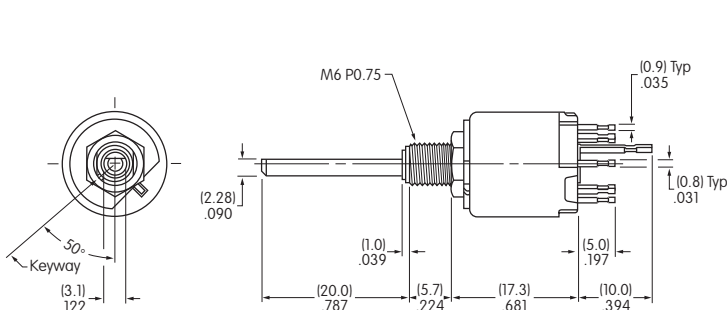

### MRX • PC-Turret Terminals

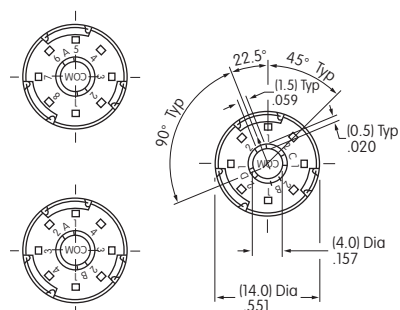

MRX108

## TYPICAL SWITCH DIMENSIONS

### MRY • Turret Terminals

### Single Pole

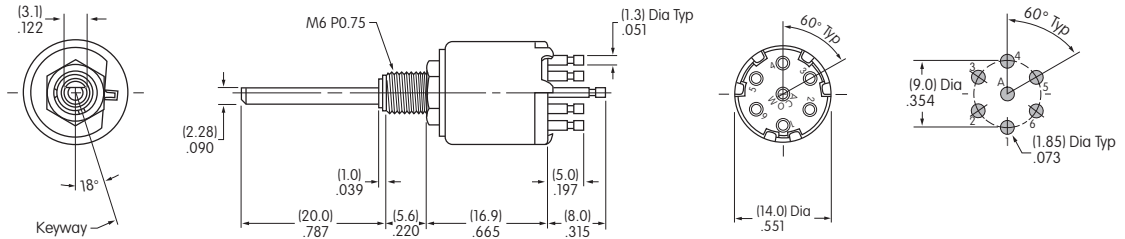

**MRY106**

### MRT • Solder Lug Terminals

### Double Pole

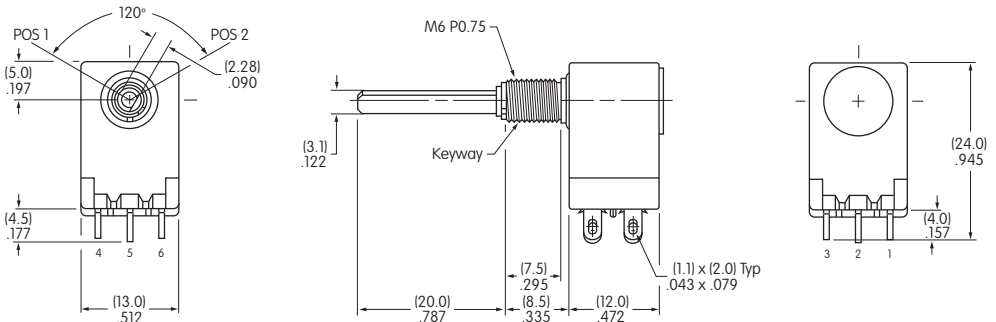

**MRT22**

### MRT • Solder Lug Terminals

### Double Pole

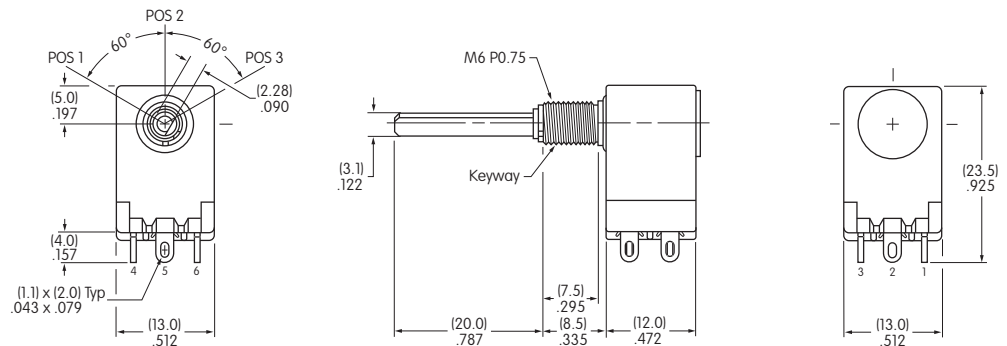

**MRT23**

PC FOOTPRINTS FOR MRX SINGLE, DOUBLE, & FOUR POLE

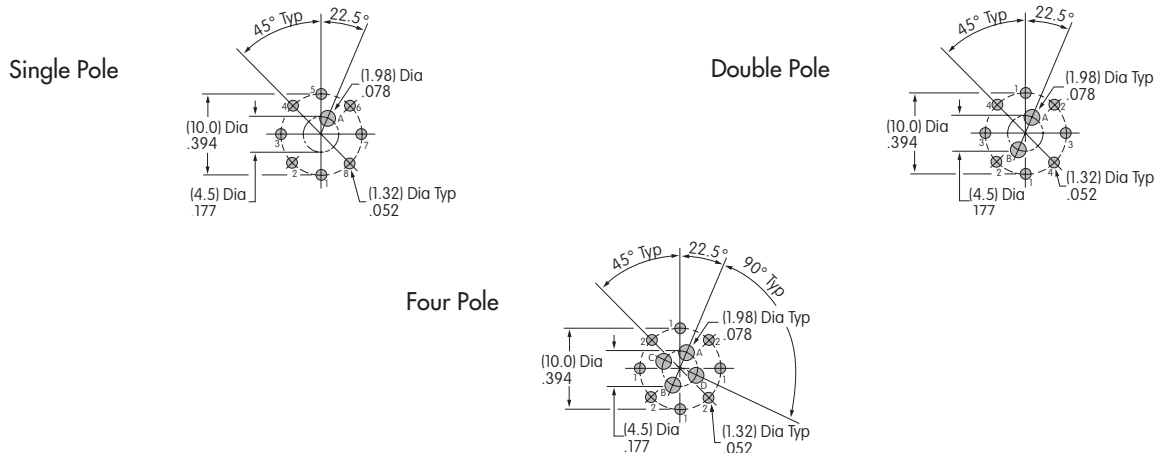

KNOBS

**A** AT433 Plain Black

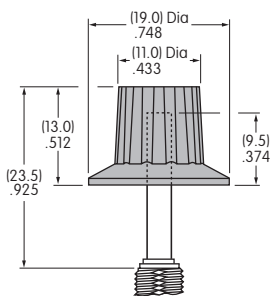

Material: Polyacetal  
Color: Black only

**B** AT4103 Small Color Tipped

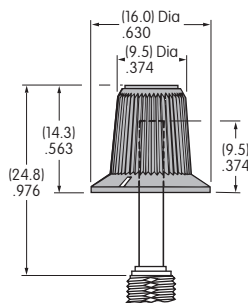

Base Material: Polyester  
Base Color: Black  
Polyamide Tip  
Colors: A, B, C, E, F, G, H

**C** AT4104 Large Color Tipped

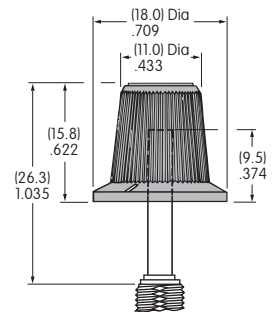

Base Material: Polyester  
Base Color: Black  
Polyamide Tip  
Colors: A, B, C, E, F, G, H

Color Codes: **A** Black **B** White **C** Red **E** Yellow **F** Green **G** Blue **H** Gray

PANEL CUTOUTS & MAXIMUM EFFECTIVE PANEL THICKNESS

Without Keyway

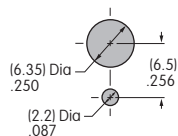

With Keyway

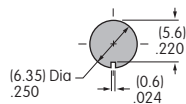

Maximum Effective Panel Thickness

With Standard Hardware: MRX & MRY .095" (2.4mm); MRT .106" (2.7mm)  
Without Locking Ring: MRX & MRY .126" (3.2mm); MRT .138" (3.5mm)

# General Specifications

## Electrical Capacity (Resistive Load)

**Logic Level:** 0.4VA maximum @ 28V AC/DC maximum  
(Applicable Range 0.1 mA ~ 0.1A @ 20mV ~ 28V)  
Note: See Supplement Index to find explanation of operating range.

## Other Ratings

**Contact Resistance:** 80 milliohms maximum  
**Insulation Resistance:** 100 megohms minimum @ 500V DC  
**Dielectric Strength:** 500V AC minimum for 1 minute minimum  
**Mechanical Life:** 30,000 operations minimum  
**Electrical Life:** 10,000 operations minimum  
**Operating Torque:** 0.04Nm average  
**Contact Timing:** Nonshorting (break-before-make)  
**Indexing:** 45° for On-On-On & 90° for On-None-On

## Materials & Finishes

**Shaft:** Brass with nickel plating  
**Bushing:** Zinc alloy with nickel plating  
**Frame/Bracket:** Steel with tin plating  
**Movable Contacts:** Beryllium copper spring with gold plating  
**Stationary Contacts:** Copper with gold plating  
**Terminals:** Brass with tin plating  
**Base:** Polyamide

## Environmental Data

**Operating Temperature Range:** -10°C through +70°C (+14°F through +158°F)  
**Humidity:** 90 ~ 95% humidity for 96 hours @ 40°C (104°F)  
**Vibration:** 10 ~ 55Hz with peak-to-peak amplitude of 1.5mm traversing the frequency range & returning in 1 minute; 3 right angled directions for 2 hours  
**Shock:** 50G (490m/s<sup>2</sup>) acceleration (tested in 3 right angled directions, with 5 shocks in each direction)  
**Sealing:** Use of optional o-ring AT535 with MRB meets IP67 of IEC60529 specifications

## Installation

**Mounting Torque:** .686Nm (6.08 lb•in)  
**Cap Installation Force:** 19.6 ~ 29.4N (4.41 ~ 6.61 lbf)

## PCB Processing

**Soldering:** Wave Soldering Recommended: See Profile B in Supplement section  
Manual Soldering: See Profile B in Supplement section  
**Cleaning:** Automated cleaning. See Cleaning specifications in Supplement section.

## Standards & Certifications

The MRB Series rotaries have not been tested for UL recognition or CSA certification. These switches are designed for use in a low-voltage, low-current, logic-level circuit. When used as intended in a logic-level circuit, the results do not produce hazardous energy.

# Distinctive Characteristics

Double flatted bushing prevents rotation in panel and increases stability.

Totally sealed construction, achieved with combination of an interior o-ring, a seal between the frame and base, plus insert molded terminals, prevents contact contamination and allows automated soldering and cleaning.

Positive detent mechanism for distinct feel and audible feedback.

Break-before-make contact timing with sliding contact mechanism.

Metal bushing and frame/bracket provide durability.

Panel seal, achieved with use of optional exterior o-ring, conforms to IP67 of IEC60529 Standards.

High contact reliability achieved by the self-cleaning contact mechanism.

.100" x .100" (2.54mm x 2.54mm) terminal spacing conforms to standard PC board grid spacing for straight and right angle mounting.

Insert molded terminals lock out flux and other contaminants.

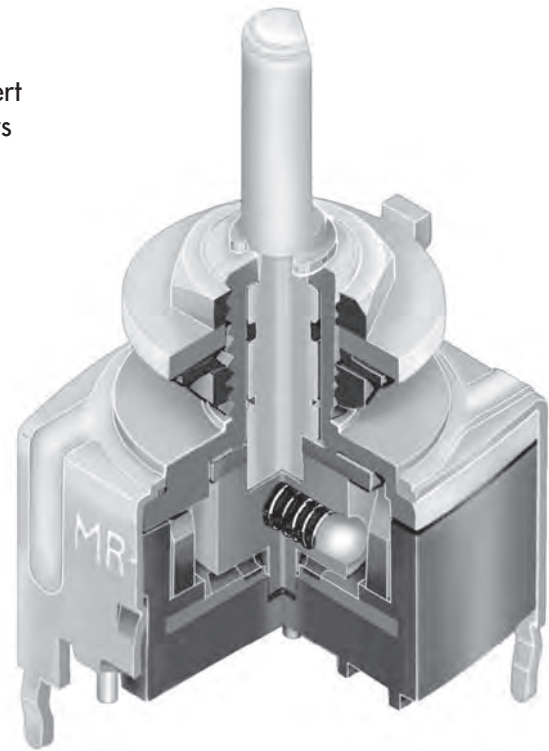

Actual Size

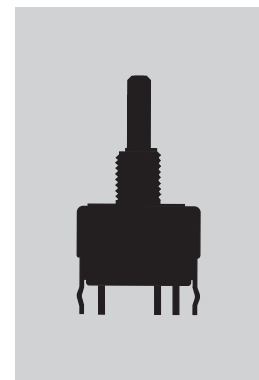

Toggle

Rockers

Pushbuttons

Illuminated PB

Programmable

Key locks

**G** Rotaries

Slides

Tactiles

Tilt

Touch

Indicators

Accessories

Supplement

### TYPICAL SWITCH ORDERING EXAMPLE

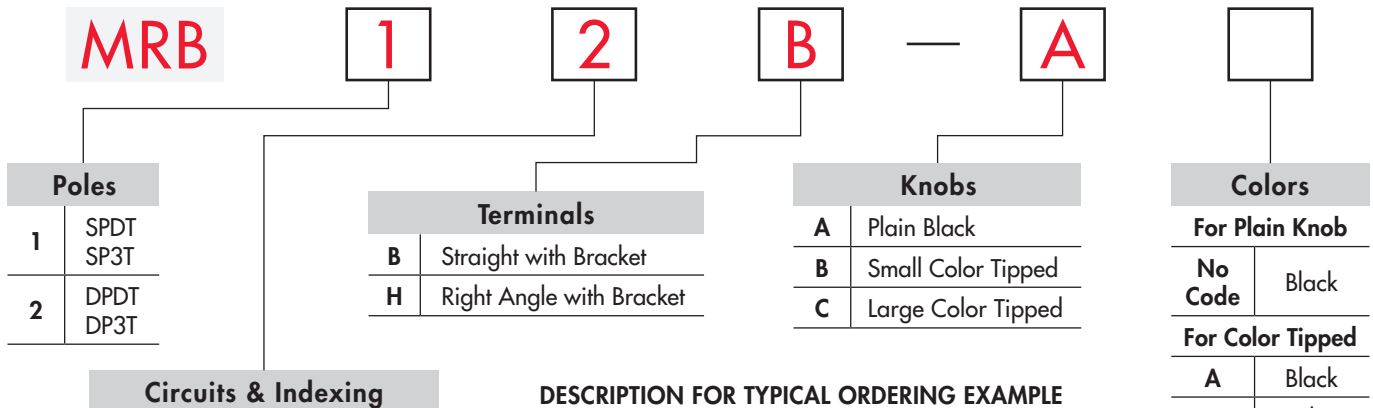

Poles	
1	SPDT SP3T
2	DPDT DP3T

Terminals	
B	Straight with Bracket
H	Right Angle with Bracket

Knobs	
A	Plain Black
B	Small Color Tipped
C	Large Color Tipped

Colors	
For Plain Knob	
No Code	Black
For Color Tipped	
A	Black
B	White
C	Red
E	Yellow
F	Green
G	Blue
H	Gray

Circuits & Indexing				
2	ON	NONE	ON	90°
4	ON	ON	ON	45°

### DESCRIPTION FOR TYPICAL ORDERING EXAMPLE

**MRB12B-A**



### POLES & CIRCUITS

Pole	Model	Actuator Positions			Connected Terminals			Throw & Schematics
		Position 1	Position 2	Position 3	Position 1	Position 2	Position 3	Note: Terminal numbers are not actually on switch
SP	MRB12	ON	NONE	ON	C1-1	OPEN	C1-2	SPDT
	MRB14	ON	ON	ON	C1-1	C1-2	C1-3	SP3T
DP	MRB22	ON	NONE	ON	C1-1 C2-4	OPEN	C1-2 C2-5	DPDT
	MRB24	ON	ON	ON	C1-1 C2-4	C1-2 C2-5	C1-3 C2-6	DP3T

### TERMINALS

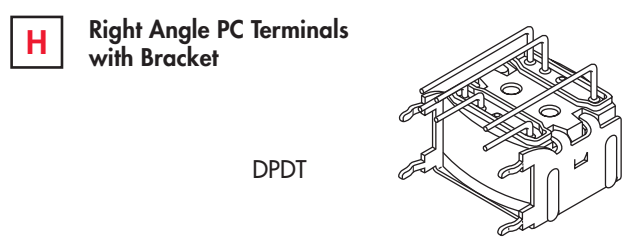
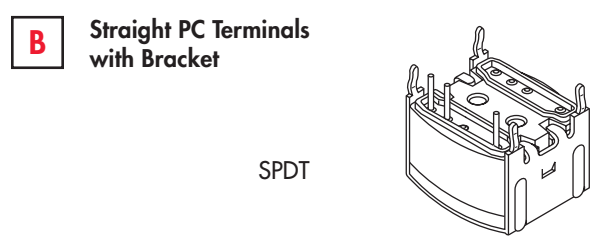

Toggles  
 Rockers  
 Pushbuttons  
 Illuminated PB  
 Programmable  
 Keylocks  
 Rotaries  
 Slides  
 Tactiles  
 Tilt  
 Touch  
 Indicators  
 Accessories  
 Supplement

## TYPICAL SWITCH DIMENSIONS

### 90° Indexing • SPDT & DPDT • Straight PC

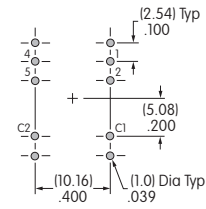
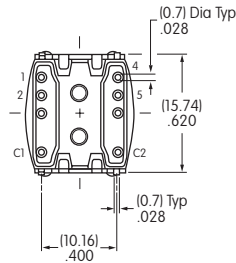
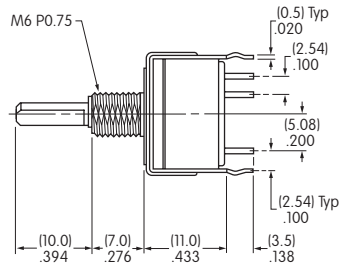
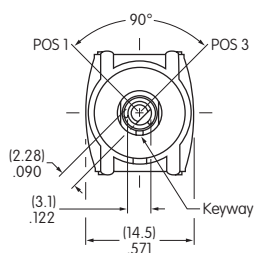

Actuator shown in Position 1

Single pole model does not have terminals 4, 5 & C2

**MRB12B**

### 90° Indexing • SPDT • Right Angle PC

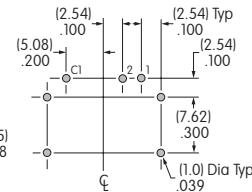
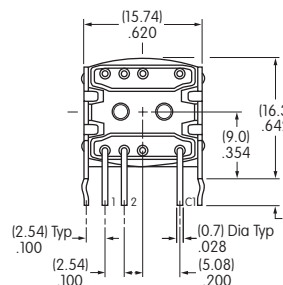
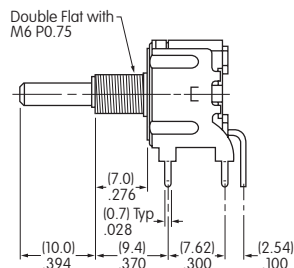
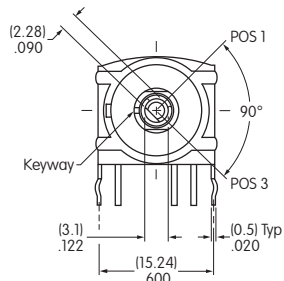

Actuator shown in Position 1

**MRB12H**

### 90° Indexing • DPDT • Right Angle PC

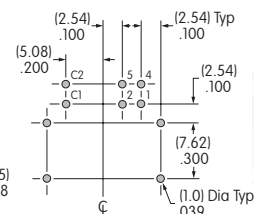
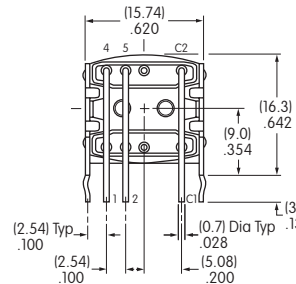
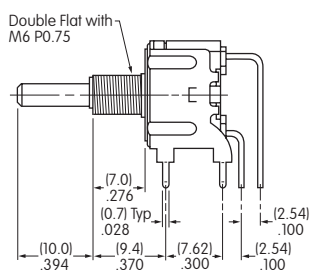
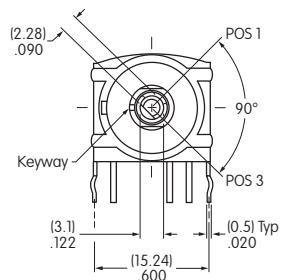

Actuator shown in Position 1

**MRB22H**

### 45° Indexing • SP3T & DP3T • Straight PC

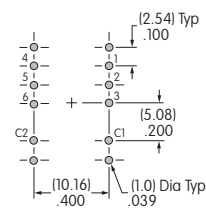
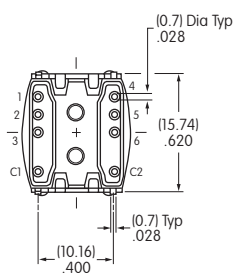
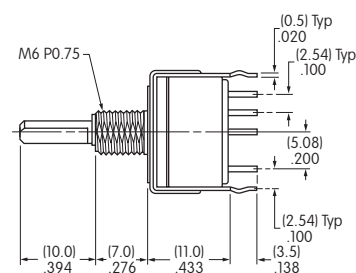
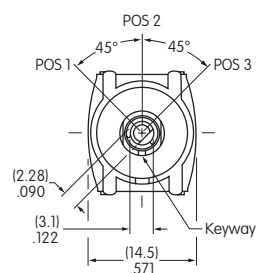

Actuator shown in Position 1

Single pole model does not have terminals 4, 5, 6 & C2

**MRB14B**

## TYPICAL SWITCH DIMENSIONS

### 45° Indexing • SP3T • Right Angle PC

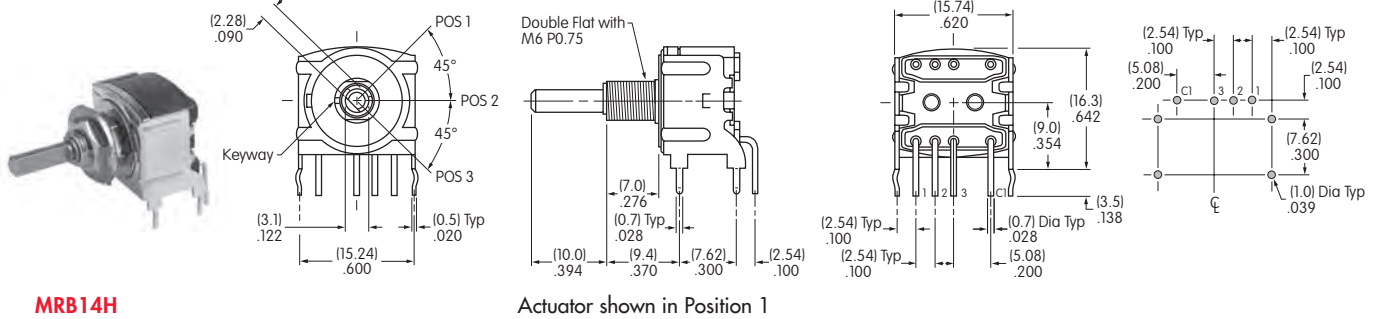

### 45° Indexing • DP3T • Right Angle PC

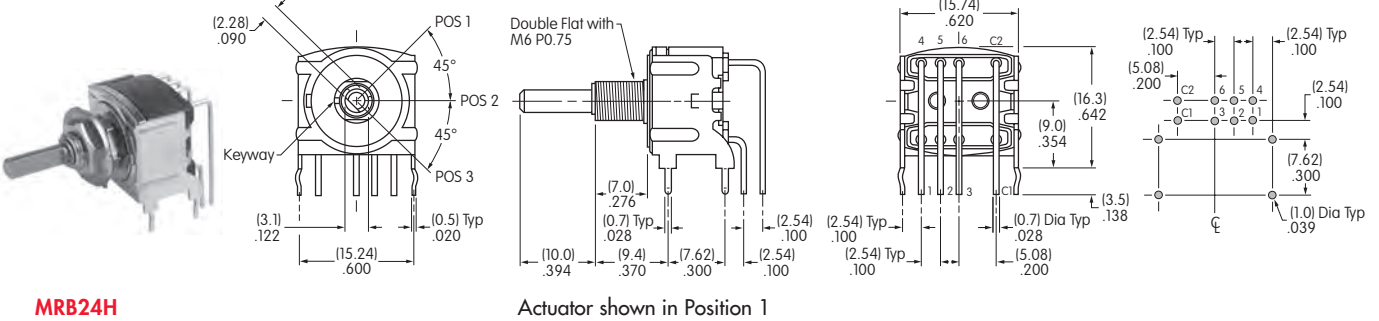

## KNOBS

### A AT433 Plain Black

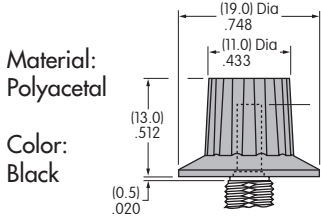

### B AT4103 Small Color Tipped

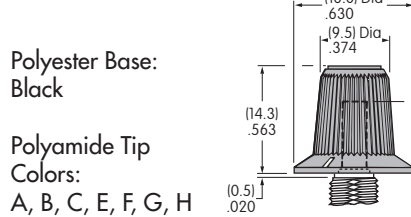

### C AT4104 Large Color Tipped

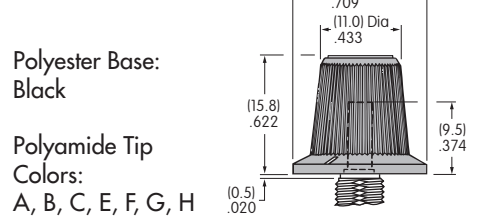

Color Codes: **A** Black **B** White **C** Red **E** Yellow **F** Green **G** Blue **H** Gray

### Shaft Detail

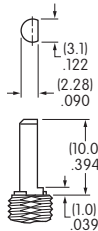

### Mounting Precaution for Cap Clearance on Right Angle Models

When mounting a right angle switch, a cap clearance of .035" (0.9mm) is recommended.

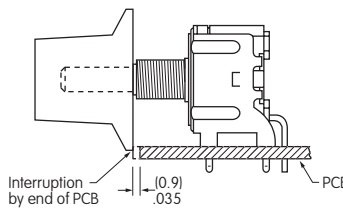

### Standard Hardware Supplied

AT513M Hex Nut  
AT545 Locking Ring  
AT509 Lockwasher  
**Optional Hardware**  
AT535 O-ring for Panel Seal  
See Supplement for details

## PANEL CUTOUTS & MAXIMUM EFFECTIVE PANEL THICKNESS

With Standard Hardware  
.087" (2.2mm)

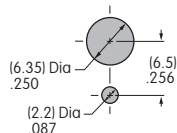

Without Locking Ring  
.118" (3.0mm)

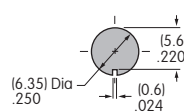

Sealed Panel with 1 Hex Nut & 1 Rubber O-ring  
.165" (4.2mm)

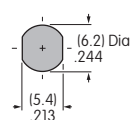





# General Specifications

## Electrical Capacity (Resistive Load)

<b>Switching Rating:</b>	100mA @ 5V DC
<b>Nonswitching Rating:</b>	100mA @ 50V DC

## Other Ratings

<b>Contact Resistance:</b>	80 milliohms maximum for circuit; 30 milliohms maximum for contact point
<b>Insulation Resistance:</b>	1,000 megohms minimum @ 250V DC
<b>Dielectric Strength:</b>	250V AC minimum for 1 minute minimum
<b>Mechanical Life:</b>	20,000 detent operations minimum
<b>Electrical Life:</b>	20,000 detent operations minimum

Notes: A detent operation is one actuator position operation or stepping.  
20,000 detent operations = 1,250 cycles for hexadecimal devices or 2,000 cycles for decimal devices. A cycle is one 360° rotation.

<b>Nominal Operating Torque:</b>	0.006Nm
<b>Contact Timing:</b>	Nonshorting (break-before-make)

## Materials & Finishes

<b>Actuator:</b>	Glass fiber reinforced polyamide
<b>Housing:</b>	Glass fiber reinforced polyamide (UL94V-0)
<b>O-ring:</b>	Nitrile butadiene rubber
<b>Base:</b>	Glass fiber reinforced polyamide (UL94V-0)
<b>Movable Contact:</b>	Beryllium copper with gold plating
<b>Stationary Contacts:</b>	Brass with gold plating
<b>Terminals:</b>	Brass with gold plating

## Environmental Data

<b>Operating Temperature Range:</b>	-25°C through +75°C (-13°F through +167°F)
<b>Humidity:</b>	90 ~ 95% humidity for 96 hours @ 40°C (104°F)
<b>Vibration:</b>	10 ~ 55Hz with peak-to-peak amplitude of 1.5mm traversing the frequency range & returning in 1 minute; 3 right angled directions for 2 hours
<b>Shock:</b>	50G (490m/s <sup>2</sup> ) acceleration (tested in 6 right angled directions, with 5 shocks in each direction)

## Processing

<b>Soldering:</b>	Wave Soldering Recommended: See Profile B in Supplement section. Note: During Wave Soldering process, set the switch to the following position: NDFR10, NDFR16, NDKR10, NDKR16: 0 position; NDFC10, NDKC10: 7 position; NDFC16, NDKC16: F position. Manual Soldering: See Profile B in Supplement section.
<b>Cleaning:</b>	Automated Cleaning. See Cleaning Specifications in Supplement section.

## Standards & Certifications

<b>Flammability Standards:</b>	UL94V-0 rated housing & base The ND Series rotaries have not been tested for UL recognition or CSA certification. These switches are designed for use in a low-voltage, low-current, logic-level circuit. When used as intended in a logic-level circuit, the results do not produce hazardous energy.
--------------------------------	---

# Distinctive Characteristics

Sealed construction prevents contact contamination and allows automated soldering and cleaning. Sealed design accomplished with seals between the actuator and housing and between housing and base.

Highly visible legends and choice of screwdriver or shaft actuation to provide trouble-free code setting.

Detent mechanism designed for crisp, positive action for accurate switch setting.

Bifurcated, spring loaded contacts give unmatched logic-level reliability.

Heat tolerant resin used for body meets UL flammability rating of 94V-0 and maintains switch reliability through automated soldering process.

Crimped terminals ensure secure PC mounting and prevent dislodging during soldering.

.100" (2.54mm) terminal grid spacing between pin centers, plus 3-by-3 terminal arrangement for footprint pattern equivalent to industry standard.

Epoxy sealed terminals lock out flux, solvents, and other contaminants.



Actual Size

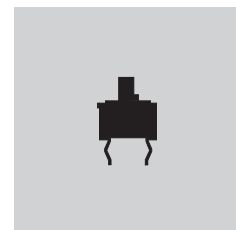

### TYPICAL SWITCH ORDERING EXAMPLE

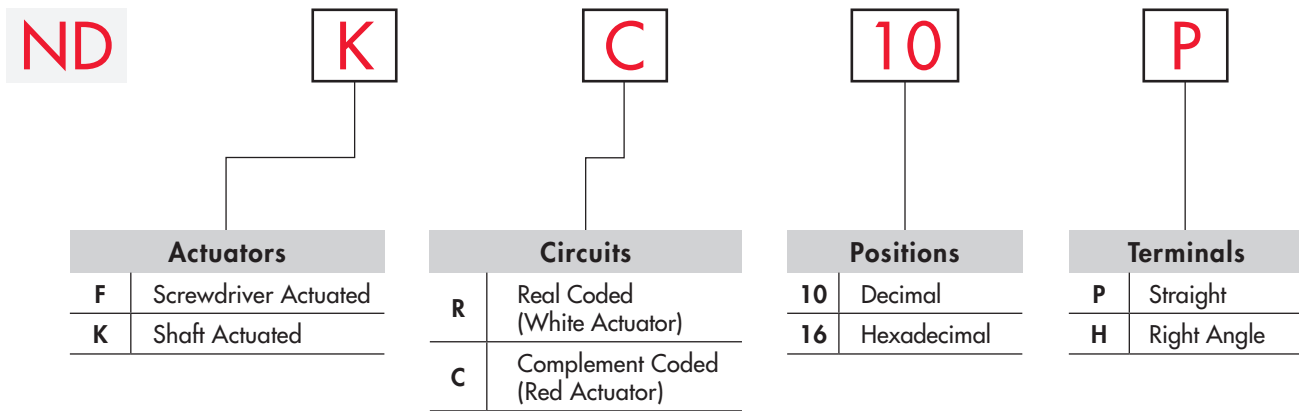

### DESCRIPTION FOR TYPICAL ORDERING EXAMPLE

**NDKC10P**

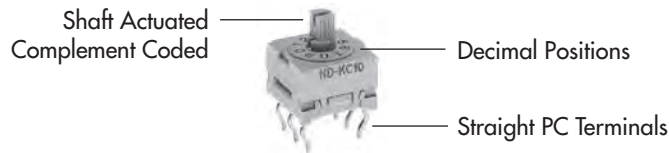

### ACTUATORS

**F** Screwdriver Actuated

Actuator colors:  
White for real coded  
Red for complement coded

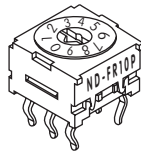

**K** Shaft Actuated

Actuator colors:  
White for real coded  
Red for complement coded

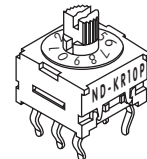

Actuators are fully rotational in either direction.

### TRUTH TABLES (CIRCUITS & POSITIONS)

Terminal No. (Output)	Actuator Position ● = ON	10 Decimal									16 Hexadecimal																		
		0	1	2	3	4	5	6	7	8	9	0	1	2	3	4	5	6	7	8	9	A	B	C	D	E	F		
<b>R</b> Real Coded Model Numbers: NDFR, NDKR	1		●		●		●		●		●		●		●		●		●		●		●		●		●		●
	2			●	●			●	●				●	●			●	●			●	●			●	●			●
	4					●	●	●	●						●	●	●	●					●	●	●	●			
	8									●	●									●	●	●	●						
<b>C</b> Complement Coded Model Numbers: NDFC, NDKC	1	●		●		●		●		●		●		●		●		●		●		●		●		●		●	
	2	●	●			●	●			●	●			●	●			●	●			●	●			●	●		
	4	●	●	●	●					●	●	●	●							●	●	●	●						
	8	●	●	●	●	●	●	●			●	●	●	●	●	●	●	●											

TYPICAL SWITCH DIMENSIONS

Screwdriver Actuated • Straight PC

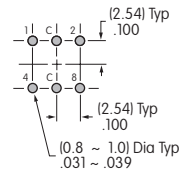
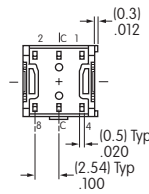
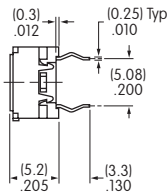
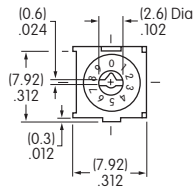

Terminal numbers are not on switch

NDFR10P

Shaft Actuated • Straight PC

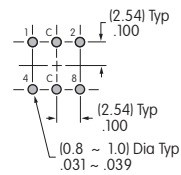
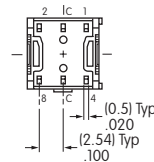
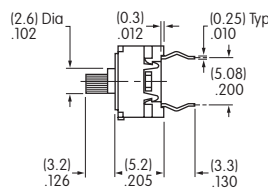
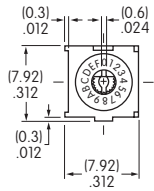

Terminal numbers are not on switch

NDKC16P

Screwdriver Actuated • Right Angle PC

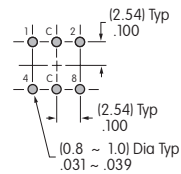
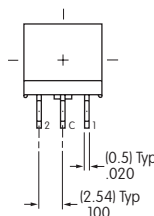
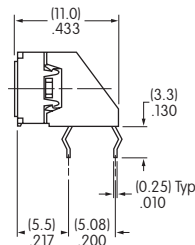
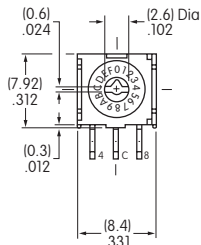

Terminal numbers are on terminal cover

NDFC16H

Shaft Actuated • Right Angle PC

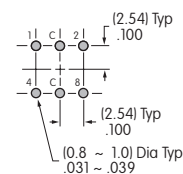
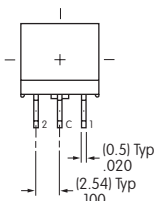
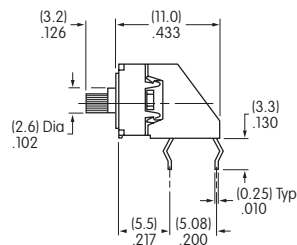
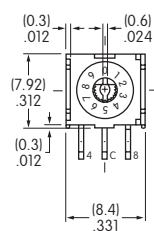

Terminal numbers are on terminal cover

NDKR10H

# General Specifications

## Electrical Capacity (Resistive Load)

<b>Switching Rating:</b>	100mA @ 5V DC
<b>Nonswitching Rating:</b>	100mA @ 50V DC

## Other Ratings

<b>Contact Resistance:</b>	80 milliohms maximum for circuit; 30 milliohms maximum for contact point
<b>Insulation Resistance:</b>	1,000 megohms minimum @ 250V DC
<b>Dielectric Strength:</b>	250V AC minimum for 1 minute minimum
<b>Mechanical Life:</b>	20,000 detent operations minimum
<b>Electrical Life:</b>	20,000 detent operations minimum
	Note: A detent operation is one actuator position operation or stepping. 20,000 detent operations = 1,250 cycles for hexadecimal devices or 2,000 cycles for decimal devices. A cycle is one 360° rotation.
<b>Nominal Operating Torque:</b>	.061 kgf/cm (.846 oz/in)
<b>Contact Timing:</b>	Nonshorting (break-before-make)

## Materials & Finishes

<b>Actuator:</b>	Glass fiber reinforced polyamide
<b>Housing:</b>	Glass fiber reinforced polyamide (UL94V-0)
<b>O-ring:</b>	Nitrile butadiene rubber
<b>Base:</b>	Glass fiber reinforced polyamide (UL94V-0)
<b>Movable Contact:</b>	Beryllium copper with gold plating
<b>Stationary Contacts:</b>	Brass with gold plating
<b>Terminals:</b>	Brass with gold plating

## Environmental Data

<b>Operating Temperature Range:</b>	-25°C through +85°C (-13°F through +185°F)
<b>Humidity:</b>	90 ~ 95% humidity for 100 hours @ 40°C (104°F)
<b>Vibration:</b>	10 ~ 55Hz with peak-to-peak amplitude of 1.5mm traversing the frequency range & returning in 1 minute; 3 right angled directions for 2 hours
<b>Shock:</b>	50G (490m/s <sup>2</sup> ) acceleration (tested in 6 right angled directions, with 5 shocks in each direction)

## Processing

<b>Soldering:</b>	Reflow Soldering: See Profile B in Supplement section. Note: During Reflow Soldering process, set the switch to the following position: ND3FR10, ND3FR16, ND3KR10, ND3KR16: 0 position; ND3FC10, ND3KC10: 7 position; ND3FC16, ND3KC16: F position. Manual Soldering: See Profile B in Supplement section.
<b>Cleaning:</b>	Automated cleaning. See Cleaning Specifications in Supplement section.

## Standards & Certifications

<b>Flammability Standards:</b>	UL94V-0 rated housing & base The ND3 Series rotaries have not been tested for UL recognition or CSA certification. These switches are designed for use in a low-voltage, low-current, logic-level circuit. When used as intended in a logic-level circuit, the results do not produce hazardous energy.
--------------------------------	--

# Distinctive Characteristics

Sealed construction prevents contact contamination and allows vapor phase and IR reflow soldering. Sealed design accomplished with seals between the actuator and housing and between housing and base.

Highly visible legends and choice of screwdriver or shaft actuation to provide trouble-free code setting.

Detent mechanism designed for crisp, positive action for accurate switch setting.

Bifurcated, spring loaded contacts give unmatched logic-level reliability.

Heat tolerant resin used for body meets UL flammability rating of 94V-0 and maintains switch reliability through vapor phase and infrared convection reflow soldering.

Gull-winged terminals ensure mechanical stability during soldering and simplified solder joint inspection.

.100" (2.54mm) terminal grid spacing between pin centers, plus 3-by-3 terminal arrangement for pad layout pattern equivalent to industry standard.

Epoxy sealed terminals lock out flux, solvents, and other contaminants.

Packaging in tape-reel or partitioned tray. Tape-reel packaging meets EIA-481-D Standard.

Coplanarity: all considered surfaces must lie between two parallel planes that are a maximum distance apart of .0059" (0.15mm). (Additional coplanarity details in Terms and Acronyms in the Supplement section.)

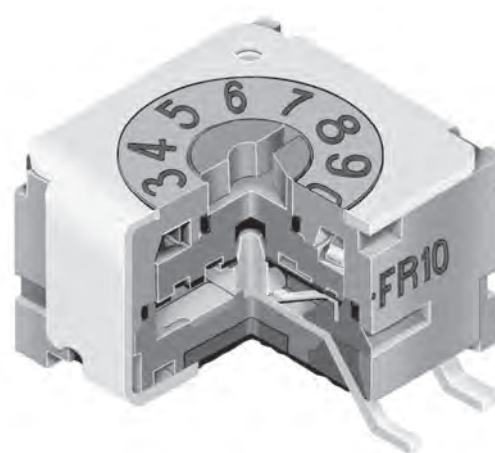

Actual Size

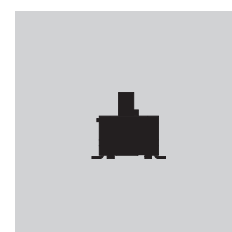

### TYPICAL SWITCH ORDERING EXAMPLE

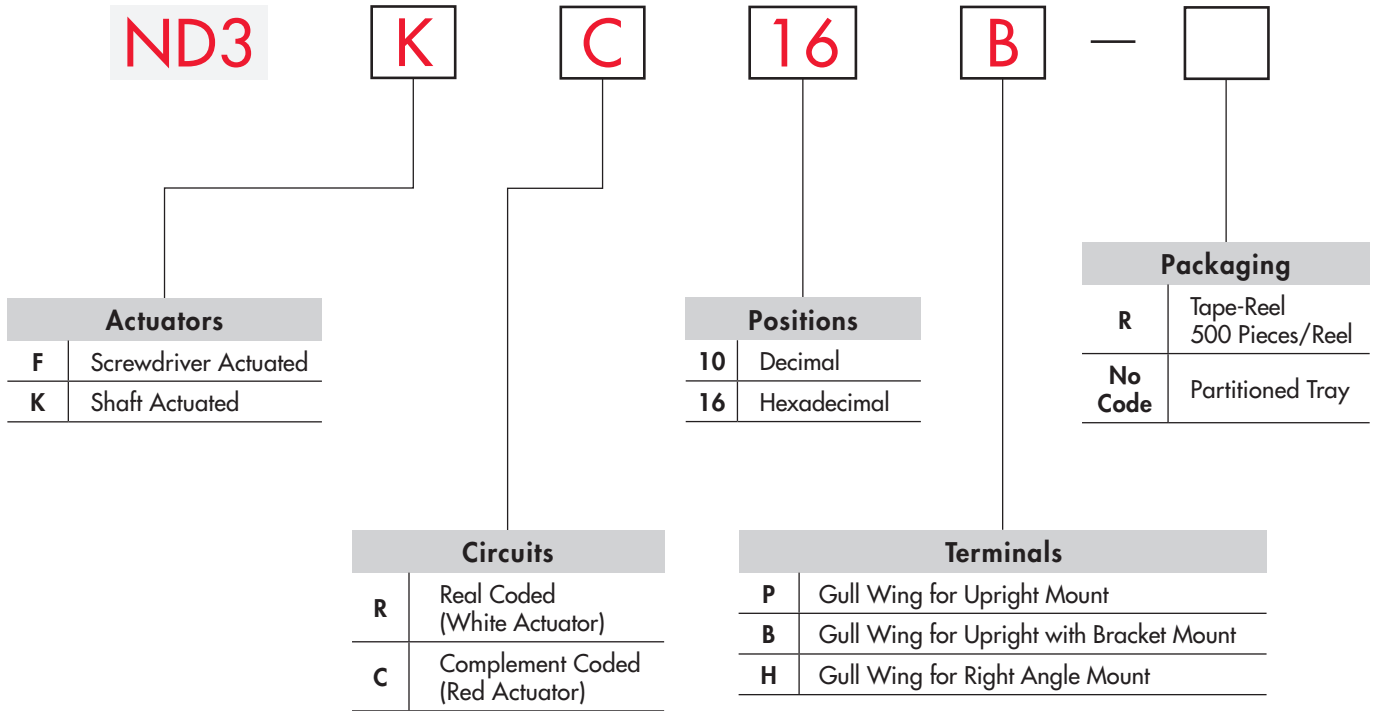

### DESCRIPTION FOR TYPICAL ORDERING EXAMPLE

**ND3KC16B**



### ACTUATION

**F** Screwdriver Actuated

**K** Shaft Actuated

Actuator colors:  
White for real coded  
Red for complement coded

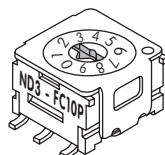

Actuator colors:  
White for real coded  
Red for complement coded

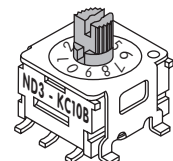

Actuators are fully rotational in either direction.



TRUTH TABLES (CIRCUITS & POSITIONS)

Terminal No. (Output)	Actuator Position ● = ON	10 Decimal								16 Hexadecimal																			
		0	1	2	3	4	5	6	7	8	9	0	1	2	3	4	5	6	7	8	9	A	B	C	D	E	F		
<b>R</b> Real Coded Model Numbers: ND3FR, ND3KR	1		●		●		●		●		●		●		●		●		●		●		●		●		●		●
	2			●	●			●	●			●	●			●	●			●	●			●	●			●	●
	4					●	●	●	●					●	●	●	●					●	●	●	●				
	8									●	●									●	●								
<b>C</b> Complement Coded Model Numbers: ND3FC, ND3KC	1	●		●		●		●		●		●		●		●		●		●		●		●		●		●	
	2	●	●			●	●			●	●			●	●			●	●			●	●			●	●		
	4	●	●	●	●					●	●	●	●							●	●	●	●						
	8	●	●	●	●	●	●	●	●					●	●	●	●	●	●										

TYPICAL SWITCH DIMENSIONS

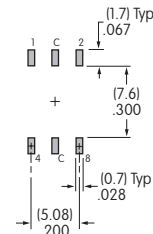
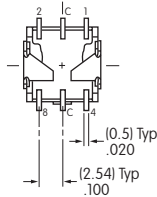
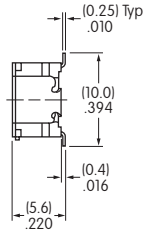
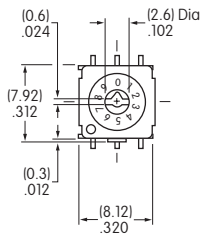

Screwdriver Actuated • Upright

Terminal numbers are not on switch.

ND3FR10P

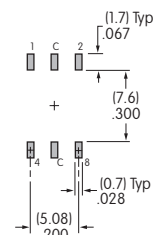
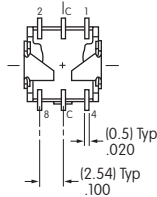
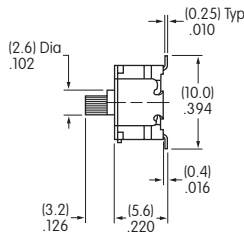
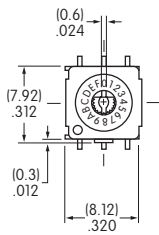

Shaft Actuated • Upright

Terminal numbers are not on switch.

ND3KC16P

Screwdriver Actuated • Upright with Bracket

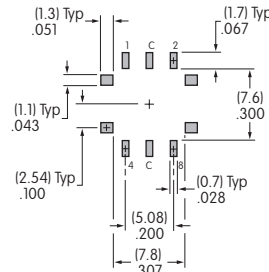
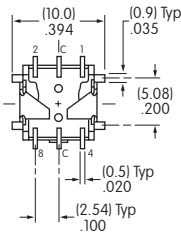
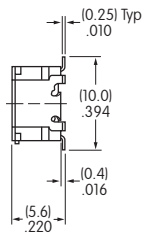
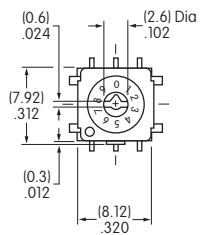

Terminal numbers are not on switch.

ND3FR10B

## TYPICAL SWITCH DIMENSIONS

### Shaft Actuated • Upright with Bracket

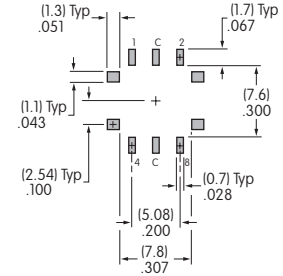
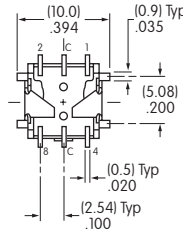
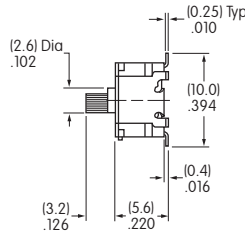
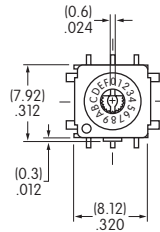

**ND3KC16B**

Terminal numbers are not on switch.

### Screwdriver Actuated • Right Angle

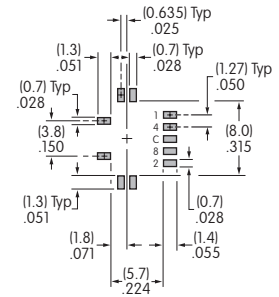
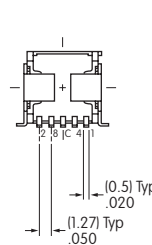
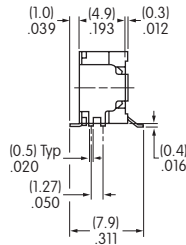
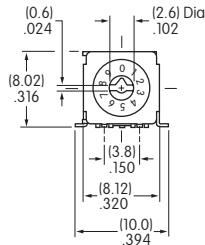

**ND3FC10H**

Terminal numbers are not on switch.

### Shaft Actuated • Right Angle

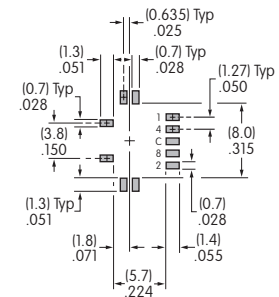
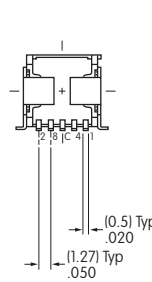
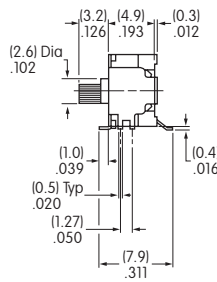
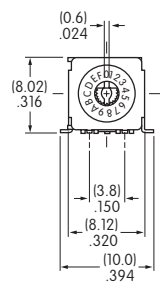

**ND3KR16H**

Terminal numbers are not on switch.

## PACKAGING

### **R** Tape-Reel Packaging for Upright & Right Angle

Switches must be ordered in 500-piece increments when tape-reel packaging is selected.

This packaging meets EIA-481-D Standard for "16mm and 24mm Embossed Carrier Taping of Surface Mount Components for Automatic Handling."

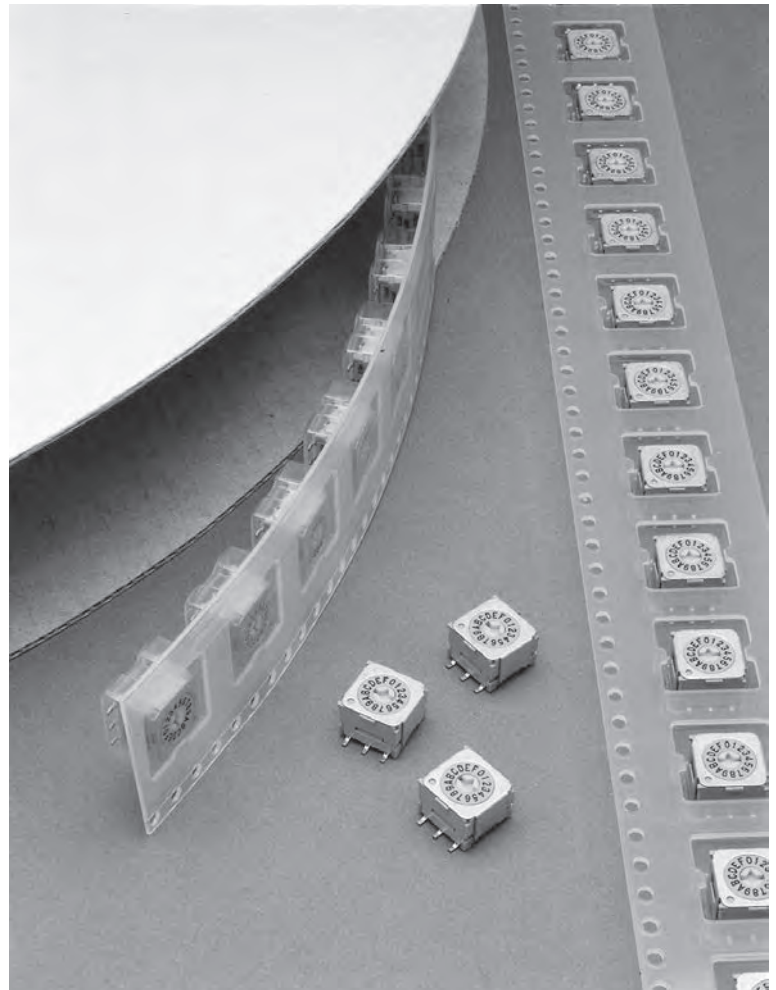

### **No Code** Partitioned Tray for Upright & Right Angle Any Quantity

If the ND3 is ordered in less than 500-piece increments, the switches are packaged in a partitioned tray. No code is required.



Toggle

Rockers

Pushbuttons

Illuminated PB

Programmable

Key locks

**G** Rotaries

Slides

Tactiles

Tilt

Touch

Indicators

Accessories

Supplement

## PACKAGING (CONTINUED)

### For Upright & Upright with Bracket (Codes P & B with F Actuator)

Each tape-reel of 550 pockets contains 500 switches  
 Minimum Leader Length: 9.05" (230mm) Minimum Trailer Length: 6.30" (160mm)

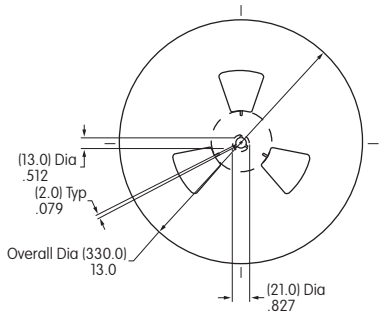

Reel Dimensions

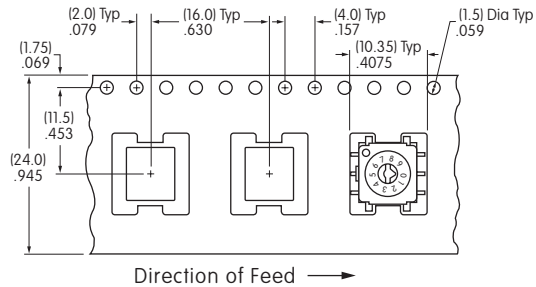
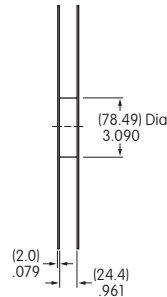

Tape Dimensions

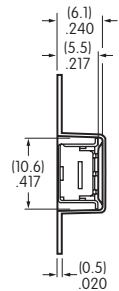

### For Upright & Upright with Bracket (Codes P & B with K Actuator)

Each tape-reel of 530 pockets contains 500 switches  
 Minimum Leader Length: 9.05" (230mm) Minimum Trailer Length: 6.30" (160mm)

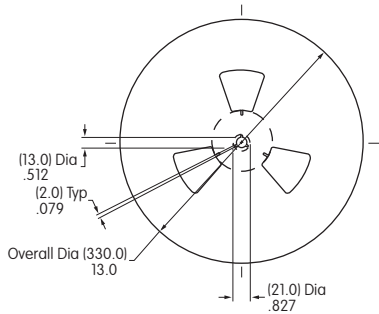

Reel Dimensions

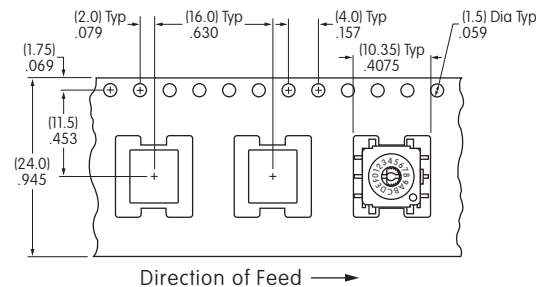
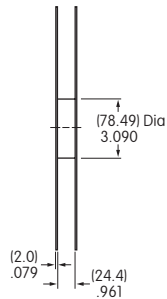

Tape Dimensions

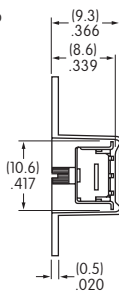

### For Right Angle (Code H with F or K Actuator)

Each tape-reel of 550 pockets contains 500 switches  
 Minimum Leader Length: 9.05" (230mm) Minimum Trailer Length: 6.30" (160mm)

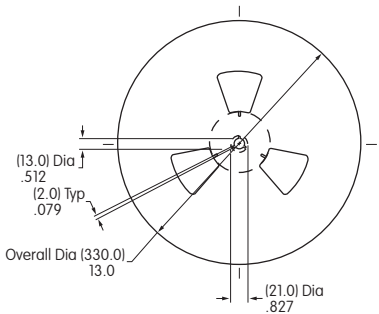

Reel Dimensions

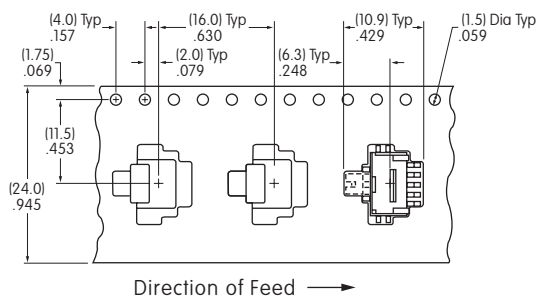
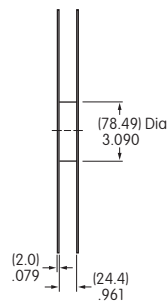

Tape Dimensions

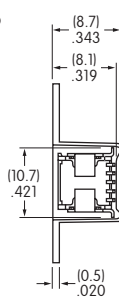



### GENERAL SPECIFICATIONS

#### Electrical Capacity

**Resistive Load:** HS13: 6A @ 125V AC, 3A @ 250V AC, or 5A @ 30V DC  
 HS16: 12A @ 125V AC or 6A @ 250V AC  
 TS: 6A @ 125/250V AC  
 PS: 30A @ 125/250V AC

#### Other Ratings

**Contact Resistance:** 10 milliohms maximum  
**Insulation Resistance:** 200 megohms minimum @ 500V DC  
**Dielectric Strength:** 1,500V AC minimum for 1 minute minimum  
**Mechanical Life:** HS: 15,000 operations minimum  
 TS: 30,000 operations minimum  
 PS: 10,000 operations minimum  
**Electrical Life:** HS: 7,500 operations minimum  
 TS: 10,000 operations minimum  
 PS: 5,000 operations minimum  
**Indexing:** 30° for HS16, TS & PS; 45° for HS13  
**Contact Timing:** Nonshorting HS13; Shorting & Nonshorting HS16; Nonshorting TS; Nonshorting PS  
**Range of Operating Torque:** HS16: 0.54 ~ 0.64Nm for first pole & 0.05Nm for each additional pole  
 HS13: 0.15 ~ 0.24Nm  
 TS: 0.09Nm for first pole & (0.07Nm x total number of poles) + 0.13Nm for additional poles  
 PS: 0.14Nm for each pole

#### Materials & Finishes

**Knob:** Phenolic resin  
**Shaft:** HS13: brass; HS16, TS, & PS: brass with nickel plating  
**Bushing:** HS13: brass; HS16, TS, & PS: brass with nickel plating  
**Case:** Phenolic resin  
**Movable Contacts:** HS13, HS16, & TS phosphor bronze; PS silver alloy  
**Stationary Contacts:** HS13, HS16, & PS: brass with silver plating; TS: phosphor bronze  
**Terminals:** HS: phosphor bronze; TS & PS: copper with silver plating

#### Environmental Data

**Operating Temp Range:** -10°C through +70°C (+14°F through +158°F)  
**Humidity:** 90 ~ 98% humidity for 96 hours @ 40°C (104°F)  
**Vibration:** 10 ~ 55 Hz with peak-to-peak amplitude of 1.5mm traversing the frequency range & returning in 1 minute; 3 right angled directions for 2 hours  
**Shock:** 50G (490m/s<sup>2</sup>) acceleration (tested in 3 right angled directions, with 3 shocks in each direction)

#### Installation

**Mounting Torque:** 2.94Nm (26 lb•in)  
**Maximum Panel Thickness:** Shown with panel cutouts in following drawings  
**Soldering Time & Temperature:** Manual Soldering (HS series only): See Profile A in Supplement section.

#### Standards & Certifications

**UL:** **File No. E44145 - Recognized only when ordered with marking on switch.**  
 Add "/U" or "/CUL" to end of part number to order UL recognized switch.  
 HS16 models 1- through 6-pole are recognized at 12A @ 125V AC & 6A @ 250V AC  
 See Supplement section to find UL or cULus rating details.

6 AMP SINGLE POLE/NONSHORTING/45° INDEXING

Round Shaft	D-flat Shaft	Number of Positions	Stopper Settings	Number of Terminals	Load Terminals	Schematics		
						HS13X	HS13Y	HS13Z
HS13X	HS13X-D	2	Fixed	1 COM, 2 LOAD	1 & 2			
HS13Y	HS13Y-D	3	Fixed	1 COM, 3 LOAD	1, 2, & 3			
HS13Z	HS13Z-D	4	Fixed	1 COM, 4 LOAD	1, 2, 3, & 4			

Switch is viewed from shaft end and shown in position 1. Terminal numbers are not on switch. Standard Hardware shown on last page of this section.

Keyway  
M10 P0.75  
(6.0) Dia .236  
(0.7) Typ .028  
(4.8) Typ .189  
(34.0) Dia 1.339  
(0.3) .012  
(5.7) Typ .224  
(16.0) .630  
(40.0) 1.575  
(2.6) Dia Typ .102  
45° Typ  
COM  
(10.5) Dia .413  
(9.0) .354  
(3.0) Dia .118  
(10.3) Dia .406  
(9.5) .374  
(1.5) .059

Maximum Effective Panel Thickness  
With Locking Ring  
.150" (3.8mm)  
Without Locking Ring  
.189" (4.8mm)

**HS13X**

12 AMP/SHORTING & NONSHORTING/30° INDEXING

Knurled Shaft		D-flat Shaft		Pole	Number of Positions	Stopper Settings	Number of Terminals	Schematic
Nonshorting	Shorting	Nonshorting	Shorting					
HS16-1	HS16-1S	HS16-1N	HS16-1SN	1P	2-11	2, 3, 4 . . . 11	1 COM, 11 LOAD	
HS16-2	HS16-2S	HS16-2N	HS16-2SN	2P	2-11	2, 3, 4 . . . 11	2 COM, 22 LOAD	
HS16-3	HS16-3S	HS16-3N	HS16-3SN	3P	2-11	2, 3, 4 . . . 11	3 COM, 33 LOAD	
HS16-4	HS16-4S	HS16-4N	HS16-4SN	4P	2-11	2, 3, 4 . . . 11	4 COM, 44 LOAD	
HS16-5	HS16-5S	HS16-5N	HS16-5SN	5P	2-11	2, 3, 4 . . . 11	5 COM, 55 LOAD	
HS16-6	HS16-6S	HS16-6N	HS16-6SN	6P	2-11	2, 3, 4 . . . 11	6 COM, 66 LOAD	

Switch is viewed from shaft end and shown in position 1. Terminal numbers are not on switch. Standard Hardware shown on last page of this section.

Keyway  
M10 P0.75  
(6.0) Dia .236  
(15.0) .591  
(14.0) .551  
(24.5) .965  
(34.5) 1.358  
(44.5) 1.752  
(54.5) 2.146  
(64.5) 2.539  
(74.5) 2.933  
(7.0) Max .276  
(0.84) Typ .033  
15°  
30°  
(65.0) 2.559  
(55.0) 2.165  
(4.4) .173  
(10.5) Dia .413  
(9.0) .354  
(3.0) Dia .118  
(10.3) Dia .406  
(9.5) .374  
(1.5) .059  
(8.0) Typ .315  
(6.24) Typ .246  
(2.6) Dia Typ .102

- On each deck of multipole devices common and load terminals are in the same positions as shown in the schematic above.
- Switch is viewed from the shaft end and shown in position 1.
- Terminal numbers are on the switch bottom. Stopper positions are molded on the top of the switch.
- Standard Hardware shown on last page of this section.

**HS16-2N**

Maximum Effective Panel Thickness  
With Locking Ring  
.189" (4.8mm)  
Without Locking Ring  
.228" (5.8mm)

### 6 AMP/ NONSHORTING/ ADJUSTABLE STOP/ 30° INDEXING

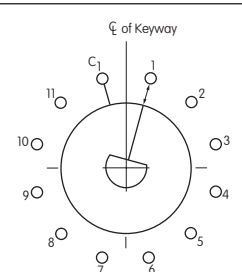
Model	Pole	Number of Positions	Stopper Settings	Number of Terminals	Shaft Type	Schematic
TS1N	1P	2-11	2, 3, 4 . . . 11	1 COM, 11 LOAD	D Flat	 <p>On each deck of multipole devices common &amp; load terminals are in the same positions as shown in this schematic.</p> <p>Switch is viewed from the shaft end and shown in position 1.</p> <p>Terminal numbers are on the switch bottom. Stopper positions are molded on the top of the switch.</p>
TS2N	2P	2-11	2, 3, 4 . . . 11	2 COM, 22 LOAD	D Flat	
TS3N	3P	2-11	2, 3, 4 . . . 11	3 COM, 33 LOAD	D Flat	
TS4N	4P	2-11	2, 3, 4 . . . 11	4 COM, 44 LOAD	D Flat	
TS5N	5P	2-11	2, 3, 4 . . . 11	5 COM, 55 LOAD	D Flat	

• Standard Hardware shown on last page of this section.

#### Panel Cutouts

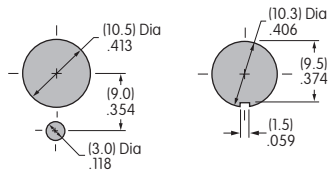

Maximum Effective Panel Thickness  
 With Locking Ring .189" (4.8mm)  
 Without Locking Ring .228" (5.8mm)

#### Top

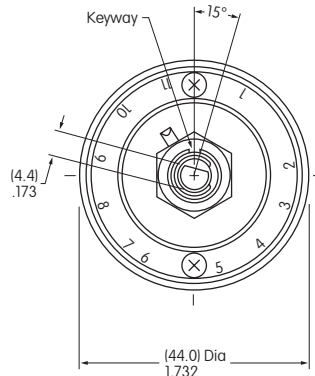

#### Bottom

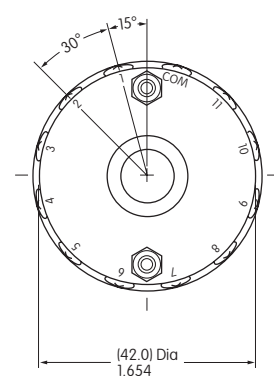

TS5N

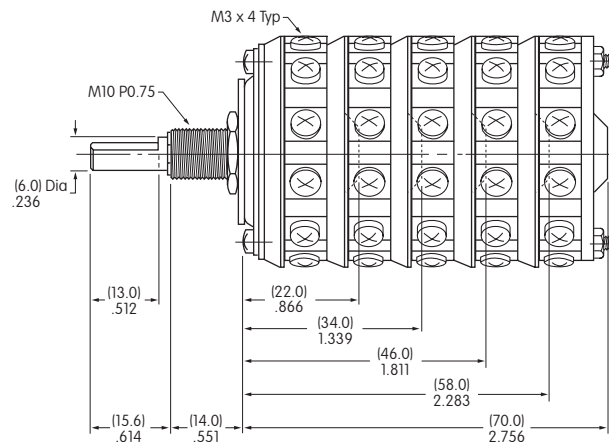

Toggles

Rockers

Pushbuttons

Illuminated PB

Keylocks

Rotaries

Slides

Tactiles

Tilt

Touch

Indicators

Accessories

Supplement



30 AMP/NONSHORTING/ADJUSTABLE STOP/30° INDEXING

Knurled Shaft	D Flat Shaft	Pole	Number of Positions	Stopper Settings	Number of Terminals	Schematic
PS1	PS1N	1P	2-11	2, 3, 4 . . . 11	1 COM, 11 LOAD	
PS2	PS2N	2P	2-11	2, 3, 4 . . . 11	2 COM, 22 LOAD	
PS3	PS3N	3P	2-11	2, 3, 4 . . . 11	3 COM, 33 LOAD	
PS4	PS4N	4P	2-11	2, 3, 4 . . . 11	4 COM, 44 LOAD	
PS5	PS5N	5P	2-11	2, 3, 4 . . . 11	5 COM, 55 LOAD	

On each deck of multipole devices common & load terminals are in the same positions as shown in this schematic. Switch is viewed from the shaft end and shown in position 1. Terminal numbers are on switch bottom. Stopper positions are molded on the top of the switch.

- Standard Hardware shown on last page of this section.

Panel Cutout

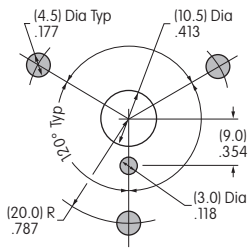

Maximum Effective Panel Thickness Without Locking Ring  
.189" (4.8mm)

Top

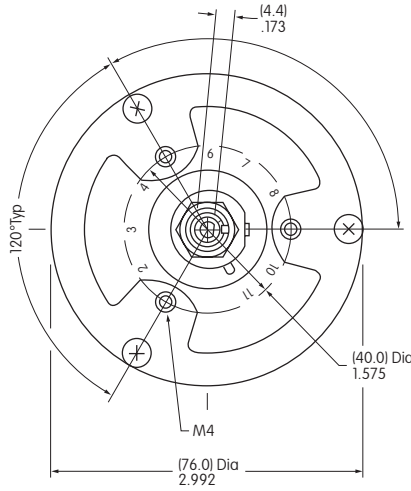

Bottom

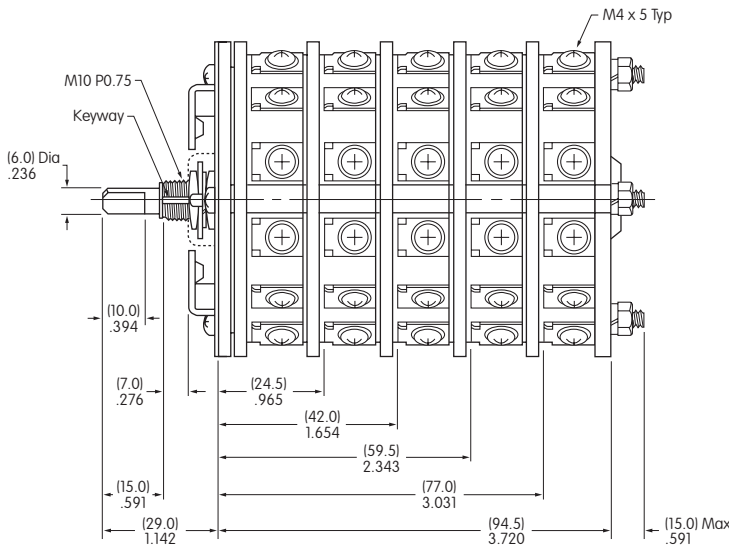
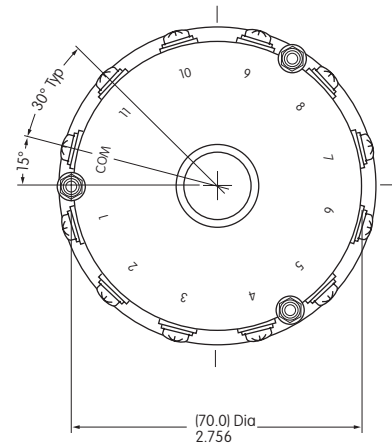

PS4N

### SHAFT TYPES

#### D Flat Shaft

For use with AT431 and AT432

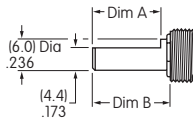

Dimension A	Dimension B
For TS (13.0) .512	For TS (15.6) .614
For HS (10.0) or PS .394	For HS (15.0) or PS .591

#### Knurled Shaft

Not for use with AT431 or AT432

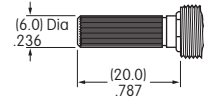

### OPTIONAL KNOBS FOR D FLAT SHAFTS

#### AT431 Large Knob

Phenolic Resin

Black only with white indicator line

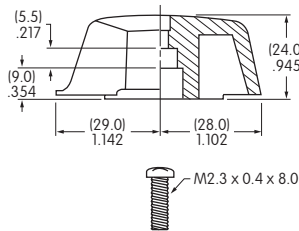
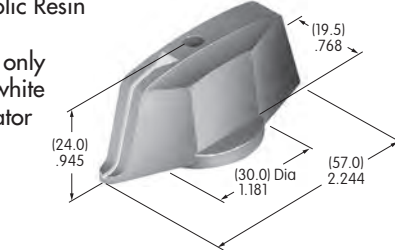

#### AT432 Small Knob

Phenolic Resin

Black only with white indicator line

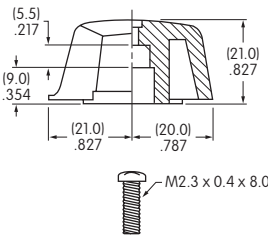
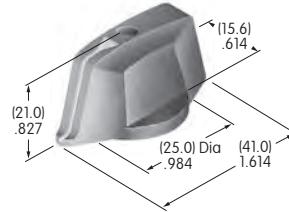

#### Knob Orientation

The rotary knobs used on the D-flat shafts can be oriented on the switch to suit the customer's particular front panel needs simply by sliding the knob over the square adaptor at the preferred orientation.

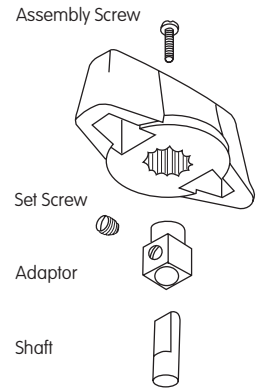

### STOPPER SETTING

#### For HS16, TS, & PS Models

The HS16, TS, and PS switches are supplied with the stopper plate set for the maximum number of positions allowed for that model. Prior to installation, the desired stopper setting should be made:

1. Be sure the shaft is turned counterclockwise to the extreme left. If the shaft is not turned counterclockwise to the extreme left, proper setting cannot be achieved.
2. Loosen the nut far enough to allow raising the stopper plate for resetting.
3. Insert the stopper in the numbered hole for the desired stopper setting. Satisfactory switch functioning cannot be assured if the stopper plate is not properly positioned.
4. Tighten the nut firmly against the stopper plate.

#### Standard Hardware Supplied with HS, TS, and PS:

- AT526 Hex Mounting Nut (quantity 3)
- AT518 Locking Ring (quantity 1)
- AT520 Split Lockwasher (quantity 1)
- Use of mounting supports on PS is optional; screws are not provided.

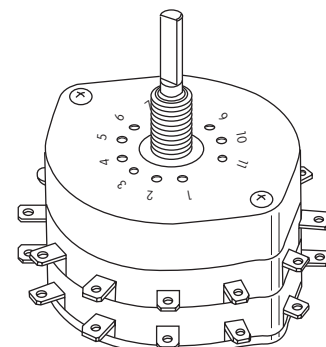

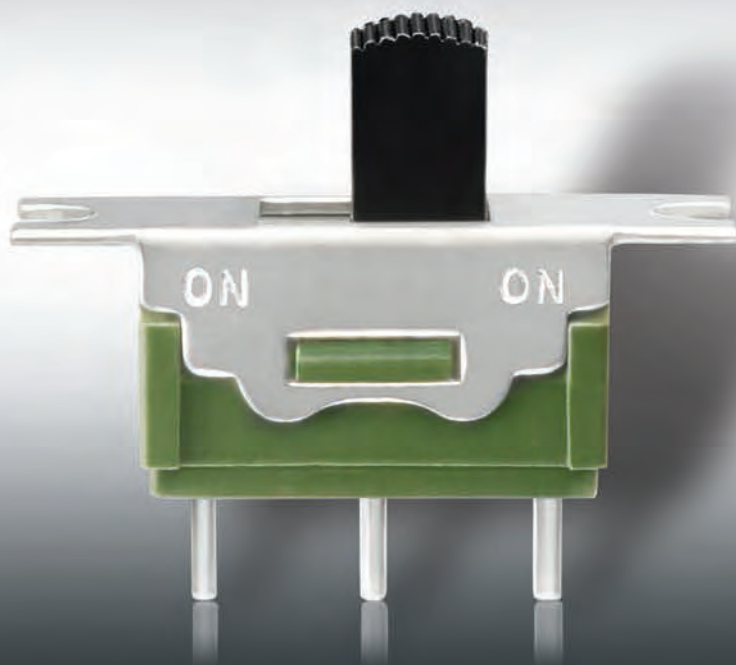

Toggles

Rockers

Pushbuttons

Programmable Illuminated PB

Keylocks

Rotaries

Slides **H**

Tactiles

Tilt

Touch

Indicators

Accessories

Supplement



## AS Series ..... H4

0.4VA Logic Level  
Straight, Right Angle & Vertical PC



## CS Series ..... H10

3A Power Level  
Straight PC  
PCB Mount



## FS Series ..... H14

High Frequency  
90MHz to 1GHz  
Straight PC



## JS01, JS03 Series ..... H18

Extended & Piano Actuated DIP Slides  
25mA @ 24V DC  
Straight PC



## JS02, JS04 SMT Series ..... H24

Ultra-miniature 25mA DIP Slide  
Gull Wing Terminals  
4- & 8-position



**MS Series** ..... H30

6A Power Level & 0.4VA Logic Level  
 Solder Lug, Straight PC, Right Angle & Vertical PC  
 Panel Mount, PCB Mount, & Bracket Mount



**MS Illuminated Series** ..... H38

6A Power Level  
 LED Illumination  
 Solder Lug & Straight PC  
 PCB Mount & Flat Frame Mount



**SM Series** ..... H42

Ultra-miniature  
 500mA or 1.0mA  
 Straight PC



**SS Series** ..... H44

0.1A Power Level & 0.4VA Logic Level  
 Top & Side Actuated  
 PCB Mount



**SS Illuminated Series** ..... H49

0.1A Power Level  
 LED Illumination  
 Top & Side Actuation  
 PCB Mount



**SS3 SMT Series** ..... H53

Ultra-miniature 0.4VA Logic Level  
 Side Actuated

Toggle

Rockers

Pushbuttons

Illuminated PB

Programmable

Keylocks

Rotaries

**H**  
Slides

Tactiles

Tilt

Touch

Indicators

Accessories

Supplement

# General Specifications

## Electrical Capacity (Resistive Load)

**Logic Level:** 0.4VA maximum @ 28V AC/DC maximum  
(Applicable Range 0.1mA ~ 0.1A @ 20mV ~ 28V)  
Note: Find additional explanation of operating range in Supplement section.

## Other Ratings

**Contact Resistance:** 50 milliohms maximum  
**Insulation Resistance:** 500 megohms minimum @ 500V DC  
**Dielectric Strength:** 500V AC minimum for 1 minute minimum  
**Mechanical Life:** 50,000 operations minimum  
**Electrical Life:** 50,000 operations minimum  
**Nominal Operating Force:** 2.55N  
**Contact Timing:** Nonshorting (break-before-make)  
**Travel:** Pretravel: .082" (2.1mm); Overtravel: .016" (0.4mm); Total Travel: .098" (2.5mm)

## Materials & Finishes

**Actuator:** Glass fiber reinforced polyamide  
**Upper Case Housing:** Carbon blended polyacetal (antistatic)  
**Lower Case Housing:** Glass fiber reinforced polyamide  
**Support Bracket:** Tin plated phosphor bronze  
**Movable Contact:** Phosphor bronze with gold plating  
**Stationary Contacts:** Brass with gold plating  
**Terminals:** Brass with gold plating

## Environmental Data

**Operating Temperature Range:** -30°C through +85°C (-22°F through +185°F)  
**Humidity:** 90 ~ 95% humidity for 192 hours @ 40°C (104°F)  
**Vibration:** 10 ~ 60Hz with peak-to-peak amplitude of 1.5mm traversing the frequency range & returning in 5 minutes; 3 right angled directions for 30 minutes  
**Shock:** 50G (490m/s<sup>2</sup>) acceleration (tested in 6 right angled directions, with 5 shocks in each direction)

## PCB Processing

**Soldering:** Wave Soldering Recommended. See Profile A in Supplement section.  
Manual Soldering: for single pole see Profile B in Supplement section; for double pole see Profile A.  
**Cleaning:** These devices are not process sealed. Hand clean locally using alcohol based solution.

## Standards & Certifications

The A Series slides have not been tested for UL recognition or CSA certification. These switches are designed for use in a low-voltage, low-current, logic-level circuit. When used as intended in a logic-level circuit, the results do not produce hazardous energy.

# Distinctive Characteristics

Subminiature size (1/3 size of Series M switches) saves space on PC boards.

Specifically developed for logic-level applications.

Award-winning STC contact mechanism with benefits unavailable in conventional mechanisms: smoother, positive detent actuation, increased contact stability and unparalleled logic-level reliability. (Additional STC details in Terms & Acronyms; see Supplement section.)

Available in various actuator lengths.

Antistatic superstructure of carbon blended polyacetal prevents static discharge to the contacts.

Molded-in, epoxy sealed or ultrasonically welded terminals lock out flux, solvents, and other contaminants.

.100" x .100" (2.54mm x 2.54mm) terminal spacing conforms to standard PC board grid spacing.

Matching indicators available.

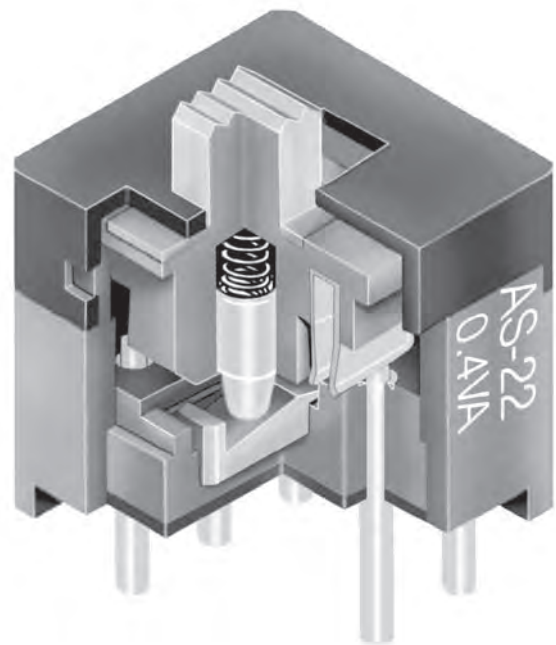

Actual Size

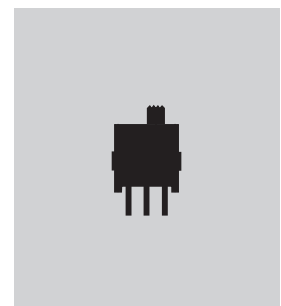

## TYPICAL SWITCH ORDERING EXAMPLE

**AS**      **2**      **2**      **A**      **H**

Poles		Circuits				Actuators		PC Terminals	
1	SPST SPDT	1	ON	NONE	OFF	A	.098" (2.5mm) Long	P	Straight
2	DPDT SP3T	2	ON	NONE	ON	B	Flush	*B	Straight with Bracket
		3	ON	OFF	ON	C	.150" (3.8mm) Long	*H	Right Angle with Bracket
		4	ON	ON	ON			*V	Vertical with Bracket

\*Bracketed models are ESD protected

### DESCRIPTION FOR TYPICAL ORDERING EXAMPLE

**AS22AH**



DPDT  
ON-NONE-ON Circuit

.098" (2.5mm) Long  
Actuator



Right Angle PC Terminals

## POLES & CIRCUITS

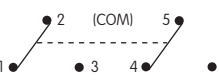
Pole	Model	Slide Position			Connected Terminals			Throw & Schematics
		Left	Center	Right	Left	Center	Right	
SP	AS11	ON	NONE	OFF	3-1	OPEN	OPEN	SPST 
SP	AS12 AS13	ON ON	NONE OFF	ON ON	2-1 2-1	OPEN OPEN	2-3 2-3	SPDT 
DP	AS22 AS23	ON ON	NONE OFF	ON ON	2-1 5-4 2-1 5-4	OPEN OPEN	2-3 5-6 2-3 5-6	DPDT 

Note: Terminal numbers are not actually on the switch.

### For 3 Throw (3-On)

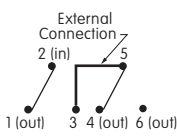
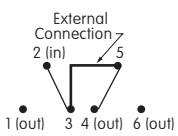
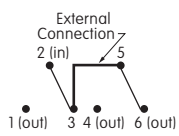
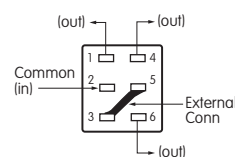
Pole	Model	Connected Terminals & Schematics			External Connection
		Left	Center	Right	
SP	AS24	ON  2-1 5-4	ON  2-3 5-4	ON  2-3 5-6	The SP3T model utilizes a double pole base.  External connections must be made during field installation. 



## ACTUATORS

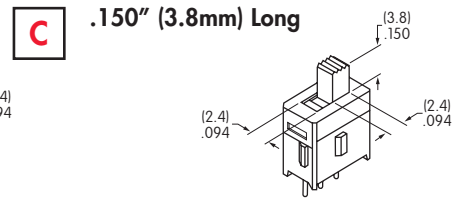
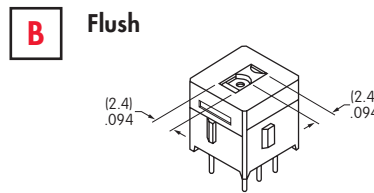
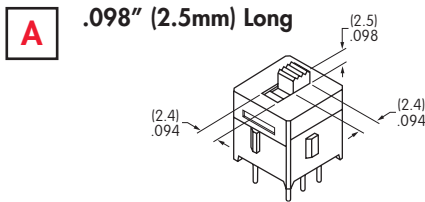

**Actuator Color:** Gray standard; contact factory for other colors.

## PC TERMINALS

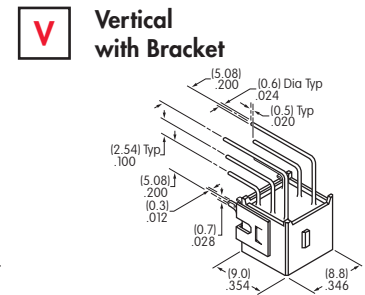
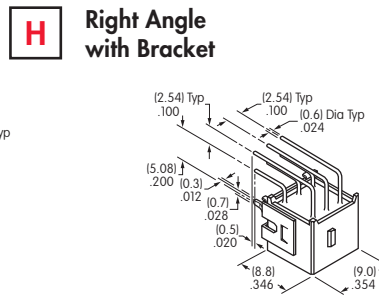
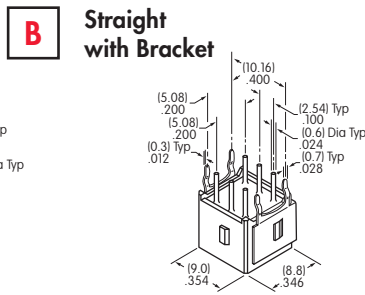
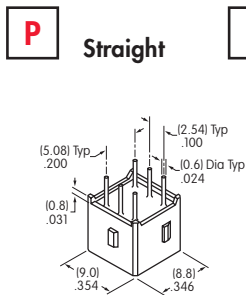

Use of a support bracket is recommended to increase PCB mounting strength and stability.

## TYPICAL SWITCH DIMENSIONS

### Single Pole

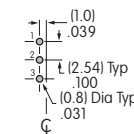
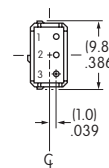
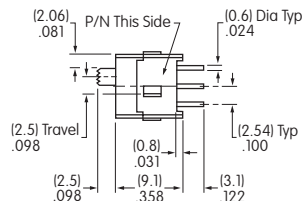
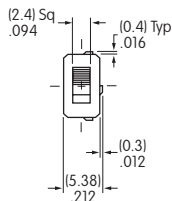

### Straight PC



Actuator shown in LEFT position

Single throw models do not have terminal 2.

**AS12AP**

### Double Pole

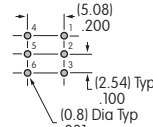
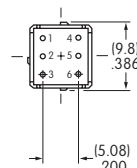
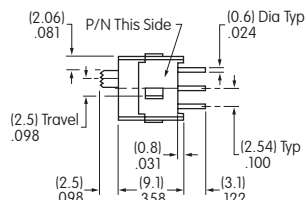
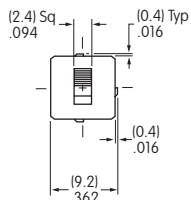

### Straight PC



Actuator shown in LEFT position

**AS22AP**

### Single Pole

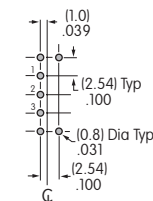
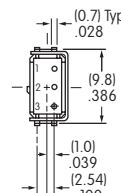
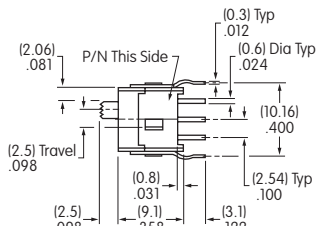
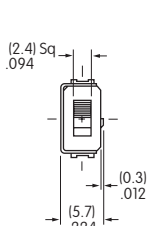

### Straight PC • Bracket



Actuator shown in LEFT position

**AS12AB**

## TYPICAL SWITCH DIMENSIONS

### Straight PC • Bracket

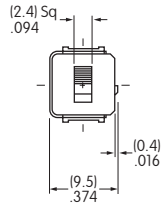

**AS22AB**

### Double Pole

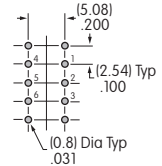
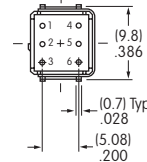
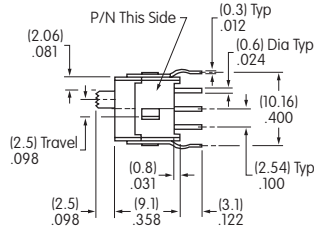

Actuator shown in LEFT position

### Right Angle PC

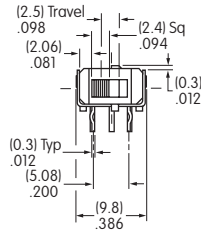

**AS12AH**

### Single Pole

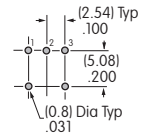
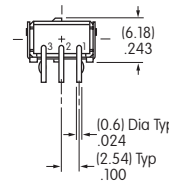
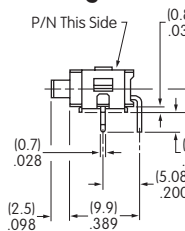

Actuator shown in LEFT position

### Right Angle PC

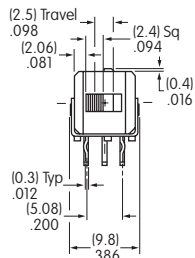

**AS22AH**

### Double Pole

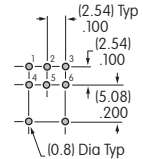
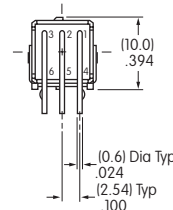
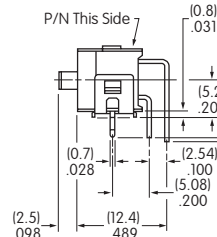

Actuator shown in LEFT position

### Vertical PC

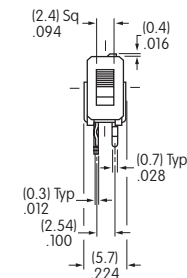

**AS12AV**

### Single Pole

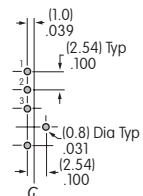
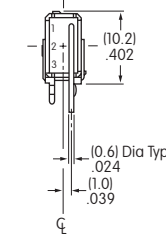
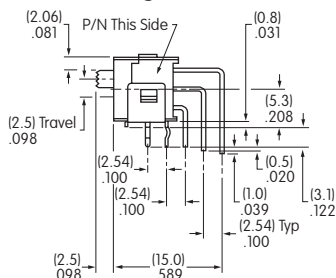

Actuator shown in LEFT position

### Vertical PC

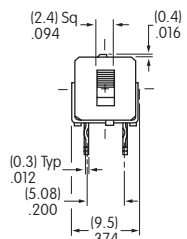

**AS22AV**

### Double Pole

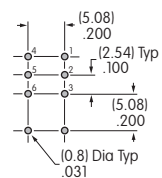
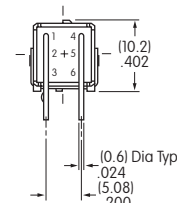
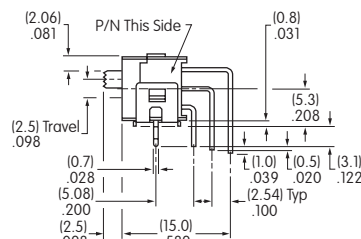

Actuator shown in LEFT position

Toggles  
Rockers  
Pushbuttons  
Illuminated PB  
Keylocks  
Rotaries  
Slides  
Tactiles  
Tilt  
Touch  
Indicators  
Accessories  
Supplement



# General Specifications

## Electrical Capacity (Resistive Load)

**Power Level:** 3A @ 125V AC or 2A @ 250V AC

## Other Ratings

**Contact Resistance:** 10 milliohms maximum

**Insulation Resistance:** 1,000 megohms minimum @ 500V DC

**Dielectric Strength:** 1,000V AC minimum between contacts for 1 minute minimum;  
1,500V AC minimum between contacts & case for 1 minute minimum

**Mechanical Life:** 50,000 operations minimum

**Electrical Life:** 20,000 operations minimum

**Static Capability:** Withstands 12 kilovolts ESD

**Contact Timing:** Nonshorting (break-before-make)

**Total Travel:** .087" (2.2mm)

## Materials & Finishes

**Actuator:** Glass fiber reinforced polyamide

**Cover & Case:** Glass fiber reinforced polyamide (UL94V-0)

**Movable Contacts:** Copper with silver plating

**Stationary Contacts:** Silver capped copper with silver plating

**Terminals:** Copper with silver plating

## Environmental Data

**Operating Temp Range:** -30°C through +85°C (-22°F through +185°F)

**Humidity:** 90 ~ 95% humidity for 240 hours @ 40°C (104°F)

**Vibration:** 10 ~ 55Hz with peak-to-peak amplitude of 1.5mm traversing the frequency range & returning in 1 minute; 3 right angled directions for 2 hours

**Shock:** 50G (490m/s<sup>2</sup>) acceleration (tested in 6 right angled directions, with 5 shocks in each direction)

## Installation

**Soldering Time & Temp:** Wave Soldering: See Profile A in Supplement section.

Manual Soldering: See Profile B in Supplement section.

**Cleaning:** These devices are not process sealed. Hand clean locally using alcohol based solution.

## Standards & Certifications

**Flammability Standard:** UL94V-0 cover & case

# Distinctive Characteristics

High performance and high quality at a low price.

Molded cover and case of high insulating material withstand 12 kilovolts of electrostatic discharge (ESD), providing antistatic feature.

Cover and case UL 94V-0 flammability rated.

Epoxy sealed terminals to lock out flux, dust, and other contaminants.

Suited for a wide variety of applications including telecommunications, electronic controls, audio devices, and household appliances.

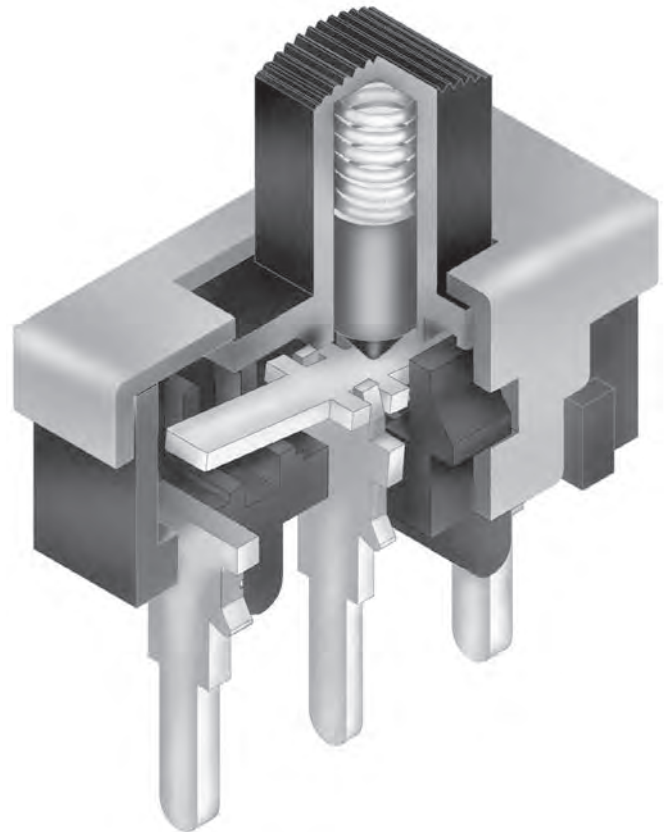

Actual Size

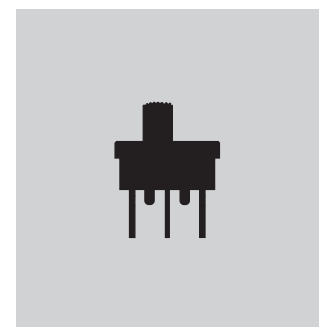

- Supplement
- Accessories
- Indicators
- Touch
- Tilt
- Tactiles
- H Slides**
- Rotaries
- Key locks
- Programmable
- Illuminated PB
- Pushbuttons
- Rockers
- Toggle

### TYPICAL SWITCH ORDERING EXAMPLE

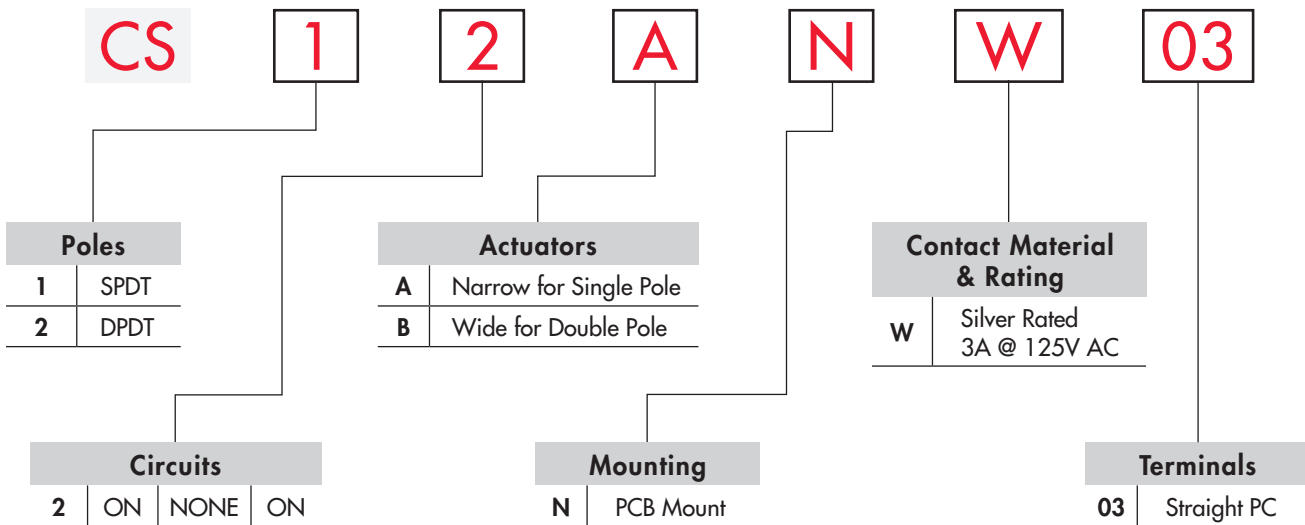

### DESCRIPTION FOR TYPICAL ORDERING EXAMPLE

**CS12ANW03**

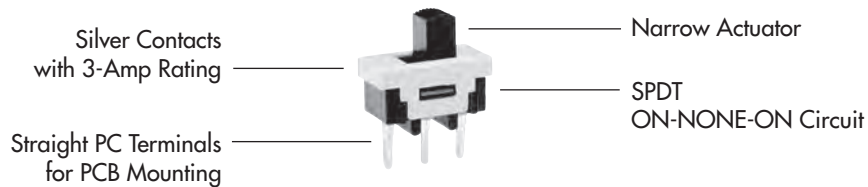

### POLES & CIRCUITS

Pole	Model	Slide Position			Connected Terminals			Throw & Schematics
		Left	Center	Right	Left	Center	Right	
SP	CS12	ON	NONE	ON	2-1	OPEN	2-3	SPDT 
DP	CS22	ON	NONE	ON	2-1 5-4	OPEN	2-3 5-6	DPDT 

Note: Terminal numbers are not actually on switch.

MOUNTING

Panel Cutouts

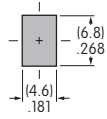

Single Pole

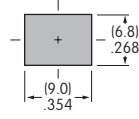

Double Pole

PCB Footprints

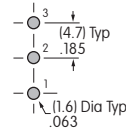

Single Pole

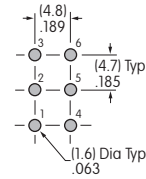

Double Pole

TYPICAL SWITCH DIMENSIONS

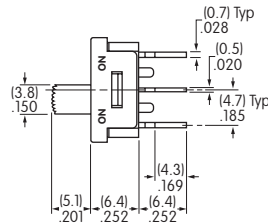
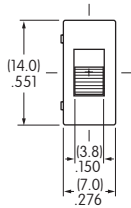

Actuator shown in LEFT position

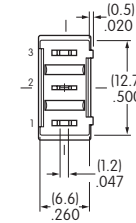

Single Pole



CS12ANW03

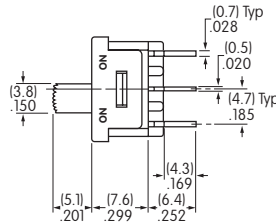
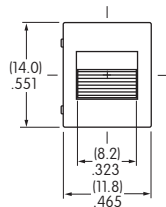

Actuator shown in LEFT position

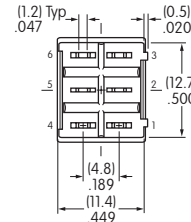

Double Pole



CS22BNW03

# General Specifications

For high frequency (DC through 1GHz): Isolation 40dB minimum at 1GHz.  
Insertion loss 0.5dB maximum at 1GHz.

Impedance 75 ohms

Innovative alternative to relay products

Highly reliable, self-cleaning twin contact mechanism with gold plating

Long total travel of .138" (3.5mm) for highly visible actuator position

Distinct audible and tactile feedback during actuation

Suited to high frequency applications (90MHz to 1GHz) such as CATV and communication equipment

Actual Size  
with Tall Actuator

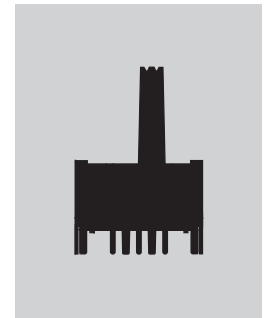

# Distinctive Characteristics

## Electrical Capacity (Resistive Load)

**Logic Level:** 0.4VA maximum @ 28V AC/DC maximum  
(Applicable Range 0.1mA ~ 0.1A @ 20mV ~ 28V)  
Note: Find additional explanation of operating range in Supplement section.

## RF Ratings

**Impedance:** 75 ohms  
**Insertion Loss:** 0.5dB maximum @ 1GHz  
**Isolation:** 40dB minimum @ 1GHz

## Other Ratings

**Contact Resistance:** 200 milliohms maximum  
**Insulation Resistance:** 250 megohms minimum @ 500V DC  
**Dielectric Strength:** 500V AC minimum for 1 minute minimum  
**Mechanical Life:** 1,000 operations minimum  
**Electrical Life:** 1,000 operations minimum  
**Contact Timing:** Nonshorting (break-before-make)  
**Total Travel:** .138" (3.5mm)

## Environmental Data

**Operating Temp Range:** -30°C through +85°C (-22°F through +185°F)  
**Humidity:** 90 ~ 95% humidity for 240 hours @ 40°C (104°F)  
**Vibration:** 10 ~ 55Hz with peak-to-peak amplitude of 1.5mm traversing the frequency range & returning in 5 minutes; 3 right angled directions for 2 hours  
**Shock:** 50G (490m/s<sup>2</sup>) acceleration (tested in 6 right angled directions, with 5 shocks in each direction)

## Installation

**Soldering Time & Temp:** Wave Soldering: See Profile A in Supplement section.  
Manual Soldering: See Profile A in Supplement section.  
**Cleaning:** These devices are not process sealed. Hand clean locally using alcohol based solution.



TYPICAL SWITCH ORDERING EXAMPLE

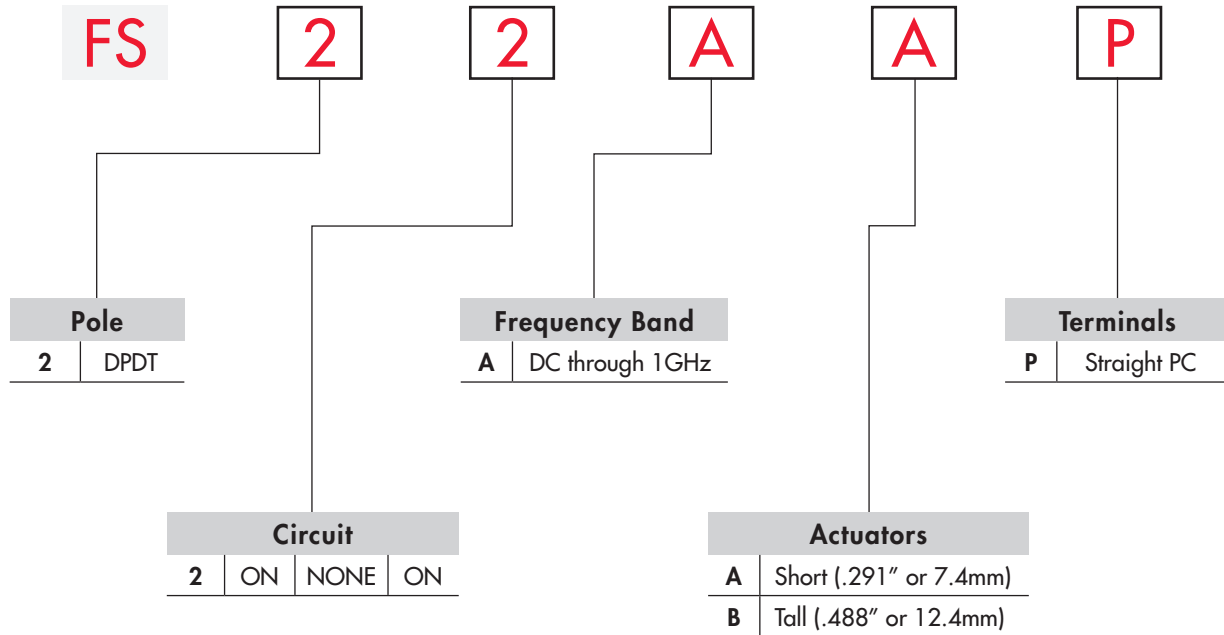

DESCRIPTION FOR TYPICAL ORDERING EXAMPLE

**FS22AAP**

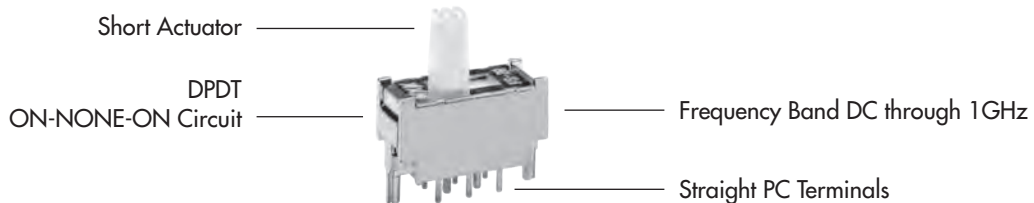

POLE & CIRCUIT

		Slide Position			Connected Terminals			Throw & Schematics
Pole	Model	Left	Center	Right	Left	Center	Right	
DP	<b>FS22</b>	ON	NONE	ON	2-1 5-4	NA	2-3 5-6	Note: Terminal numbers are not actually on the switch. 

## HIGH FREQUENCY PERFORMANCE

### RF Connection Options

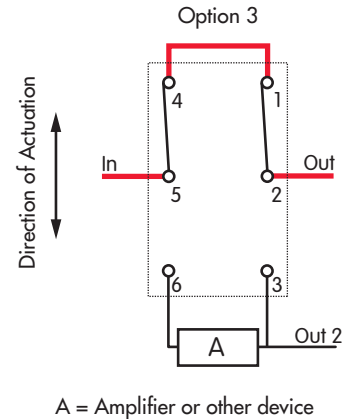
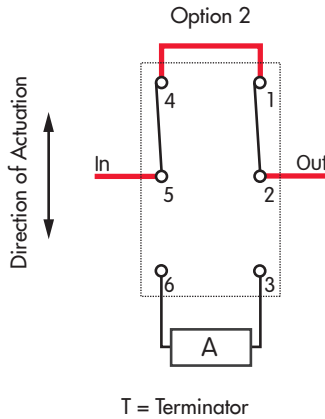
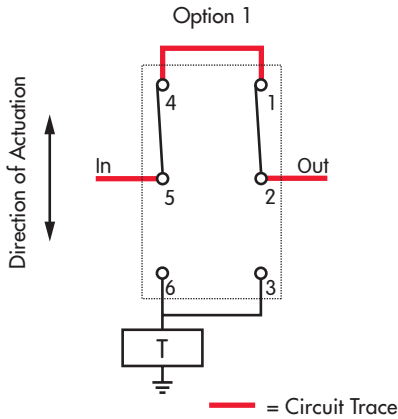

— = Circuit Trace

T = Terminator

A = Amplifier or other device

### Isolation

>40dB @ 1GHz  
(higher value is better)

### Insertion Loss

<0.5dB @ 1GHz  
(lower value is better)

### Standing Wave Ratio or Impedance Matching

Standing Wave = ratio between highest voltage & lowest voltage  
(must always be more than 1)

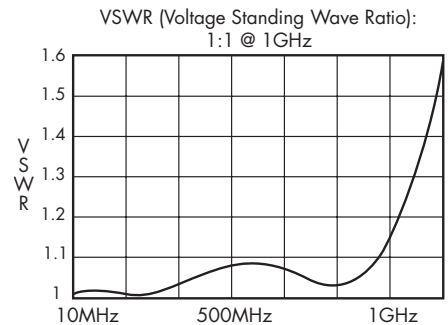
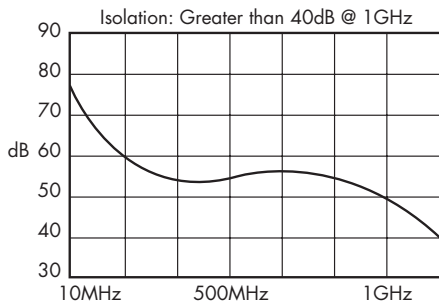

Note: The data above reflects the conditions using the FS switch on a test PCB with two coaxial connectors. High frequency applications require external connection on the PCB. Contact factory for details.

## TYPICAL SWITCH DIMENSIONS

### Short & Tall Actuators

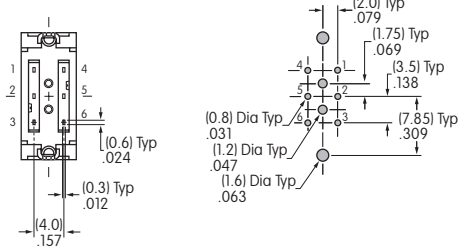
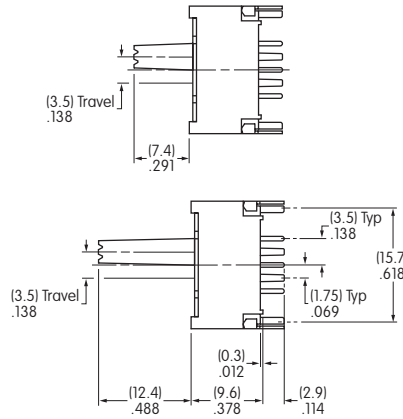
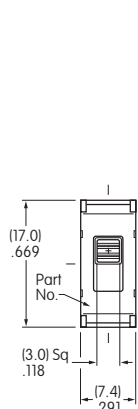

Actuator in LEFT position.

FS22ABP

Toggles  
Rockers  
Pushbuttons  
Illuminated PB  
Programmable  
Keylocks  
Rotaries  
Slides  
Tactiles  
Tilt  
Touch  
Indicators  
Accessories  
Supplement



# General Specifications

### Electrical Capacity (Resistive Load)

**Switching Rating:** 25mA @ 24V DC  
**Nonswitching Rating:** 0.1A @ 50V DC

### Other Ratings

**Contact Resistance:** 50 milliohms maximum  
**Insulation Resistance:** 100 megohms minimum @ 500V DC  
**Dielectric Strength:** 500V AC minimum for 1 minute minimum  
**Mechanical Life:** 2,000 operations minimum  
**Electrical Life:** 2,000 operations minimum  
**Total Travel:** For slide actuator: .031" (0.8mm); for piano actuator: .114" (2.9mm)

### Materials & Finishes

	JS01 Slide DIP	JS03 Piano DIP
<b>Actuator:</b>	Glass fiber reinforced polyamide	Glass fiber reinforced PBT
<b>Cover:</b>	Glass fiber reinforced polyamide (UL94V-0)	Glass fiber reinforced PBT (UL94V-0)
<b>Base:</b>	Glass fiber reinforced polyamide (UL94V-0)	Glass fiber reinforced PBT (UL94V-0)
<b>Contacts:</b>	Beryllium copper with gold plating	Phosphor bronze with gold plating
<b>Terminals:</b>	Brass with gold plating	Phosphor bronze with gold plating

### Environmental Data

**Operating Temp Range:** -25°C through +70°C (-13°F through +158°F)  
**Humidity:** 90 ~ 95% humidity for 96 hours @ 40°C (104°F)  
**Vibration:** 10 ~ 55Hz with peak-to-peak amplitude of 1.5mm traversing the frequency range & returning in 1 minute; 3 right angled directions for 2 hours  
**Shock:** 50G (490m/s<sup>2</sup>) acceleration (tested in 6 right angled directions, with 5 shocks in each direction)

### PCB Processing

**Soldering:** Wave Soldering Recommended. See Profile A in Supplement section.  
 Manual Soldering: See Profile A in Supplement section.  
 Note: Switches are packaged in OFF position and should be soldered in OFF position.  
**Cleaning:** These devices are not process sealed. Hand clean locally using alcohol based solution.

### Standards & Certifications

**Flammability Standards:** UL 94V-0 rated cover & base  
 The JS series devices have not been tested for UL recognition and CSA certification. These switches are designed for use in a low-voltage, low-current circuit. When used as intended in a low-voltage, low-current circuit, the results do not produce hazardous energy.

Toggle

Rockers

Pushbuttons

Illuminated PB

Programmable

Keylocks

Rotaries

Slides

Tactiles

Tilt

Touch

Indicators

Accessories

Supplement

# Distinctive Characteristics

Slide type and piano type actuators available.

Twin sliding contact mechanism with self-cleaning action (JS01) provides smooth actuation and produces high contact reliability.

Gold plated contacts prevent oxidation and sulfide effect and provide stable contact resistance.

Use of self-extinguishing UL94V-0 certified material in cover and base provides high arc resistance and high insulation resistance.

Slanted terminals ensure secure PCB mounting and prevent dislodging during wave soldering.

Terminal spacing conforms to standard .100" (2.54mm) PCB grid.

End-to-end stackable.

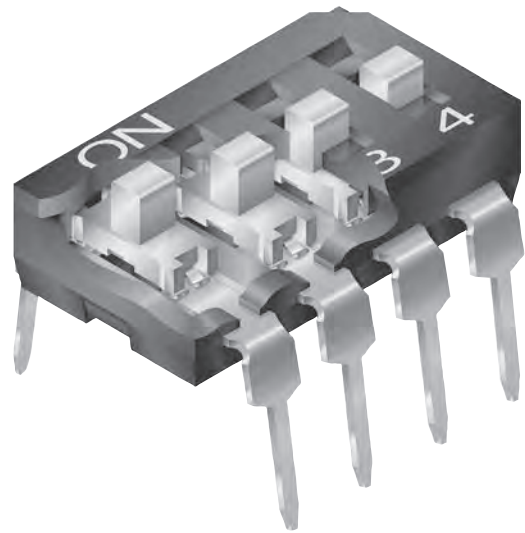

Actual Sizes

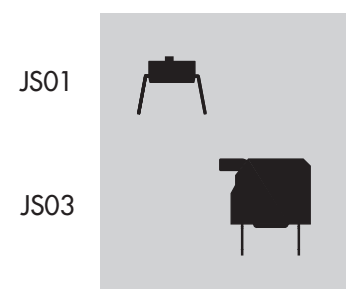

### TYPICAL SWITCH ORDERING EXAMPLE

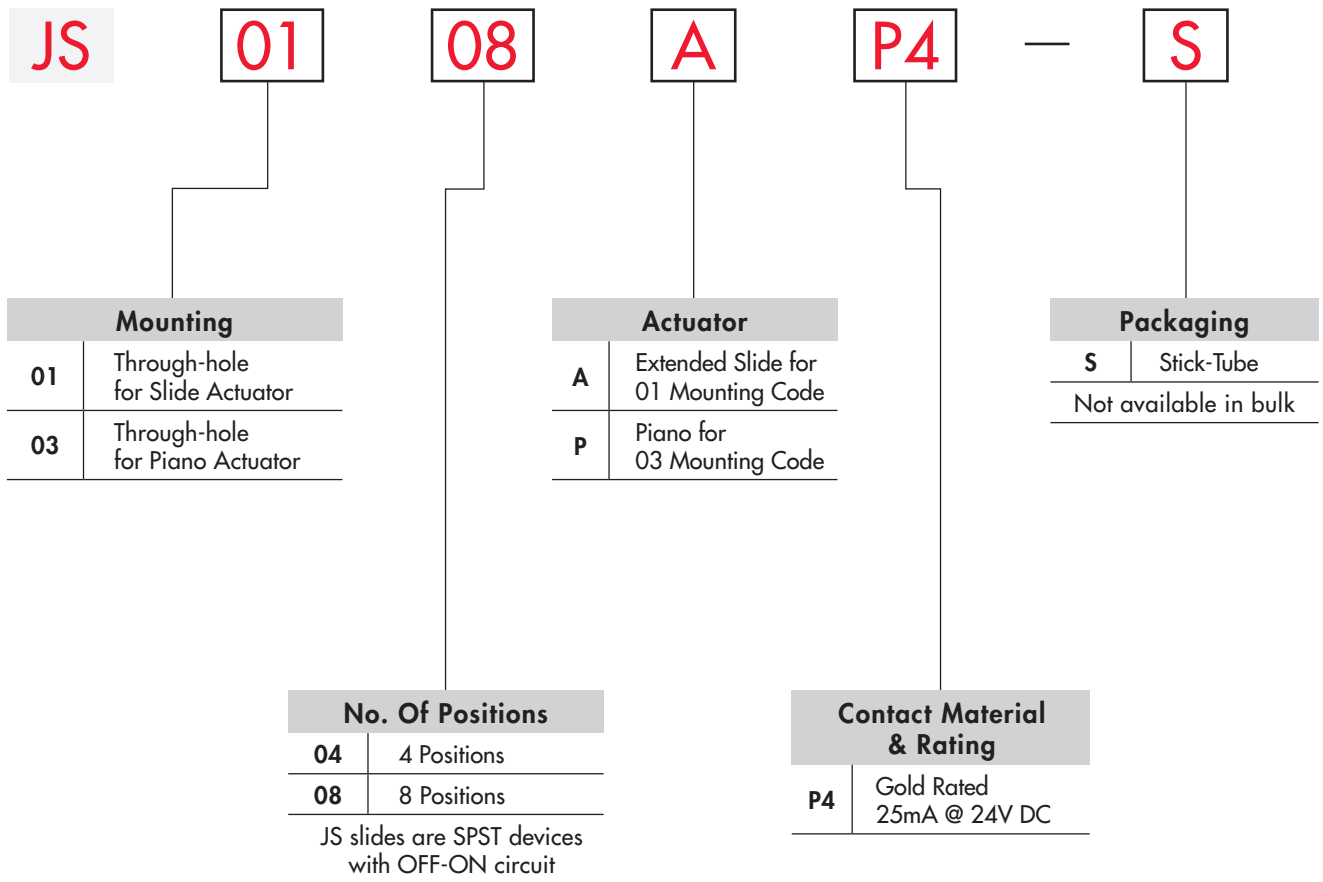

### DESCRIPTION FOR TYPICAL ORDERING EXAMPLE

**JS0108AP4-S**

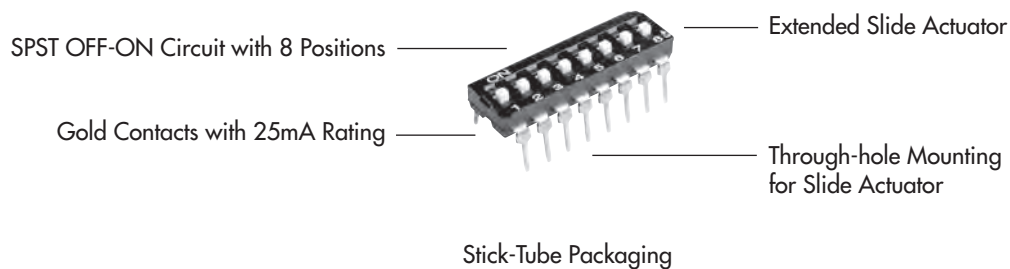

TYPICAL SWITCH DIMENSIONS

Slide Actuator

4 Positions

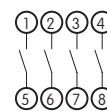
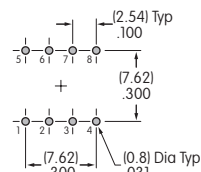
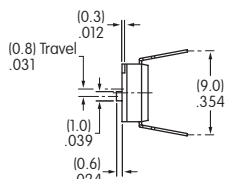
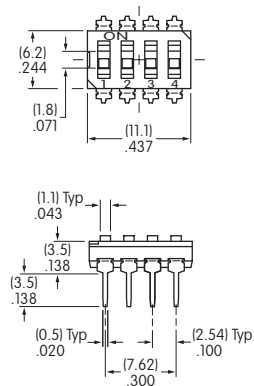

End View

Schematic

JS0104AP4

Slide Actuator

8 Positions

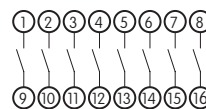
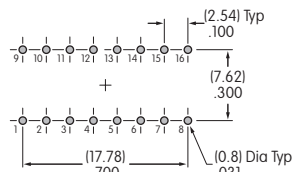
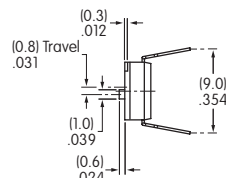
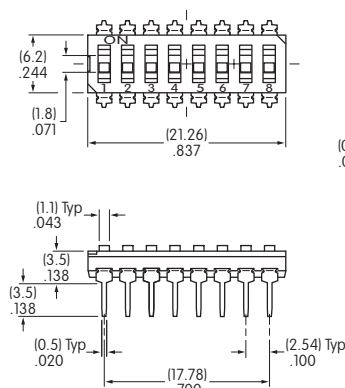

End View

Schematic

JS0108AP4

Piano Actuator

4 Positions

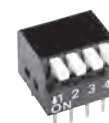
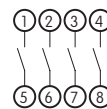
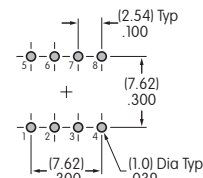
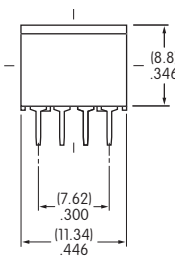
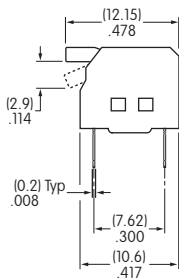
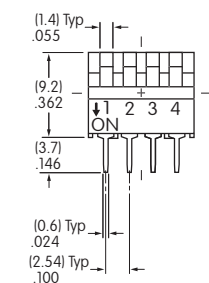

Schematic

JS0304PP4

Piano Actuator

8 Positions

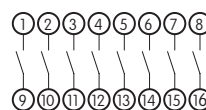
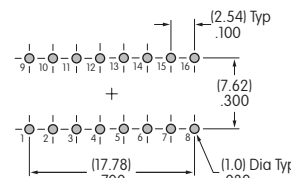
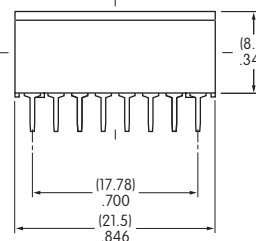
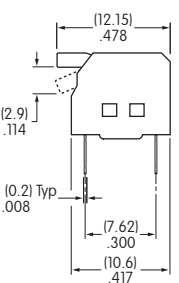
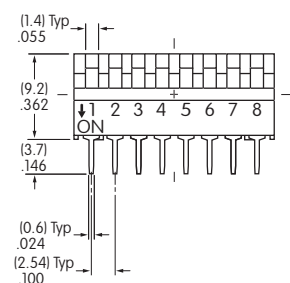

Schematic

JS0308PP4

### PACKAGING

**S**

#### Stick-Tube Packaging

Switches are not available in bulk and must be ordered in increments of:

##### Slide Actuator

JS0104AP4-S: 46 pieces per stick-tube

JS0108AP4-S: 24 pieces per stick-tube

##### Piano Actuator

JS0304PP4-S: 44 pieces per stick-tube

JS0308PP4-S: 23 pieces per stick-tube

Switches are packaged in OFF position.

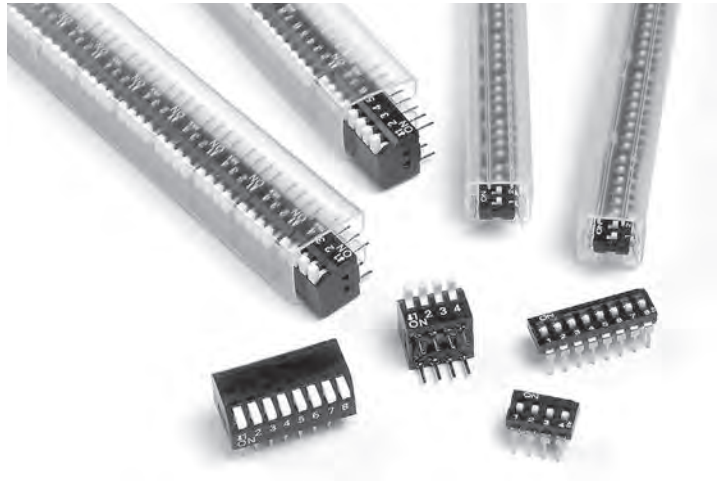

**Stick-Tube Dimensions for Slide Actuator  
JS0104AP4-S & JS0108AP4-S**

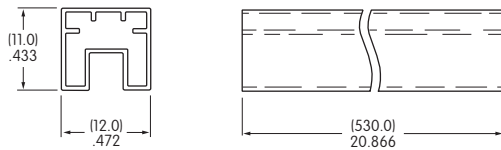

**Stick-Tube Dimensions for Piano Actuator  
JS0304PP4-S & JS0308PP4-S**

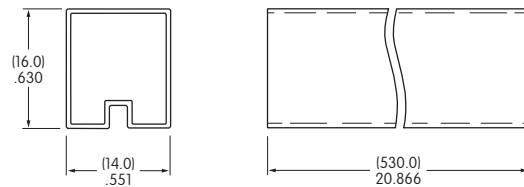

Toggles

Rockers

Pushbuttons

Illuminated PB

Programmable

Keylocks

Rotaries

Slides

Tactiles

Tilt

Touch

Indicators

Accessories

Supplement





# General Specifications

Toggles  
Rocker  
Pushbuttons  
Illuminated PB  
Programmable  
Keylocks  
Rotaries  
Slides  
Tactiles  
Tilt  
Touch  
Indicators  
Accessories  
Supplement

### Electrical Capacity (Resistive Load)

**Switching Rating:** 25mA @ 24V DC  
**Nonswitching Rating:** 0.1A @ 50V DC

### Other Ratings

	JS02 Extended Actuator	JS04 Flush Actuator
<b>Contact Resistance:</b>	50 milliohms maximum	50 milliohms maximum
<b>Insulation Resistance:</b>	100 megohms minimum @ 500V DC	100 megohms minimum @ 100V DC
<b>Dielectric Strength:</b>	500V AC minimum for 1 minute minimum	300V AC minimum for 1 minute minimum
<b>Mechanical Life:</b>	2,000 operations minimum	2,000 operations minimum
<b>Electrical Life:</b>	2,000 operations minimum	2,000 operations minimum
<b>Total Travel:</b>	.031" (0.8mm)	.026" (0.65mm)

### Materials & Finishes

	JS02 Extended Actuator	JS04 Flush Actuator
<b>Actuator:</b>	Glass fiber reinforced polyamide	Glass fiber reinforced polyamide
<b>Cover:</b>	Glass fiber reinforced polyamide (UL94V-0)	Glass fiber reinforced polyamide (UL94V-0)
<b>Base:</b>	Glass fiber reinforced polyamide (UL94V-0)	Glass fiber reinforced polyamide (UL94V-0)
<b>Contacts:</b>	Beryllium copper with gold plating	Copper alloy with gold plating
<b>Terminals:</b>	Brass with gold plating	Brass with gold plating

### Environmental Data

**Operating Temp Range:** **JS02 Extended Actuator:** -20°C through +70°C (-4°F through +158°F)  
**JS04 Flush Actuator:** -30°C through +85°C (-22°F through +185°F)

**Humidity:** 90 ~ 95% humidity for 96 hours @ 40°C (104°F)

**Vibration:** 10 ~ 55Hz with peak-to-peak amplitude of 1.5mm traversing the frequency range & returning in 1 minute; 3 right angled directions for 2 hours

**Shock:** 50G (490m/s<sup>2</sup>) acceleration (tested in 6 right angled directions, with 5 shocks in each direction)

### PCB Processing

**Soldering:** Reflow Soldering Recommended. See Profile A in Supplement section.  
Manual Soldering: See Profile A in Supplement section.  
Note: Switches are packaged in OFF position and should be soldered in OFF position.

**Cleaning:** These devices are not process sealed. Hand clean locally using alcohol based solution.

### Standards & Certifications

**Flammability Standards:** UL 94V-0 rated cover & base  
The JS Series slides have not been tested for UL recognition or CSA certification. These switches are designed for use in a low-voltage, low-current circuit. When used as intended in a low-voltage, low-current circuit, the results do not produce hazardous energy.

# Distinctive Characteristics

Extended and flush slide actuators available.

Twin sliding contact mechanism with self-cleaning action (JS02) provides smooth actuation and produces high contact reliability.

Gold plated contacts prevent oxidation and sulfide effect and provide stable contact resistance.

Use of self-extinguishing UL94V-0 certified material in cover and base provides high arc resistance and high insulation resistance.

Gull-wing terminals ensure secure PCB mounting and prevent dislodging during vapor phase and infrared convection reflow soldering.

Terminal spacing conforms to standard PCB grid.  
For JS02: .100" (2.54mm)  
For JS04: .050" (1.27mm)

End-to-end stackable.

Packaged in tape-reel or stick-tube. Tape-reel packaging meets EIA-481-D Standard.

Coplanarity: all considered surfaces must lie between two parallel planes that are a maximum distance apart of .0059" (0.15mm). (Additional coplanarity details in Terms and Acronyms in the Supplement section.)

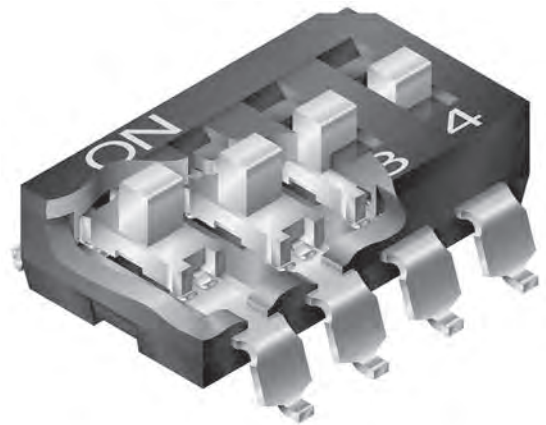

Actual Sizes

JS02



JS04



### TYPICAL SWITCH ORDERING EXAMPLE

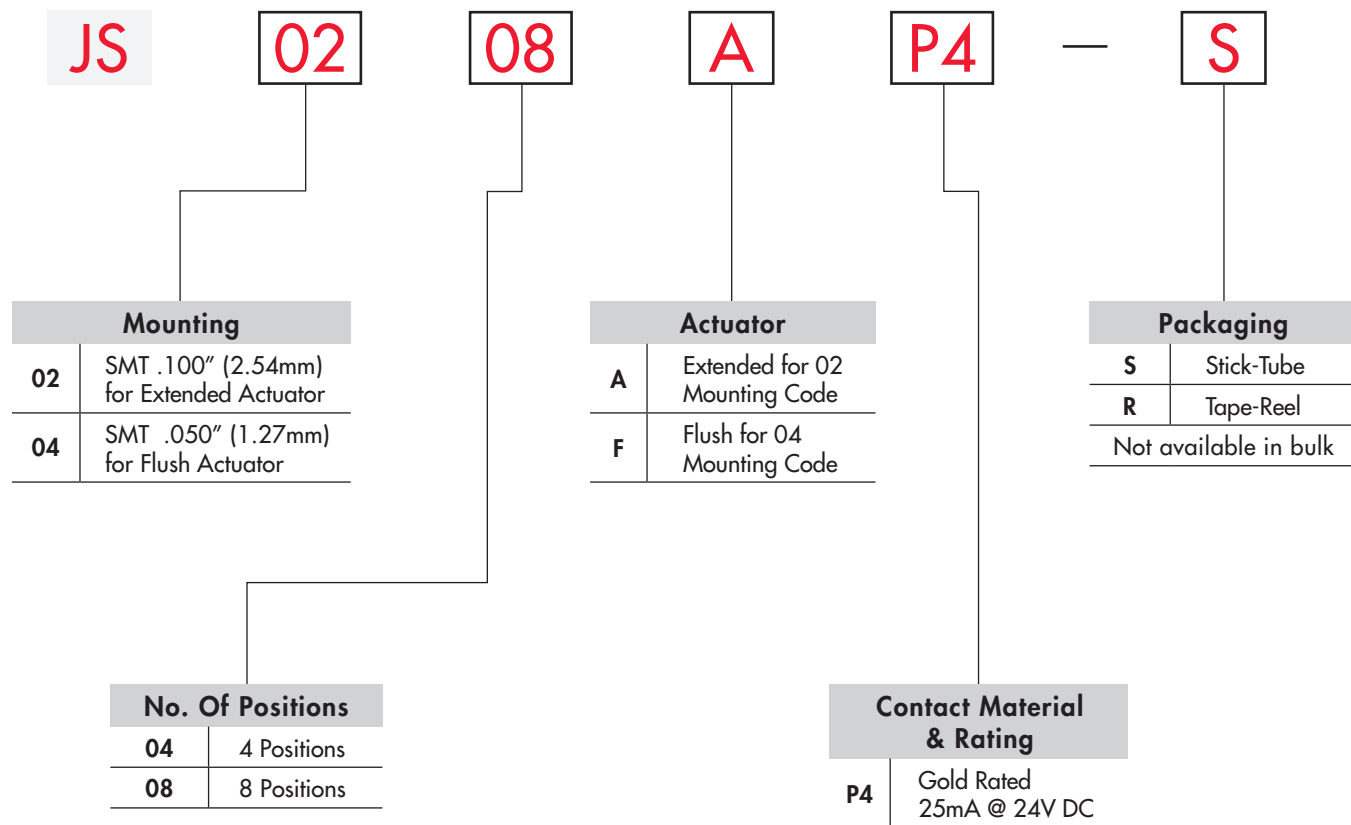

### DESCRIPTION FOR TYPICAL ORDERING EXAMPLE

**JS0208AP4-S**

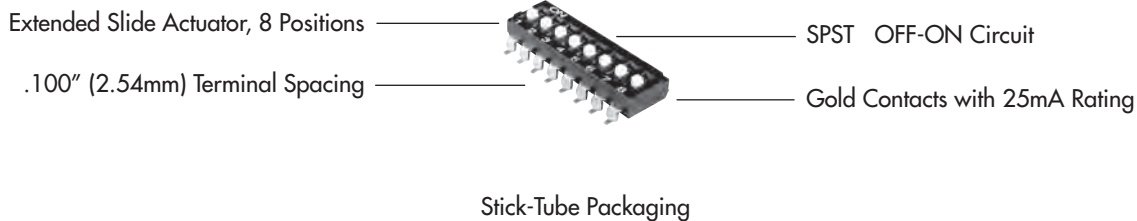

TYPICAL SWITCH DIMENSIONS

Single Pole

4 Positions • Extended Actuator

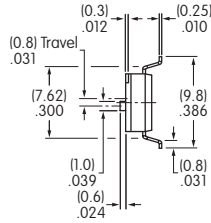
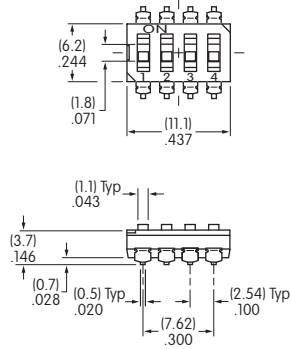

End View

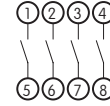
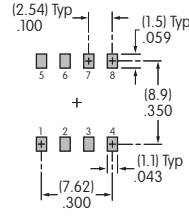

Schematic

JS0204AP4

Single Pole

8 Positions • Extended Actuator

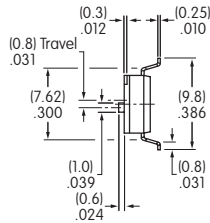
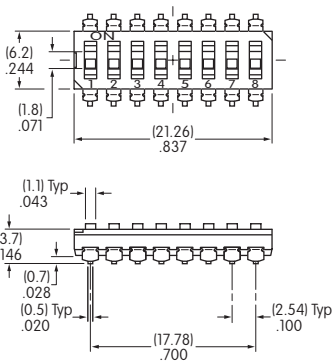

End View

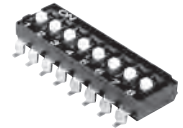
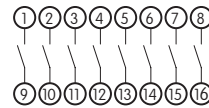
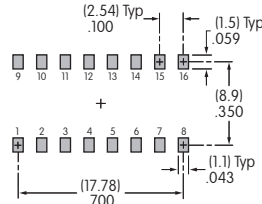

Schematic

JS0208AP4

Single Pole

4 Positions • Flush Actuator

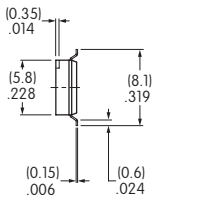
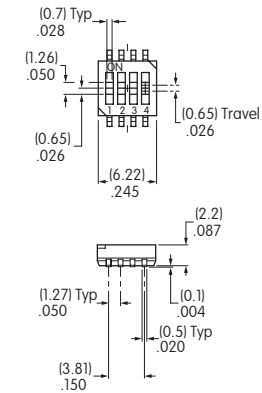

End View

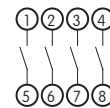
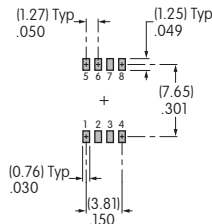

Schematic

JS0404FP4

Single Pole

8 Positions • Flush Actuator

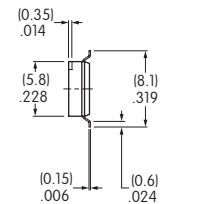
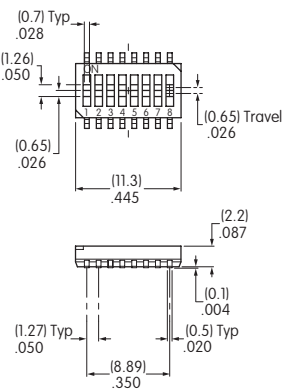

End View

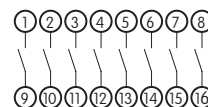
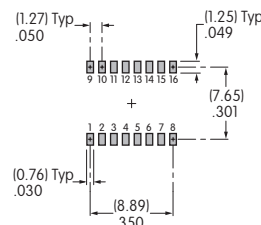

Schematic

JS0408FP4

### PACKAGING

**S**

#### Stick-Tube Packaging

Switches are packaged in OFF position.  
Switches are not available in bulk and must be ordered in the following increments:

##### Extended Actuator

JS0204AP4-S: 46 pieces per stick-tube  
JS0208AP4-S: 24 pieces per stick-tube



##### Flush Actuator

JS0404FP4-S: 80 pieces per stick-tube  
JS0408FP4-S: 45 pieces per stick-tube

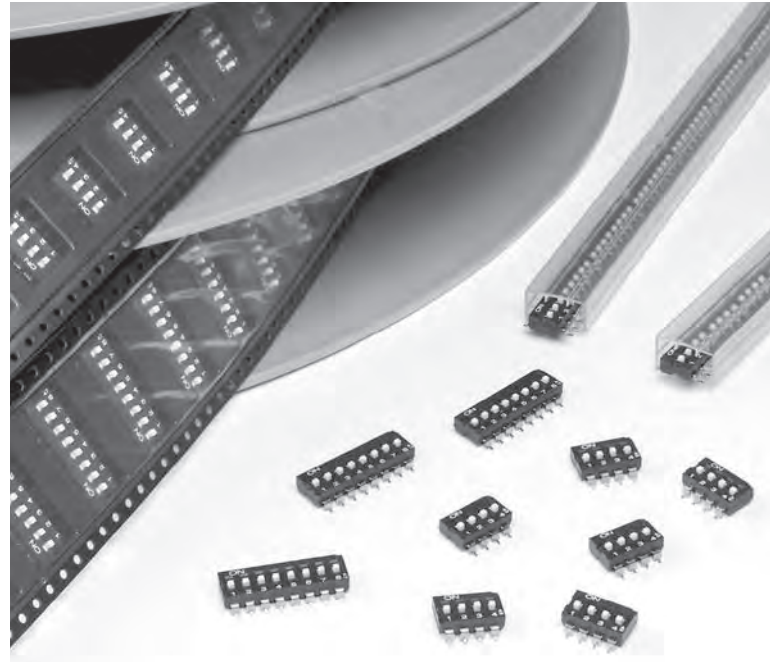
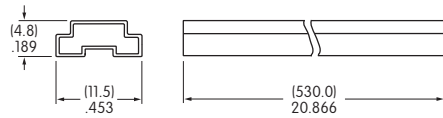

**R**

#### Tape-Reel Packaging for Extended Actuator

Switches are packaged in OFF position.  
Switches are not available in bulk and must be ordered in the following increments:

JS0204AP4-R: 500 pieces per tape-reel  
JS0208AP4-R: 500 pieces per tape-reel

Minimum Leader Length: 15.75" (400mm)  
Minimum Trailer Length: 6.3" (160mm)

Tape-reel packaging meets EIA-481-D Standard.

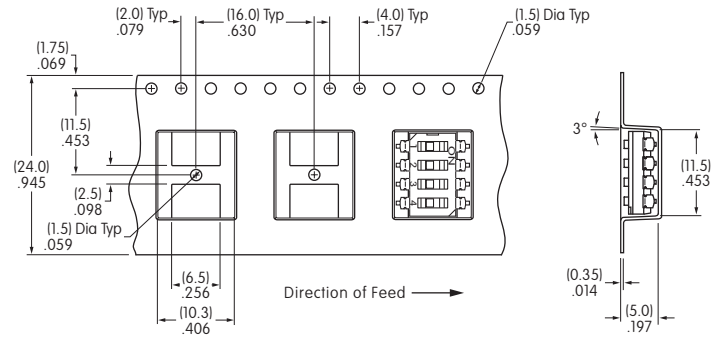

Tape Dimensions for JS0204AP4-R

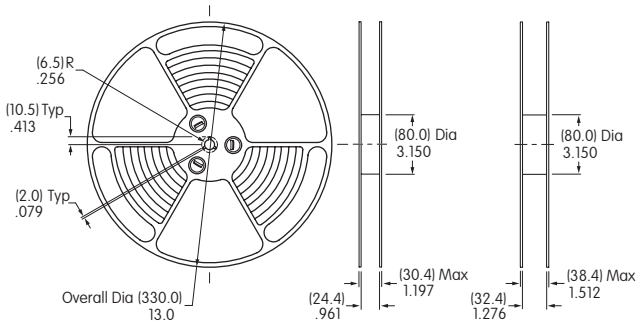

Reel Dimensions JS0204AP4-R JS0208AP4-R

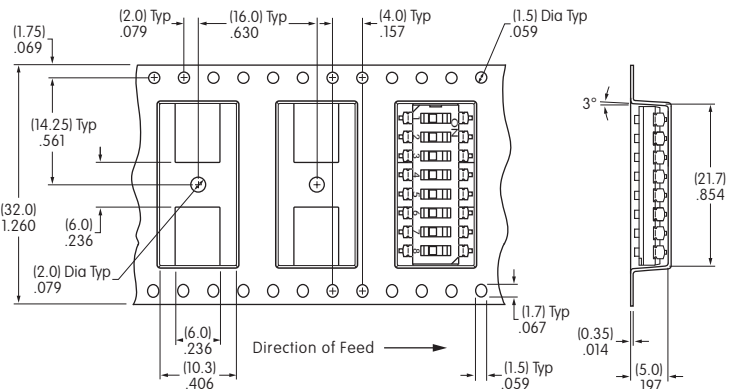

Tape Dimensions for JS0208AP4-R

Toggle

Rockers

Pushbuttons

Illuminated PB

Keylocks

Rotaries

Slides

Tactiles

Tilt

Touch

Indicators

Accessories

Supplement

PACKAGING (CONTINUED)

**R**

**Tape-Reel Packaging for Flush Actuator**

Switches are packaged in OFF position.  
Switches are not available in bulk and must be ordered in the following increments:

JS0404FP4-R: 2,000 pieces per tape-reel  
JS0408FP4-R: 2,000 pieces per tape-reel

Minimum Leader Length: 15.75" (400mm)  
Minimum Trailer Length: 6.3" (160mm)

Tape-reel packaging meets EIA-481-D Standard.

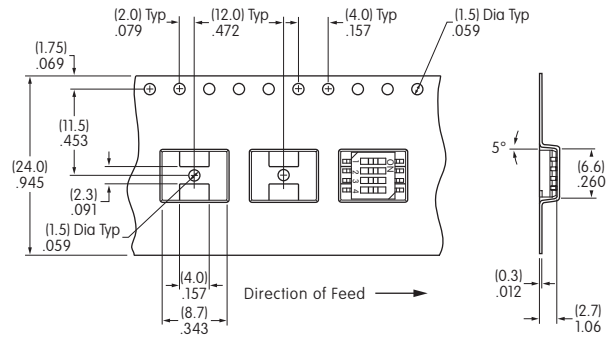

Tape Dimensions for JS0404FP4-R

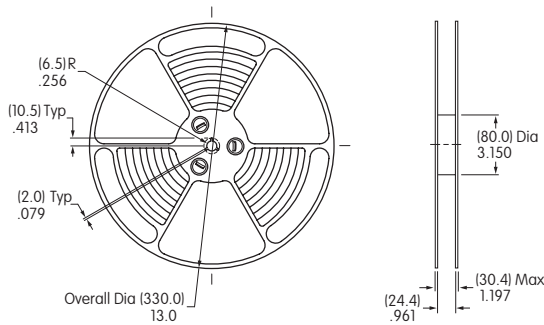

Reel Dimensions for JS0404FP4-R & JS0408FP4-R

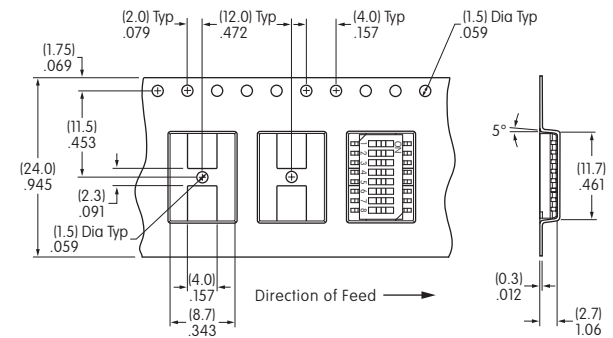

Tape Dimensions for JS0408FP4-R

Toggle

Rockers

Pushbuttons

Illuminated PB

Programmable

Key locks

Rotaries

**H** Slides

Tactiles

Tilt

Touch

Indicators

Accessories

Supplement

# General Specifications

## Electrical Capacity (Resistive Load)

<b>Power Level (silver):</b>	6A @ 125V AC or 3A @ 250V AC
<b>Logic Level (gold):</b>	0.4VA maximum @ 28V AC/DC maximum (Applicable Range 0.1mA ~ 0.1A @ 20mV ~ 28V)
<b>Logic/Power Level: (gold over silver)</b>	Combines silver & gold ratings

Note: Find additional explanation of dual rating & operating range in Supplement section.

## Other Ratings

<b>Contact Resistance:</b>	10 milliohms maximum for silver; 20 milliohms maximum for gold
<b>Insulation Resistance:</b>	1,000 megohms minimum @ 500V DC
<b>Dielectric Strength:</b>	1,000V AC minimum between contacts for 1 minute minimum; 1,500V AC minimum between contacts & case for 1 minute minimum
<b>Mechanical Life:</b>	100,000 operations minimum
<b>Electrical Life:</b>	25,000 operations minimum for silver; 50,000 operations minimum for gold
<b>Contact Timing:</b>	Nonshorting (break-before-make)
<b>Total Travel:</b>	On-None-On circuit .087" (2.2mm); all other circuits .138" (3.5mm)

## Materials & Finishes

<b>Actuator:</b>	Glass fiber reinforced PBT resin (UL94V-0)
<b>Frame:</b>	Stainless steel for panel & PCB mount; phosphor bronze with tin plating for bracket mount
<b>Dust Cover:</b>	Phosphor bronze with nickel plating
<b>Case:</b>	Glass fiber reinforced diallyl phthalate resin (UL94V-0)
<b>Movable Contacts:</b>	Silver alloy (code W); copper with gold plating (code G); or silver alloy with gold plating (code A)
<b>Stationary Contacts:</b>	Silver capped copper with silver plating (code W); copper with gold plating (code G); or silver alloy with gold plating (code A)
<b>Terminals:</b>	Copper or brass with silver or gold plating

## Environmental Data

<b>Operating Temp Range:</b>	-30°C through +85°C (-22°F through +185°F)
<b>Humidity:</b>	90 ~ 95% humidity for 96 hours @ 40°C (104°F)
<b>Vibration:</b>	10 ~ 55Hz with peak-to-peak amplitude of 1.5mm traversing the frequency range & returning in 1 minute; 3 right angled directions for 2 hours
<b>Shock:</b>	50G (490m/s <sup>2</sup> ) acceleration (tested in 6 right angled directions, with 5 shocks in each direction)

## Processing

<b>Soldering:</b>	Wave Soldering recommended (PC Mount). See Profile A in Supplement section. Manual Soldering: See Profile A in Supplement section.
<b>Cleaning:</b>	These devices are not process sealed. Hand clean locally using alcohol based solution.

## Standards & Certifications

<b>Flammability Standards:</b>	UL94V-0 rated actuator & case
<b>UL:</b>	<b>File No. E44145 - Recognized only when ordered with marking on switch.</b> Add "/U" or "/CUL" to end of part number to order UL recognized switch. All Single & Double Pole Double Throw models recognized at 6A @ 125V AC & 3A @ 250V AC.
<b>CSA:</b>	<b>File No. 023535_0_000 - Certified only when ordered with marking on switch.</b> Add "/C" to end of part number to order CSA certified switch. All Double Throw & 3 Throw models certified at 6A @ 125V AC, 3A @ 250V AC, & 0.4VA maximum @ 28V DC.



# Distinctive Characteristics

Available in flat frame and bracketed PC mounting types.

Over-center actuator block and plunger design gives crisp actuation with clear indication of circuit status; this design also diminishes sparking and increases operating life.

Guide interlocked with actuator block prevents window locking and maintains correct plunger alignment to assure contact stability.

Antijamming design protects contacts from damage due to excessive downward force on the actuator.

High internal barriers between poles and insulating sheet between case and actuator block give added protection to contacts.

Specially composed silver alloy contacts for power applications or gold contacts for logic level applications give high contact reliability.

Prominent external insulating barriers increase insulation resistance and dielectric strength.

Epoxy sealed terminals prevent entry of flux, solvents, and other contaminants.

Clinching of frame to case well above base and terminals provides 1,500V dielectric strength.

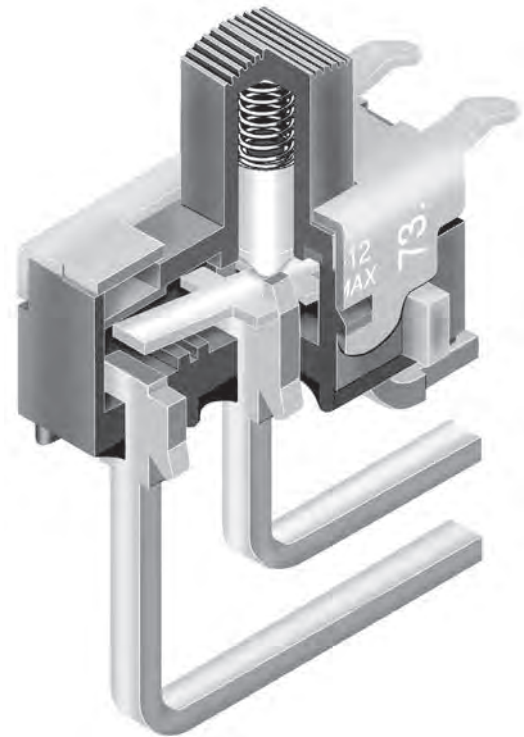

Actual Size

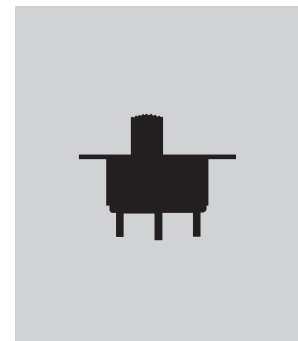

## TYPICAL SWITCH ORDERING EXAMPLE

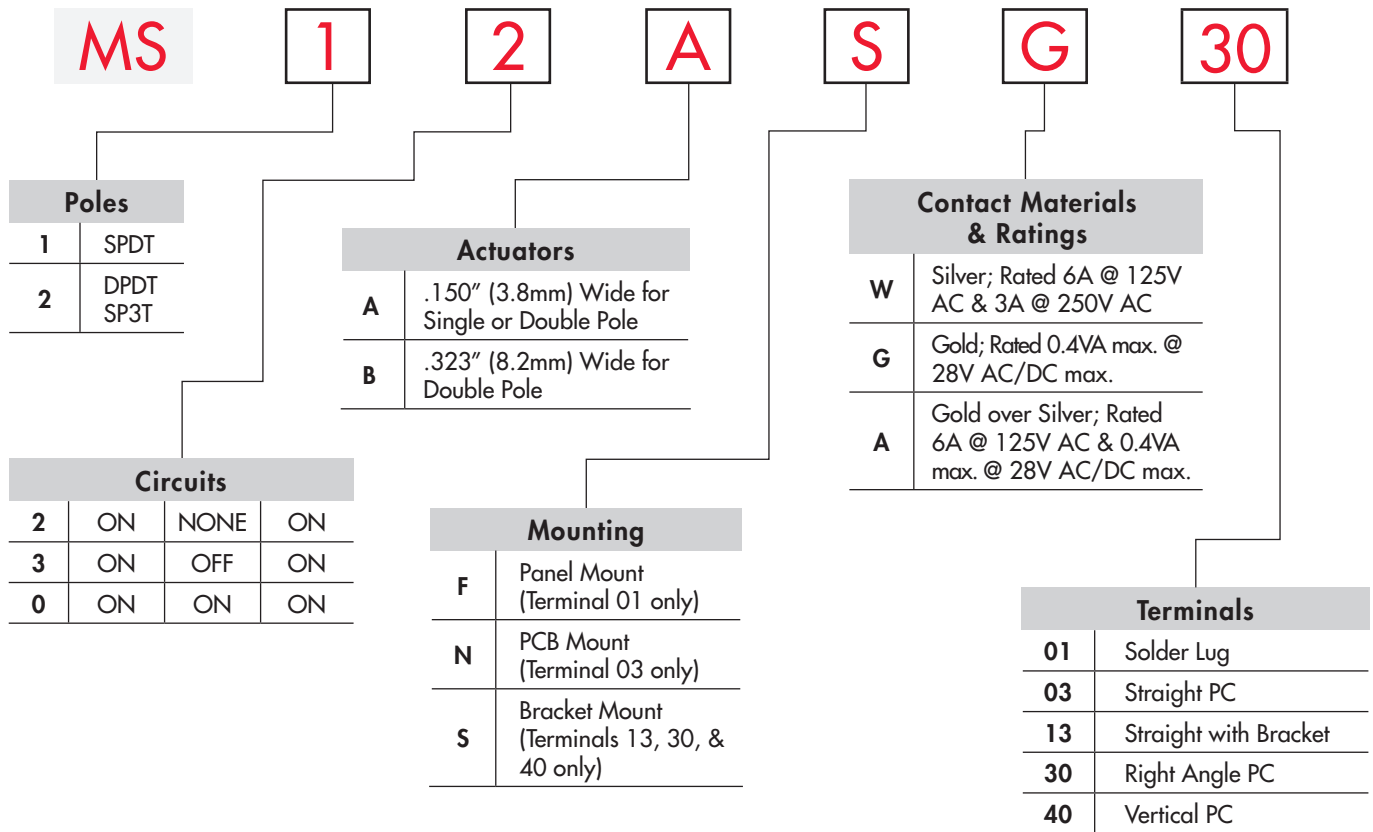

### IMPORTANT:



Switches are supplied without UL, cULus & CSA marking unless specified. **UL, cULus & CSA recognized only when ordered with marking on the switch.** Specific models, ratings, & ordering instructions are noted on the General Specifications page.

### DESCRIPTION FOR TYPICAL ORDERING EXAMPLE

#### MS12ASG30



## POLES & CIRCUITS

Pole	Model	Slide Position			Connected Terminals			Throw & Schematics
		Left	Center	Right	Left	Center	Right	
								Note: Terminal numbers are not actually on the switch.
SP	MS12 MS13	ON ON	NONE OFF	ON ON	2-1	OPEN	2-3	SPDT 
DP	MS22 MS23	ON ON	NONE OFF	ON ON	2-1 5-4	OPEN	2-3 5-6	DPDT 

### For 3 Throw (3-On)

Pole	Model	Connected Terminals & Schematics			External Connection
		Left	Center	Right	
SP	MS20	ON  2-1 5-4	ON  2-3 5-4	ON  2-3 5-6	The SP3T model utilizes a double pole base.  External connections must be made during field installation. 

## ACTUATORS

**A** .150" (3.8mm) Wide for Single Pole

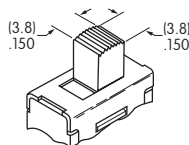

.150" (3.8mm) Wide for Double Pole

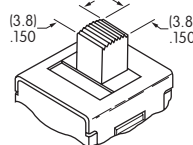

**B** .323" (8.2mm) Wide for Double Pole Only

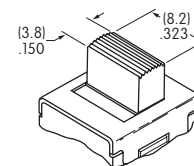

## CONTACT MATERIALS & RATINGS

**W** Silver over Silver Power Level 6A @ 125V AC & 3A @ 250V AC

**G** Gold over Brass or Copper Logic Level 0.4VA maximum @ 28V AC/DC maximum  
Note: Complete explanation of operating range in Supplement section.

**A** Gold over Silver Power Level or Logic Level 6A @ 125V AC or 0.4VA maximum @ 28V AC/DC maximum

Note: This dual rated option is suitable when two or more identical switches are used in logic and in power circuits within the same application. See Supplement section for complete explanation of dual rating and operating range.

## MOUNTING TYPES & TERMINALS

**F** Panel Mount  
(Combines with Solder Lug Terminal 01 only)

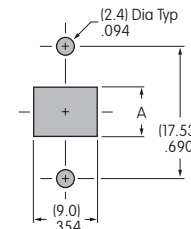
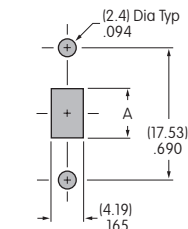

**N** Straight PC Mount  
(Combines with Straight PC Terminal 03 only)



Dimension A =  
.268" (6.8mm) for on-none-on  
.319" (8.1mm) for on-off-on & on-on-on

SP or DP with .150"  
(3.8mm) Actuator

DP only with .323"  
(8.2mm) Actuator

Maximum Panel Thickness: .197" (5.0mm)

**S** Support Bracket Mount  
(For Terminals 13, 30, & 40)



Maximum Panel Thickness:  
For Straight PC with Bracket Terminal 13: .197" (5.0mm)  
For Angle Mount Terminals 30 & 40: .177" (4.5mm)

**01** Solder Lug

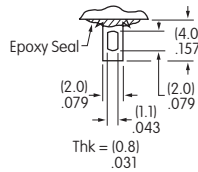

**03** Straight PC

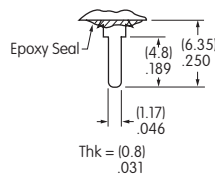

**13** Straight PC with Bracket

**30** Right Angle PC

**40** Vertical PC

## TYPICAL SWITCH DIMENSIONS

Solder Lug Terminals

Single Pole

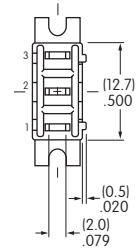
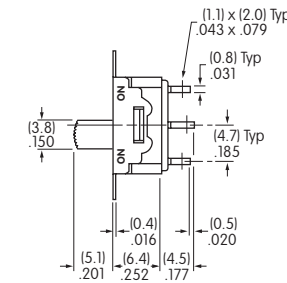
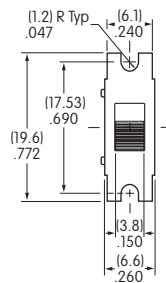

MS12AFW01

Actuator in LEFT Position

Solder Lug Terminals

Double Pole

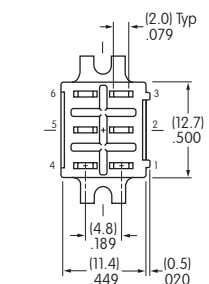
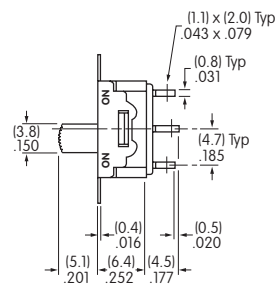
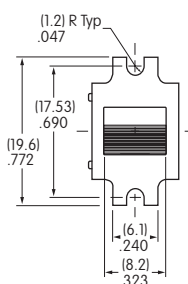
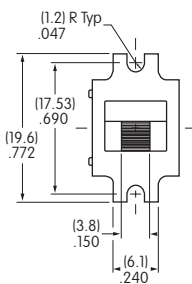

MS22BFW01

Actuator in LEFT Position

## TYPICAL SWITCH DIMENSIONS

### Single Pole

### Straight PC Terminals

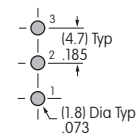
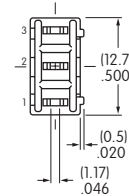
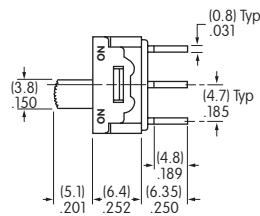
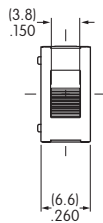

Actuator in LEFT Position

**MS12ANG03**

### Double Pole

### Straight PC Terminals

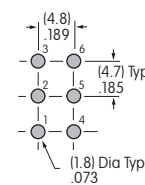
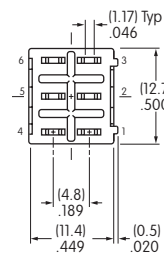
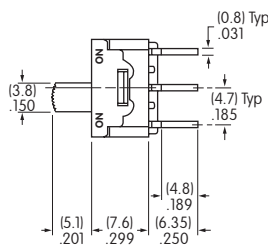
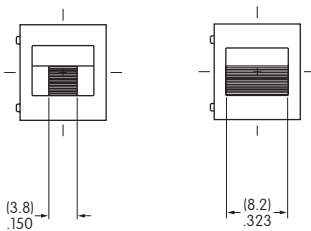

Actuator in LEFT Position

**MS22BNG03**

### Single Pole

### Straight PC Terminals with Bracket

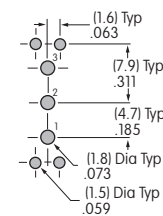
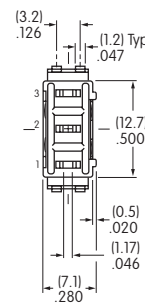
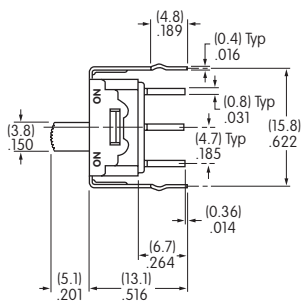
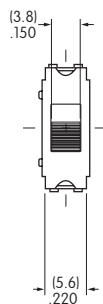

Actuator in LEFT Position

**MS12ASG13**

### Double Pole

### Straight PC Terminals with Bracket

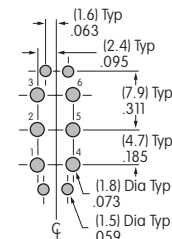
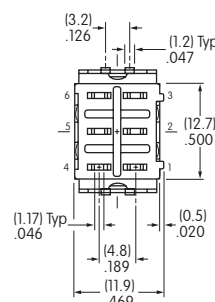
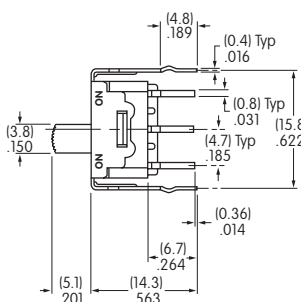
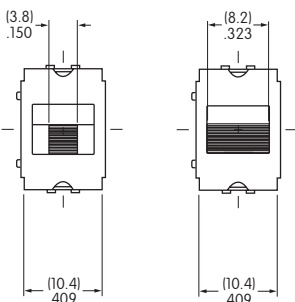

Actuator in LEFT Position

**MS22BSG13**

## TYPICAL SWITCH DIMENSIONS

### Right Angle PC Terminals

### Single Pole

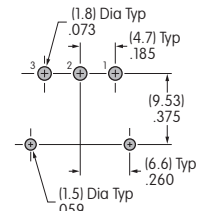
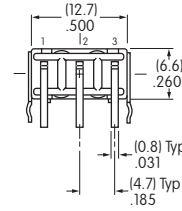
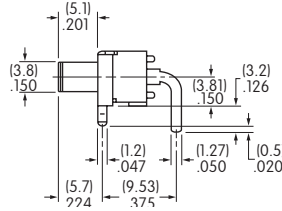
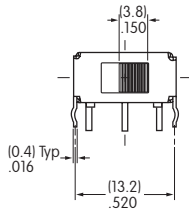

**MS12ASG30**

Actuator in LEFT Position

### Right Angle PC Terminals

### Double Pole

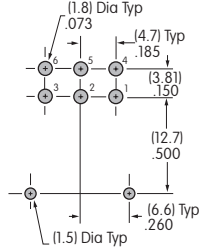
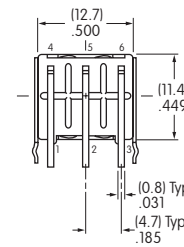
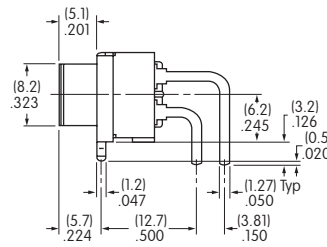
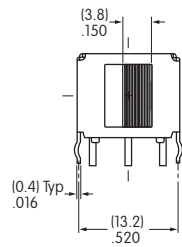
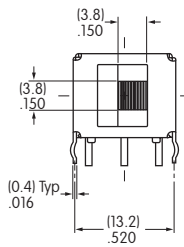

**MS22BSG30**

Actuator in LEFT Position

### Vertical PC Terminals

### Single Pole

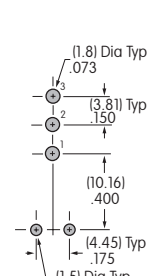
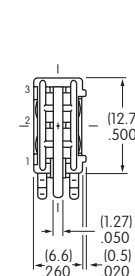
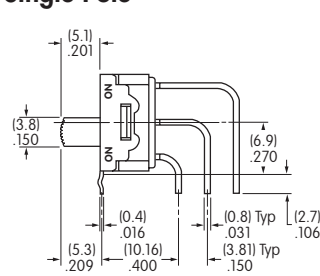
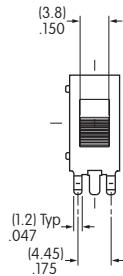

**MS12ASG40**

Actuator in LEFT Position

### Vertical PC Terminals

### Double Pole

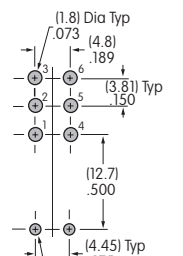
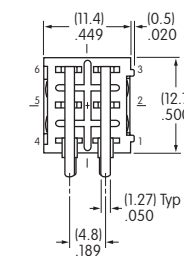
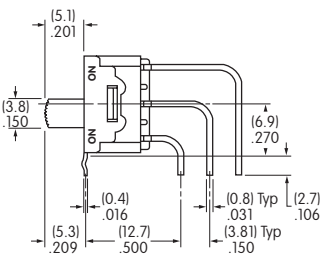
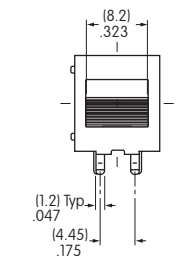
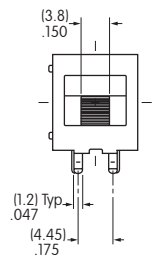

**MS22BSG40**

Actuator in LEFT Position



# General Specifications

## Electrical Capacity (Resistive Load)

**Power Level:** 6A @ 125V AC or 3A @ 250V AC

## Other Ratings

**Contact Resistance:** 10 milliohms maximum

**Insulation Resistance:** 1,000 megohms minimum @ 500V DC

**Dielectric Strength:** 1,000V AC minimum between contacts for 1 minute minimum;  
1,500V AC minimum between contacts & case for 1 minute minimum

**Mechanical Life:** 50,000 operations minimum

**Electrical Life:** 25,000 operations minimum

**Contact Timing:** Nonshorting (break-before-make)

**Total Travel:** .087" (2.2mm)

## Materials & Finishes

**Actuator:** Polyamide (UL94V-0)

**Frame:** Stainless steel

**Case:** Glass fiber reinforced diallyl phthalate resin (UL94V-0)

**Movable Contacts:** Silver alloy

**Stationary Contacts:** Silver capped copper with silver plating

**Terminals:** Copper or brass with silver plating

## Environmental Data

**Operating Temp Range:** -10°C through +55°C (+14°F through +131°F)

**Humidity:** 90 ~ 95% humidity for 96 hours @ 40°C (104°F)

**Vibration:** 10 ~ 55Hz with peak-to-peak amplitude of 1.5mm traversing the frequency range  
& returning in 1 minute; 3 right angled directions for 2 hours

**Shock:** 50G (490m/s<sup>2</sup>) acceleration (tested in 6 right angled directions, with 5 shocks in each direction)

## Processing

**Soldering Time & Temp:** Wave Soldering Recommended (PC version): See Profile A in Supplement section.

Manual Soldering: See Profile A in Supplement section.

Note: Lever must be in center position while soldering.

**Cleaning:** These devices are not process sealed. Hand clean locally using alcohol based solution.

## Standards & Certifications

**Flammability Standards:** UL94V-0 rated actuator & case



# Distinctive Characteristics

Bright, LED illumination at top of actuator.

Over-center actuator block and plunger design gives crisp actuation, diminishes sparking, and increases operating life.

Guide interlocked with actuator block prevents window locking and maintains correct plunger alignment to assure contact stability.

Antijamming design protects contacts from damage due to excessive downward force on the actuator.

High internal barriers between poles and insulating sheet between case and actuator block give added protection to contacts.

Prominent external insulating barriers increase insulation resistance and dielectric strength.

Epoxy sealed terminals prevent entry of flux, solvents, and other contaminants.

Clinching of frame to case well above base and terminals provides 1,500V dielectric strength.

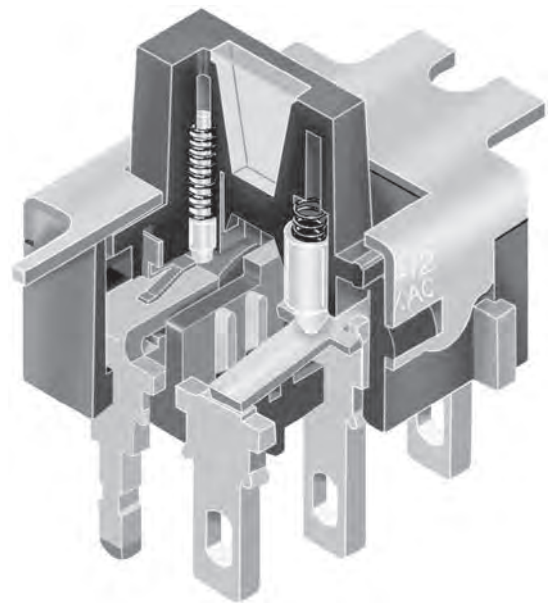

Actual Size

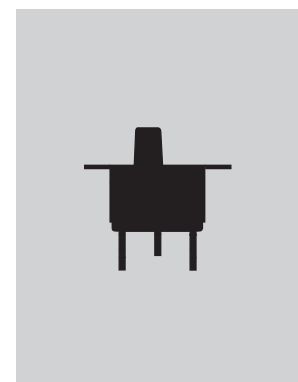

Toggle

Rockers

Pushbuttons

Illuminated PB

Programmable

Key locks

Rotaries

**H** Slides

Tactiles

Tilt

Touch

Indicators

Accessories

Supplement

### TYPICAL SWITCH ORDERING EXAMPLE

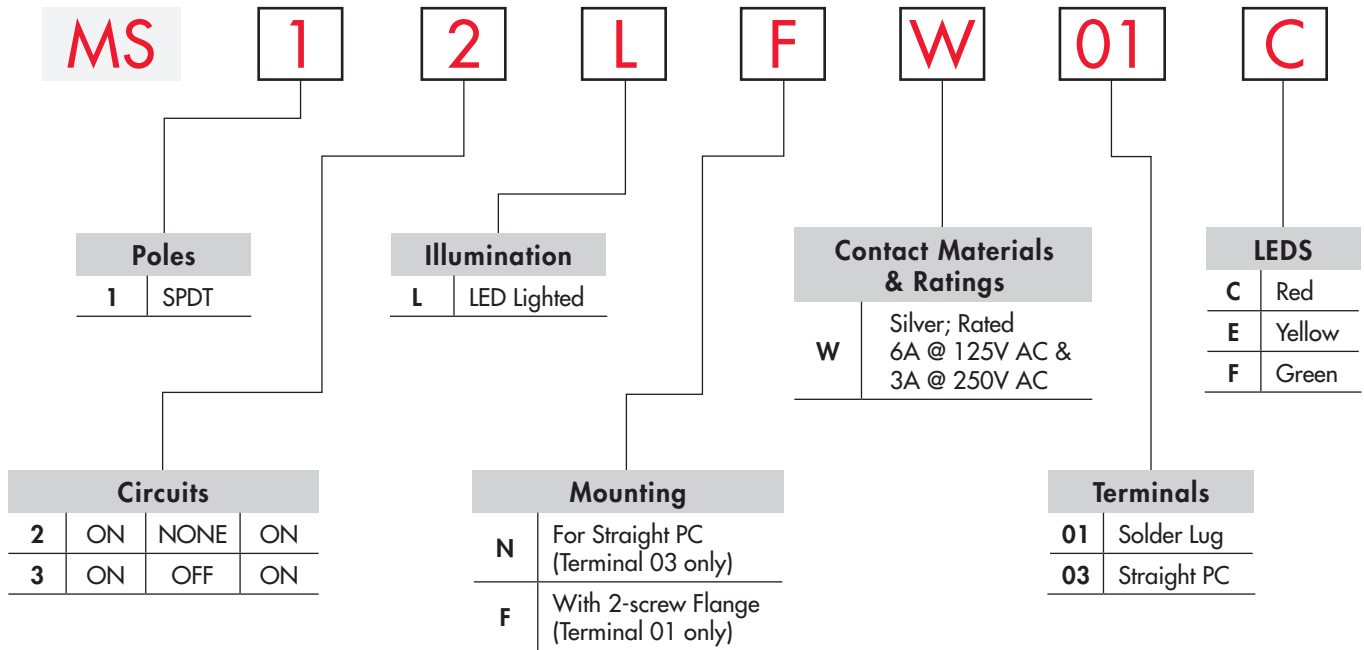

### DESCRIPTION FOR TYPICAL ORDERING EXAMPLE

#### MS12LFW01C

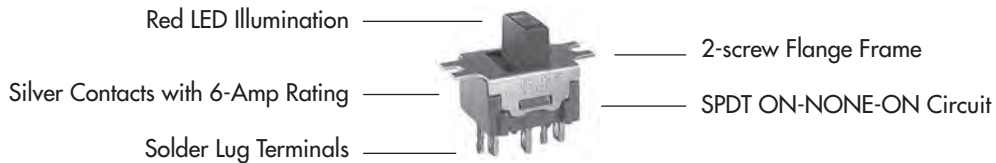

### POLES & CIRCUITS

Pole	Model	Slide Position			Connected Terminals			Throw & Schematics
		Left	Center	Right	Left	Center	Right	
SP	MS12	ON	NONE	ON	2-1	OPEN	2-3	Note: Terminal numbers are not actually on the switch. LED circuit is isolated and requires an external connection. 
	MS13	ON	OFF	ON				

### CONTACT MATERIALS & RATINGS

<b>W</b>	Silver over Silver	Power Level	6A @ 125V AC & 3A @ 250V AC
----------	--------------------	-------------	-----------------------------

## MOUNTING TYPES & TERMINALS

**N** Straight PC Mount  
(Combines with  
Straight PC Terminal  
03 only)



**03** Straight PC

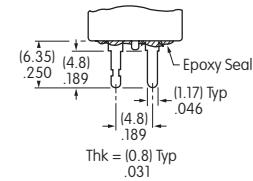

**F** 2-screw Flange  
(Combines with Solder  
Lug Terminal 01 only)



**01** Solder Lug

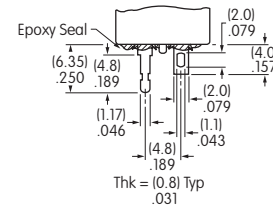

## LED COLORS & SPECIFICATIONS

LEDs are supplied as an integral part of the switch (not available separately). The lamp circuit is independent of switch operation. Electrical specifications shown are determined at a basic temperature of 25°C. If the source voltage exceeds the rated voltage, a ballast resistor is required. The resistor value can be calculated by using the formula given in the Supplement.

		<b>C</b> Red	<b>E</b> Yellow	<b>F</b> Green
Maximum Forward Current	$I_{FM}$	30mA	30mA	25mA
Typical Forward Current	$I_F$	16mA	16mA	16mA
Forward Voltage	$V_F$	1.98V	2.06V	2.16V
Maximum Reverse Voltage	$V_{RM}$	5V	5V	5V
Current Reduction Rate Above 25°C	$\Delta I_F$	0.40mA/°C	0.42mA/°C	0.33mA/°C
Ambient Temperature Range		-15° ~ +60°C		

## TYPICAL SWITCH DIMENSIONS

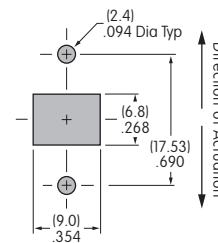
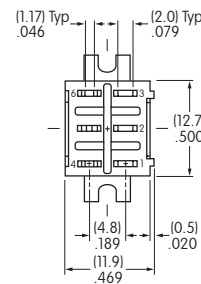
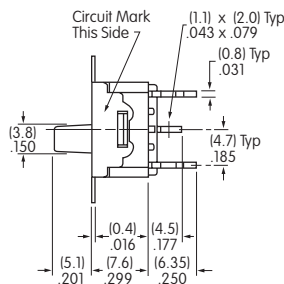
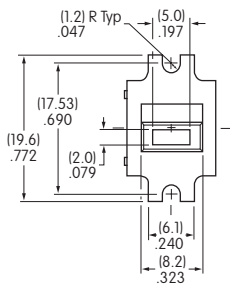

Actuator in LEFT Position

Maximum Panel Thickness .197" (5.0mm)

**MS12LFW01C**

## Straight PC Terminals

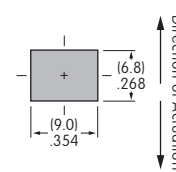
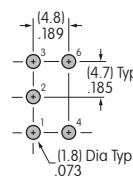
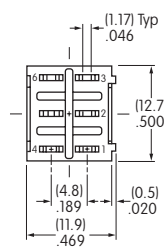
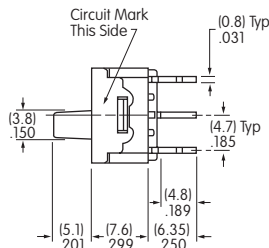
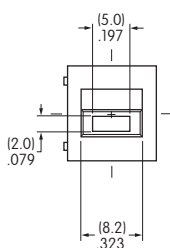

Actuator in LEFT Position

Maximum Panel Thickness .197" (5.0mm)

**MS12LNW03C**

# General Specifications

Toggles

Rockers

Pushbuttons

Programmable Illuminated PB

Keylocks

Rotaries

Slides

Tactiles

Tilt

Touch

Indicators

Accessories

Supplement

## Electrical Capacity (Resistive Load)

<b>Maximum Level:</b>	500mA @ 12V DC
<b>Minimum Level:</b>	1.0mA maximum @ 10mV AC/DC maximum

## Other Ratings

<b>Contact Resistance:</b>	30 milliohms maximum
<b>Insulation Resistance:</b>	100 megohms minimum @ 500V DC
<b>Dielectric Strength:</b>	500V AC for 1 minute minimum
<b>Mechanical Life:</b>	1,000 operations minimum
<b>Electrical Life:</b>	1,000 operations minimum
<b>Nominal Operating Force:</b>	2.0N
<b>Contact Timing:</b>	Nonshorting (Break-before-make)
<b>Total Travel:</b>	.063" (1.6mm)

## Materials & Finishes

<b>Actuator:</b>	Glass fiber reinforced polyester (UL94V-0)
<b>Case:</b>	Glass fiber reinforced polyamide (UL94V-0)
<b>Lower Case:</b>	Glass fiber reinforced polyester (UL94V-0)
<b>Movable Contacts:</b>	Brass with gold plating over nickel
<b>Stationary Contacts:</b>	Brass with gold plating over nickel
<b>Terminals:</b>	Brass with gold plating over nickel

## Environmental Data

<b>Operating Temp Range:</b>	-40°C through +85°C (-40°F through +185°F)
<b>Humidity:</b>	90-95% humidity for 96 hours @ 40°C (104°F)
<b>Vibration:</b>	10 ~ 55Hz with peak-to-peak amplitude of 1.5mm traversing the frequency range & returning in 1 minute; 3 right angled directions for 2 hours
<b>Shock:</b>	50G (490m/s <sup>2</sup> ) acceleration (tested in 6 right angled directions, with 5 shocks in each direction)

## PCB Processing

<b>Soldering:</b>	Wave Soldering Recommended: See Profile A in Supplement section. Manual Soldering: See Profile B in Supplement section.
<b>Cleaning:</b>	These devices are not process sealed. Hand clean locally using alcohol based solution.

## Standards & Certifications

<b>Flammability Standards:</b>	Actuator and lower case of glass fiber reinforced polyester and case of glass fiber reinforced polyamide UL94V-0 The SM series devices have not been tested for UL recognition and CSA certification. These switches are designed for use in a low-voltage, low-current circuit. When used as intended in a low-voltage, low-current circuit, the results do not produce hazardous energy.
--------------------------------	---

# Distinctive Characteristics

Very compact dimensions allow for high density, side-by-side or end-to-end mounting within tight dimensional applications.

Detent mechanism provides positive actuation to indicate circuit status.

Visible indication of position by spot on top of red actuator and through window on side.

Twin sliding contact mechanism with self-cleaning action provides smooth actuation and produces high contact reliability.

.100" x .100" (2.54mm x 2.54mm) center-to-center inch terminal spacing allows standard PC board mounting in side-by-side or end-to-end arrangements.

Insert molded terminals lock out flux, solvents, and other contaminants.

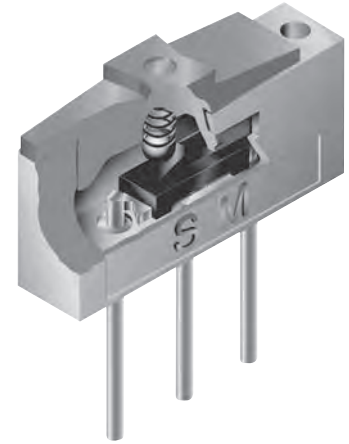

Actual Size

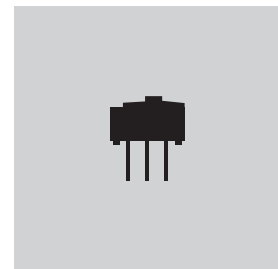

## POLES & CIRCUITS

Model	Slide Position			Connected Terminals			Throw & Schematics
	Right	Center	Left	Right	Center	Left	
							Note: Terminal numbers are on the switch. SPDT
SM0320102	ON	NONE	ON	1-3	OPEN	1-2	

## TYPICAL SWITCH DIMENSIONS

Single Pole • Straight PC

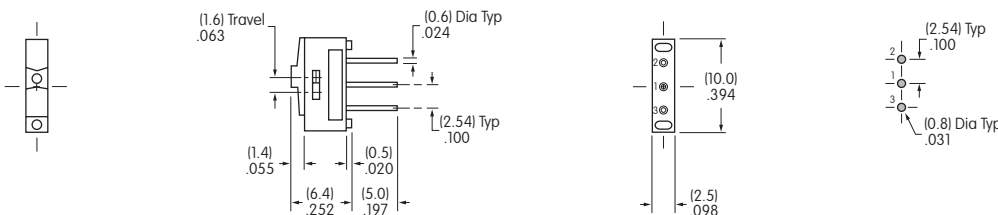

Actuator shown in RIGHT position



SM0320102

- Toggle
- Rockers
- Pushbuttons
- Illuminated PB
- Programmable
- Key locks
- Rotaries
- H Slides**
- Tactiles
- Tilt
- Touch
- Indicators
- Accessories
- Supplement

# General Specifications

## Electrical Capacity (Resistive Load)

<b>Power Level (silver):</b>	0.1A @ 30V DC
<b>Logic Level (gold):</b>	0.4VA maximum @ 28V AC/DC maximum (Applicable Range 0.1mA ~ 0.1A @ 20mV ~ 28V)
	Note: Find additional explanation of operating range in Supplement section.

## Other Ratings

<b>Contact Resistance:</b>	20 milliohms maximum for power level; 40 milliohms maximum for logic level
<b>Insulation Resistance:</b>	100 megohms minimum @ 500V DC
<b>Dielectric Strength:</b>	500V AC minimum 1 minute minimum
<b>Mechanical Life:</b>	10,000 operations minimum
<b>Electrical Life:</b>	10,000 operations minimum
<b>Contact Timing:</b>	SS12S & SS22S – Shorting (make-before-break)
<b>Total Travel:</b>	.079" (2.0mm)

## Materials & Finishes

<b>Actuator:</b>	Polyamide
<b>Upper Case:</b>	Polyester for 3-On models; polyacetal for all other models
<b>Lower Case:</b>	Glass fiber reinforced polyester for 3-On models; glass fiber reinforced polybutylene terephthalate (thermoplastic) for other models
<b>Movable Contactor:</b>	Phosphor bronze with silver plating (code 2) or phosphor bronze with gold plating (code 4)
<b>Interior Base:</b>	Phenolic resin (thermoset)
<b>Terminals:</b>	Brass with silver plating over copper plating or brass with gold plating

## Environmental Data

<b>Operating Temp Range:</b>	-15°C through +60°C (+5°F through +140°F)
<b>Humidity:</b>	90 ~ 95% humidity for 96 hours @ 40°C (104°F)
<b>Vibration:</b>	10 ~ 55Hz with peak-to-peak amplitude of 1.5mm traversing the frequency range & returning in 1 minute; 3 right angled directions for 2 hours
<b>Shock:</b>	50G (490m/s <sup>2</sup> ) acceleration (tested in 6 right angled directions, with 5 shocks in each direction)

## PCB Processing

<b>Soldering:</b>	Wave Soldering: For non-supported through-hole, see Profile B in Supplement section. For supported through-hole, 5 seconds maximum @ 250°C maximum. Manual Solder: See Profile B in Supplement section.
<b>Cleaning:</b>	These devices are not process sealed. Hand clean locally using alcohol based solution.

## Standards & Certifications

The SS series devices have not been tested for UL recognition and CSA certification. These switches are designed for use in a low-voltage, low-current circuit. When used as intended in a low-voltage, low-current circuit, the results do not produce hazardous energy.

# Distinctive Characteristics

Top or side actuation permits flexible board design.

Compact dimensions and low profile allow high density mounting and close stacking of PC boards.

Crisp actuation positively indicates circuit status.

Double molded thermoset base and thermo-plastic housing prevent loosening of terminals due to high soldering temperatures.

Award-winning STC mechanism with benefits unavailable in conventional mechanisms: smoother, positive detend actuation, increased contact stability, and unparalleled logic-level reliability. (Additional STC details in Terms and Acronyms in the Supplement section.)

Insert molded terminals lock out flux, solvents, and other contaminants.

Inch or metric terminal spacing for standard PC board grid (.100" x .100" or 2.0mm x 2.0mm).

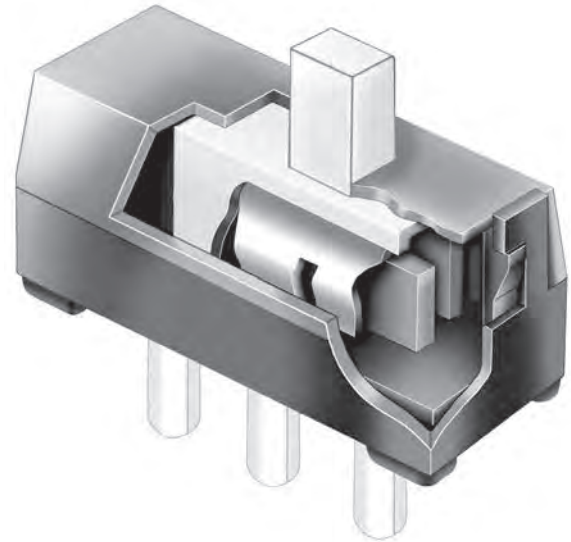

Actual Size

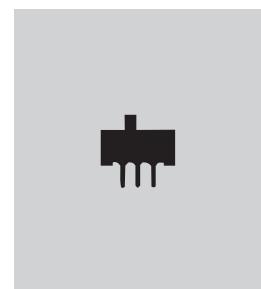

## TYPICAL SWITCH ORDERING EXAMPLE

**SS**

**12S**

**D**

**P**

**2**

### Poles & Circuits

<b>12S</b>	SPDT	ON	NONE	ON
SS12S model has shorting contacts.				
<b>*14M</b>	SP3T	ON	ON	ON
<b>22S</b>	DPDT	ON	NONE	ON
SS22S model has shorting contacts.				
See Poles & Circuits chart below.				
* 14M Circuit with silver contacts only.				

### Terminal Spacing

<b>B</b>	Metric 2.0mm x 2.0mm
<b>D</b>	Inch .100" x .100"

### Contact Material & Ratings

<b>2</b>	Silver Rated 0.1A @ 30V DC
<b>*4</b>	Gold Rated 0.4VA maximum @ 28V AC/DC maximum
* Gold not available with SS14M.	

### Actuation

<b>P</b>	Top Actuated
<b>H</b>	Side Actuated

## DESCRIPTION FOR TYPICAL ORDERING EXAMPLE

**SS12SDP2**

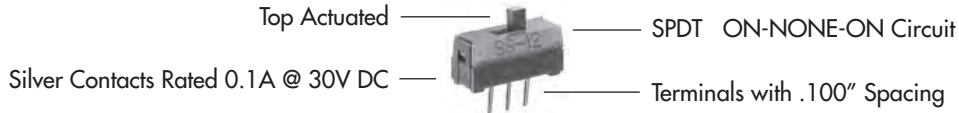

## POLES & CIRCUITS

Pole	Model	Slide Position			Connected Terminals			Throw & Schematics
		Right	Center	Left	Right	Center	Left	
SP	<b>SS12S</b>	ON	NONE	ON	2-1	NONE	2-3	SPDT 
SP	<b>SS14M</b>	ON	ON	ON	3-4	3-2	3-1	SP3T 
DP	<b>SS22S</b>	ON	NONE	ON	2-1 5-4	NONE	2-3 5-6	DPDT 



TERMINAL SPACING

**B** Metric 2.0mm x 2.0mm with Black Base

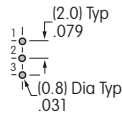
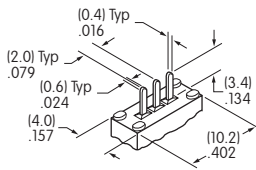

On-None-On Single Pole Models

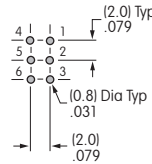
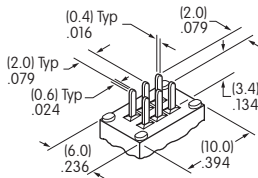

On-None-On Double Pole Models

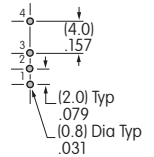
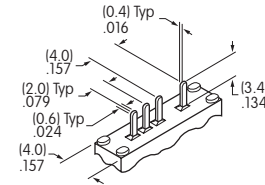

3-On Models

**D** Inch .100" x .100" with Gray Base

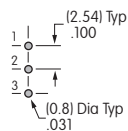
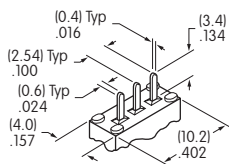

On-None-On Single Pole Models

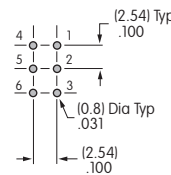
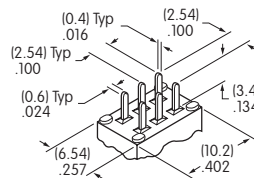

On-None-On Double Pole Models

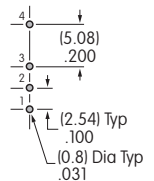
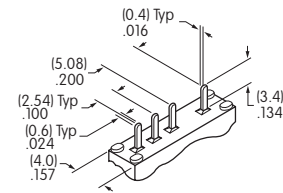

3-On Models

ACTUATION

**P** Top Actuated

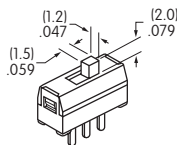

**H** Side Actuated

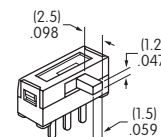

CONTACT MATERIALS & RATINGS

**2** Silver over Phosphor Bronze

Power Level

0.1A @ 30V DC

**4** Gold over Silver/Phosphor Bronze

Logic Level

0.4VA max @ 28V AC/DC max

Complete explanation of operating range in Supplement section.

## TYPICAL SWITCH DIMENSIONS

### Top Actuated

### Single & Double Pole

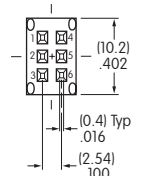
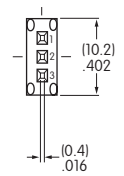
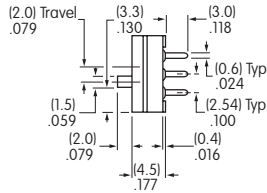
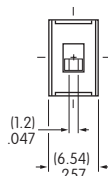
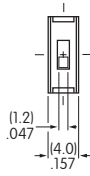

SS12SDP2

### Side Actuated

### Single & Double Pole

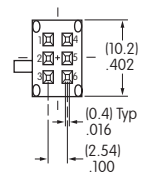
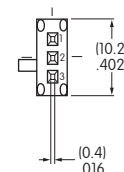
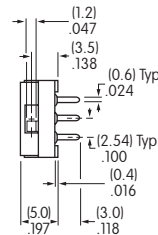
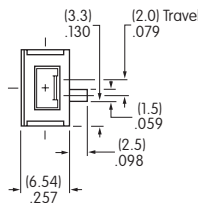
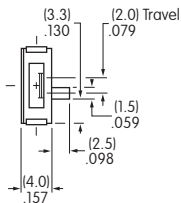

SS12SDH2

### 3-On Circuit • Top Actuated

### Single Pole

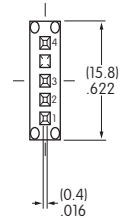
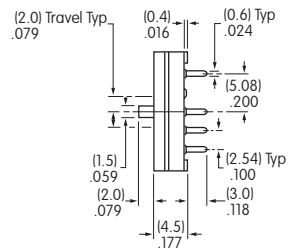
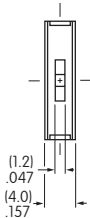

SS14MDP2

### 3-On Circuit • Side Actuated

### Single Pole

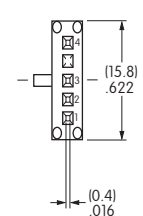
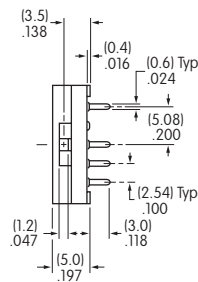
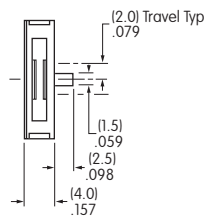

SS14MDH2

# Distinctive Characteristics

Top or side actuation permits flexible board design.

Bright, LED illumination at tip of actuator.

Compact dimensions and low profile allow high density mounting and close stacking of PC boards.

Crisp actuation positively indicates circuit status.

Double molded thermoset base and thermoplastic housing prevent loosening of terminals due to high soldering temperatures.

Sliding twin contact mechanism with self-cleaning action provides smooth actuation and produces high contact reliability.

Insert molded terminals lock out flux, solvents, and other contaminants.

Inch terminal spacing for standard PC board grid (.100" x .100").

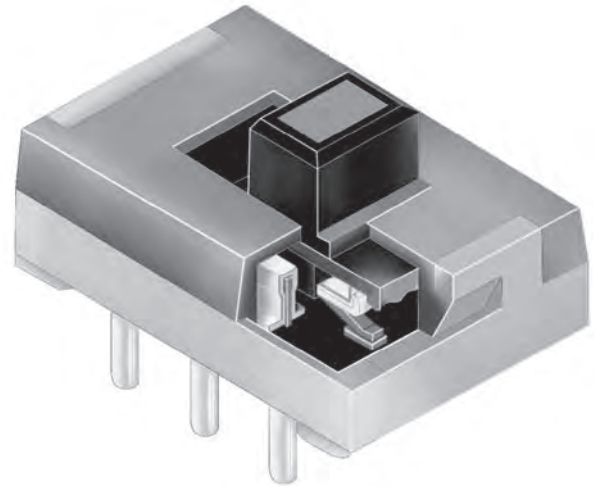

Actual Size

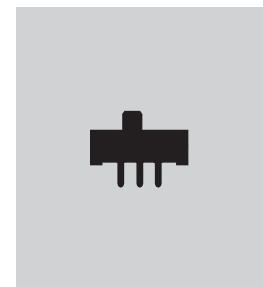

# General Specifications

## Electrical Capacity (Resistive Load)

Power Level: 0.1A @ 30V DC

## Other Ratings

<b>Contact Resistance:</b>	20 milliohms maximum
<b>Insulation Resistance:</b>	100 megohms minimum @ 500V DC
<b>Dielectric Strength:</b>	500V AC minimum 1 minute minimum
<b>Mechanical Life:</b>	10,000 operations minimum
<b>Electrical Life:</b>	10,000 operations minimum
<b>Contact Timing:</b>	Shorting (make-before-break)
<b>Total Travel:</b>	.079" (2.0mm)

## Materials & Finishes

<b>Actuator:</b>	Polyacetal
<b>Upper Case:</b>	Polyacetal
<b>Lower Case:</b>	Glass fiber reinforced polyester
<b>Movable Contactor:</b>	Phosphor bronze with silver plating
<b>Interior Base:</b>	Phenolic resin (thermoset)
<b>Terminals:</b>	Brass with silver plating over copper plating

## Environmental Data

<b>Operating Temp Range:</b>	-15°C through +60°C (+5°F through +140°F)
<b>Humidity:</b>	90 ~ 95% humidity for 96 hours @ 40°C (104°F)
<b>Vibration:</b>	10 ~ 55Hz with peak-to-peak amplitude of 1.5mm traversing the frequency range & returning in 1 minute; 3 right angled directions for 2 hours
<b>Shock:</b>	50G (490m/s <sup>2</sup> ) acceleration (tested in 6 right angled directions, with 5 shocks in each direction)

## PCB Processing

<b>Soldering:</b>	Wave Soldering: For non-supported through-hole, see Profile B in Supplement section. For supported through-hole, 5 seconds maximum @ 250°C maximum. Manual Soldering: See Profile B in Supplement section.
<b>Cleaning:</b>	These devices are not process sealed. Hand clean locally using alcohol based solution.

## Standards & Certifications

The SS series devices have not been tested for UL recognition and CSA certification. These switches are designed for use in a low-voltage, low-current circuit. When used as intended in a low-voltage, low-current circuit, the results do not produce hazardous energy.

TYPICAL SWITCH ORDERING EXAMPLE

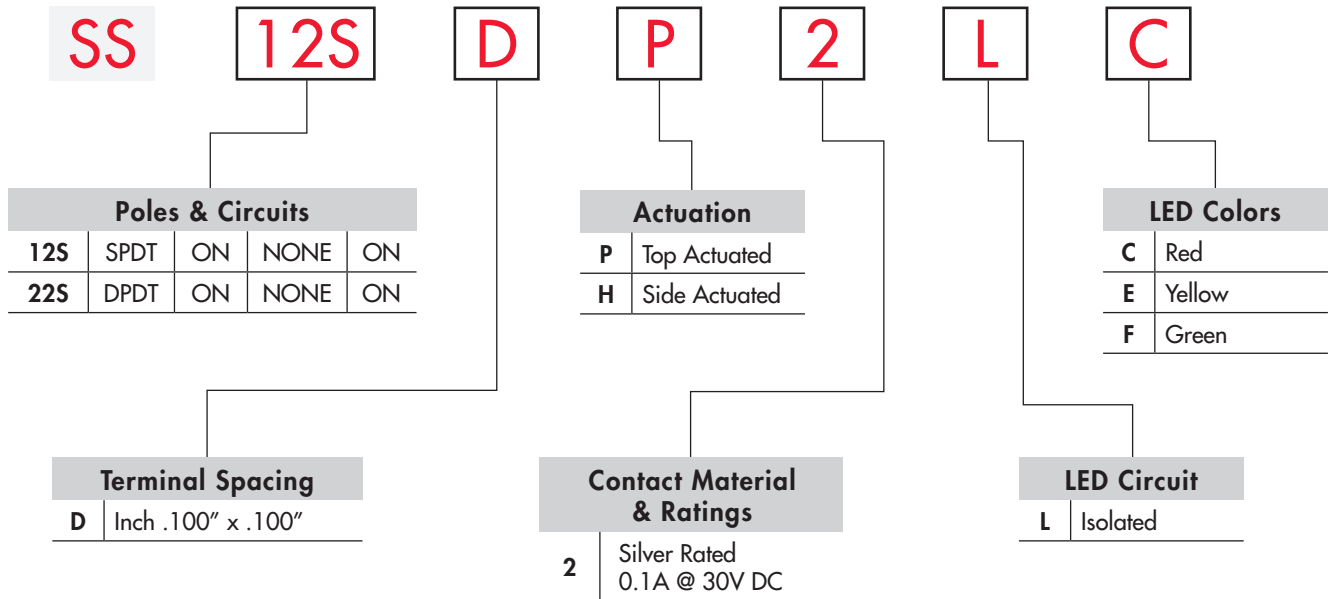

DESCRIPTION FOR TYPICAL ORDERING EXAMPLE

**SS12SDP2LC**

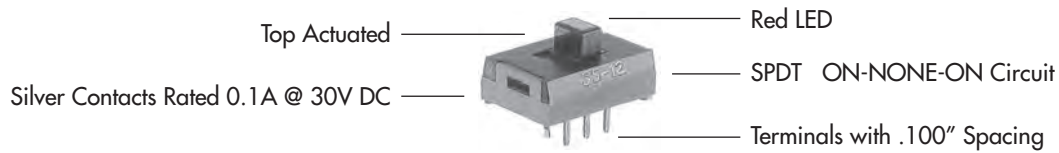

POLES & CIRCUITS

Pole	Model	Slide Position			Connected Terminals			Throw & Schematics
		Right	Center	Left	Right	Center	Left	
SP	SS12S	ON	NONE	ON	2-1	NONE	2-3	SPDT
DP	SS22S	ON	NONE	ON	2-1 5-4	NONE	2-3 5-6	DPDT

Note: Terminal numbers are not actually on switch. Isolated LED circuit requires external power source.

TERMINAL SPACING

**D** Inch .100" x .100"

Single Pole Models

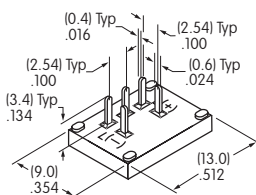

Double Pole Models

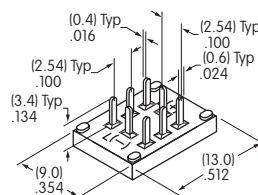

## CONTACT MATERIALS & RATINGS

2

Silver over Phosphor Bronze

Power Level

0.1A @ 30V DC

## TYPICAL SWITCH DIMENSIONS

### Top Actuated

### Single & Double Pole

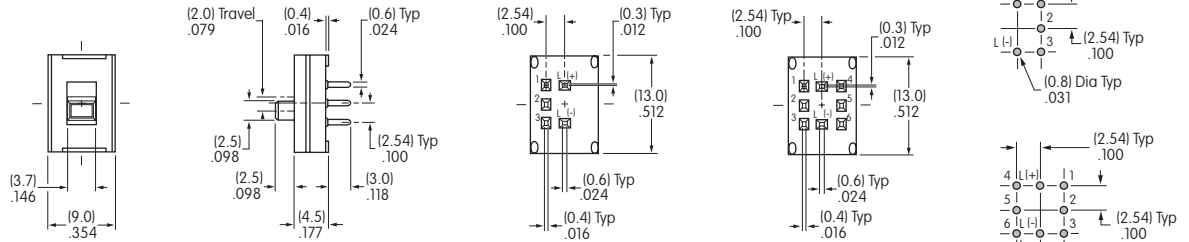

SS22SDP2LC

### Side Actuated

### Single & Double Pole

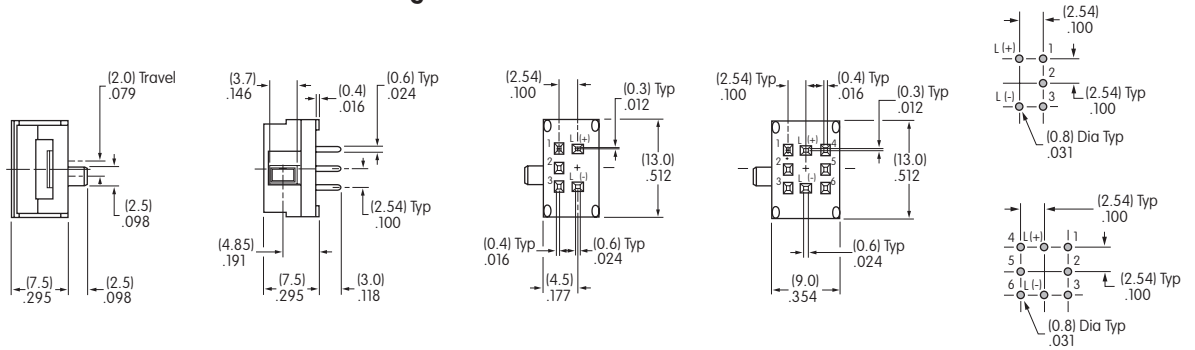

SS12SDH2LC

## LED COLORS & SPECIFICATIONS

LEDs are supplied as an integral part of the switch (not available separately). The lamp circuit is independent of switch operation. Electrical specifications shown are determined at a basic temperature of 25°C.

If the source voltage exceeds the rated voltage, a ballast resistor is required. The resistor value can be calculated by using the formula given in the Supplement.

L Isolated, 1-element	Color	C	E	F
		Red	Yellow	Green
Maximum Forward Current	$I_{FM}$	30mA	30mA	25mA
Typical Forward Current	$I_F$	16mA	16mA	16mA
Forward Voltage	$V_F$	1.98V	2.06V	2.16V
Maximum Reverse Voltage	$V_{RM}$	5V	5V	5V
Current Reduction Rate Above 25°C	$\Delta I_F$	0.40mA/°C	0.42mA/°C	0.33mA/°C
Ambient Temperature Range		-15° ~ +60°C		

## OPTIONAL CAP

### AT4065 Slide Cap

Material: Polycarbonate

Cap can be assembled on request

Cap Color: Black only

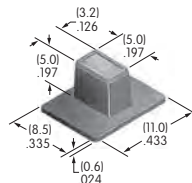

Window color should match LED color.

Colors Available:

C Red    E Yellow    F Green

# Distinctive Characteristics

Compact dimensions and low profile allow high density mounting and close stacking of PC boards.

Crisp actuation positively indicates circuit status.

Heat resistant resin allows vapor phase and infrared convection reflow soldering.

Award-winning STC mechanism with benefits unavailable in conventional mechanisms: smoother, positive detent actuation, increased contact stability, and unparalleled logic-level reliability. (Additional STC details in Terms and Acronyms in the Supplement section.)

Insert molded terminals lock out flux, solvents, and other contaminants.

Metric terminal spacing for standard PC board grid (2.0mm x 2.0mm ).

Gull-wing terminals provide mechanical stability during soldering and simplified solder joint inspection.

Packaged in tape-reel or partitioned tray. Tape-reel packaging meets EIA-481-D Standard.

Coplanarity: all considered surfaces must lie between two parallel planes that are a maximum distance apart of .0059" (0.15mm). (Additional coplanarity details in Terms and Acronyms in the Supplement section.)

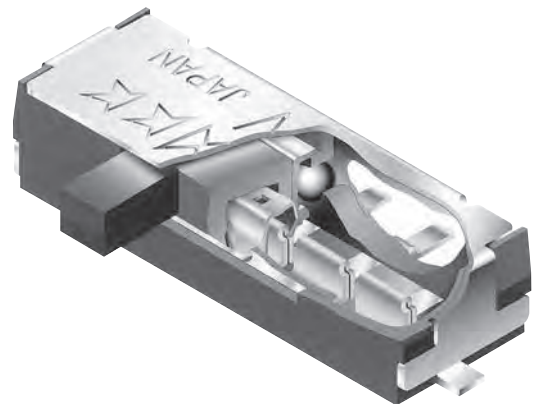

Actual Size

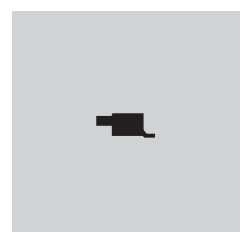

# General Specifications

Toggles

Rockers

Pushbuttons

Illuminated PB

Programmable

Keylocks

Rotaries

Slides

Tactiles

Tilt

Touch

Indicators

Accessories

Supplement

## Electrical Capacity (Resistive Load)

**Logic Level:** 0.4VA maximum @ 28V AC/DC maximum  
(Applicable Range 0.1mA ~ 0.1A @ 20mV ~ 28V)  
Note: Find additional explanation of operating range in Supplement section.

## Other Ratings

**Contact Resistance:** 50 milliohms maximum  
**Insulation Resistance:** 100 megohms minimum @ 500V DC  
**Dielectric Strength:** 500V AC minimum for 1 minute minimum  
**Mechanical Life:** 10,000 operations minimum  
**Electrical Life:** 10,000 operations minimum  
**Contact Timing:** SS312S ~ Shorting (make-before-break)  
**Total Travel:** .079" (2.0mm)

## Materials & Finishes

**Actuator:** Polyphenylene sulfide  
**Housing:** Phosphor bronze with tin plating (UL94V-0)  
**Base:** Polyphenylene sulfide (UL94V-0)  
**Movable Contactor:** Phosphor bronze with gold plating over silver plating (code 4)  
**Terminals:** Phosphor bronze with gold plating

## Environmental Data

**Operating Temp Range:** -25°C through +85°C (-13°F through +185°F)  
**Humidity:** 90 ~ 95% humidity for 240 hours @ 40°C (104°F)  
**Vibration:** 10 ~ 55Hz with peak-to-peak amplitude of 1.5mm traversing the frequency range & returning in 1 minute; 3 right angled directions for 2 hours  
**Shock:** 50G (490m/s<sup>2</sup>) acceleration (tested in 6 right angled directions, with 5 shocks in each direction)

## Installation

**Soldering:** Reflow Soldering Recommended. See Profile A in Supplement section.  
Manual Soldering: See Profile A in Supplement section.  
**Cleaning:** These devices are not process sealed. Hand clean locally using alcohol based solution.

## Standards & Certifications

**Flammability Standards:** UL 94V-0 rated housing & base  
The SS3 Series slides have not been tested for UL recognition or CSA certification.  
These switches are designed for use in a low-voltage, low-current, logic-level circuit.  
When used as intended in a logic-level circuit, the results do not produce hazardous energy.



TYPICAL SWITCH ORDERING EXAMPLE

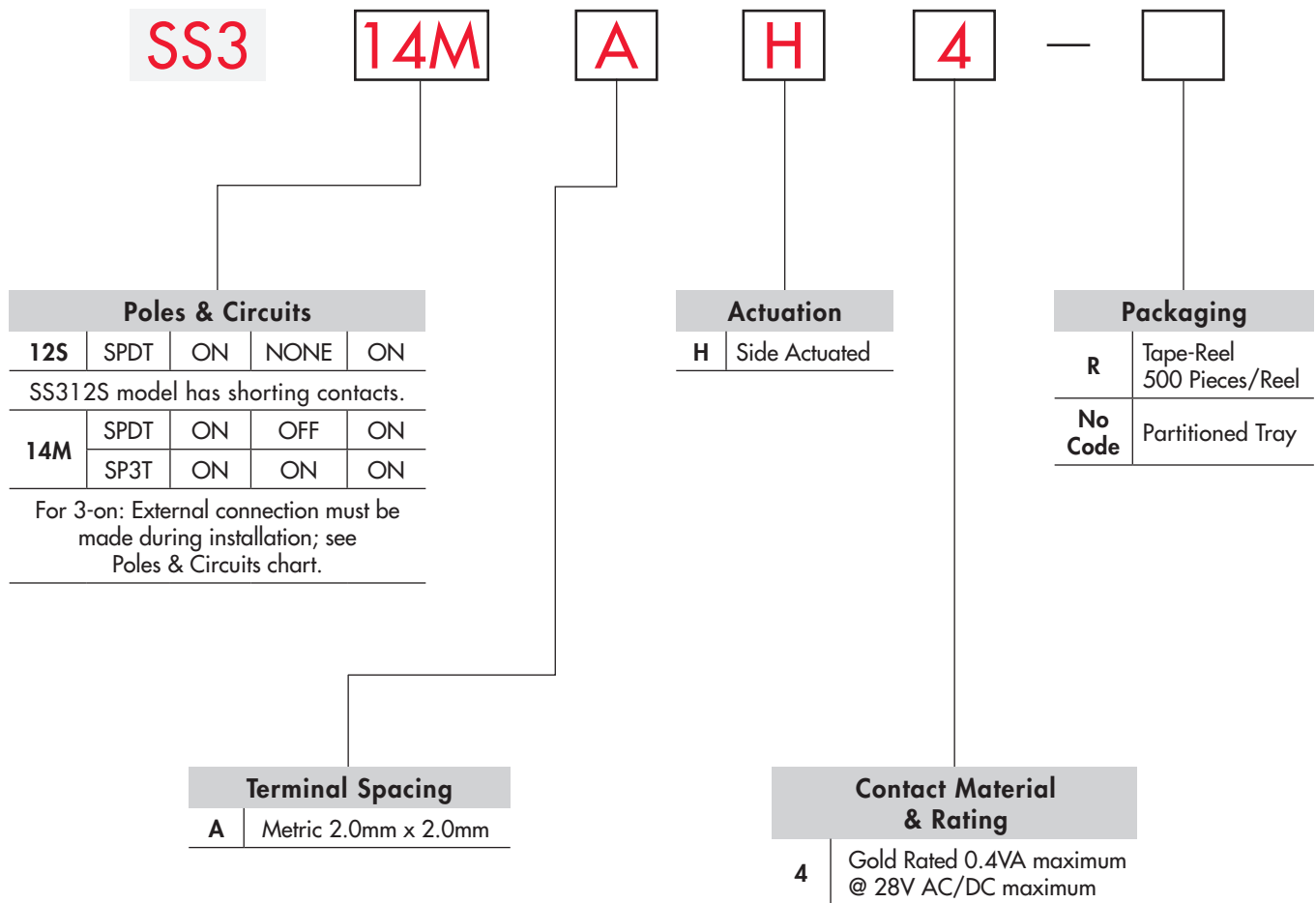

DESCRIPTION FOR TYPICAL ORDERING EXAMPLE

SS314MAH4



Toggles

Rockers

Pushbuttons

Illuminated PB

Programmable

Keylocks

Rotaries

Slides

Tactiles

Tilt

Touch

Indicators

Accessories

Supplement

## POLES & CIRCUITS

		Slide Position			Connected Terminals			Throw & Schematics	
Pole	Model	Right	Center	Left	Right	Center	Left	Note: Terminal numbers are not actually on switch.	
SP	SS312S							SPDT	
SP	SS314M							SPDT	
								SP3T	 External Connection External connection must be made during installation to create ON-ON-ON circuit.

## TERMINAL SPACING

**A** Metric 2.0mm x 2.0mm

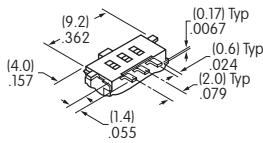

SS312

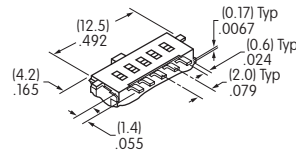
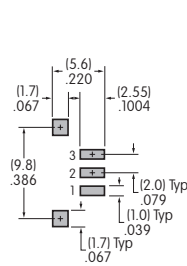

SS314

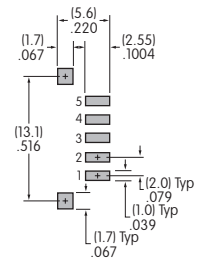

## ACTUATION

**H** Side Actuated

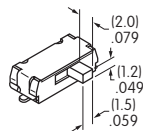

## CONTACT MATERIALS & RATING

**4** Gold over Silver/Phosphor Bronze      Logic Level      0.4VA maximum @ 28V AC/DC maximum

Complete explanation of operating range in Supplement section.

TYPICAL SWITCH DIMENSIONS

Shorting Contacts

Single Pole

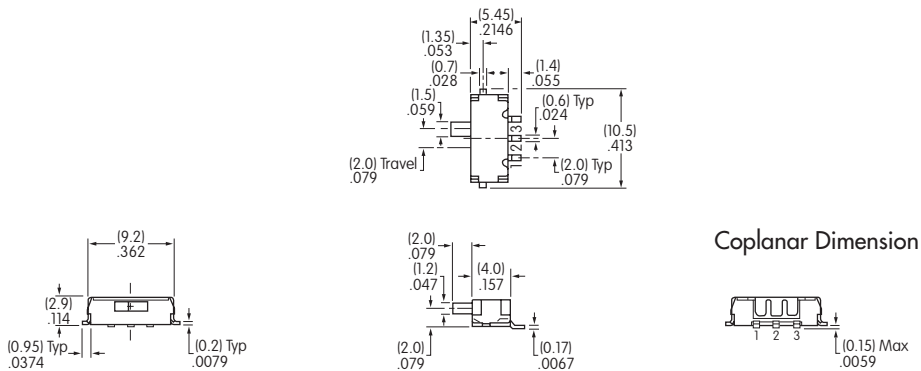

SS312SAH4

Nonshorting Contacts

Single Pole

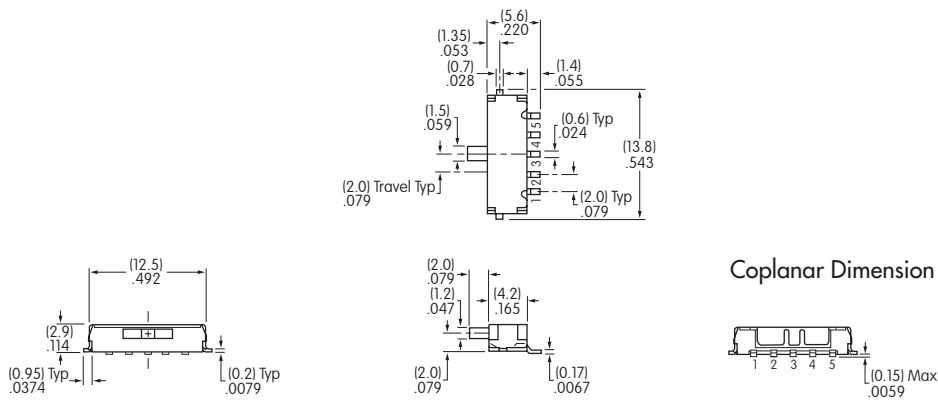

SS314MAH4

PACKAGING

No Code

Partitioned Tray

If the SS3 is ordered in less than 500-piece increments, the switches are packaged in a partitioned tray. No code is required.



## PACKAGING

**R**

### Tape-Reel Packaging

Switches must be ordered in 500-piece increments when tape-reel packaging is selected.

Tape-reel packaging meets EIA-481-D Standard.

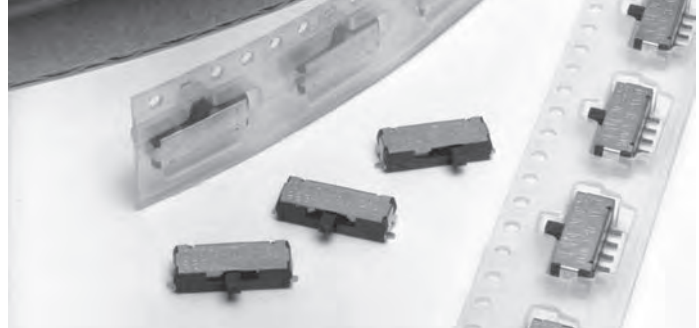

### Tape-Reel Packaging for SS312SAH4

Each tape-reel of 530 pockets contains 500 switches.

Minimum Leader Length: 11.97" (304mm) Minimum Trailer Length: 6.93" (176mm)

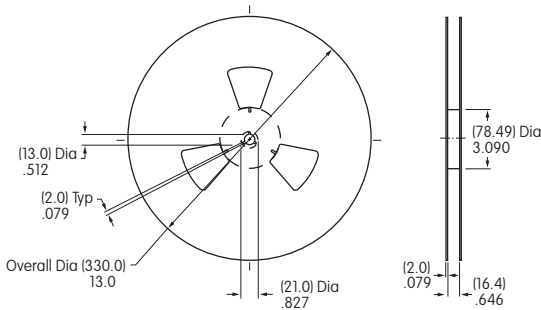

Reel Dimensions

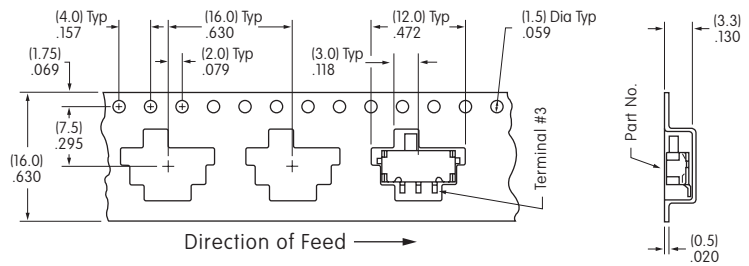

Tape Dimensions

### Tape-Reel Packaging for SS314MAH4

Each tape-reel of 530 pockets contains 500 switches.

Minimum Leader Length: 14.96" (380mm) Minimum Trailer Length: 8.66" (220mm)

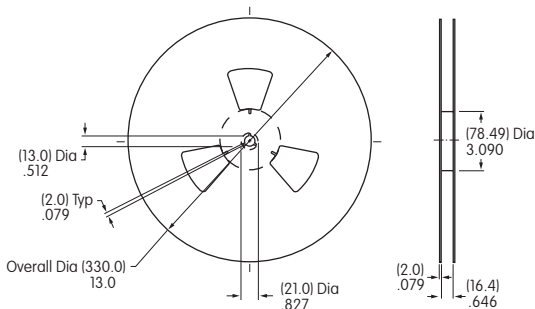

Reel Dimensions

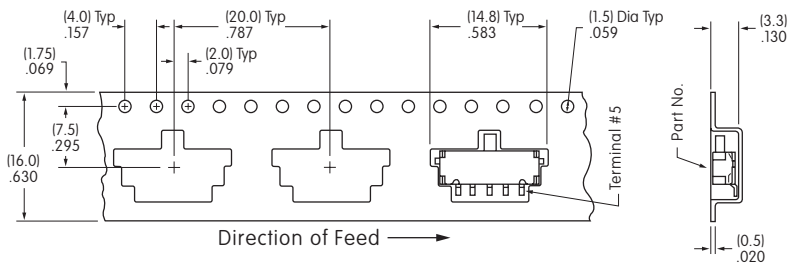

Tape Dimensions

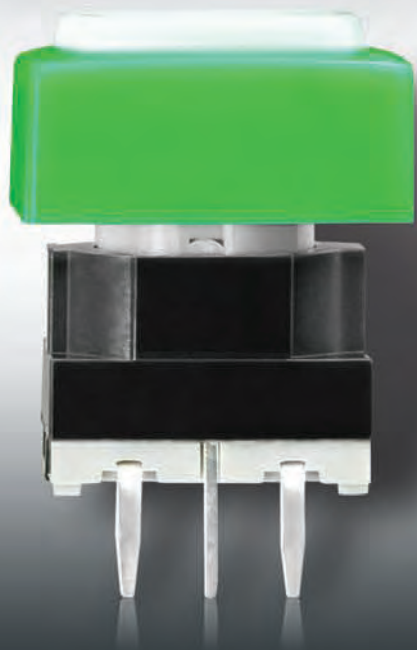

Toggles

Rockers

Pushbuttons

Illuminated PB

Programmable

Keylocks

Rotaries

Slides

Tactiles

Tilt

Touch

Indicators

Accessories

Supplement

## CB Series .....J4



6mm Process Sealed  
50mA Low/Logic Level  
Straight PC  
PCB Mount  
Flat Button

## CB3 Series .....J8



6mm SMT  
Process Sealed  
50mA Low/Logic Level  
Gull Wing Terminals  
Upright Mount  
Flat Button

## HP02 Series .....J12



6mm  
3VA DC Power Level or 0.4VA Logic Level  
Straight PC  
PCB Mount

## HP03 Series .....J16



6mm SMT  
3VA DC Power Level & 0.4VA Logic Level  
Gull Wing Terminals  
Upright Mount



**JB Series .....J20**

10mm Process Sealed  
 50mA or 125mA Low/Logic Level  
 Straight or Right Angle PC  
 PCB Mount



**JB Illuminated Series .....J28**

Low Profile  
 50mA or 125mA Low/Logic Level  
 Process Sealed  
 Straight PC



**JF Series .....J34**

Ultra-Thin  
 50mA Low/Logic Level  
 Straight PC  
 PCB Mount



**JF Illuminated Series .....J40**

Ultra-thin  
 50mA Low/Logic Level  
 Process Sealed  
 Straight PC



**JL Illuminated Series .....J46**

Ultra-thin  
 19mm Full Face  
 50mA Low/Logic Level  
 Straight PC

Toggles

Rockers

Pushbuttons

Illuminated PB

Programmable

Key locks

Rotaries

Slides

**J**  
Tactiles

Tilt

Touch

Indicators

Accessories

Supplement

# General Specifications

## Electrical Capacity (Resistive Load)

**Low/Logic Level:** 50mA @ 24V DC maximum

## Other Ratings

**Contact Resistance:** 100 milliohms maximum

**Insulation Resistance:** 100 megohms minimum @ 250V DC

**Dielectric Strength:** 250V AC minimum between contacts & between contacts & case for 1 minute minimum

**Mechanical Life:** 100,000 operations minimum

**Electrical Life:** 100,000 operations minimum

**Nominal Operating Force:** 1.57N

**Total Travel:** .010" (.250mm)

## Materials & Finishes

**Actuator:** Glass fiber reinforced polyamide (UL94V-0)

**Case:** Stainless steel

**Seal:** Polytetrafluoroethylene

**Base:** Polyphthalamide (UL94V-0)

**Movable Contacts:** Beryllium copper with silver plating

**Stationary Contacts:** Brass with silver plating

**Terminals:** Brass with silver plating

## Environmental Data

**Operating Temperature Range:** -25°C through +70°C (-13°F through +158°F)

**Humidity:** 90 ~ 95% humidity for 96 hours @ 40°C (104°F)

**Vibration:** 10 ~ 55Hz with peak-to-peak amplitude of 1.5mm traversing the frequency range & returning in 1 minute; 3 right angled directions for 2 hours

**Shock:** 50G (490m/s<sup>2</sup>) acceleration (tested in 6 right angled directions, with 5 shocks in each direction)

## PCB Processing

**Soldering:** Wave Soldering Recommended. See Profile A in Supplement section.

Manual Soldering: See Profile A in Supplement section.

**Cleaning:** Automated cleaning. See Cleaning specifications in Supplement section.

## Standards & Certifications

**Flammability Standards:** UL94V-0 actuator & base

The CB Series tactiles have not been tested for UL recognition or CSA certification.

These switches are designed for use in a low-voltage, low-current, logic-level circuit.

When used as intended in a logic-level circuit, the results do not produce hazardous energy.



# Distinctive Characteristics

Sealed construction prevents contact contamination and allows automated soldering and cleaning.

.244" (6.2mm) square body allows compact mounting.

Actuator and base meet UL flammability rating of 94V-0.

Dome contact gives crisp tactile feedback to positively indicate circuit transfer and assures high reliability and long life – more than 100,000 operations.

Crimped terminals ensure secure mounting and prevent dislodging during wave soldering.

Insert molded terminals lock out flux, solvents, and other contaminants.

Packaged in stick tube or partitioned tray.

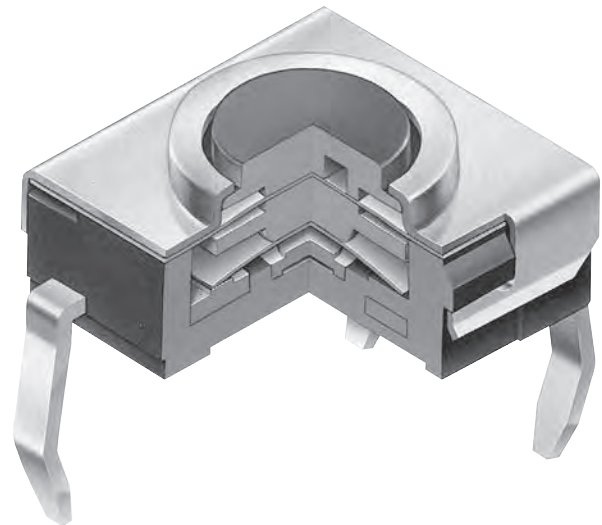

Actual Size

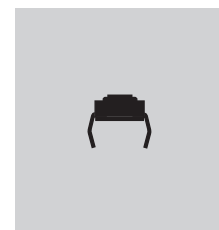

### TYPICAL SWITCH ORDERING EXAMPLE

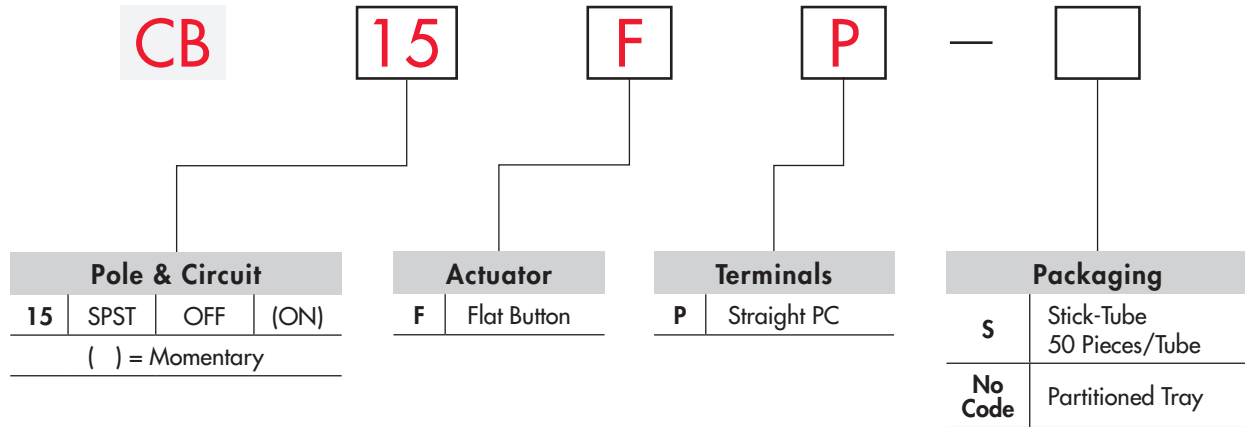

### DESCRIPTION FOR TYPICAL ORDERING EXAMPLE

**CB15FP**



### POLE & CIRCUIT

Pole	Model	Actuator Position ( ) = Momentary		Switch Throw & Schematic	Note: Terminal numbers are not actually on the switch.
		Normal	Down		
SP	CB15	OFF	(ON)	SPST	

### TYPICAL SWITCH DIMENSIONS

#### Single Pole • Single Throw

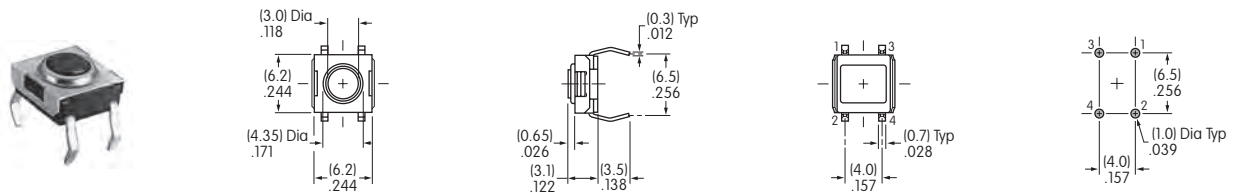

**CB15FP**

PACKAGING

**S** Stick-Tube

Switches must be ordered in 50-piece increments when stick-tube packaging is selected.

**No Code** Partitioned Tray

If ordered in less than 50-piece increments, the switches are packaged in a partitioned tray.



Stick-Tube Dimensions

Each stick-tube contains 50 switches

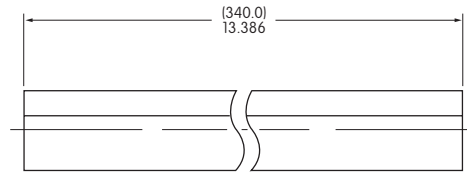
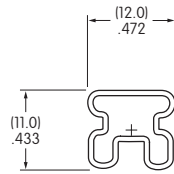

KEYBOARD MATRIX

Common Bus Matrix

These single pole, single throw switches can be used in a keyboard matrix and, using strapped terminals, achieve a common bus electrical configuration on a single-sided PC board.

X-Y Matrix

These single pole, single throw switches can be arranged on a single-sided PC board matrix with strapped terminals to achieve an X-Y type electrical interconnection.

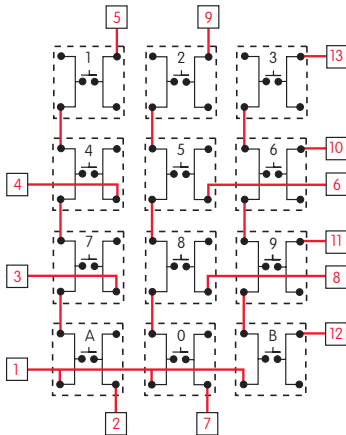

		PC Terminations												
		1	2	3	4	5	6	7	8	9	10	11	12	13
1	●													
2														
3														
4														
5														
6														
7														
8														
9														
0														
A														
B														

● = ON

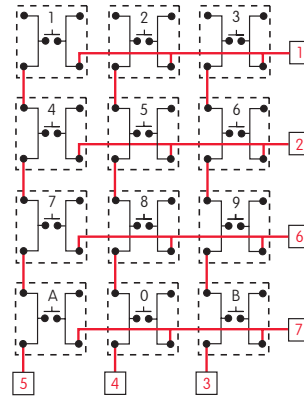

		PC Terminations						
		1	2	3	4	5	6	7
1	●							
2								
3								
4								
5								
6								
7								
8								
9								
0								
A								
B								

● = ON

Red = PCB Trace    Black = Switch Circuit

# General Specifications

## Electrical Capacity (Resistive Load)

**Low/Logic Level:** 50mA @ 24V DC maximum

## Other Ratings

**Contact Resistance:** 100 milliohms maximum

**Insulation Resistance:** 100 megohms minimum @ 250V DC

**Dielectric Strength:** 250V AC minimum between contacts & between contacts & case for 1 minute minimum

**Mechanical Life:** 100,000 operations minimum

**Electrical Life:** 100,000 operations minimum

**Nominal Operating Force:** 1.57N

**Total Travel:** .010" (.250mm)

## Materials & Finishes

**Actuator:** Glass fiber reinforced polyamide (UL94V-0)

**Case:** Stainless steel

**Seal:** Polytetrafluoroethylene

**Base:** Polyphthalamide (UL94V-0)

**Movable Contacts:** Beryllium copper with silver plating

**Stationary Contacts:** Brass with silver plating

**Terminals:** Brass with silver plating

## Environmental Data

**Operating Temperature Range:** -25°C through +70°C (-13°F through +158°F)

**Humidity:** 90 ~ 95% humidity for 96 hours @ 40°C (104°F)

**Vibration:** 10 ~ 55Hz with peak-to-peak amplitude of 1.5mm traversing the frequency range & returning in 1 minute; 3 right angled directions for 2 hours

**Shock:** 50G (490m/s<sup>2</sup>) acceleration (tested in 6 right angled directions, with 5 shocks in each direction)

## Processing

**Soldering:** Reflow Soldering Recommended. See Profile A in Supplement section.

Manual Soldering: See Profile A in Supplement section.

**Cleaning:** Automated cleaning. See Cleaning Specifications in Supplement section.

## Standards & Certifications

**Flammability Standards:** UL94V-0 actuator & base

The CB3 Series tactiles have not been tested for UL recognition or CSA certification.

These switches are designed for use in a low-voltage, low-current, logic-level circuit.

When used as intended in a logic-level circuit, the results do not produce hazardous energy.

# Distinctive Characteristics

Sealed construction prevents contact contamination and allows automated soldering and cleaning.

.244" (6.2mm) square body allows compact mounting.

Heat tolerant resin used for actuator and base meets UL flammability rating of 94V-0 and maintains switch reliability through vapor phase and infrared convection reflow soldering.

Dome contact gives crisp tactile feedback to positively indicate circuit transfer and assures high reliability and long life – more than 100,000 operations.

Gull-winged terminals ensure mechanical stability during soldering and simplify solder joint inspection.

Insert molded terminals lock out flux, solvents, and other contaminants.

Packaged in tape-reel or partitioned tray. Tape-reel packaging meets EIA-481-D Standard.

Coplanarity: all considered surfaces must lie between two parallel planes that are a maximum distance apart of .0059" (0.15mm). (Additional coplanarity details in Terms and Acronyms in the Supplement section.)

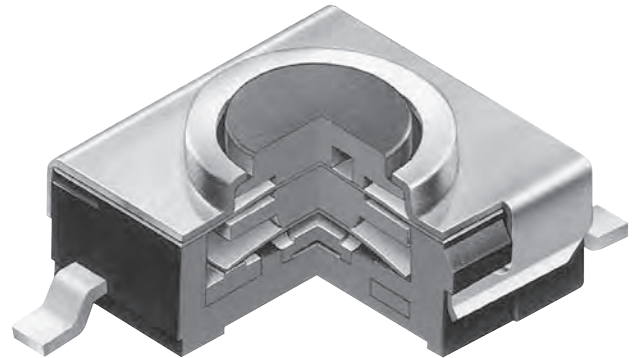

Actual Size



### TYPICAL SWITCH ORDERING EXAMPLE

<b>CB3</b>	<b>15</b>	<b>F</b>	<b>P</b>	—	
<b>Pole &amp; Circuit</b>		<b>Actuator</b>		<b>Terminals</b>	
<b>15</b>	SPST OFF (ON)	<b>F</b>	Flat Button	<b>P</b>	Gull Wing for Upright Mount
( ) = Momentary					
<b>Packaging</b>					
<b>R</b>	Tape-Reel 1,000 Pieces/Reel				
<b>No Code</b>	Partitioned Tray				

### DESCRIPTION FOR TYPICAL ORDERING EXAMPLE

#### CB315FP

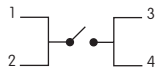

### POLE & CIRCUIT

Pole	Model	Actuator Position ( ) = Momentary		Switch Throw & Schematic	Note: Terminal numbers are not actually on switch.
		Normal	Down		
SP	CB315	OFF	(ON)		

### TYPICAL SWITCH DIMENSIONS

#### Single Pole • Single Throw

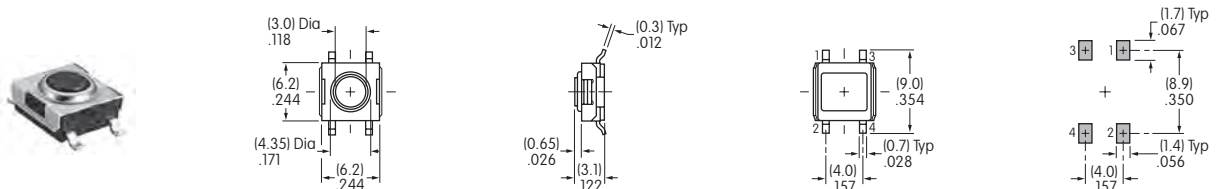

CB315FP

Toggles  
 Rockers  
 Pushbuttons  
 Illuminated PB  
 Programmable  
 Keylocks  
 Rotaries  
 Slides  
 Tactiles  
 Tilt  
 Touch  
 Indicators  
 Accessories  
 Supplement

## PACKAGING

**R**

**Tape-Reel** (packaged to EIA-481-D standard)

Switches must be ordered in 1,000-piece increments when tape-reel packaging is selected.

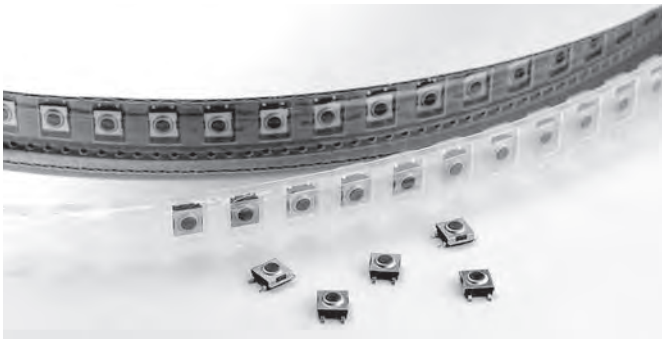

**No Code**

**Partitioned Tray**

If less than 1,000 pieces are ordered, the switches are packaged in a partitioned tray. No code is required.

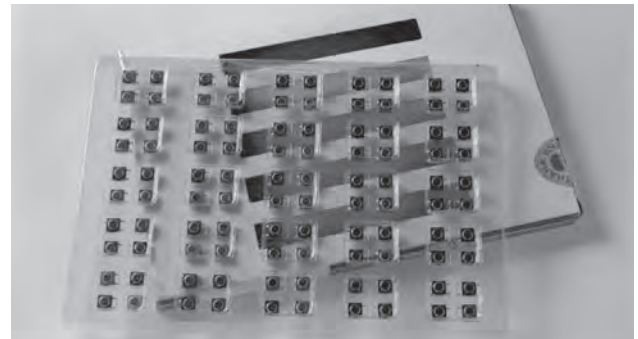

### Tape-Reel Dimensions & Specifications

Each tape-reel of 1,050 pockets contains 1,000 switches

Minimum Leader Length: 16.54" (420mm) Minimum Trailer Length: 7.09" (180mm)

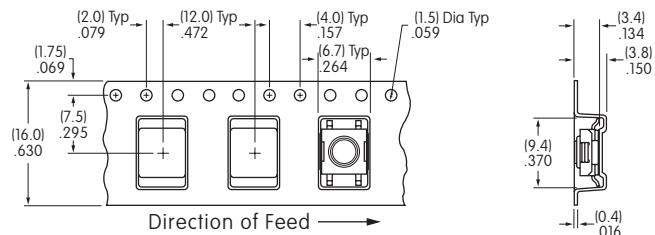
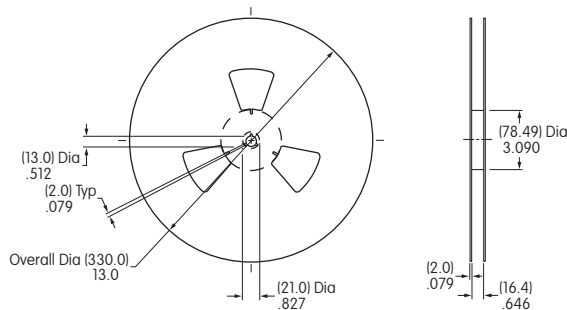

## KEYBOARD MATRIX

### Common Bus Matrix

These single pole, single throw switches can be used in a keyboard matrix and, using strapped terminals, achieve a common bus electrical configuration on a single-sided PC board.

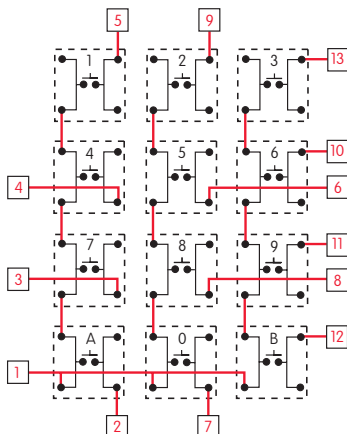

		PC Terminations												
		1	2	3	4	5	6	7	8	9	10	11	12	13
Keys (Switches)	1													
	2													
	3													
	4													
	5													
	6													
	7													
	8													
	9													
	0													
	A													
	B													

Red = PCB Trace Black = Switch Circuit

### X-Y Matrix

These single pole, single throw switches can be arranged on a single-sided PC board matrix with strapped terminals to achieve an X-Y type electrical interconnection.

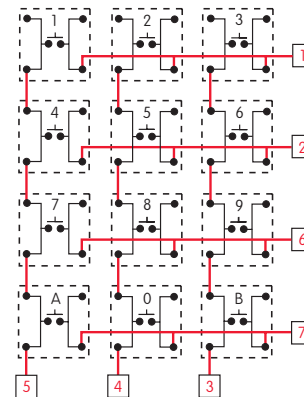

		PC Terminations						
		1	2	3	4	5	6	7
Keys (Switches)	1							
	2							
	3							
	4							
	5							
	6							
	7							
	0							
	A							
	B							

Toggles  
Rockers  
Pushbuttons  
Illuminated PB  
Programmable  
Key locks  
Rotaries  
Slides  
Tactiles  
Tilt  
Touch  
Indicators  
Accessories  
Supplement

# General Specifications

## Electrical Capacity (Resistive Load)

<b>Power Level (silver):</b>	3VA maximum @ 28V DC maximum (Applicable Range 10mA ~ 125mA @ 0.1V ~ 28V)
<b>Logic Level (gold):</b>	0.4VA maximum @ 28V AC/DC maximum (Applicable Range 0.1mA ~ 0.1A @ 20mV ~ 28V)
	Note: See Supplement for further explanation of operating range.

## Other Ratings

<b>Contact Resistance:</b>	100 milliohms maximum
<b>Insulation Resistance:</b>	100 megohms minimum @ 100V DC
<b>Dielectric Strength:</b>	250V AC minimum for 1 minute minimum between contacts & between contacts & case
<b>Mechanical Life:</b>	500,000 operations minimum
<b>Electrical Life:</b>	500,000 operations minimum
<b>Nominal Operating Force:</b>	1.60N
<b>Total Travel:</b>	.008" (0.2mm)

## Materials & Finishes

<b>Actuator:</b>	Glass fiber reinforced polyamide (UL94V-0)
<b>Case:</b>	Stainless steel
<b>Base:</b>	Glass fiber reinforced polyamide (UL94V-0)
<b>Movable Contacts:</b>	Stainless steel with silver or gold plating
<b>Stationary Contacts:</b>	Brass with silver or gold plating
<b>Terminals:</b>	Brass with silver or gold plating

## Environmental Data

<b>Operating Temperature Range:</b>	-20°C through +70°C (-4°F through +158°F)
<b>Humidity:</b>	90 ~ 95% humidity for 240 hours @ 40°C (104°F)
<b>Vibration:</b>	10 ~ 55Hz with peak-to-peak amplitude of 1.5mm traversing the frequency range & returning in 1 minute; 3 right angled directions for 2 hours
<b>Shock:</b>	100G (981m/s <sup>2</sup> ) acceleration (tested in 6 right angled directions, with 5 shocks in each direction)

## PCB Processing

<b>Soldering:</b>	Wave Soldering Recommended. See Profile A in Supplement section. Manual Soldering: See Profile A in Supplement section.
<b>Cleaning:</b>	These devices are not process sealed. Hand clean locally using alcohol based solution.

## Standards & Certifications

<b>Flammability Standards:</b>	UL94V-0 actuator and base These switches are designed for use in a low-voltage, low-current circuit. When used as intended, the results do not produce hazardous energy.
--------------------------------	--



# Distinctive Characteristics

.244" (6.2mm) square body allows compact mounting.

Heat resistant resin body meets lead-free solder processing requirements and UL flammability rating of 94V-0.

Stick-tube packaging allows rapid automated placement of devices.

Gold plated contacts available for very low voltage/current applications offer advantages of little or no oxidization or sulfurization and stable contact resistance.

Crimped terminals provide a spring type action which ensures secure mounting and prevents dislodging during automated soldering.

Insert molded terminals lock out flux, solvents, and other contaminants and allow automated soldering.

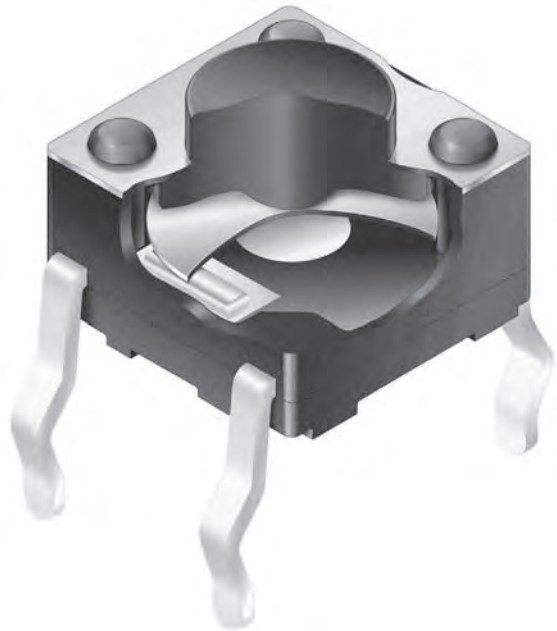

Actual Size

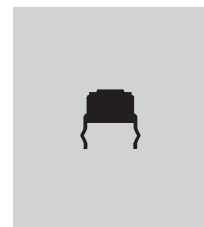

### TYPICAL SWITCH ORDERING EXAMPLE

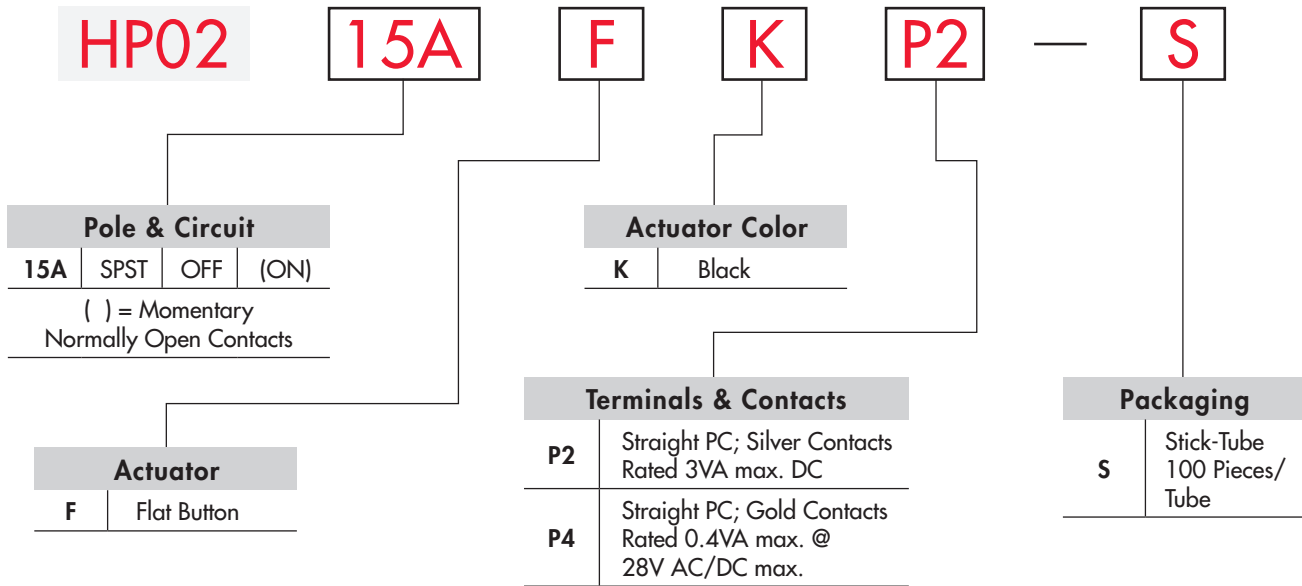

### DESCRIPTION FOR TYPICAL ORDERING EXAMPLE

#### HP0215AFKP2-S

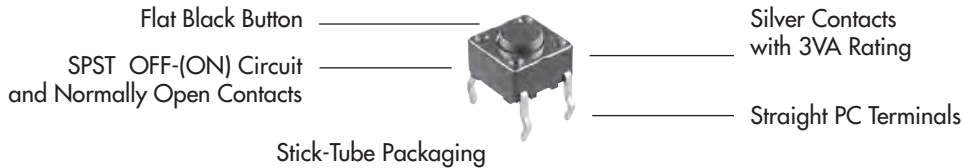

### POLE & CIRCUIT

		Actuator Position ( ) = Momentary		Switch Throw & Schematic	Note: Terminal numbers are not actually on the switch.
Pole	Model	Normal	Down		
SP	HP0215A	OFF	(ON)	SPST	

### TYPICAL SWITCH DIMENSIONS

#### Straight PC



HP0215AFKP2

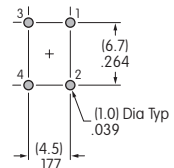
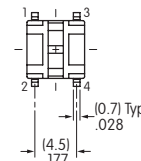
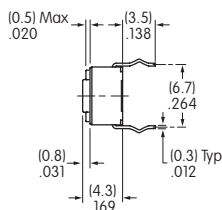
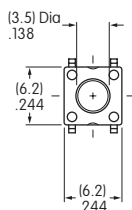

PACKAGING

S

Stick-Tube

Switches must be ordered in 100-piece increments.

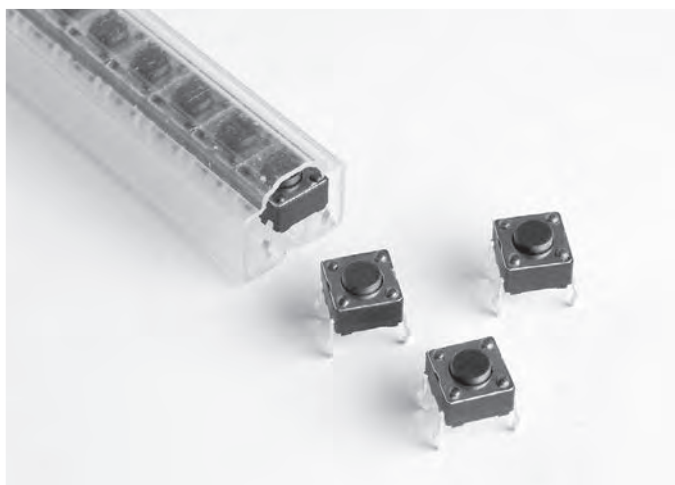

Stick-Tube Dimensions

Each stick-tube contains 100 switches.

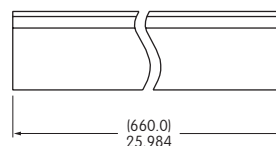
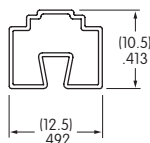

KEYBOARD MATRIX

Common Bus Matrix

These single pole, single throw switches can be used in a keyboard matrix and, using strapped terminals, achieve a common bus electrical configuration on a single-sided PC board.

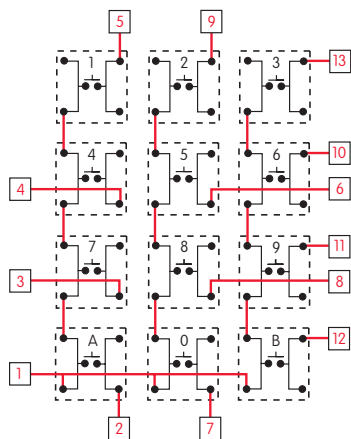

		PC Terminations												
		1	2	3	4	5	6	7	8	9	10	11	12	13
Keys (Switches)	1													
	2													
	3													
	4													
	5													
	6													
	7													
	8													
	9													
	0													
	A													
	B													

● = ON

X-Y Matrix

These single pole, single throw switches can be arranged on a single-sided PC board matrix with strapped terminals to achieve an X-Y type electrical interconnection.

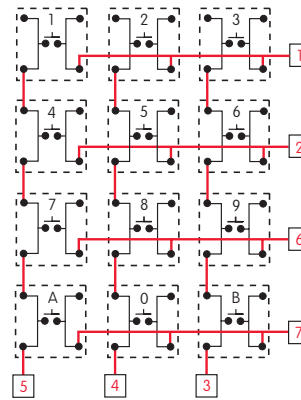

		PC Terminations						
		1	2	3	4	5	6	7
Keys (Switches)	1							
	2							
	3							
	4							
	5							
	6							
	7							
	8							
	9							
	0							
	A							
	B							

● = ON

Red = PCB Trace    Black = Switch Circuit

Toggles  
Rocker  
Pushbuttons  
Illuminated PB  
Programmable  
Key locks  
Rotaries  
Slides  
Tactiles  
Tilt  
Touch  
Indicators  
Accessories  
Supplement

# General Specifications

## Electrical Capacity (Resistive Load)

<b>Power Level (silver):</b>	3VA maximum @ 28V DC maximum (Applicable Range 10mA ~ 125mA @ 0.1V ~ 28V)
<b>Logic Level (gold):</b>	0.4VA maximum @ 28V AC/DC maximum (Applicable Range 0.1mA ~ 0.1A @ 20mV ~ 28V)
	Note: See Supplement for further explanation of operating range.

## Other Ratings

<b>Contact Resistance:</b>	100 milliohms maximum
<b>Insulation Resistance:</b>	100 megohms minimum @ 100V DC
<b>Dielectric Strength:</b>	250V AC minimum for 1 minute minimum between contacts & between contacts & case
<b>Mechanical Life:</b>	500,000 operations minimum
<b>Electrical Life:</b>	500,000 operations minimum
<b>Nominal Operating Force:</b>	1.60N
<b>Total Travel:</b>	.008" (0.2mm)

## Materials & Finishes

<b>Actuator:</b>	Glass fiber reinforced polyamide (UL94V-0)
<b>Case:</b>	Stainless steel
<b>Base:</b>	Glass fiber reinforced polyamide (UL94V-0)
<b>Movable Contacts:</b>	Stainless steel with silver or gold plating
<b>Stationary Contacts:</b>	Brass with silver or gold plating
<b>Terminals:</b>	Brass with silver or gold plating

## Environmental Data

<b>Operating Temperature Range:</b>	-20°C through +70°C (-4°F through +158°F)
<b>Humidity:</b>	90 ~ 95% humidity for 240 hours @ 40°C (104°F)
<b>Vibration:</b>	10 ~ 55Hz with peak-to-peak amplitude of 1.5mm traversing the frequency range & returning in 1 minute; 3 right angled directions for 2 hours
<b>Shock:</b>	100G (981m/s <sup>2</sup> ) acceleration (tested in 6 right angled directions, with 5 shocks in each direction)

## Processing

<b>Soldering:</b>	Reflow Soldering Recommended. See Profile A in Supplement section. Manual Soldering: See Profile A in Supplement section.
<b>Cleaning:</b>	These devices are not process sealed. Hand clean locally using alcohol based solution.

## Standards & Certifications

<b>Flammability Standards:</b>	UL94V-0 actuator and base These switches are designed for use in a low-voltage, low-current circuit. When used as intended, the results do not produce hazardous energy.
--------------------------------	--

# Distinctive Characteristics

.244" (6.2mm) square body allows compact mounting.

Heat resistant resin body meets lead-free solder processing requirements and UL flammability rating of 94V-0.

Stick-tube and tape-reel packaging allow rapid automated placement of devices.

Gold plated contacts available for very low voltage/current applications offer advantages of little or no oxidization or sulfurization and stable contact resistance.

Gull-winged terminals ensure mechanical stability during soldering and simplified solder joint inspection.

Insert molded terminals lock out flux, solvents, and other contaminants and allow automated soldering.

Tape-reel packaging meets EIA-481-D Standard.

Coplanarity: all considered surfaces must lie between two parallel planes that are a maximum distance apart of .0039" (0.10mm). (Additional coplanarity details in Terms and Acronyms in the Supplement section.)

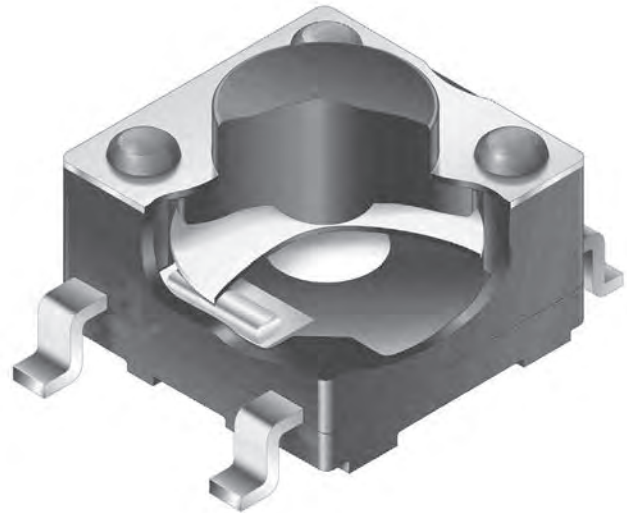

Actual Size

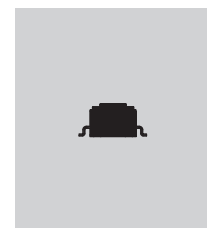

### TYPICAL SWITCH ORDERING EXAMPLE

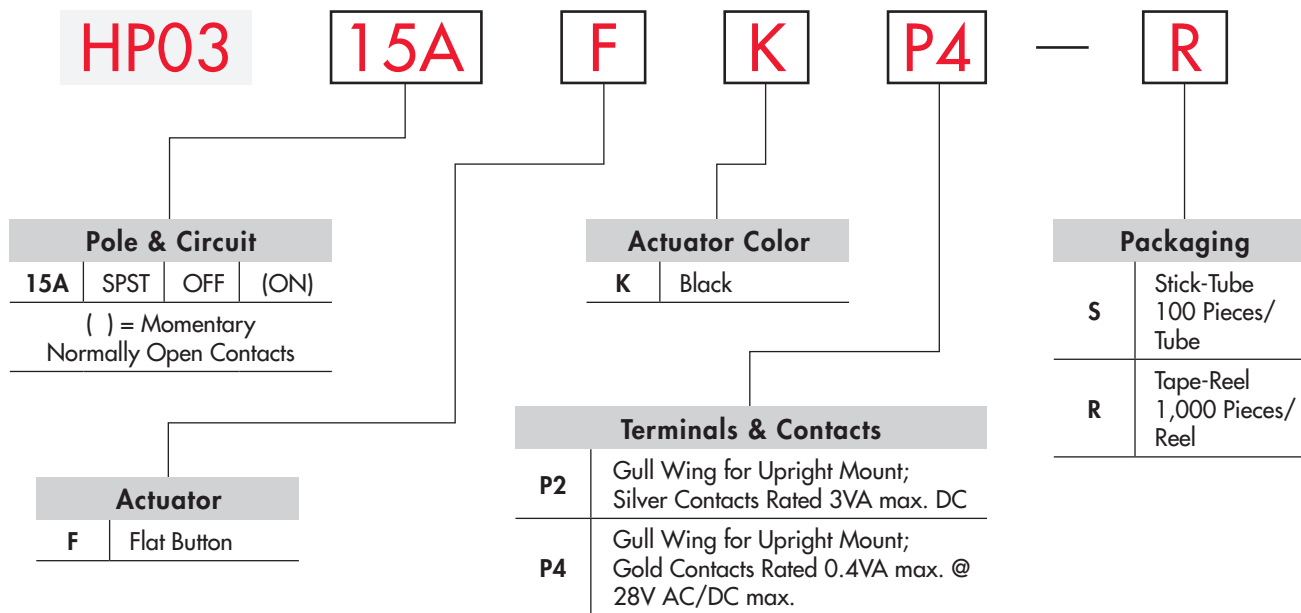

### DESCRIPTION FOR TYPICAL ORDERING EXAMPLE

#### HP0315AFKP4-R

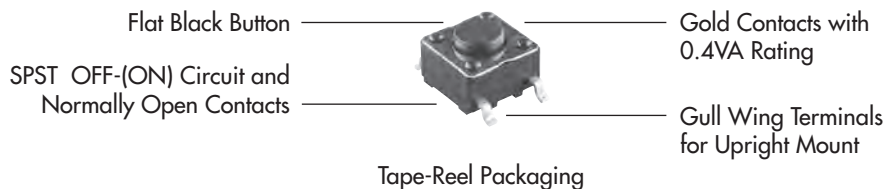

### POLE & CIRCUIT

Pole	Model	Actuator Position ( ) = Momentary		Switch Throw & Schematic	Note: Terminal numbers are not actually on the switch.
		Normal	Down		
SP	HP0315A	OFF	(ON)	SPST	

### TYPICAL SWITCH DIMENSIONS

#### Gull-winged



HP0315AFKP4

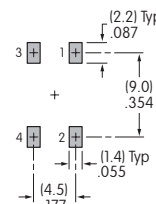
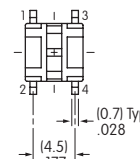
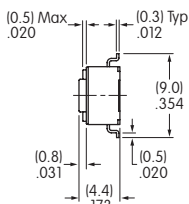
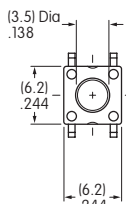

PACKAGING

**S** Stick-Tube

Switches must be ordered in 100-piece increments when stick-tube packaging is selected.



**R** Tape-Reel

Switches must be ordered in 1,000-piece increments when tape-reel packaging is selected.

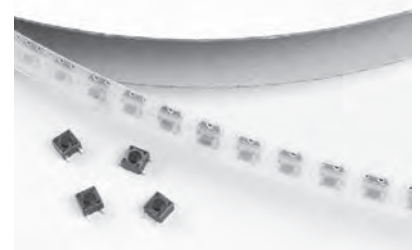

Packaging meets EIA-481-D Standard.

Stick-Tube Dimensions

Each stick-tube contains 100 switches

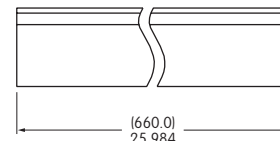
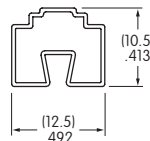

Tape-Reel Dimensions

Each tape-reel of 1,100 pockets contains 1,000 switches.  
Minimum Leader Length: 15.748" (400mm). Minimum Trailer Length: 6.299" (160mm).

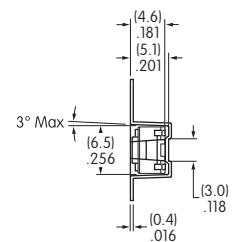
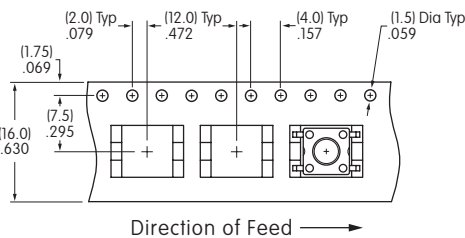
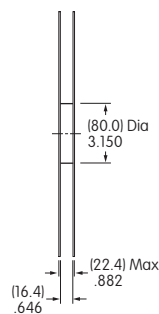
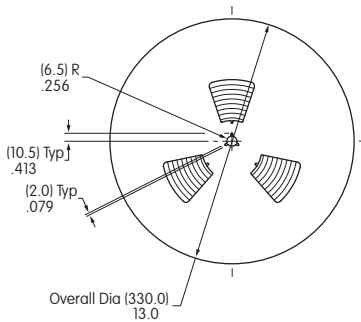

KEYBOARD MATRIX

Common Bus Matrix

These single pole, single throw switches can be used in a keyboard matrix and, using strapped terminals, achieve a common bus electrical configuration on a single-sided PC board.

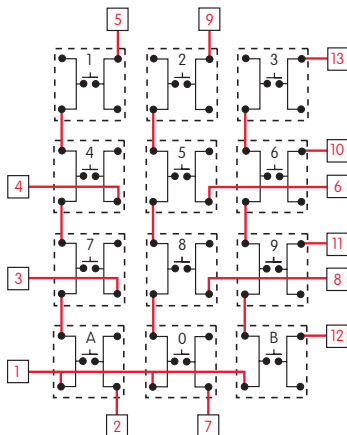

		PC Terminations												
		1	2	3	4	5	6	7	8	9	10	11	12	13
1	●													
2	●													
3	●													
4	●													
5	●													
6	●													
7	●													
8	●													
9	●													
0	●													
A	●													
B	●													

● = ON

Red = PCB Trace Black = Switch Circuit

X-Y Matrix

These single pole, single throw switches can be arranged on a single-sided PC board matrix with strapped terminals to achieve an X-Y type electrical interconnection.

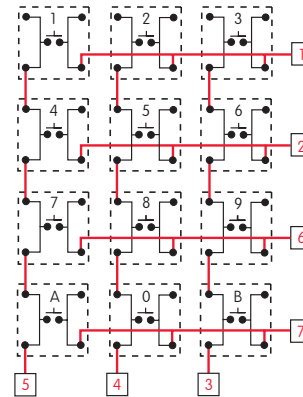

		PC Terminations						
		1	2	3	4	5	6	7
1	●							
2	●							
3	●							
4	●							
5	●							
6	●							
7	●							
8	●							
9	●							
0	●							
A	●							
B	●							

● = ON

# General Specifications

## Electrical Capacity (Resistive Load)

**Low/Logic Level:** 50mA @ 24V DC maximum for Standard Operating Force models  
125mA @ 24V DC maximum for High Operating Force models

## Other Ratings

	Standard Operating Force	High Operating Force
<b>Contact Resistance:</b>	50 milliohms maximum	50 milliohms maximum
<b>Insulation Resistance:</b>	500 megohms minimum @ 250V DC	500 megohms minimum @ 250V DC
<b>Dielectric Strength:</b>	250V AC minimum for 1 minute minimum	250V AC minimum for 1 minute minimum
<b>Mechanical Life:</b>	5,000,000 operations minimum	1,000,000 operations minimum
<b>Electrical Life:</b>	5,000,000 operations minimum	1,000,000 operations minimum
<b>Nominal Operating Force:</b>	1.76N for JB15	2.65N for JB15H
<b>Total Travel:</b>	.010" (.250mm)	.012" (.300mm)

## Materials & Finishes

<b>Actuator:</b>	Glass fiber reinforced PBT for Extended actuator; PBT for Flat; Polyacetal for Short
<b>Case:</b>	Glass fiber reinforced polyamide (UL94V-0)
<b>Seal:</b>	Nitrile butadiene rubber
<b>Base:</b>	Glass fiber reinforced PBT (UL94V-0)
<b>Movable Contacts:</b>	Stainless steel
<b>Stationary Contacts:</b>	Brass with silver plating
<b>Terminals:</b>	Brass with silver plating
<b>Mounting Bracket:</b>	Phosphor bronze with tin plating

## Environmental Data

<b>Operating Temperature Range:</b>	-25°C through +70°C (-13°F through +158°F)
<b>Humidity:</b>	90 ~ 95% humidity for 240 hours @ 40°C (104°F)
<b>Vibration:</b>	10 ~ 55Hz with peak-to-peak amplitude of 1.5mm traversing the frequency range & returning in 1 minute; 3 right angled directions for 2 hours
<b>Shock:</b>	50G (490m/s <sup>2</sup> ) acceleration (tested in 6 right angled directions, with 5 shocks in each direction)

## PCB Processing

<b>Soldering:</b>	Wave Soldering Recommended. See Profile A in Supplement section. Manual Soldering: See Profile A in Supplement section.
<b>Cleaning:</b>	Automated cleaning. See Cleaning specifications in Supplement section.

## Standards & Certifications

<b>Flammability Standards:</b>	UL94V-0 rated case & base The JB Series tactiles have not been tested for UL recognition or CSA certification. These switches are designed for use in a low-voltage, low-current, logic-level circuit. When used as intended in a logic-level circuit, the results do not produce hazardous energy.
--------------------------------	--



# Distinctive Characteristics

Special bracket for right angle mounting provides added design variations.

Higher operating force type provides more pronounced operating feel.

Rubber seal construction prevents contact contamination and allows automated soldering and cleaning.

Choice of dimensions from PCB to top of cap allows design flexibility.

Dome contact gives crisp tactile feedback to positively indicate circuit transfer and assures high reliability and long life of up to 5,000,000 operations.

Slanted terminals provide a spring type action which ensures secure mounting and prevents dislodging during wave soldering.

Molded-in terminals are part of the sealed construction which allows automated soldering and washing.

Terminal spacing conforms to standard .100" (2.54mm) PCB grid.

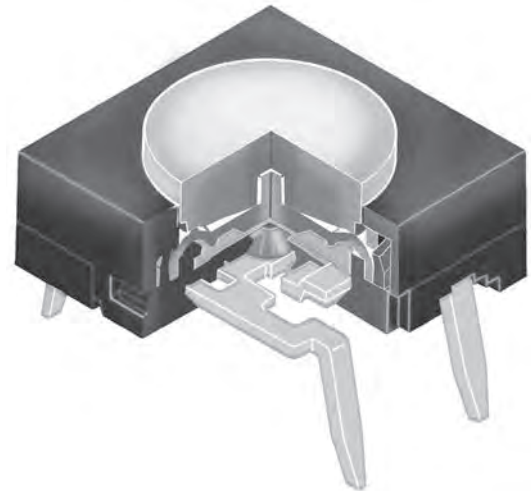

Actual Size



## Common Bus Matrix

These single pole, single throw switches can be used in a keyboard matrix and, using strapped terminals, achieve a common bus electrical configuration on a single-sided PC board.

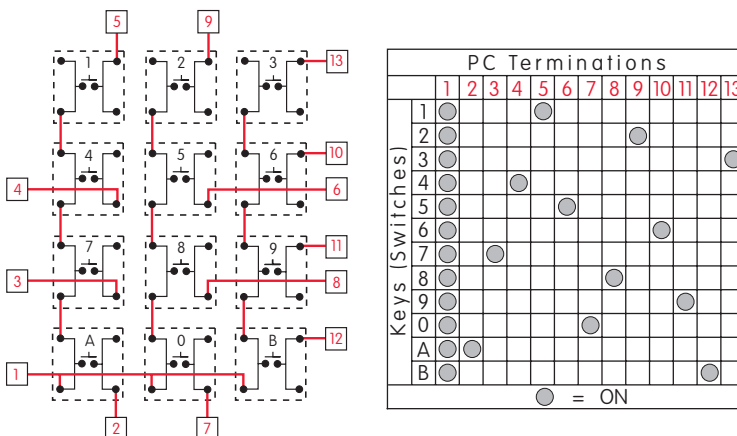

## X-Y Matrix

These single pole, single throw switches can be arranged on a single-sided PC board matrix with strapped terminals to achieve an X-Y type electrical interconnection.

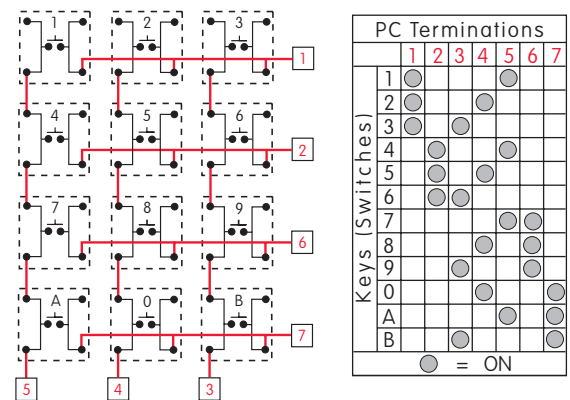

Red = PCB Trace    Black = Switch Circuit

### TYPICAL SWITCH ORDERING EXAMPLE

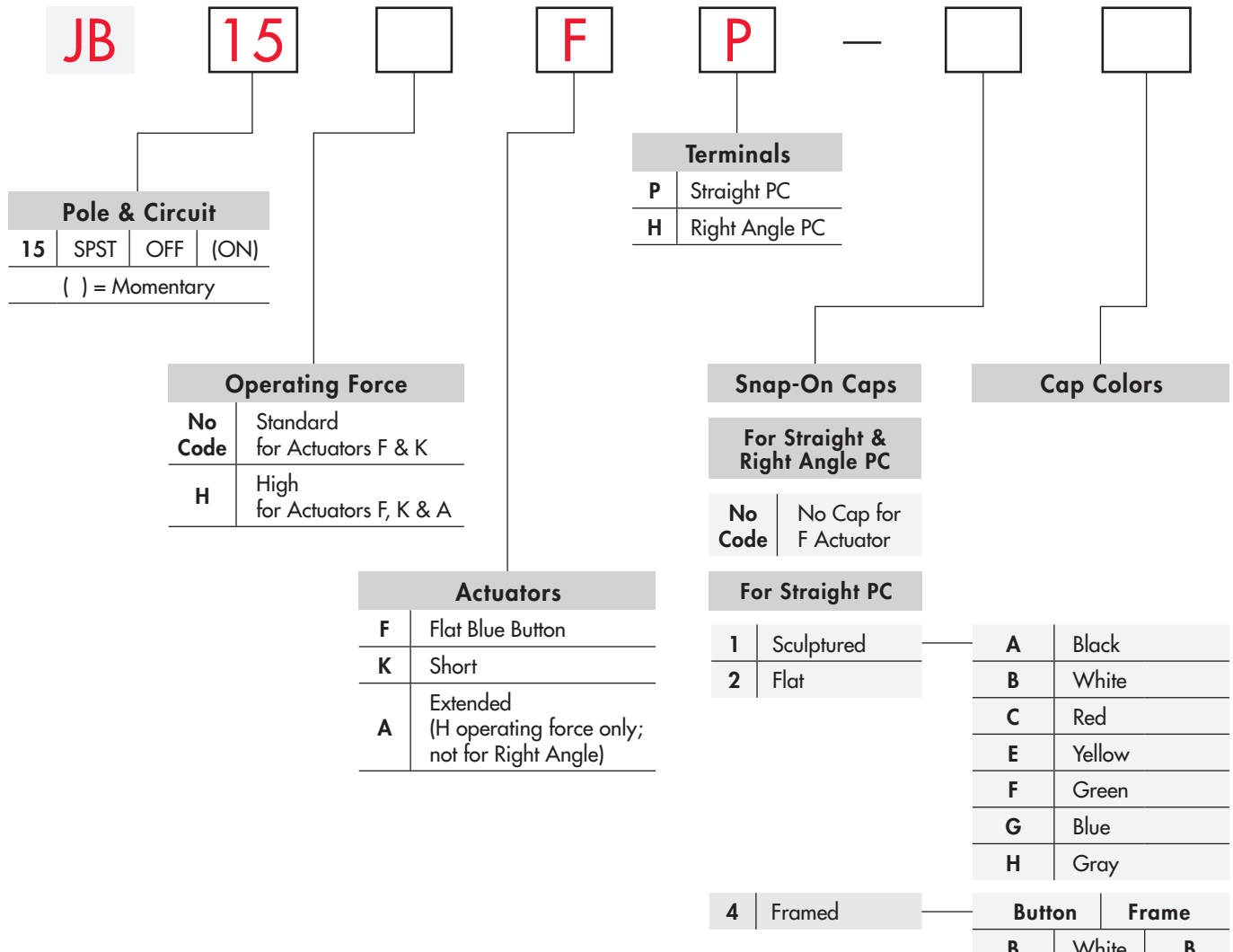

### DESCRIPTION FOR TYPICAL ORDERING EXAMPLE

**JB15FP**

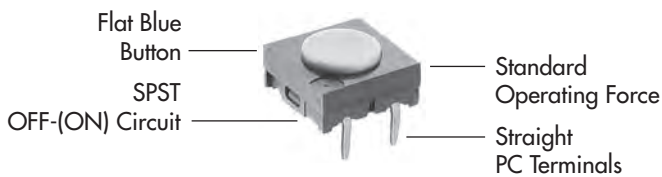

<b>5</b>	Cap with Black Mounter	<b>A</b>	Black
		<b>B</b>	White
		<b>C</b>	Red
		<b>H</b>	Gray

**For Right Angle PC**

<b>6</b>	Flat	<b>A</b>	Black
		<b>B</b>	White
		<b>C</b>	Red
		<b>H</b>	Gray

Toggles  
Rocker  
Pushbuttons  
Illuminated PB  
Programmable  
Keylocks  
Rotaries  
Slides  
Tactiles  
Tilt  
Touch  
Indicators  
Accessories  
Supplement

## POLE & CIRCUIT

		Actuator Position ( ) = Momentary		Switch Throw & Schematic	Note: Terminal numbers are shown on the switch.
Pole	Model	Normal	Down		
SP	JB15	OFF	(ON)	SPST	

## OPERATING FORCE

**No Code**

### Standard Operating Force

1.76N

For F & K Actuators

**H**

### High Operating Force

2.65N

For F, K & A Actuators

## ACTUATORS

**F**

### Flat Blue Button

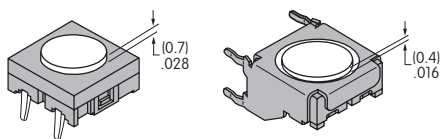

Flat button is an integral part of the switch and cannot be ordered separately.

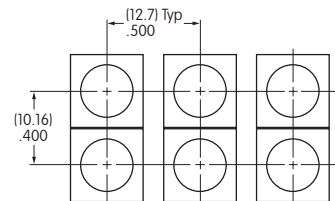
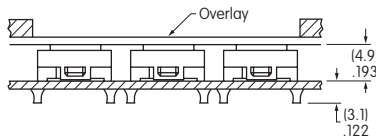

Custom keyboards can be designed with flat buttons beneath an overlay. Not applicable for right angle mounting.

**K**

### Short Actuator

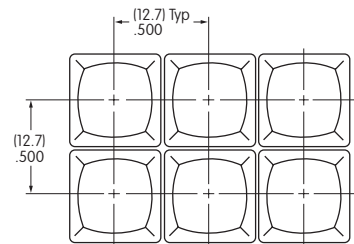
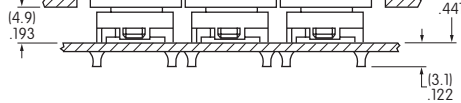
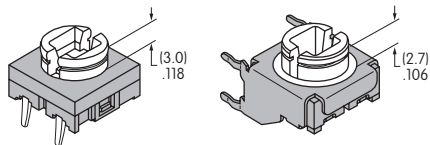

Custom keyboards can be designed with caps installed through a panel cutout (illustration with framed cap AT4078 and button AT4077). Not applicable for right angle mounting.

**A**

### Extended Actuator

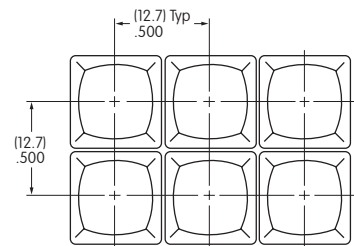
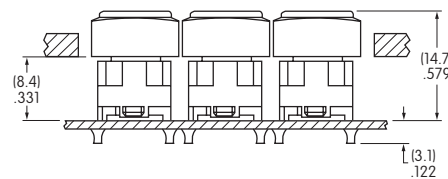
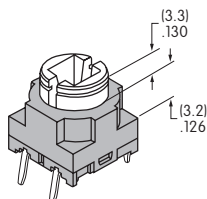

Combines with high operating force only; not for right angle.

Custom keyboards can be designed with caps installed through a panel cutout (illustration with framed cap AT4078 and button AT4077).

## TERMINALS

### P Straight PC

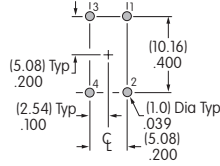
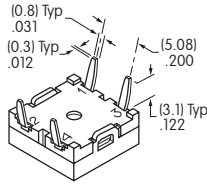

### H Right Angle PC

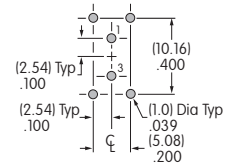
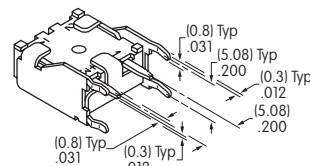

Further details shown in Typical Switch Dimensions

## SNAP-ON CAPS

### 1 AT4058 Sculptured for Straight PC

Material: Polyamide  
Finish: Matte  
Colors: A B C E F G H

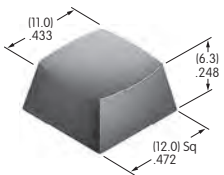

### 2 AT4059 Flat for Straight PC

Material: Polycarbonate  
Finish: Glossy  
Colors: A B C E F G H

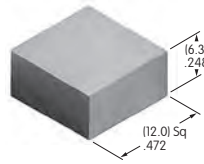

### 4 Framed: AT4077 Button & AT4078 Frame for Straight PC

Material: Polycarbonate  
Finish: Matte  
Colors: B C E F G H

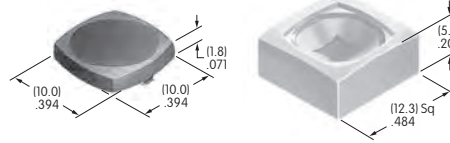

### 6 AT4139 Flat for Right Angle PC

Material: Polycarbonate  
Finish: Glossy  
Colors: A B C H

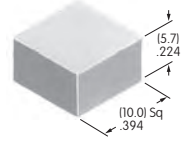

### 5 AT4140 Cap with AT547 Mounter for Straight PC

Cap  
Material: Polycarbonate  
Finish: Glossy  
Colors: A B C H

Mounter  
Material: Polyamide  
Finish: Matte  
Color: A

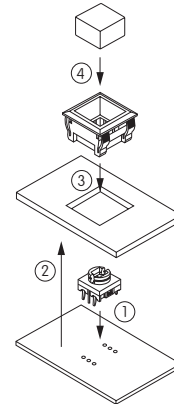

#### Assembly Procedure

1. Solder switch to PCB.
2. Install PCB in equipment.
3. Snap mounter into panel. Dimension from top of panel to top of PCB is .386" (9.8mm).
4. Snap cap onto plunger.

#### Panel Cutout & Footprint

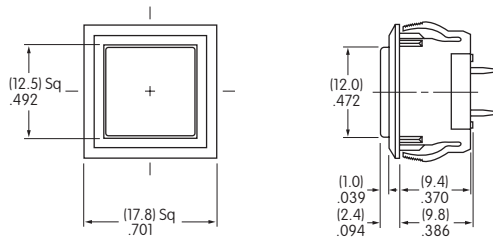

#### Panel Mounting Dimensions

Panel Thickness:  
.039" ~ .079"  
(1.0mm ~ 2.0mm)

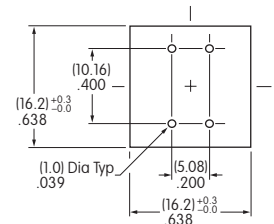

Cap Colors Available:

- A** Black   **B** White   **C** Red   **E** Yellow   **F** Green   **G** Blue   **H** Gray

Toggles  
Rockers  
Pushbuttons  
Illuminated PB  
Programmable  
Keylocks  
Rotaries  
Slides  
Tactiles  
Tilt  
Touch  
Indicators  
Accessories  
Supplement

TYPICAL SWITCH DIMENSIONS

**Flat Blue Button • Straight PC**

Spring action terminals conform to .100" (2.54mm) PCB spacing

**JB15FP**

**Flat Blue Button • Right Angle PC**

**JB15FH**

**Short Actuator      Extended Actuator      Sculptured Snap-on Cap • Straight PC**

Spring action terminals conform to .100" (2.54mm) PCB spacing

**JB15KP-1C**

**Short Actuator      Extended Actuator      Flat Snap-on Cap • Straight PC**

Spring action terminals conform to .100" (2.54mm) PCB spacing

**JB15KP-2C**

**Short Actuator      Extended Actuator      Framed Snap-on Cap • Straight PC**

Spring action terminals conform to .100" (2.54mm) PCB spacing

**JB15FHAP-4BC**

Toggles  
Rocker  
Pushbuttons  
Illuminated PB  
Programmable  
Key locks  
Rotaries  
Slides  
Tactiles  
Tilt  
Touch  
Indicators  
Accessories  
Supplement

## TYPICAL SWITCH DIMENSIONS

### Flat Snap-on Cap • Right Angle PC



**JB15KH-6C**

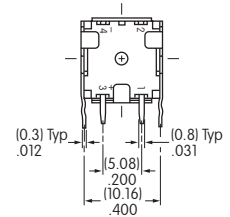
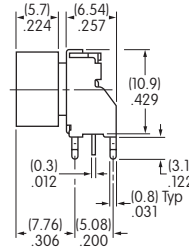
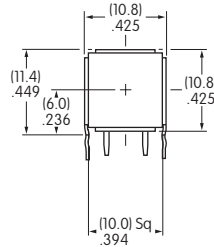

## LEGENDS

NKK Switches can provide custom legends for caps. Contact factory for more information.

### Shaded Areas are Printable Areas

AT4058



AT4059 & AT4140

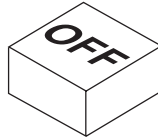

AT4077 Button

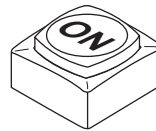

AT4139

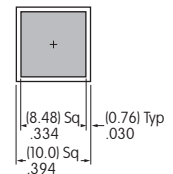
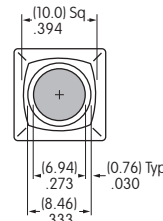
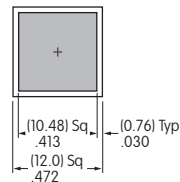
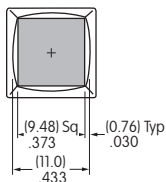
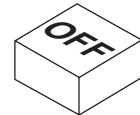

**Recommended Print Method:** Screen Print or Pad Print. Epoxy based ink is recommended.



# General Specifications

## Electrical Capacity (Resistive Load)

**Low/Logic Level:** 50mA @ 24V DC maximum for Standard Operating Force models  
125mA @ 24V DC maximum for High Operating Force models

## Other Ratings

	Standard Operating Force	High Operating Force
<b>Contact Resistance:</b>	50 milliohms maximum	50 milliohms maximum
<b>Insulation Resistance:</b>	500 megohms minimum @ 250V DC	500 megohms minimum @ 250V DC
<b>Dielectric Strength:</b>	250V AC minimum for 1 minute minimum	250V AC minimum for 1 minute minimum
<b>Mechanical Life:</b>	5,000,000 operations minimum	1,000,000 operations minimum
<b>Electrical Life:</b>	5,000,000 operations minimum	1,000,000 operations minimum
<b>Nominal Operating Force:</b>	1.76N for JB15L	2.65N for JB15HL & JB15HB
<b>Total Travel:</b>	.010" (.254mm)	.012" (.300mm)

## Materials & Finishes

<b>Actuator:</b>	Polyacetal for Short; Glass fiber reinforced PBT for Extended
<b>Case:</b>	Glass fiber reinforced polyamide (UL94V-0)
<b>Seal:</b>	Nitrile butadiene rubber
<b>Base:</b>	Glass fiber reinforced PBT (UL94V-0)
<b>Movable Contacts:</b>	Stainless steel
<b>Stationary Contacts:</b>	Brass with silver plating
<b>Terminals:</b>	Brass with silver plating

## Environmental Data

<b>Operating Temperature Range:</b>	-25°C through +70°C (-13°F through +158°F)
<b>Humidity:</b>	90 ~ 95% humidity for 240 hours @ 40°C (104°F)
<b>Vibration:</b>	10 ~ 55Hz with peak-to-peak amplitude of 1.5mm traversing the frequency range & returning in 1 minute; 3 right angled directions for 2 hours
<b>Shock:</b>	50G (490m/s <sup>2</sup> ) acceleration (tested in 6 right angled directions, with 5 shocks in each direction)

## PCB Processing

<b>Soldering:</b>	Wave Soldering recommended. See Profile A in Supplement section. Manual Soldering: See Profile A in Supplement section.
<b>Cleaning:</b>	Automated cleaning. See Cleaning specifications in Supplement section.

## Standards & Certifications

<b>Flammability Standards:</b>	UL94V-0 rated case & base The JB Series tactiles have not been tested for UL recognition or CSA certification. These switches are designed for use in a low-voltage, low-current, logic-level circuit. When used as intended in a logic-level circuit, the results do not produce hazardous energy.
--------------------------------	--



# Distinctive Characteristics

Choice of dimensions from PCB to top of cap adds to design flexibility.

Bright, full-face illumination with red, green, or yellow LEDs for attractive, functional panel layouts.

Higher operating force type provides more pronounced operating feel.

Dome contact gives crisp tactile feedback to positively indicate circuit transfer and assures high reliability and long life of up to 5,000,000 operations.

Rubber seal construction prevents contact contamination and allows automated soldering and cleaning.

Slanted terminals provide a spring type action which ensures secure mounting and prevents dislodging during wave soldering.

Molded-in terminals are part of the sealed construction which allows automated soldering and cleaning.

Terminal spacing conforms to standard .100" (2.54mm) PCB grid.

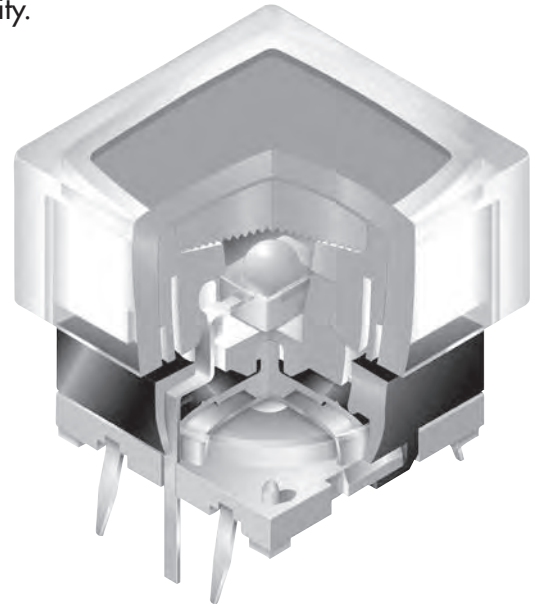

Actual Size



## Common Bus Matrix

These single pole, single throw switches can be used in a keyboard matrix and, using strapped terminals, achieve a common bus electrical configuration on a single-sided PC board.

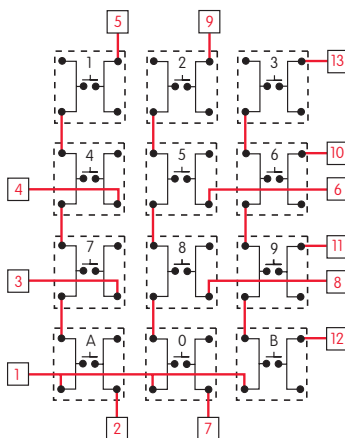

PC Terminations		1	2	3	4	5	6	7	8	9	10	11	12	13
Keys (Switches)	1													
	2													
	3													
	4													
	5													
	6													
	7													
	8													
	9													
	0													
	A													
	B													

● = ON

## X-Y Matrix

These single pole, single throw switches can be arranged on a single-sided PC board matrix with strapped terminals to achieve an X-Y type electrical interconnection.

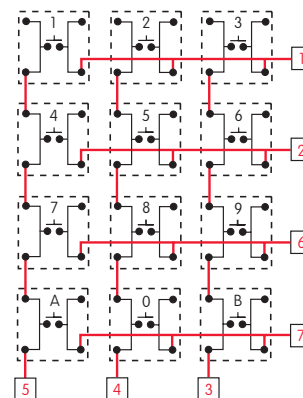

PC Terminations		1	2	3	4	5	6	7
Keys (Switches)	1							
	2							
	3							
	4							
	5							
	6							
	7							
	8							
	9							
	0							
	A							
	B							

● = ON

Red = PCB Trace    Black = Switch Circuit

### TYPICAL SWITCH ORDERING EXAMPLE

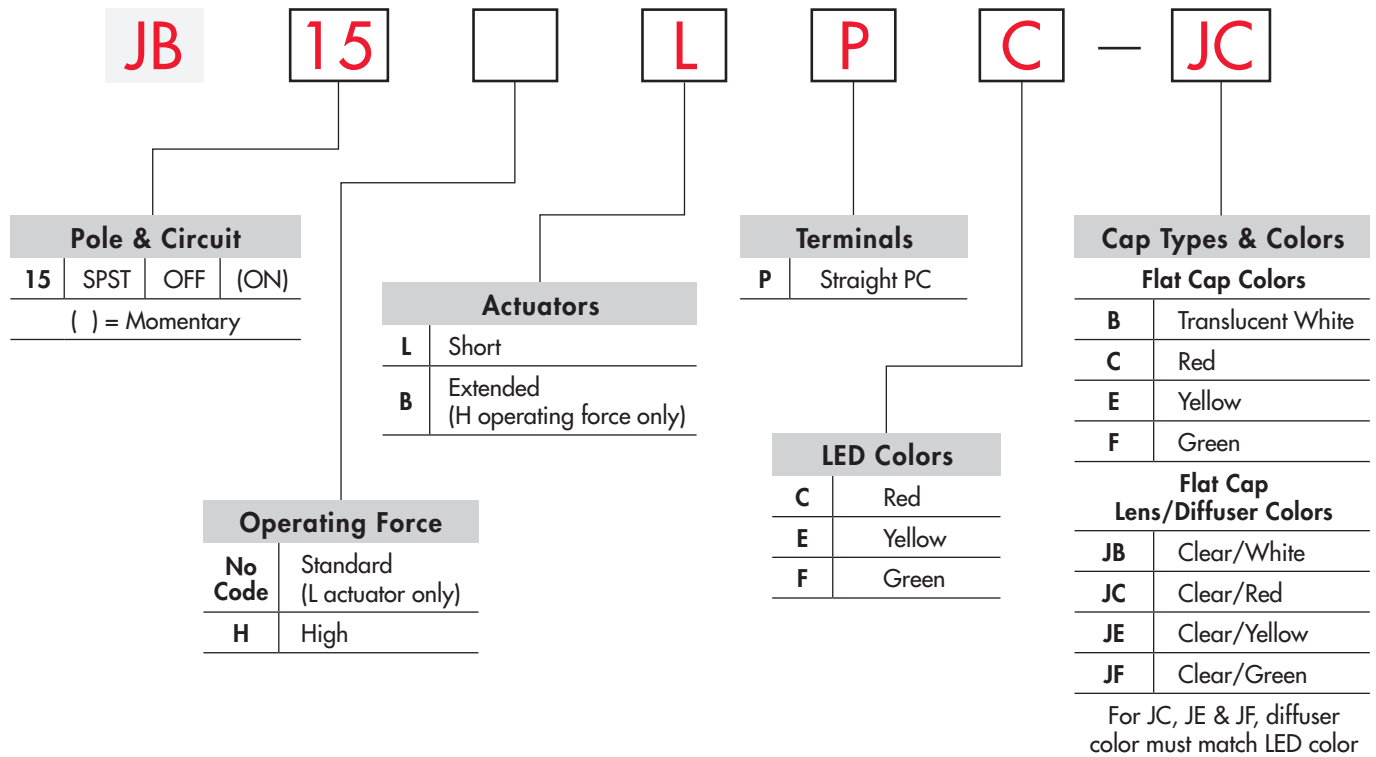

### DESCRIPTION FOR TYPICAL ORDERING EXAMPLE

**JB15LPC-JC**



**Framed Cap Button/Frame Colors**

BB	White/White
BC	White/Red
BE	White/Yellow
BF	White/Green
BH	White/Gray

### POLE & CIRCUIT

		Actuator Position ( ) = Momentary		Switch Throw & Schematic	LED Schematic	Notes: Terminal numbers are shown on switch. LED circuit is isolated & requires external power source.
Pole & Throw	Model	Normal	Down			
SPST	JB15	OFF	(ON)	SPST		

## OPERATING FORCE

**No Code**

**Standard Nominal Operating Force**  
1.76N

Available with short actuator only (code L)

**H**

**High Nominal Operating Force**  
2.65N

Available with both short and extended actuators

## ACTUATORS

**L**

**Short Actuator**

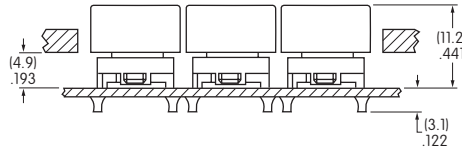
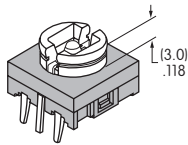

Custom keyboards can be designed with caps installed through a panel cutout (illustration with cap AT4060).

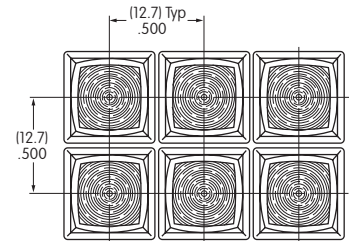

**B**

**Extended Actuator**

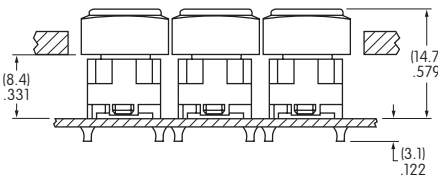
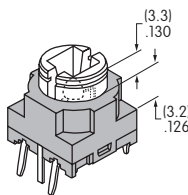

Custom keyboards can be designed with caps installed through a panel cutout (illustration with cap AT4076).

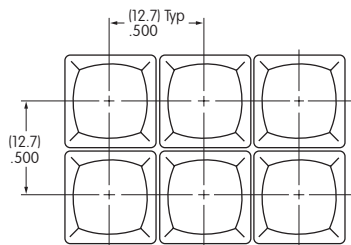

High operating force only

## TERMINALS

**P**

**Straight PC Terminals**

Further details in Typical Switch Dimensions

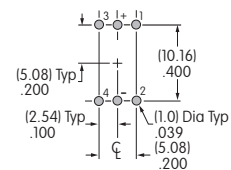
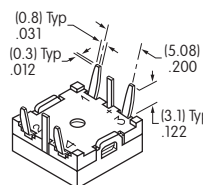

## LED COLORS & SPECIFICATIONS

LEDs are supplied as an integral part of illuminated devices and are not available separately.

LED polarity markings are on the bottom of the switch.

The electrical specifications shown here are determined at a basic temperature of 25°C.

If the source voltage exceeds the rated voltage, a ballast resistor is required.

The resistor value can be calculated by using the formula in the Supplement section.

		<b>C</b>	<b>E</b>	<b>F</b>
Color		Red	Yellow	Green
Maximum Forward Current	$I_{FM}$	30mA	20mA	30mA
Typical Forward Current	$I_F$	10mA	10mA	10mA
Forward Voltage	$V_F$	1.8V	2.0V	2.1V
Maximum Reverse Voltage	$V_{RM}$	5V	5V	5V
Current Reduction Rate Above 25°C	$\Delta I_F$	* 0.50mA/°C	* 0.33mA/°C	* 0.50mA/°C
Ambient Temperature Range		-25°C ~ +70°C		

\* Applies to temperatures above 50°C

## SNAP-ON CAPS

### AT4135 Flat

Cap Color Codes:

- |                            |                 |
|----------------------------|-----------------|
| <b>B</b> Translucent White | <b>E</b> Yellow |
| <b>C</b> Red               | <b>F</b> Green  |

Material: Polycarbonate Finish: Frosted

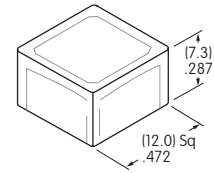

### AT4060 Flat

Lens/Diffuser Color Codes:

- |                                   |
|-----------------------------------|
| <b>JB</b> Clear/Translucent White |
| <b>JC</b> Clear/Red               |
| <b>JE</b> Clear/Yellow            |
| <b>JF</b> Clear/Green             |

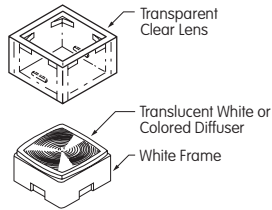
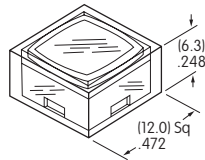

### Framed: AT4076 Button with Frame

Translucent Button/Frame Color Codes:

- |                        |
|------------------------|
| <b>BB</b> White/White  |
| <b>BC</b> White/Red    |
| <b>BE</b> White/Yellow |
| <b>BF</b> White/Green  |
| <b>BH</b> White/Gray   |

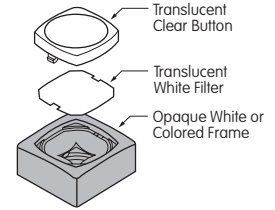
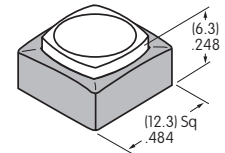

Material: Polycarbonate Lens Finish: Glossy Material: Polycarbonate Button Finish: Frosted

## TYPICAL SWITCH DIMENSIONS

### Flat Snap-on Cap

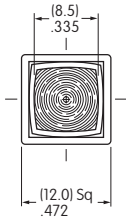

**Short Actuator**

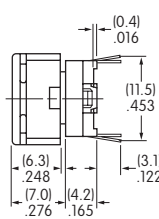

**Extended Actuator**

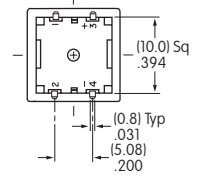
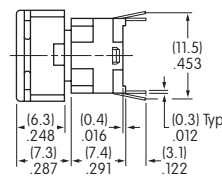

**JB15LPC-JC**

Spring action terminals conform to .100" (2.54mm) PCB spacing

### Framed Snap-on Cap

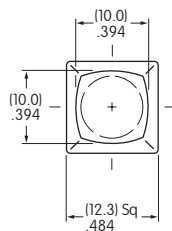

**Short Actuator**

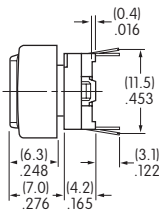

**Extended Actuator**

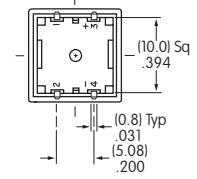
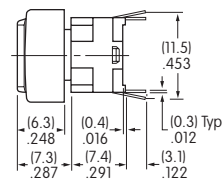

**JB15HBPC-BC**

Spring action terminals conform to .100" (2.54mm) PCB spacing

## LEGENDS

NKK Switches can provide custom legends for caps. Contact factory for more information.

### Suggested Printable Area for Cap, Lens, or Button

#### Recommended Methods:

Laser Etch, Screen Print or Pad Print

Laser Etch or Pad Print

Epoxy based ink is recommended.



Epoxy based ink is recommended.

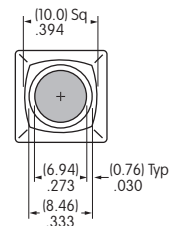
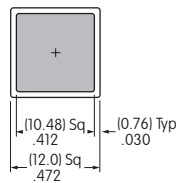
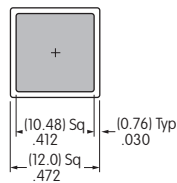

Shaded areas are printable areas.

### Suggested Printable Area for Film Insert

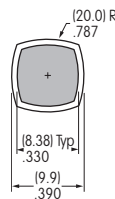
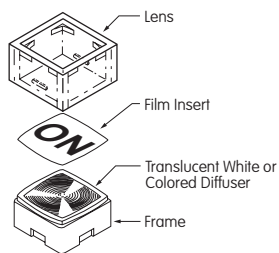

Shaded area is printable area.

Film Insert: Clear Polyester 7 mil maximum thickness

# General Specifications

## Electrical Capacity (Resistive Load)

Low/Logic Level: 50mA @ 24V DC

## Other Ratings

<b>Contact Resistance:</b>	50 milliohms maximum
<b>Insulation Resistance:</b>	500 megohms minimum @ 250V DC
<b>Dielectric Strength:</b>	250V AC minimum for 1 minute minimum
<b>Mechanical Life:</b>	500,000 operations minimum
<b>Electrical Life:</b>	500,000 operations minimum
<b>Nominal Operating Force:</b>	1.96N for sculptured actuator 2.0N for piano actuator 3.0N for square & round flush actuators
<b>Total Travel:</b>	Flush Actuators .016" (0.4mm) Sculptured & Piano Actuators .031" (0.8mm)

## Materials & Finishes

<b>Actuator:</b>	Polyamide
<b>Case:</b>	Glass fiber reinforced polyamide
<b>Seal:</b>	Nitrile butadiene rubber
<b>Base:</b>	Glass fiber reinforced polyester
<b>Movable Contact:</b>	Phosphor bronze with silver plating
<b>Stationary Contacts:</b>	Brass with silver plating
<b>Terminals:</b>	Brass with silver plating

## Environmental Data

<b>Operating Temperature Range:</b>	-25°C through +85°C (-13°F through +185°F)
<b>Humidity:</b>	90 ~ 95% humidity for 96 hours @ 40°C (104°F)
<b>Vibration:</b>	10 ~ 55Hz with peak-to-peak amplitude of 1.5mm traversing the frequency range & returning in 1 minute; 3 right angled directions for 2 hours
<b>Shock:</b>	50G (490m/s <sup>2</sup> ) acceleration (tested in 6 right angled directions, with 5 shocks in each direction)

## PCB Processing

<b>Soldering:</b>	Wave Soldering Recommended. See Profile A in Supplement section. Manual Soldering: See Profile A in Supplement section.
<b>Cleaning:</b>	Automated cleaning. See Cleaning specifications in Supplement section.

## Standards & Certifications

The JF Series tactiles have not been tested for UL recognition or CSA certification. These switches are designed for use in a low-voltage, low-current, logic-level circuit. When used as intended in a logic-level circuit, the results do not produce hazardous energy.

# Distinctive Characteristics

Extremely low profile of 5mm from PCB to top of switch.

Rubber seal construction prevents contact contamination and allows automated soldering and cleaning.

Minimal operating force and short stroke permit light touch operation.

Dome contact gives crisp tactile and audible feedback to positively indicate circuit transfer and assures high reliability and long life.

Wide choice of body shapes and colors.

Crimped terminals provide a spring type action to ensure secure mounting and prevent dislodging during wave soldering.

Space saving body dimensions provide for compact, side-by-side mounting on a standard grid.

Terminal spacing conforms to standard .100" (2.54mm) PCB grid.



Actual Size



## Common Bus Matrix

These single pole, single throw switches can be used in a keyboard matrix and, using strapped terminals, achieve a common bus electrical configuration on a single-sided PC board.

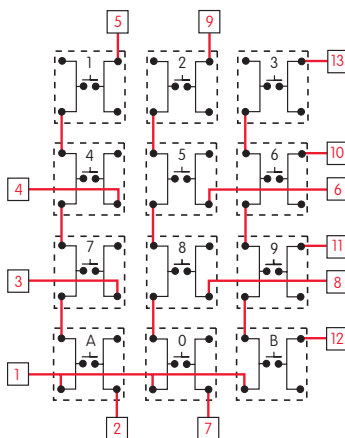

PC Terminations		1	2	3	4	5	6	7	8	9	10	11	12	13
Keys (Switches)	1	●												
	2		●											
	3			●										
	4				●									
	5					●								
	6						●							
	7							●						
	8								●					
	9									●				
	0										●			
	A											●		
	B												●	

● = ON

## X-Y Matrix

These single pole, single throw switches can be arranged on a single-sided PC board matrix with strapped terminals to achieve an X-Y type electrical interconnection.

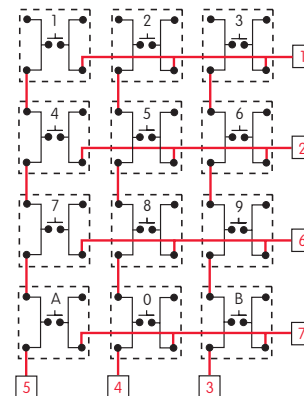

PC Terminations		1	2	3	4	5	6	7					
Keys (Switches)	1	●											
	2		●										
	3			●									
	4				●								
	5					●							
	6						●						
	7							●					
	8								●				
	9									●			
	0										●		
	A											●	
	B												●

● = ON

Red = PCB Trace    Black = Switch Circuit

### TYPICAL SWITCH ORDERING EXAMPLE

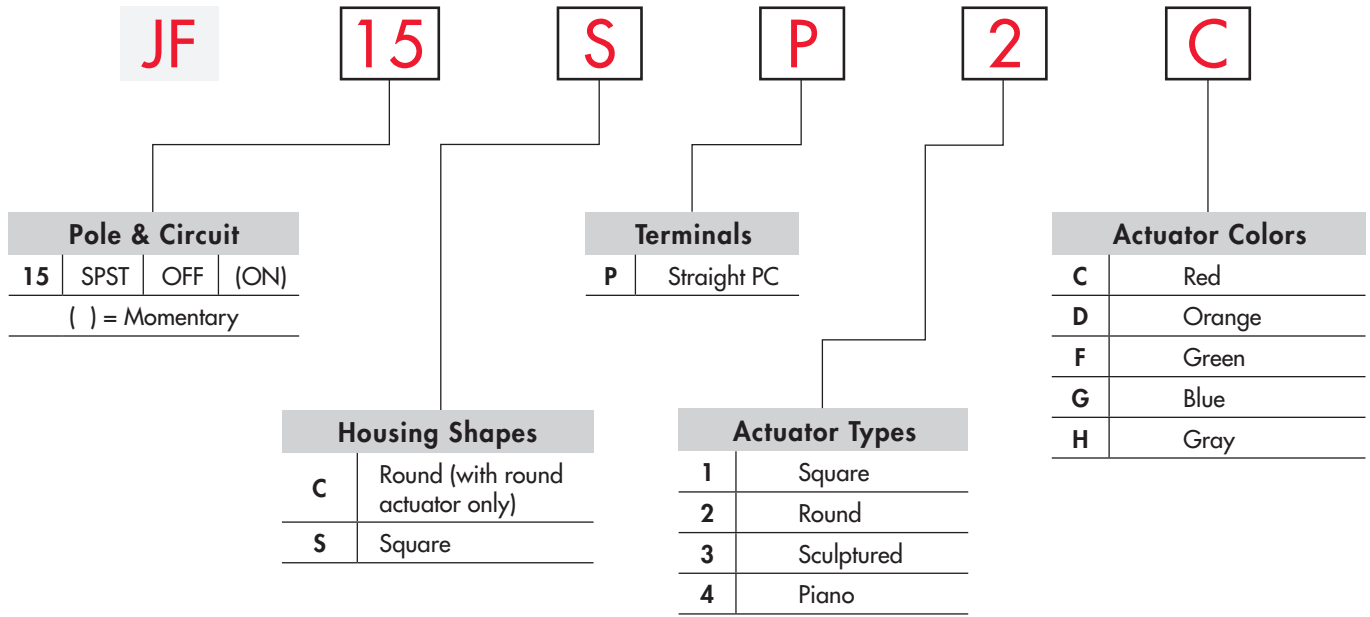

### DESCRIPTION FOR TYPICAL ORDERING EXAMPLE

**JF15SP2C**

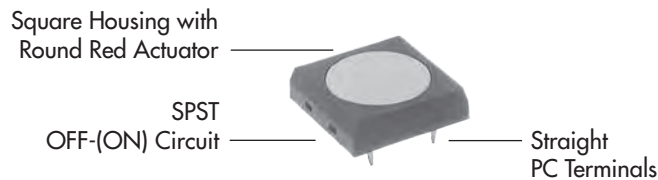

### POLE & CIRCUIT

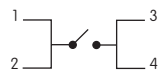
		Actuator Position ( ) = Momentary		Switch Throw & Schematic	Note: Terminal numbers are shown on the switch.
Pole	Model	Normal	Down		
SP	JF15	OFF	(ON)	SPST 	

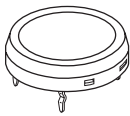
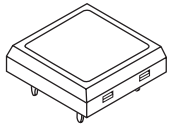
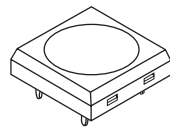
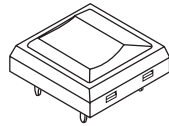
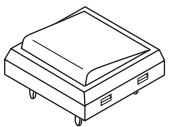

HOUSING SHAPES & ACTUATOR TYPES

<p><b>C</b> Round Housing</p>	<p><b>S</b> Square Housing</p>			
<p><b>2</b> Round Actuator</p> 	<p><b>1</b> Square Actuator</p> 	<p><b>2</b> Round Actuator</p> 	<p><b>3</b> Sculptured Actuator</p> 	<p><b>4</b> Piano Actuator</p> 

Actuator Colors Available:

**C** Red

**D** Orange

**F** Green

**G** Blue

**H** Gray

Housing is Black

TERMINALS & PANEL DESIGN

**P** Straight PC

Additional details in Typical Switch Dimensions

Versatile panel arrangements can be made to fit individual design needs.

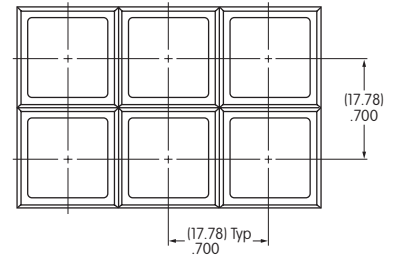
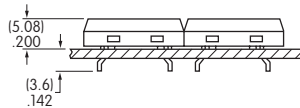
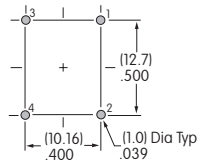
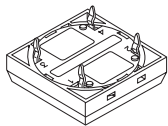

TYPICAL SWITCH DIMENSIONS

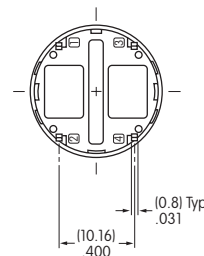
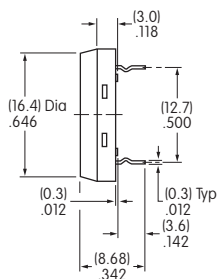
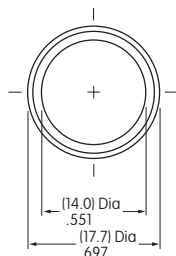

Round Actuator



JF15CP2C

### TYPICAL SWITCH DIMENSIONS

#### Square Actuator

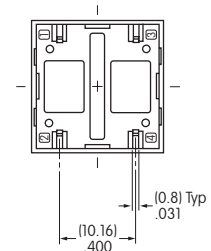
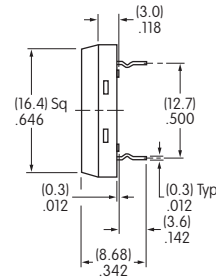
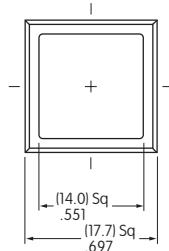

JF15SP1C

#### Round Actuator

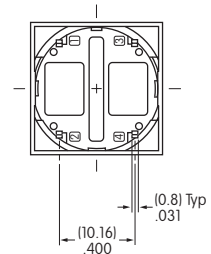
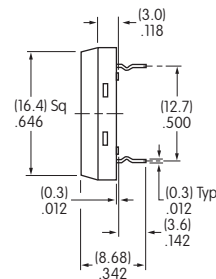
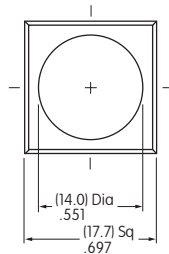
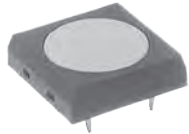

JF15SP2C

#### Sculptured Actuator

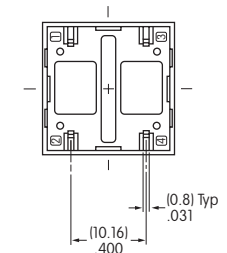
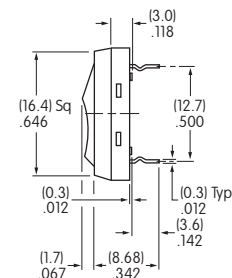
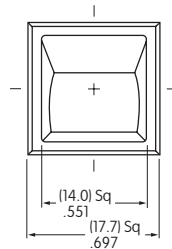

JF15SP3C

#### Piano Actuator

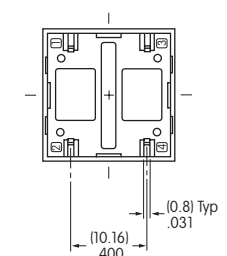
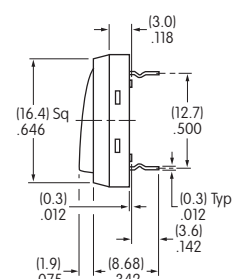
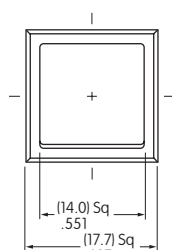
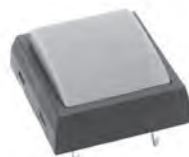

JF15SP4C

LEGENDS

NKK Switches can provide custom legends for caps. Contact factory for more information.

Shaded Areas are Printable Areas

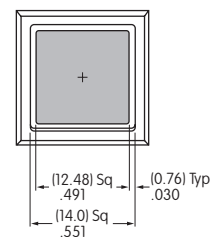
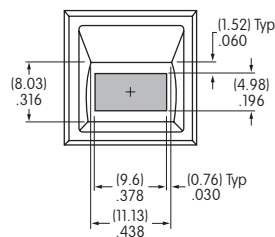
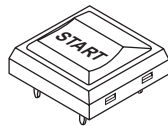
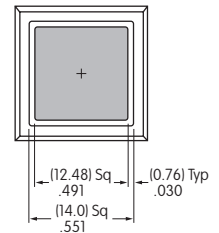
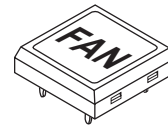
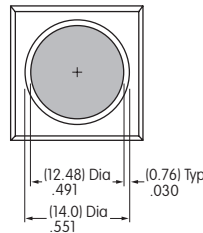
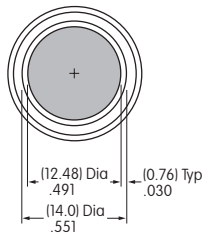

Recommended Print Methods: Screen Print or Pad Print. Epoxy based ink is recommended.

# General Specifications

## Electrical Capacity (Resistive Load)

Low/Logic Level: 50mA @ 24V DC

## Other Ratings

**Contact Resistance:** 50 milliohms maximum

**Insulation Resistance:** 500 megohms minimum @ 250V DC

**Dielectric Strength:** 250V AC minimum for 1 minute minimum

**Mechanical Life:** 500,000 operations minimum

**Electrical Life:** 500,000 operations minimum

**Nominal Operating Force:** 3.0N for flush actuator

2.0N for sculptured actuator

**Total Travel:** Flush Actuators .016" (0.4mm); Sculptured Actuator: .031" (0.8mm)

## Materials & Finishes

**Actuator:** Polyamide for spot illuminated; polycarbonate for full face

**Case:** Glass fiber reinforced polyamide

**Seal:** Nitrile butadiene rubber

**Base:** Glass fiber reinforced polyester

**Movable Contact:** Phosphor bronze with silver plating

**Stationary Contacts:** Brass with silver plating

**Terminals:** Brass with silver plating

## Environmental Data

**Operating Temperature Range:** -25°C through +70°C (-13°F through +158°F)

**Humidity:** 90 ~ 95% humidity for 96 hours @ 40°C (104°F)

**Vibration:** 10 ~ 55Hz with peak-to-peak amplitude of 1.5mm traversing the frequency range & returning in 1 minute; 3 right angled directions for 2 hours

**Shock:** 50G (490m/s<sup>2</sup>) acceleration (tested in 6 right angled directions, with 5 shocks in each direction)

## PCB Processing

**Soldering:** Wave Soldering recommended. See Profile A in Supplement section.

Manual Soldering: See Profile A in Supplement section.

**Cleaning:** Automated cleaning. See Cleaning specifications in Supplement section.

Switches should not be operated or have any pressure on the actuators during cleaning.

Full face illuminated models suitable only for bottom board spray wash to avoid contamination of the 2-layered actuator, which may compromise the aesthetics.

## Standards & Certifications

The JF Series tactiles have not been tested for UL recognition or CSA certification.

These switches are designed for use in a low-voltage, low-current, logic-level circuit.

When used as intended in a logic-level circuit, the results do not produce hazardous energy.

# Distinctive Characteristics

Extremely low profile of .224" (5.7mm) from PCB to top of switch.

Red, green, or yellow LED with spot or full face illumination.

Rubber seal construction prevents contact contamination and allows automated soldering and cleaning.

Minimal operating force and short stroke permit light touch operation.

Dome contact gives crisp tactile and audible feedback to positively indicate circuit transfer and assures high reliability and long life.

Space saving body dimensions provide for compact, side-by-side mounting on a standard grid.

Crimped terminals ensure secure mounting and prevent dislodging during wave soldering.

Terminal spacing conforms to standard .100" (2.54mm) PCB grid.

Matching indicator available and shown at the end of Section M.

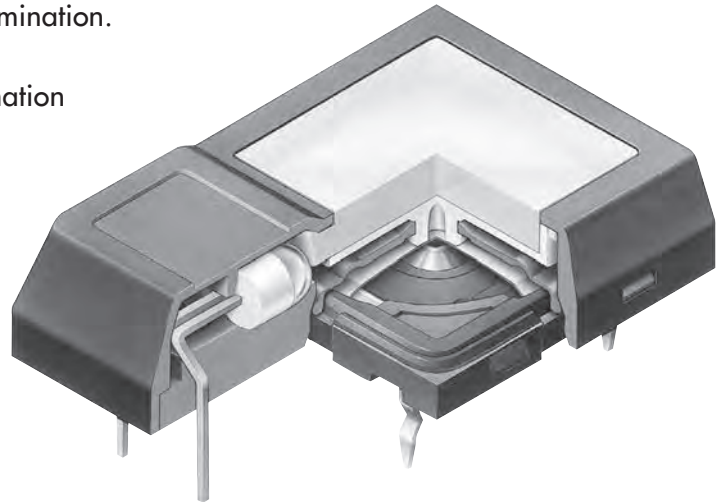

Actual Size



## Common Bus Matrix

These single pole, single throw switches can be used in a keyboard matrix and, using strapped terminals, achieve a common bus electrical configuration on a single-sided PC board.

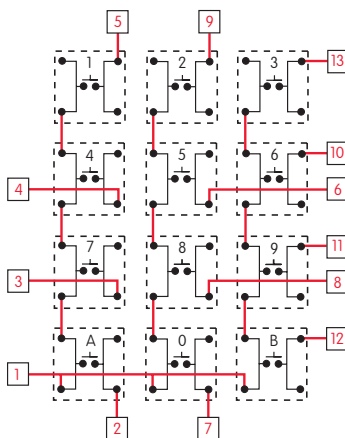

PC Terminations		1	2	3	4	5	6	7	8	9	10	11	12	13
Keys (Switches)	1	●												
	2		●											
	3			●										
	4				●									
	5					●								
	6						●							
	7							●						
	8								●					
	9									●				
	0										●			
	A											●		
	B												●	

● = ON

## X-Y Matrix

These single pole, single throw switches can be arranged on a single-sided PC board matrix with strapped terminals to achieve an X-Y type electrical interconnection.

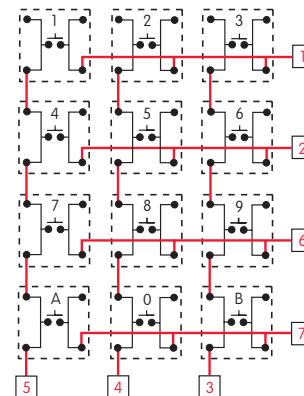

PC Terminations		1	2	3	4	5	6	7
Keys (Switches)	1	●						
	2		●					
	3			●				
	4				●			
	5					●		
	6						●	
	7							●
	0							

● = ON

Red = PCB Trace Black = Switch Circuit

### TYPICAL SWITCH ORDERING EXAMPLE

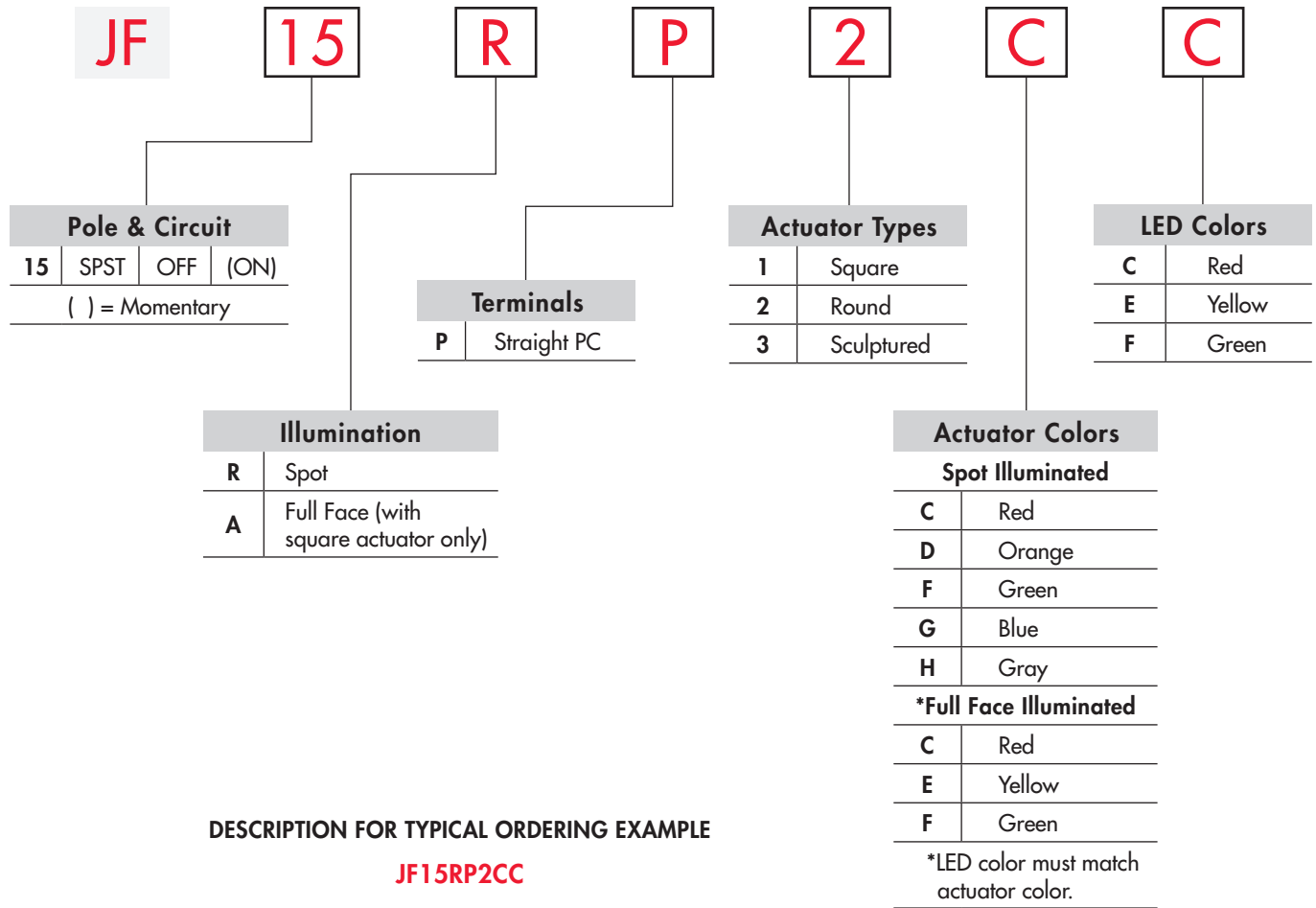

### DESCRIPTION FOR TYPICAL ORDERING EXAMPLE

**JF15RP2CC**



### POLE & CIRCUIT

Pole	Model	Actuator Position ( ) = Momentary		Switch Throw & Schematic	LED Schematic	Notes: Terminal numbers are shown on switch. LED circuit is isolated & requires external power source.
		Normal	Down			
SP	JF15	OFF	(ON)	SPST		

Toggles  
Rockers  
Pushbuttons  
Illuminated PB  
Programmable  
Keylocks  
Rotaries  
Slides  
Tactiles  
Tilt  
Touch  
Indicators  
Accessories  
Supplement

ILLUMINATION & ACTUATOR TYPES

**R** Spot Illumination

**A** Full Face Illumination

**1** Square Actuator

**2** Round Actuator

**3** Sculptured Actuator

**1** Square Actuator

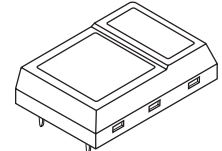
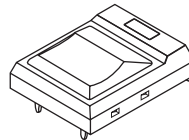
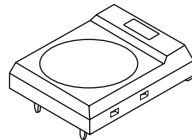
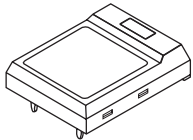

Actuator Colors Available: C, D, F, G, H  
Housing is black

Actuator Colors Available: C, E, F  
Housing is black

Color Codes: **C** Red **D** Orange **E** Yellow **F** Green **G** Blue **H** Gray

Flexible Panel Design

Versatile panel arrangements can be made to fit individual design needs.

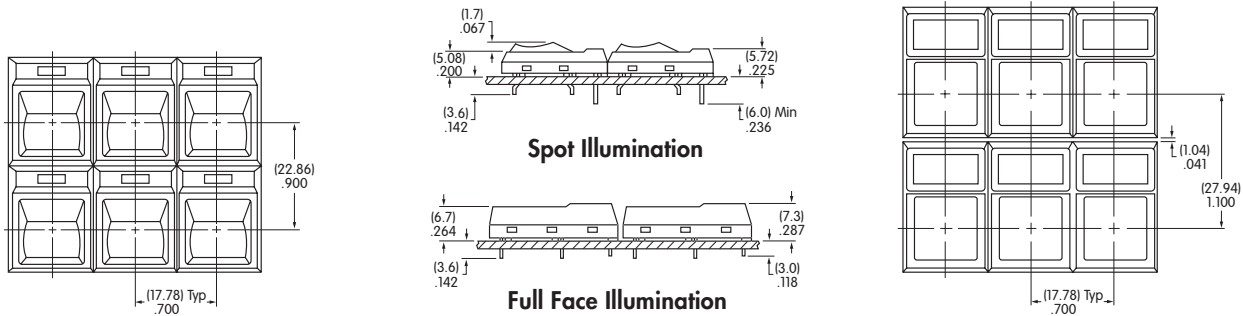

TERMINALS

**P** Straight PC Terminals

With isolated lamp circuit  
Further details in Typical Switch Dimensions

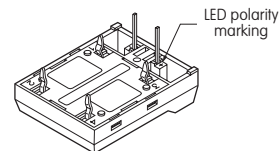

LED COLORS & SPECIFICATIONS

LEDs are supplied as an integral part of the switch. The electrical specifications shown are determined at a basic temperature of 25°C. If the source voltage exceeds the rated voltage, a ballast resistor is required. The resistor value can be calculated by using the formula in the Supplement section.

Color	Spot Illumination			Full Face Illumination		
	Red <b>C</b>	Yellow <b>E</b>	Green <b>F</b>	Red <b>C</b>	Yellow <b>E</b>	Green <b>F</b>
Maximum Forward Current	$I_{FM}$ 40mA	40mA	40mA	30mA	30mA	30mA
Typical Forward Current	$I_F$ 30mA	30mA	30mA	20mA	20mA	20mA
Forward Voltage	$V_F$ 1.7V	2.2V	2.2V	1.77V	2.1V	2.3V
Maximum Reverse Voltage	$V_{RM}$ 4V	4V	4V	4V	4V	4V
Current Reduction Rate Above 25°C	$\Delta I_F$ 0.67mA/°C	0.67mA/°C	0.67mA/°C	0.4mA/°C	0.4mA/°C	0.4mA/°C
Ambient Temperature Range	-25° ~ +70°C			-25° ~ +70°C		

Toggle  
Rockers  
Pushbuttons  
Illuminated PB  
Programmable  
Keylocks  
Rotaries  
Slides  
Tactiles  
Tilt  
Touch  
Indicators  
Accessories  
Supplement

## TYPICAL SWITCH DIMENSIONS

### Spot Illuminated with Square Actuator



**JF15RP1CC**

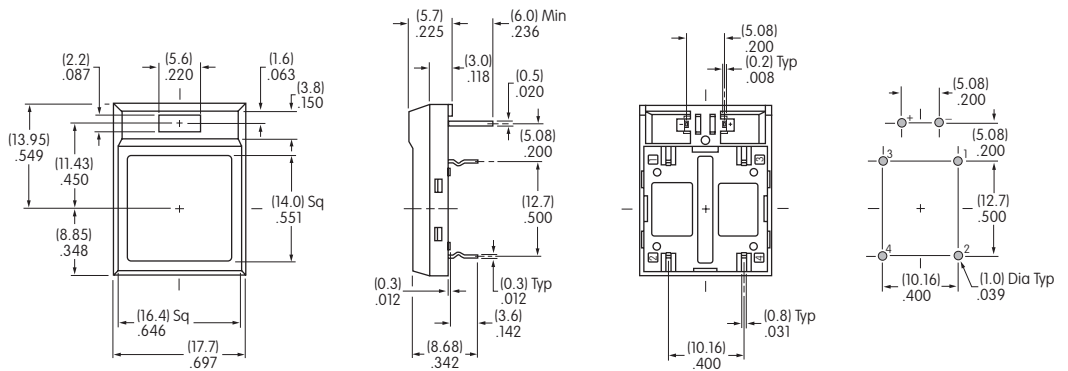

### Spot Illuminated with Round Actuator



**JF15RP2CC**

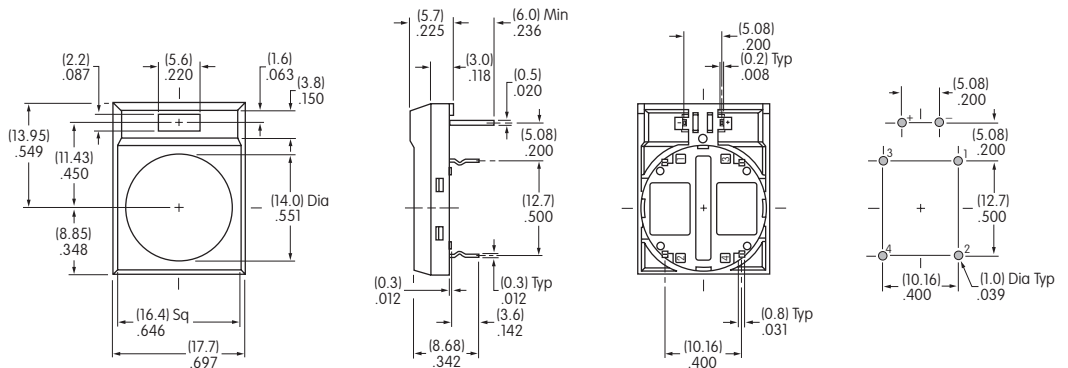

### Spot Illuminated with Sculptured Actuator



**JF15RP3CC**

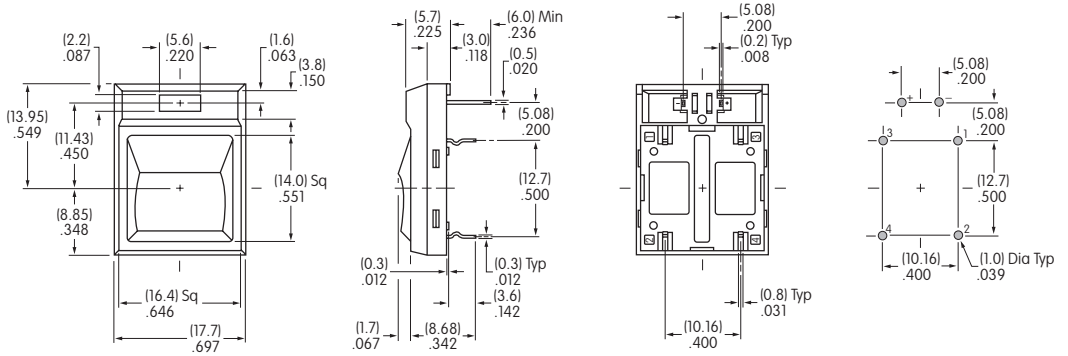

### Full Face Illuminated with Square Actuator



**JF15AP1CC**

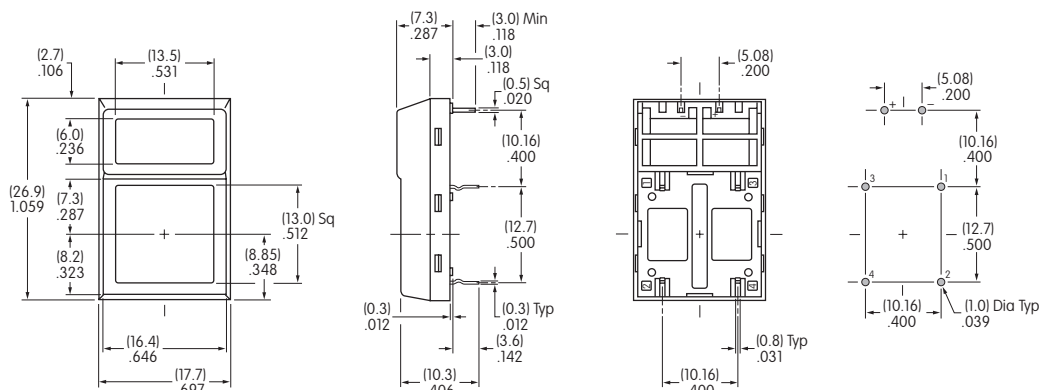

Toggles

Rockers

Pushbuttons

Illuminated PB

Illuminated PB

Programmable

Keylocks

Rotaries

Slides

Tactiles

Tilt

Touch

Indicators

Accessories

Supplement



LEGENDS

NKK Switches can provide custom legends for caps. Contact factory for more information.

Suggested Printable Area

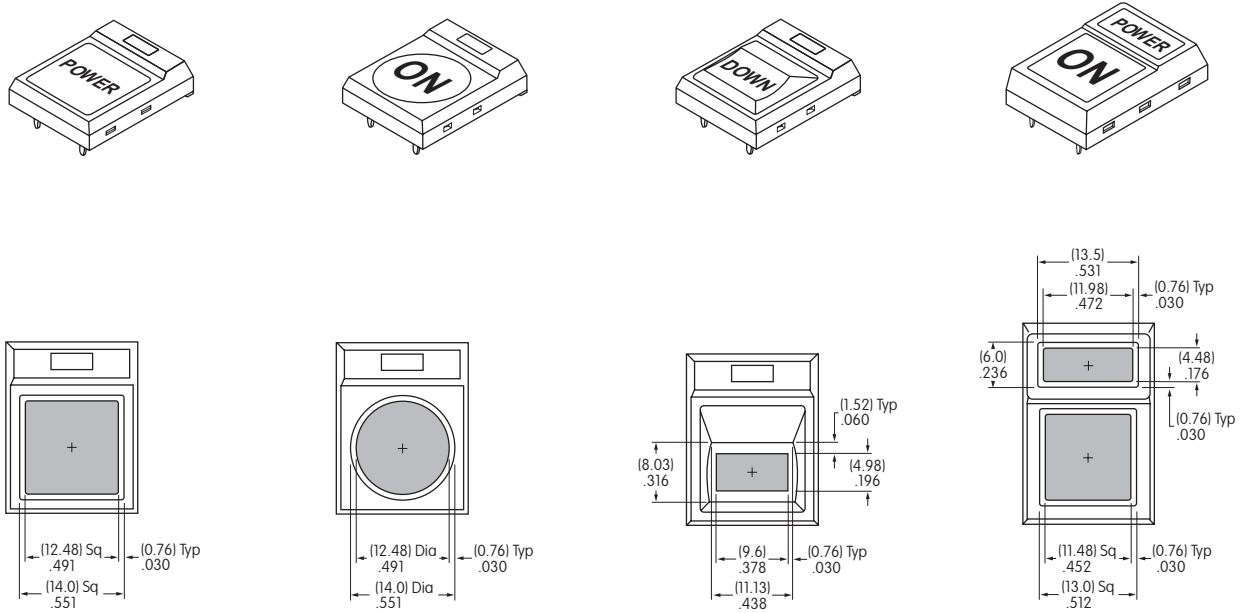

Recommended Print Method:

Screen Print or Pad Print

Epoxy based ink is recommended.

Shaded areas are printable areas.

# General Specifications

## Electrical Capacity (Resistive Load)

Low/Logic Level: 50mA @ 24V DC

## Other Ratings

<b>Contact Resistance:</b>	50 milliohms maximum
<b>Insulation Resistance:</b>	500 megohms minimum @ 250V DC
<b>Dielectric Strength:</b>	250V AC minimum for 1 minute minimum
<b>Mechanical Life:</b>	1,000,000 operations minimum
<b>Electrical Life:</b>	1,000,000 operations minimum
<b>Nominal Operating Force:</b>	3.0N
<b>Total Travel:</b>	.030" (0.75mm)

## Materials & Finishes

<b>Actuator:</b>	Polycarbonate
<b>Case:</b>	Glass fiber reinforced polyamide
<b>Base:</b>	Glass fiber reinforced polybutylene terephthalate (PBT)
<b>Movable Contact:</b>	Stainless steel
<b>Stationary Contacts:</b>	Brass with silver plating
<b>Switch Terminals:</b>	Brass with silver plating
<b>Lamp Terminals:</b>	Brass with tin plating

## Environmental Data

<b>Operating Temperature Range:</b>	-25°C through +50°C (-13°F through +122°F)
<b>Humidity:</b>	90 ~ 95% humidity for 240 hours @ 40°C (104°F)
<b>Vibration:</b>	10 ~ 55Hz with peak-to-peak amplitude of 1.5mm traversing the frequency range & returning in 1 minute; 3 right angled directions for 2 hours
<b>Shock:</b>	50G (490m/s <sup>2</sup> ) acceleration (tested in 6 right angled directions, with 5 shocks in each direction)

## PCB Processing

<b>Soldering:</b>	Wave Soldering: See Profile A in Supplement section. Manual Soldering: See Profile A in Supplement section.
<b>Cleaning:</b>	These devices are not process sealed. Hand clean locally using alcohol based solution.

## Standards & Certifications

The JL Series tactiles have not been tested for UL recognition or CSA certification. These switches are designed for use in a low-voltage, low-current circuit. When used as intended, the results do not produce hazardous energy.

# Distinctive Characteristics

Bright, full face illumination with choice of red, green, or amber LEDs.

Multiple LED arrays and interior reflectors enhance illumination of the large, .75" (19mm) square actuator surface.

Distinctive design allows full face illumination in extra low profile of 0.31" (7.85mm) from PCB to top of switch.

Dome contact gives crisp tactile and audible feedback with short stroke and assures high reliability and long life of 1,000,000 operations.

Crimped terminals provide a spring type action to ensure secure mounting and prevent dislodging during the soldering process.

Streamlined housing dimensions provide for compact, side-by-side mounting on a standard grid.

Terminal spacing conforms to standard .100" (2.54mm) PCB grid.

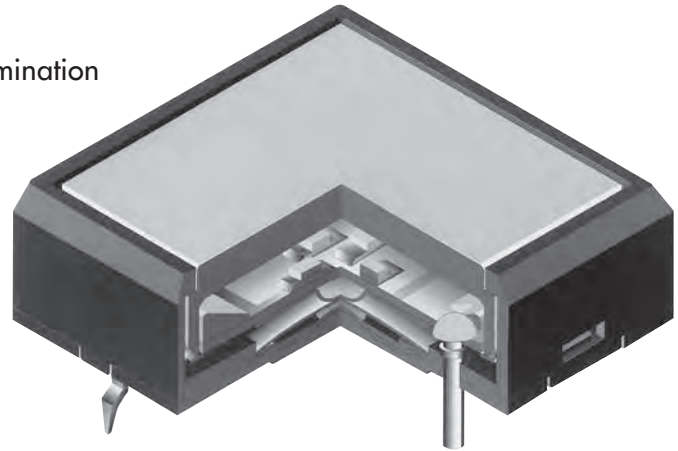

Actual Size



## Common Bus Matrix

These single pole, single throw switches can be used in a keyboard matrix and, using strapped terminals, achieve a common bus electrical configuration on a single-sided PC board.

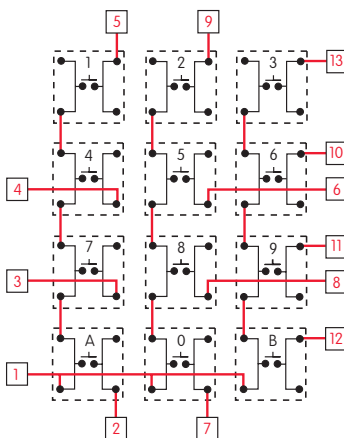

		PC Terminations												
		1	2	3	4	5	6	7	8	9	10	11	12	13
Keys (Switches)	1													
	2													
	3													
	4													
	5													
	6													
	7													
	8													
	9													
	0													
	A													
	B													

● = ON

## X-Y Matrix

These single pole, single throw switches can be arranged on a single-sided PC board matrix with strapped terminals to achieve an X-Y type electrical interconnection.

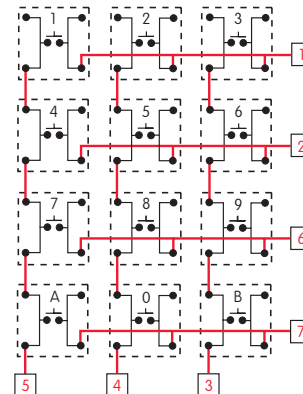

		PC Terminations						
		1	2	3	4	5	6	7
Keys (Switches)	1							
	2							
	3							
	4							
	5							
	6							
	7							
	8							
	9							
	0							
	A							
	B							

● = ON

Red = PCB Trace    Black = Switch Circuit

## TYPICAL SWITCH ORDERING EXAMPLE

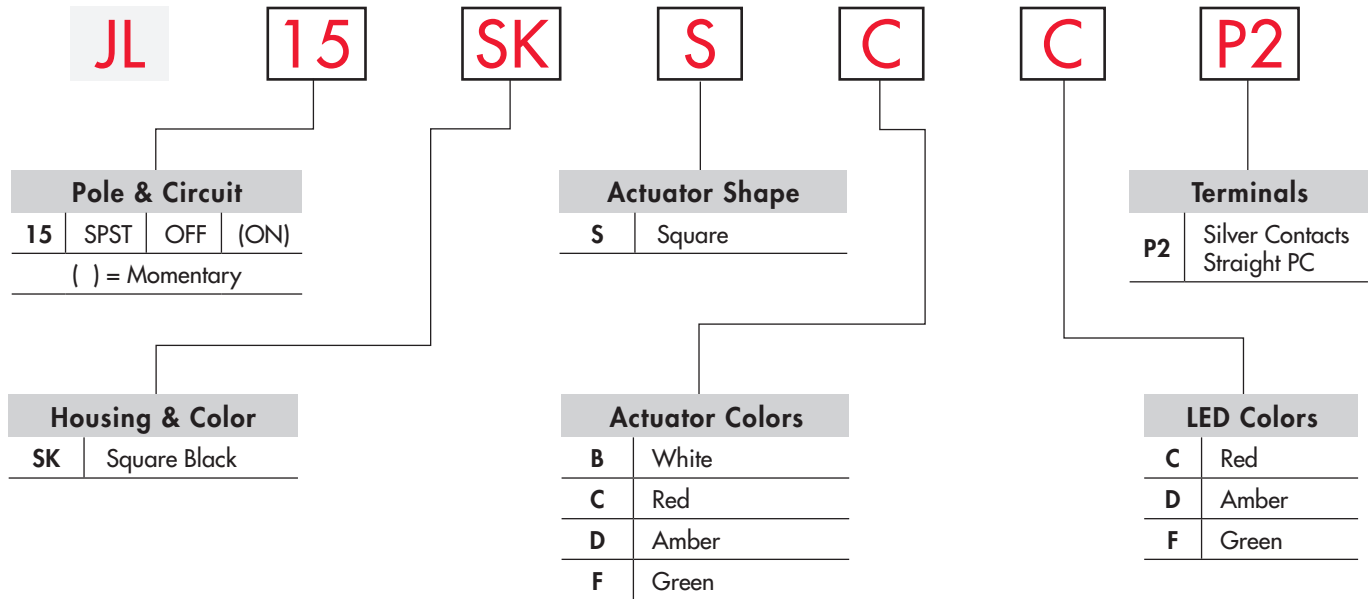

## DESCRIPTION FOR TYPICAL ORDERING EXAMPLE

**JL15SKSCP2**



## POLE & CIRCUIT

Pole	Model	Actuator Position ( ) = Momentary		Switch Throw & Schematic	LED Schematic	Note: Terminal markings "1", "1a", "-", and "+" are shown on the switch.
		Normal	Down			
SP	JL15	OFF	(ON)	SPST		

## HOUSING & COLOR

**SK** Square Black Housing

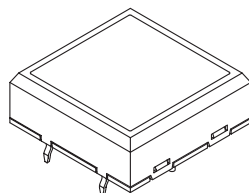

## ACTUATOR SHAPE & COLORS

**S** .748" (19.0mm) Square Actuator

Actuator Colors Available:

**B** White   **C** Red   **D** Amber   **F** Green

LED COLORS & SPECIFICATIONS

LEDs are an integral part of the switch. The electrical specifications shown are determined at a basic temperature of 25°C. If the source voltage exceeds the rated voltage, a ballast resistor is required. The resistor value can be calculated by using the formula in the Supplement.

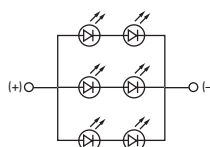
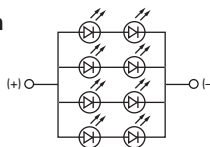
<b>Red LED model has 6 LEDs.</b> 	1-color, 1-element LEDs grouped in arrays of 6 or 8.	Color	<b>C</b> Red	<b>D</b> Amber	<b>F</b> Green
	<b>Amber &amp; Green models each have 8 LEDs.</b> 	Maximum Forward Current $I_{FM}$		90mA	120mA
	Typical Forward Current $I_F$		60mA	80mA	80mA
	Forward Voltage $V_F$		3.9V	4.0V	4.2V
	Maximum Reverse Voltage $V_{RM}$		10V	10V	10V
	Current Reduction Rate Above 25°C $\Delta I_F$		1.2mA/°C	1.6mA/°C	1.6mA/°C
	Ambient Temperature Range		-25°C ~ +50°C		

TERMINALS

**P2** Silver Contacts  
Straight PC

Additional details in  
Typical Switch Dimensions

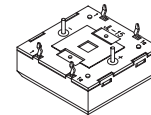

TYPICAL SWITCH DIMENSIONS

Square Actuator

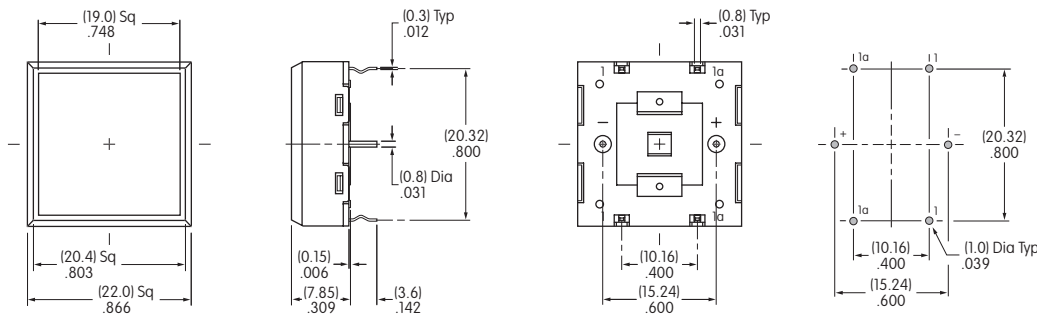

JL15SKSCCP2

LEGENDS

NKK Switches can provide custom legends for caps. Contact factory for more information.

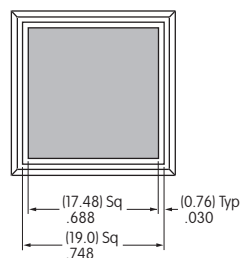
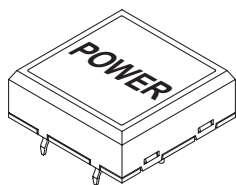

Shaded area is printable area.

Recommended Print Methods:

Screen Print or Pad Print.

Epoxy based ink is recommended.

Additional Method

Engraving is not recommended as an additional method for legends.

Contact factory if engraving is required; it must be done before the actuator is assembled.

# Notes

---

# Tilt Switches







# Distinctive Characteristics

## DSA

Environmentally friendly, contains no mercury.

High contact reliability due to sealed body.

The switch is triggered when tilted beyond  $\pm 10^\circ$  of the horizontal.

PCB adaptor available as an accessory.



## DSB

Photo interrupter, rather than contacts, ensures high reliability. 1 million operations minimum.

Sealed construction for protection from environmental elements, including hydrogen sulfide, sulfur dioxide, and nitrogen hydroxide. Terminals are made of ammonia-resistant materials.

Totally sealed body allows process compatibility for time- and money-saving automatic soldering and cleaning.

Space-saving compact dimensions allow high density mounting.

Internal steel ball movement allows functionality of  $360^\circ$  circumference rotation.

The DSB series switch is well-suited to meet product safety concerns due to normally closed (on) status.

Crimped terminals ensure secure mounting and prevent dislodging during wave soldering.

The switch is triggered when tilted beyond  $\pm 30^\circ$  of the horizontal.

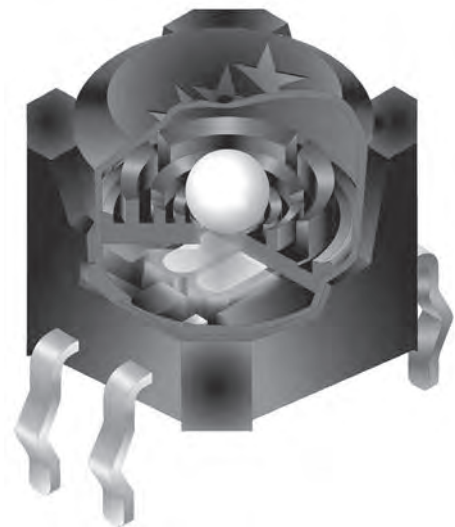

Actual Sizes

DSA

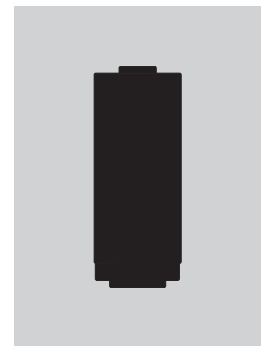

DSB

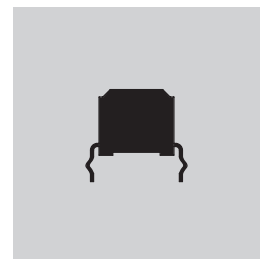

## DSA SWITCH PART NUMBER & DESCRIPTION



## DSA SWITCH SPECIFICATIONS

### Mechanical & Electrical Specifications

<b>Poles and Circuits:</b>	Single Pole Single Throw ON – OFF
<b>Operating Range:</b>	ON Angle = 10° ~ 170°; OFF Angle = 190° ~ 350°
<b>Resistive Load:</b>	0.1A @ 12V DC
<b>Contact Resistance:</b>	100 milliohms maximum
<b>Insulation Resistance:</b>	50 megohms minimum @ 250V DC
<b>Dielectric Strength:</b>	250V AC for 1 minute minimum between terminals
<b>Mechanical Life:</b>	100,000 operations minimum
<b>Electrical Life:</b>	100,000 operations minimum

### Materials & Finishes

<b>Housing:</b>	PBT
<b>Rubber Rings:</b>	Nitrile Butadiene Rubber
<b>Contact Balls:</b>	Brass with Silver Plating
<b>Terminals:</b>	Brass with Silver Plating

### Environmental Specifications

<b>Operating Temperature Range:</b>	-10°C ~ +70°C (+14°F ~ +158°F)
<b>Storage Temperature Range:</b>	-25°C ~ +85°C (-13°F ~ +185°F)
<b>Contact Bounce (for reference):</b>	500ms maximum
<b>Humidity:</b>	90% humidity for 96 hours @ 40°C (104°F)
<b>Vibration (for reference):</b>	Frequency range 10Hz ~ 500Hz for 2 hours; 2 directions; Acceleration: 0.2G
<b>Notes:</b>	<ol style="list-style-type: none"> <li>Do not install switch near vibration source.</li> <li>Terminals should not be exposed to liquid.</li> </ol>

### Processing for AT094 PCB Adaptor

<b>Soldering (with PCB Mount Holder):</b>	Wave Soldering: See Profile A in Supplement section. Manual Soldering: See Profile B in Supplement section.
<b>Automated Cleaning:</b>	Hand clean locally using alcohol based solution.

DSA SWITCH SPECIFICATIONS (CONTINUED)

Operating Range

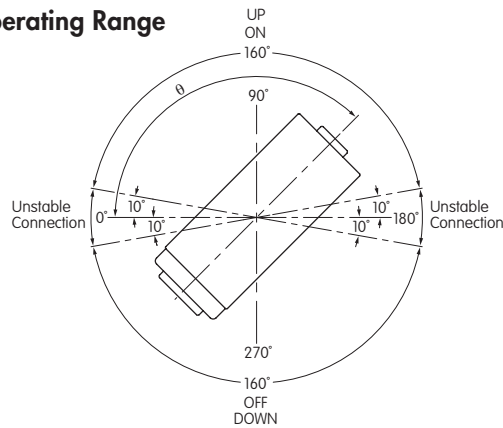

Cross Section

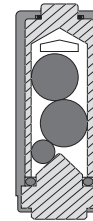

Allow 500ms settling time between states.

TYPICAL SWITCH DIMENSIONS

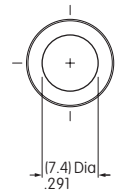
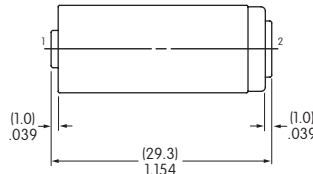
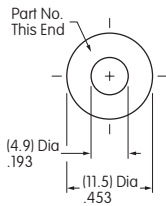

DSA01

Terminal numbers are not on the switch.

OPTIONAL ADAPTOR



AT094  
PCB Adaptor for DSA01

**Materials:**  
Holder: Polypropylene  
Spring: Spring Steel with Nickel Plating  
PC Pins: Brass with Nickel Plating



Assembled DSA Switch & Adaptor

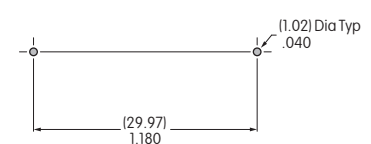
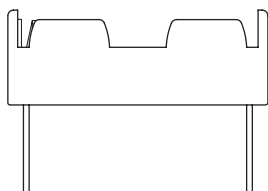
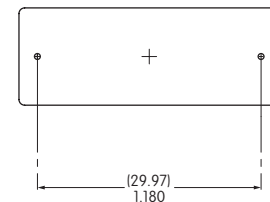
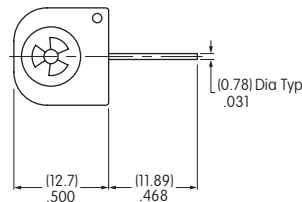
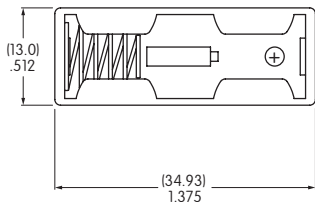

PCB Footprint

## DSB SWITCH PART NUMBERS & DESCRIPTION

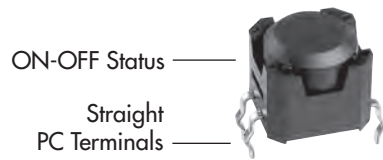

**DSBA1P**

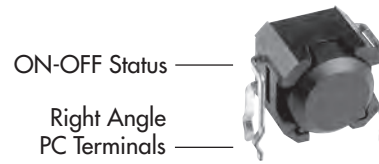

**DSBA1H**

## DSB SWITCH SPECIFICATIONS

### Absolute Maximum Ratings Temperature at 25°C

		Symbol	Rating	Unit
Input	Forward Current	$I_F$	50	mA
	Reverse Voltage	$V_R$	5	V
	Power Dissipation	$P_D$	75	mW
Output	Collector-Emitter Voltage	$V_{CEO}$	30	V
	Emitter-Collector Voltage	$V_{ECO}$	3	V
	Collector Current	$I_C$	20	mA
	Collector Power Dissipation	$P_C$	50	mW
	Total Power Dissipation	$P_{tot}$	100	mW

### Mechanical Specifications

<b>Mechanical Life:</b>	1,000,000 operations minimum
<b>Electrical Life:</b>	1,000,000 operations minimum using applicable circuit

### Materials & Finishes

<b>Housing:</b>	Glass fiber reinforced polyamide (UL94V-0 flammability rating)
<b>Base:</b>	Glass fiber reinforced polyamide (UL94V-0 flammability rating)
<b>Terminals:</b>	Phosphor bronze with tin plating

### Environmental Specifications

<b>Operating Temperature Range:</b>	-25°C ~ +80°C (-13°F ~ +176°F)
<b>Storage Temperature Range:</b>	-30°C ~ +85°C (-22°F ~ +185°F)
<b>Humidity:</b>	85% humidity for 500 hours @ +85°C (+185°F)
<b>Vibration:</b>	10Hz with peak-to-peak amplitude of 10mm traversing the frequency range & returning in 1 minute; 3 right angled directions for 500,000 cycles
<b>Shock:</b>	100G (981m/s <sup>2</sup> ) acceleration (tested in 6 right angled directions, with 5 shocks in each direction)
<b>Notes:</b>	<ol style="list-style-type: none"> <li>1. Prevent exposure to magnetic fields.</li> <li>2. Do not install switch near vibration source.</li> </ol>

DSB SWITCH SPECIFICATIONS (CONTINUED)

Operating Characteristics

	Operating Angle	Return Angle
<b>Circuit Characteristics (ON-OFF)</b>	$\pm 30^\circ$ to $\pm 60^\circ$	Minimum $10^\circ$
	Output $V_{OL} \rightarrow V_{OH}$	Output $V_{OH} \rightarrow V_{OL}$

Output Characteristics  $V_{OL}$  with Photo transistor ON: 1.0V maximum (horizontal)

Output Characteristics  $V_{OH}$  with Photo transistor OFF: 4.0V minimum (inclined at an angle of  $-60^\circ$  minimum)

Output Characteristics

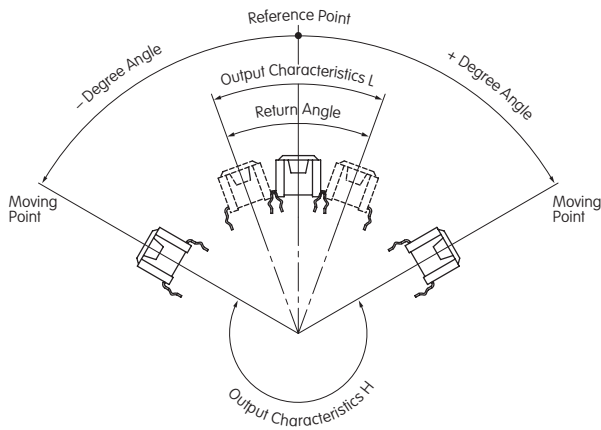

Straight PC

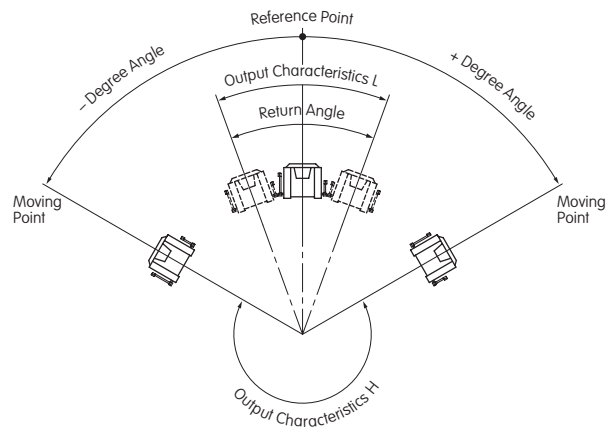

Right Angle PC

Circuit Design Considerations

$V_{CC} = 5V$   
 $R_2 = 100k\Omega$   
 $I_F = 19mA$  ( $V_{CC} = 5V, R_1 = 200\Omega$ )  
 $V_F$  of the LED Maximum = 1.3V

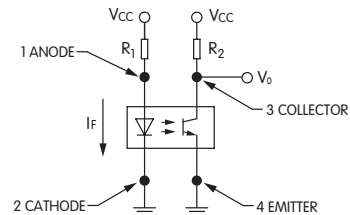

PCB Processing

**Soldering :** Wave Soldering: See Profile A in Supplement section.  
 Manual Soldering: See Profile A in Supplement section.

**Automated Cleaning:** Use alcohol based solution at  $50^\circ C$  maximum. Do not submerge over 2.0" (5.0cm) for 1 minute maximum. Do not use organic solvents.

## MOUNTING OPTIONS

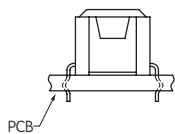

PCB mounting option for Straight PC

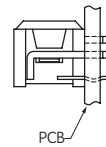

PCB mounting option for Right Angle PC

Install switch at an angle less than  $\pm 3^\circ$  from the mounting surface.

## TYPICAL SWITCH DIMENSIONS

### Straight PC

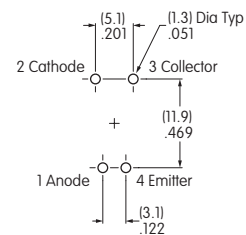
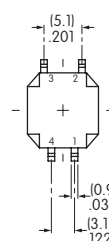
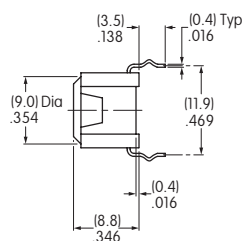
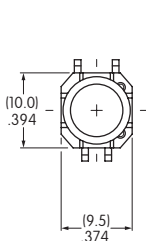

**DSBA1P**

Terminal numbers are on bottom of switch.

### Right Angle PC

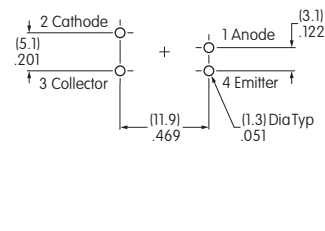
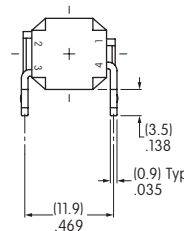
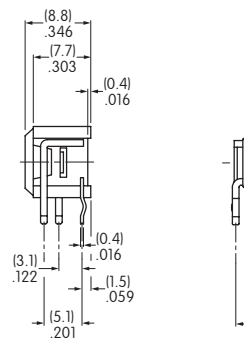
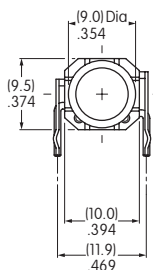

**DSBA1H**

Terminal numbers are on bottom of switch.

Toggles  
Rockers  
Pushbuttons  
Illuminated PB  
Programmable  
Keylocks  
Rotaries  
Slides  
Tactiles  
Tilt  
Touch  
Indicators  
Accessories  
Supplement



# Notes

---



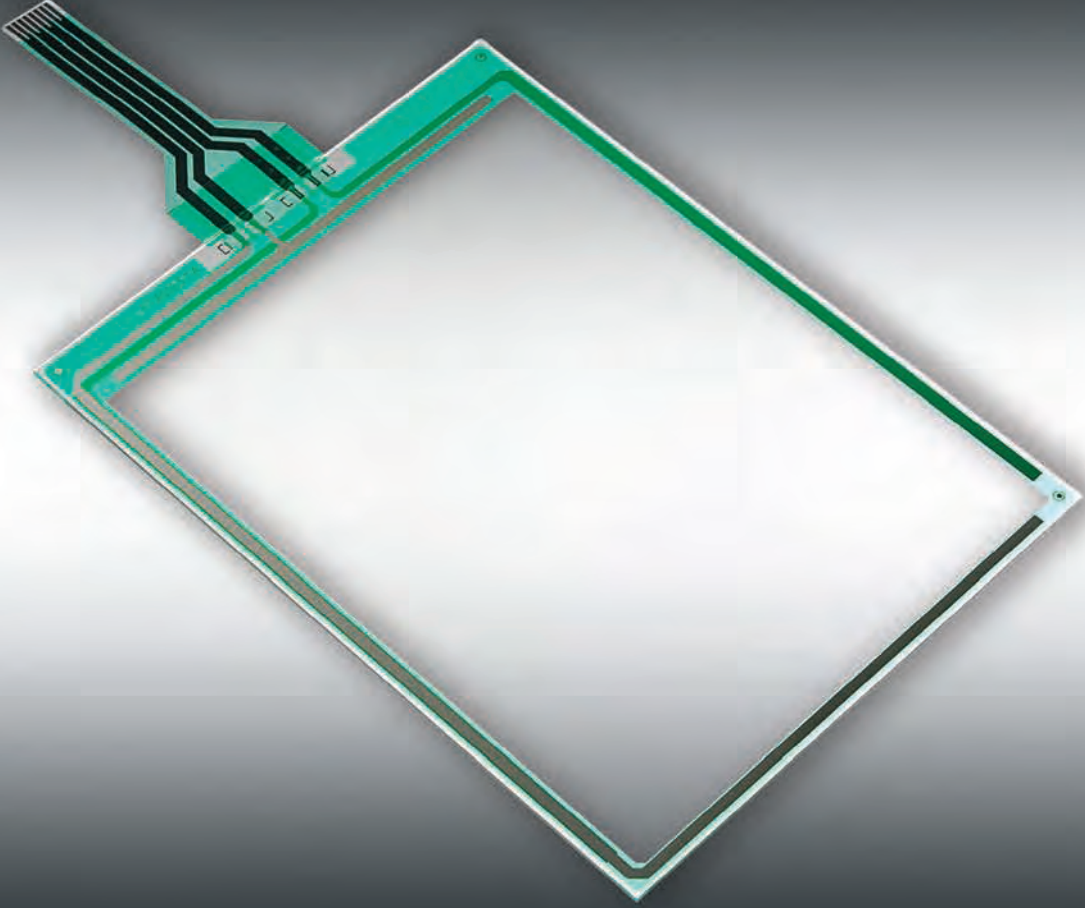

# Touch Screens & Membranes

Toggles

Rockers

Pushbuttons

Illuminated PB

Programmable

Keylocks

Rotaries

Slides

Tactiles

Tilt

Touch

Indicators

Accessories

Supplement

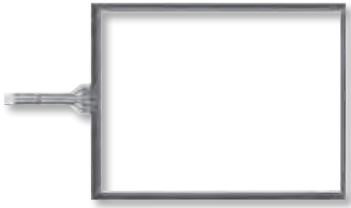

5-Wire Touchscreens.....L5

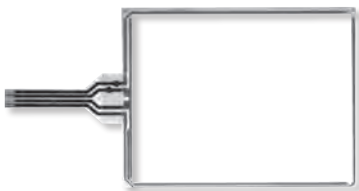

4-Wire Touchscreens.....L8

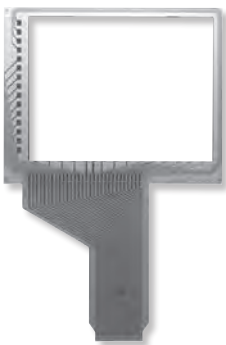

Digital Touchscreens.....L14



FM Membranes .....L15

# Resistive Touch Screens

## 5-Wire, 4-Wire & Digital Solutions

NKK's transparent touch screens are engineered to complement the application of choice while offering superior durability and flexibility. With options in multiple sizes, and choices of input by finger, gloved finger or stylus, we maintain a consistent focus on impeccable quality and value added solutions with the diverse needs of our customers at the forefront.

Whether an application requires the 5- or 4-wire technology, the features include metal tails (analog), contact reliability with a connector, and ANR film, eliminating many of the typical visual artifacts. The film surface is non-glare and hard coated for ease of use and integrity of the surface.

Additional benefits of NKK's 5-wire touch screens include:

- Screens highly resistant to static electricity and noise pollution
- Drift-free operation despite any temperature fluctuation
- Greater touch point density translating to more precision and reduction of false actuations
- Quicker response time

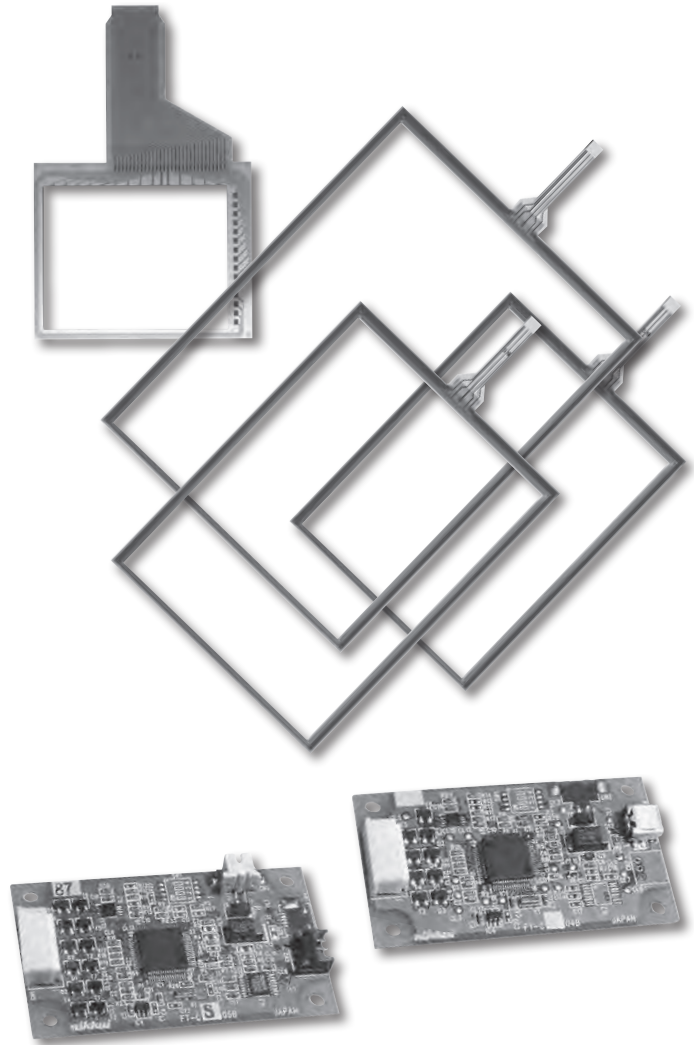

### DISTINCTIVE CHARACTERISTICS

- Wide Range of Available Sizes
- Custom Solutions a Specialty
- Digital and Analog Solutions
- Controllers Available
- Anti-Newton Ring (ANR) Technology for Analog Touch Screens
- Design Minimizes Visual Artifacts
- RoHS Compliant

### APPLICATIONS

- Information Kiosks
- Industrial Automation
- Banking, Exchange Management Systems
- Broadcast
- Office Automation
- Medical Equipment
- Hand-held Devices
- Hospitality and Restaurant
- Gaming

## Customization Options

Parameter	Notes & Options
Resistive Analog Touch Screen	4-Wire or 5-Wire
Integrate LCD & Touchscreen	Yes - No
5-Wire - Screen Size Diagonal Inches	Standard 10.4, 12.1, 15 (min 10.4, max 19)
4-Wire - Screen Size Diagonal Inches	Standard 5.7, 6.5, 8.4, 10.4, 12.1, 15 (min 2.5, max 19)
Data Entry Area mm x mm	Same as the dimensions of the display area of the LCD
Viewable Area mm x mm	Same as the dimensions of the bezel opening of the LCD
Perimeter Dimensions mm x mm	
Tail Type	PCB standard, FPC option
Tail Pitch	1.25mm is standard
Tail Pins	8 is standard, 4 is option
Tail Length	2 standard options: 65mm or 80mm
Tail Base Width	28.2mm is standard
Tail Location	Left side is standard, non-std options top or bottom
Tail Material	Carbon-coated silver is standard, option is copper-gold
Glass Thickness	1.1 and 1.8mm are standard (note: total thickness = glass thickness + 0.3mm)
Hardcoat Treatment	Standard
Anti-Newton Ring Treatment	Standard
Optical Transmission Factor	80% is standard
Controller	Yes - No (no = customer will supply)
Communication	USB or RS232
Operating System	Windows 7 or Windows XP

Toggles

Rockers

Pushbuttons

PB

Illuminated

Keylocks

Rotaries

Slides

Tactiles

Tilt

Touch

Indicators

Accessories

Supplement

## GENERAL SPECIFICATIONS FOR 5-WIRE

### 5-Wire Resistive Analog Touch Screens

Optical	
Light Transmission	80% standard
Film Options	Anti-glare, anti-Newton ring standard
Electrical	
Power Level	5.5V DC
X Y Resistive Value	20 ~ 80Ω
Insulation Impedance	10MΩ minimum @ 25V DC
Linearity	±2% maximum (after adjustment made by control board or device driver)
Chattering Time	10 milliseconds maximum
Mechanical	
Touch Activation Force	1.47N
Available Sizes	10.4", 12.1" and 15.0"
Durability	
Surface Hardness	2H (JIS K5600)
Expected Operational Life	Writing: 50,000 minimum operations (approximately 30mm movement with stylus)
	Tapping: 10,000,000 operations minimum (using silicon rubber)
Environmental	
Operating Temperature Range	-20°C ~ +70°C (-4°F ~ +158°F)
Storage Temperature Range	-40°C ~ +80°C (-22°F ~ +158°F)
Relative Humidity	+60°C (+140°F), humidity 90%, 240 hours

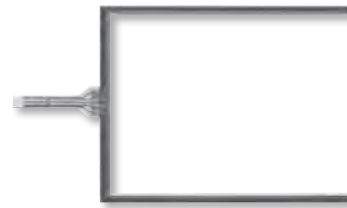

**FTAS00-104A5**



**FTAS00-121A5**

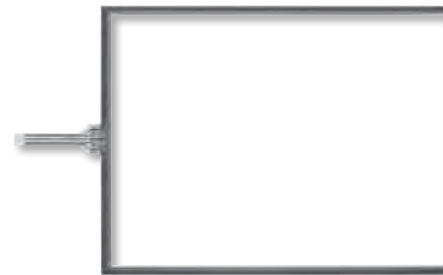

**FTAS00-150A5**

## PART NUMBERS & DESCRIPTIONS FOR 5-WIRE

### 5-Wire Analog Touch Screens

Part Number	Screen Size in Inches	Key Area Dimensions	Viewing Area Dimensions	External Dimensions	Panel Thickness	Terminal Detail 8 Pin .049" (1.25mm) Pitch
<b>FTAS00-104A5</b>	10.4	8.5" x 6.45" (215.9mm x 163.9mm)	8.66" x 6.61" (219.9mm x 167.9mm)	9.31" x 7.22" (236.5mm x 183.3mm)	.083" (2.1mm)	Length 3.15" (80.0mm)
<b>FTAS00-121A5</b>	12.1	9.8" x 7.37" (249.0mm x 187.2mm)	9.94" x 7.50" (252.4mm x 190.6mm)	10.52" x 8.1" (267.1mm x 205.8mm)	.083" (2.1mm)	Length 3.15" (80.0mm)
<b>FTAS00-150A5</b>	15.0	12.05" x 9.06" (306.1mm x 230.1mm)	12.19" x 9.19" (309.5mm x 233.5mm)	12.79" x 9.79" (324.8mm x 248.7mm)	.083" (2.1mm)	Length 3.15" (80.0mm)

Note: See web site for dimensioned drawings for all 5-Wire Analog Touch Screens.

## GENERAL SPECIFICATIONS FOR 5-WIRE

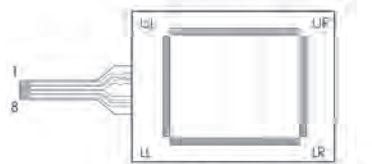
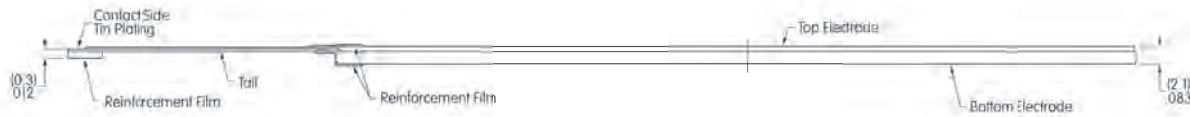
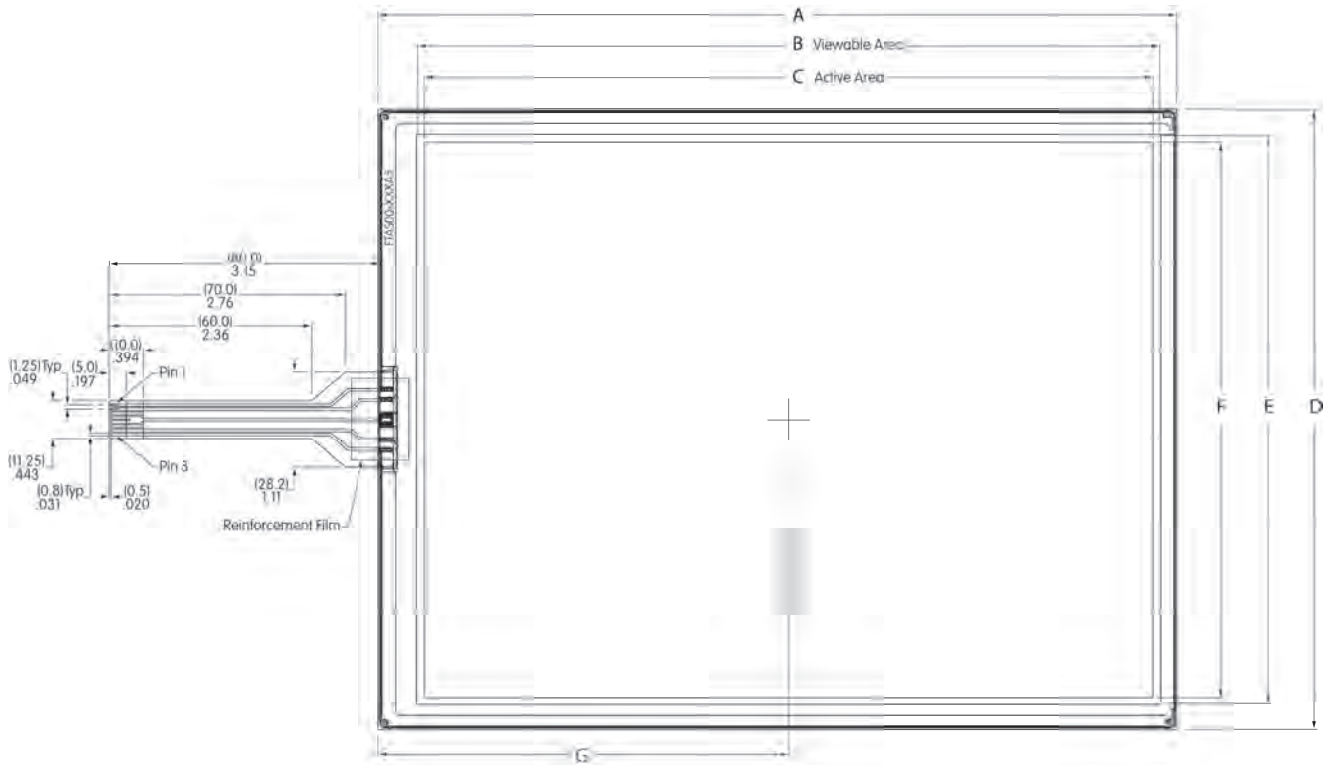

UL, LL, UR, LR: Bottom Electrode Terminal  
SENSE: Top Electrode Terminal

Pins	Signal
1	UR
2	UL
3	NC
4,5	SENSE
6	NC
7	LL
8	LR

### 5-Wire Analog Touch Screen Dimensions

Part Number	Screen Size in Inches	Dim A	Dim B Viewable Area	Dim C Active Area	Dim D	Dim E Viewable Area	Dim F Active Area	Dim G Center of Active Area
<b>FTAS00-104A5</b>	10.4	9.31 (236.5) +/-0.3	8.66 (219.9)	8.50 (215.9)	7.22 (183.3) +/-0.3	6.61 (167.9)	6.45 (163.9)	4.79 (121.55)
<b>FTAS00-121A5</b>	12.1	10.52 (267.1) +/-0.3	9.94 (252.4)	9.80 (249.0)	8.10 (205.8) +/-0.3	7.50 (190.6)	7.37 (187.2)	5.37 (136.4)
<b>FTAS00-150A5</b>	15.0	12.79 (324.8) +/-0.3	12.19 (309.5)	12.05 (306.1)	9.79 (248.7) +/-0.3	9.19 (233.5)	9.06 (230.1)	6.49 (164.95)

5-Wire Touch Screen Controller Boards & Drivers

**DISTINCTIVE CHARACTERISTICS**

- High Quality and Reliability
- Easy Integration Replacing Mouse Functionality
- Compatible with Control Board USB/RS232C
- Device Driver Compatible with Vista and Windows XP Operating Systems

Controller Boards Available for RS232C

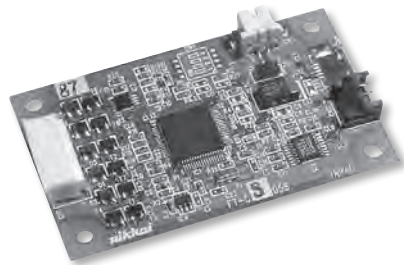

Controller Boards Available for USB

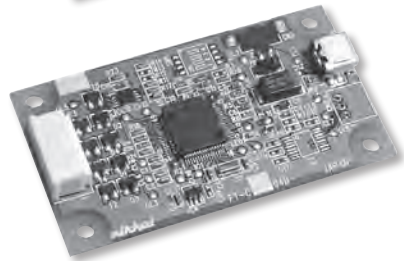

NKK offers controller boards compatible with USB or with RS232C. See web site or contact factory for specifications and technical data.

Controller Boards		
Type	Part No.	Communication Protocol
5-Wire	<b>FTCS05B</b>	RS232C
5-Wire	<b>FTCU05B</b>	USB

See web site for dimensioned drawings or technical data for any of the controller boards and drivers.

IC & Accessories

**DISTINCTIVE CHARACTERISTICS**

- Interface: USB and RS232C
- High Speed and Accuracy
- Built-in Calibration Function
- Data Function Removal Built In to Eliminate Noise

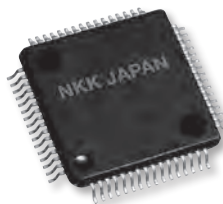

IC FTCSU564

The IC is for use with the 5- and 4-wire transparent touch screens, and is available for those who prefer to design their own controller boards. When the screen is touched, it recognizes the position of the touch by the level of analog voltage detected by the A/D. The A/D converter receives the value and sends a set of coordinate values as serial data or USB.

See web site or contact factory for IC specifications.

**OPTIONAL ACCESSORIES**

**AT713 Receptacle Connector**

This Receptacle Connector with code connects to RS232C communication of the controller boards.



**AT714 Receptacle Connector**

AT714 is a Receptacle Connector with code to connect to power source of the control boards.



For more details and dimensioned drawings of the accessories, go to the web site or call our engineering support personnel.

### GENERAL SPECIFICATIONS FOR 4-WIRE

#### 4-Wire Analog Resistive Touch Screens

Optical	
Light Transmission	Analog: 80% standard Digital: 78% standard
Film Options	Anti-glare, anti-Newton ring standard
Electrical	
Power Level	1mA @ 5V DC (resistive load)
Insulation Impedance	10MΩ minimum @ 25V DC
Linearity	3% maximum (analog)
Chattering Time	10 milliseconds maximum
Mechanical	
Touch Activation Force	1.4N maximum
Available Sizes	5.7" ~ 15" standard
Durability	
Surface Hardness	2H (JIS K5600)
Expected Operational Life	1,000,000 operations minimum
Environmental	
Operating Temperature Range	-10°C ~ +60°C (+14°F ~ +140°F)
Storage Temperature Range	-20°C ~ +70°C (-4°F ~ +158°F)
Relative Humidity	+60°C (+140°F), humidity 90%, 240 hours

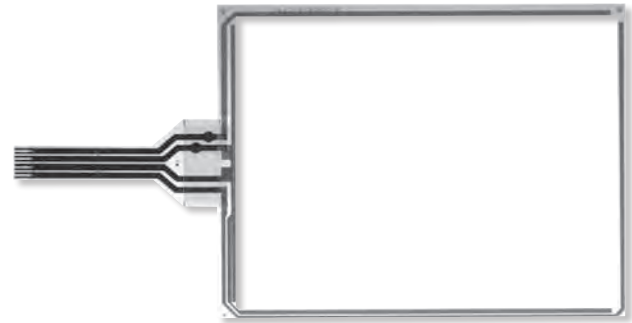

Analog  
FTAS00-57AS4

### PART NUMBERS & DESCRIPTIONS FOR 4-WIRE

4-Wire Analog Touch Screens						
Part Number	Screen Size in Inches	Key Area Dimensions	Viewing Area Dimensions	External Dimensions	Panel Thickness	* Terminal Detail 8 Pin .049" (1.25mm) Pitch
FTAS00-57AS4	5.7	4.54" x 3.40" (115.2mm x 86.4mm)	4.76" x 3.61" (121.0mm x 91.6mm)	5.16" x 3.98" (131.0mm x 101.0mm)	.055" (1.4mm)	Length 2.56" (65.0mm)
FTAS00-65AS4	6.5	5.20" x 3.90" (132.0mm x 99.0mm)	5.43" x 4.13" (138.0mm x 105.0mm)	5.91" x 4.57" (150.0mm x 116.0mm)		Length 2.56" (65.0mm)
FTAS00-84AS4	8.4	6.73" x 5.10" (170.9mm x 129.6mm)	6.95" x 5.33" (176.5mm x 135.4mm)	7.34" x 5.69" (186.5mm x 144.4mm)	.083" (2.1mm)	Length 3.15" (80.0mm)
FTAS00-104AS4	10.4	8.32" x 6.24" (211.2mm x 158.4mm)	8.47" x 6.39" (215.0mm x 162.4mm)	8.88" x 6.75" (225.6mm x 171.4mm)		Length 3.15" (80.0mm)
FTAS00-104AV4	10.4	8.35" x 6.28" (212.2mm x 159.4mm)	8.52" x 6.43" (216.4mm x 163.4mm)	8.92" x 7.21" (226.5mm x 183.0mm)		Length 3.15" (80.0mm)
FTAS00-121A4	12.1	9.72" x 7.30" (246.76mm x 185.32mm)	10.04" x 7.53" (255.0mm x 191.32mm)	10.67" x 8.07" (271.0mm x 205.0mm)		Length 3.15" (80.0mm)
FTAS00-121AS4	12.1	9.69" x 7.26" (246.0mm x 184.5mm)	9.84" x 7.42" (250.0mm x 188.5mm)	10.28" x 7.80" (261.0mm x 198.0mm)		Length 3.15" (80.0mm)
FTAS00-150A4	15.0	12.05" x 9.06" (306.1mm x 230.1mm)	12.21" x 9.25" (310.0mm x 235.0mm)	12.91" x 9.84" (328.0mm x 250.0mm)	Length 3.15" (80.0mm)	

Note: Input methods are finger or stylus.

\* 4 pin available with 1.0mm or 1.25mm pitch. Contact factory for details.



4-Wire with Horizontal Tail

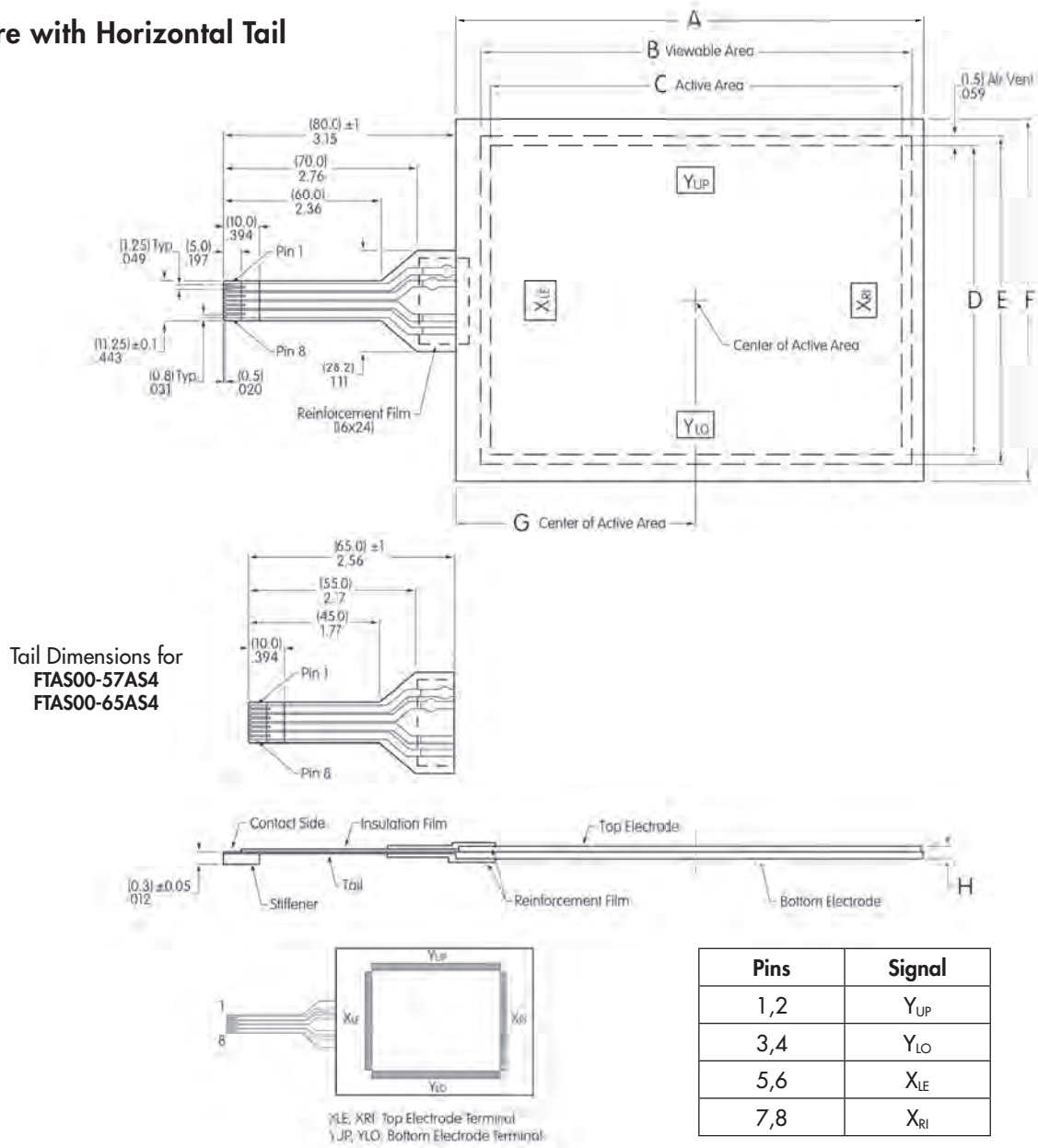

4-Wire Analog Touch Screen Dimensions									
Part Number	Screen Size in Inches	Dim A	Dim B Viewable Area	Dim C Active Area	Dim D	Dim E Viewable Area	Dim F Active Area	Dim G Center of Active Area	Dim H
FTAS00-57AS4	5.7	5.16" (131±0.3mm)	4.76" (121mm)	4.54" (115.2mm)	3.40" (86.4mm)	3.61" (91.6mm)	3.98" (101±0.3mm)	2.65" (67.25mm)	.055" (1.4mm)
FTAS00-65AS4	6.5	5.91" (150±0.3mm)	5.43" (138mm)	5.20" (132mm)	3.90" (99mm)	4.13" (105mm)	4.57" (116±0.3mm)	3.03" (77mm)	.055" (1.4mm)
FTAS00-84AS4	8.4	7.34" (186.5±0.3mm)	6.95" (176.5mm)	6.73" (170.9mm)	5.10" (129.6mm)	5.33" (135.4mm)	5.69" (144.4±0.3mm)	3.73" (94.85mm)	.083" (2.1mm)
FTAS00-104AS4	10.4	8.88" (225.6±0.3mm)	8.46" (215mm)	8.31" (211.2mm)	6.24" (158.4mm)	6.39" (162.4mm)	6.75" (171.4±0.3mm)	4.49" (114.1mm)	.083" (2.1mm)
FTAS00-121AS4	12.1	10.28" (261±0.3mm)	9.84" (250mm)	9.69" (246mm)	7.26" (184.5mm)	7.42" (188.5mm)	7.80" (198±0.3mm)	5.18" (131.6mm)	.083" (2.1mm)
FTAS00-150A4	15.0	12.91" (328±0.3mm)	12.20" (310mm)	12.05" (306.1mm)	9.06" (230.1mm)	9.25" (235mm)	9.84" (250±0.3mm)	6.52" (165.6mm)	.083" (2.1mm)

Toggles  
Rockers  
Pushbuttons  
Illuminated PB  
Programmable  
Key locks  
Rotaries  
Slides  
Tactiles  
Tilt  
Touch  
Indicators  
Accessories  
Supplement

## 4-Wire with Vertical Tail

FTAS00-104AV4

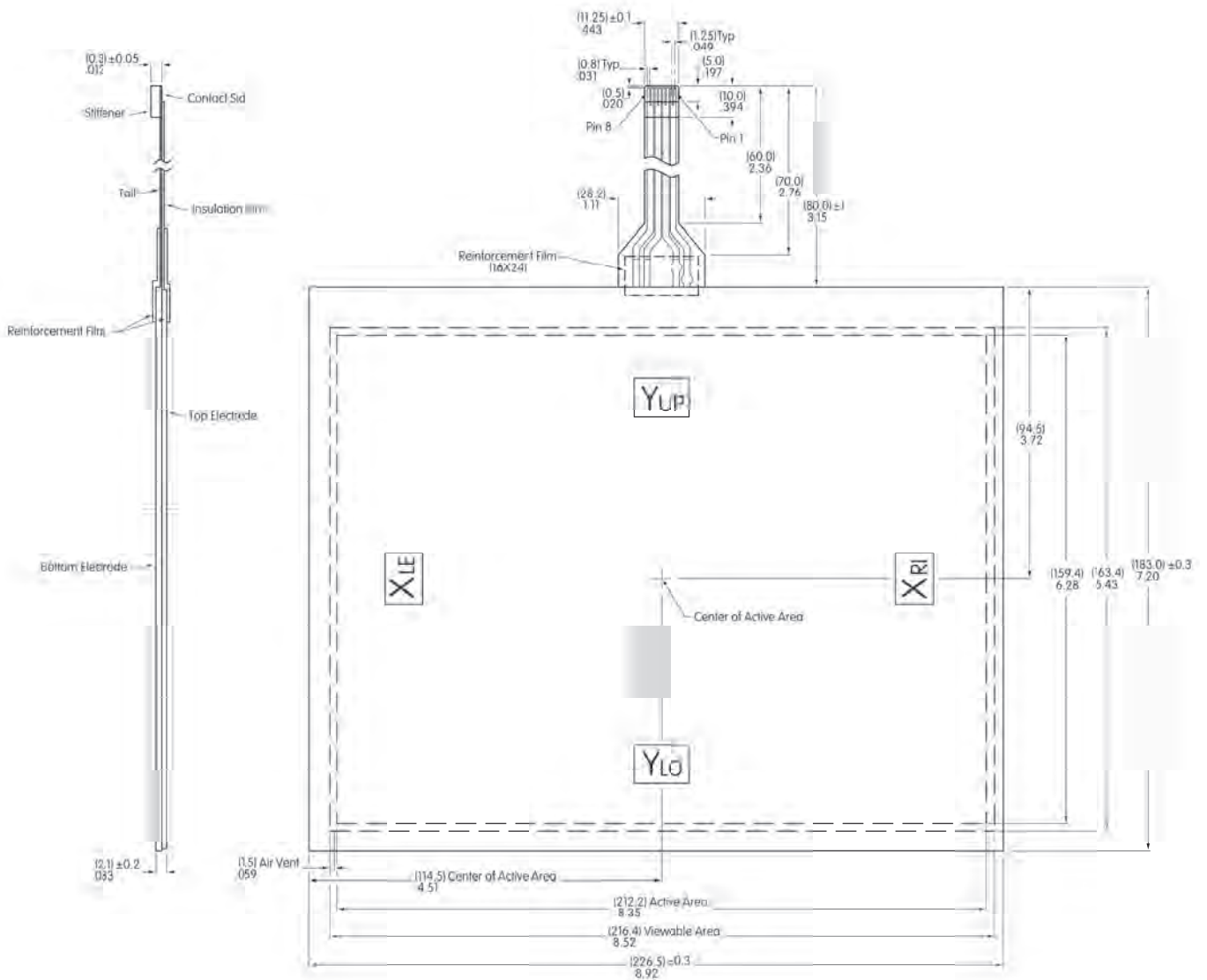

Pins	Signal
1, 2	Y <sub>UP</sub>
3, 4	Y <sub>LO</sub>
5, 6	X <sub>RI</sub>
7, 8	X <sub>LE</sub>

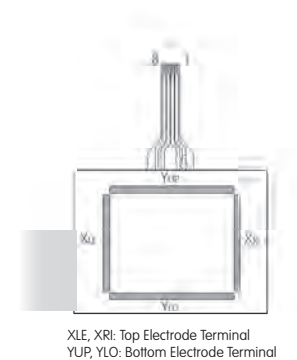

Toggles

Rockers

Pushbuttons

Illuminated PB

Programmable

Keylocks

Rotaries

Slides

Tactiles

Tilt

Touch

Indicators

Accessories

Supplement

4-Wire with Horizontal Tail (Off-Center)

FTAS00-121A4

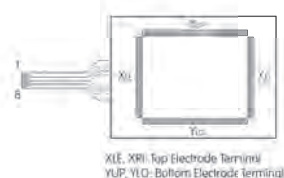
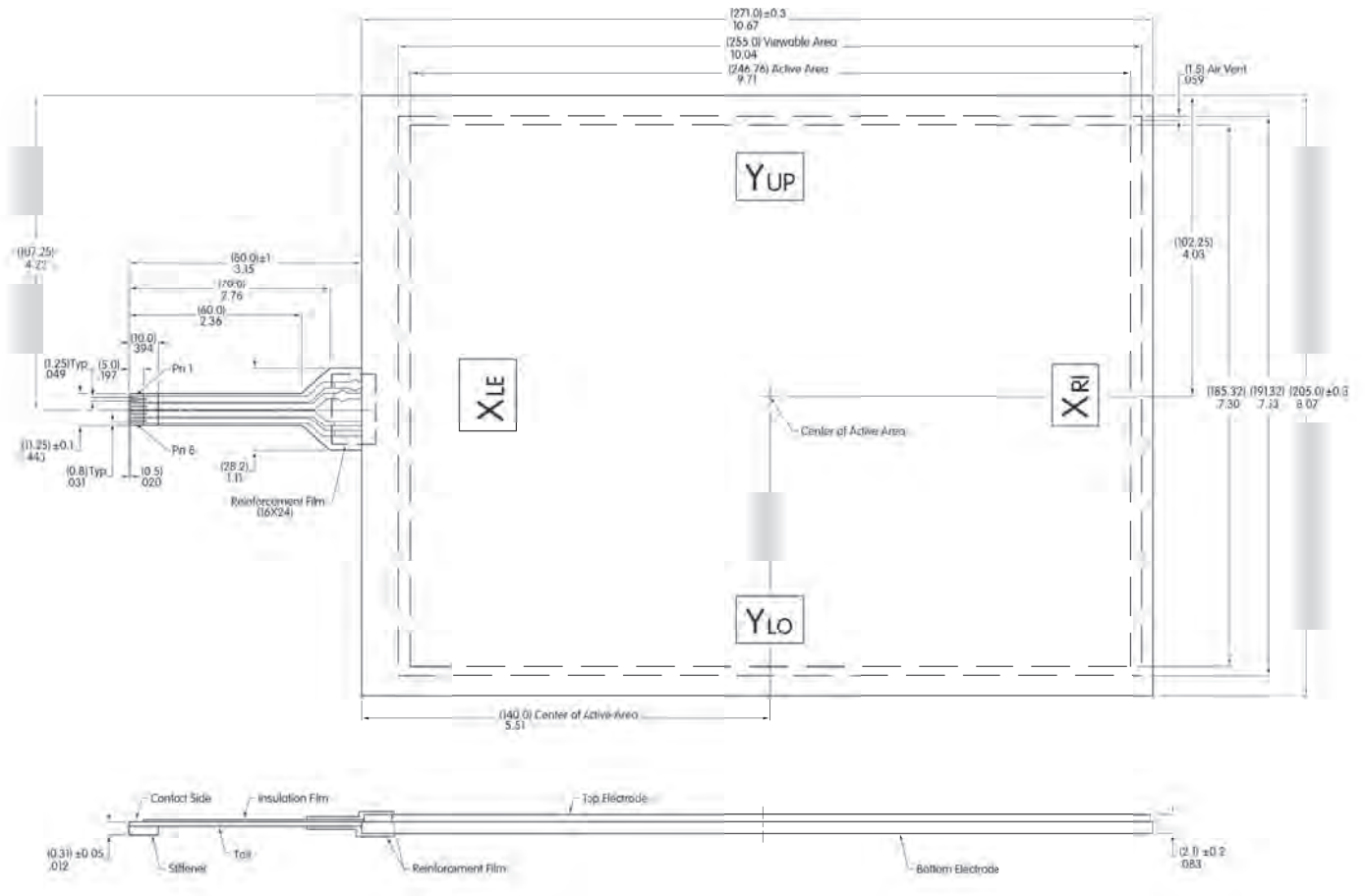

Pins	Signal
1, 2	Y <sub>UP</sub>
3, 4	Y <sub>LO</sub>
5, 6	X <sub>LE</sub>
7, 8	X <sub>RI</sub>

Toggles  
Rockers  
Pushbuttons  
Illuminated PB  
Programmable  
Keylocks  
Rotaries  
Slides  
Tactiles  
Tilt  
Touch  
Indicators  
Accessories  
Supplement

### 4-Wire Touch Screen Controller Boards & Drivers

#### DISTINCTIVE CHARACTERISTICS

- High Quality and Reliability
- Easy Integration Replacing Mouse Functionality
- Compatible with Control Board USB/RS232C
- Device Driver Compatible with Vista and Windows XP Operating Systems

#### Controller Boards Available for RS232C

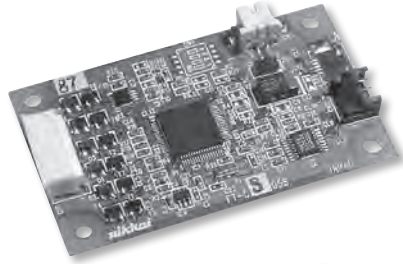

#### Controller Boards Available for USB

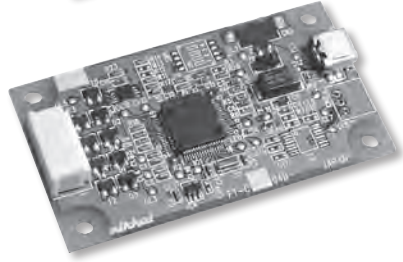

NKK offers controller boards compatible with USB or with RS232C. See web site or contact factory for specifications and technical data.

Controller Boards		
Type	Part No.	Communication Protocol
4-Wire	<b>FTCS04B</b>	RS232C
4-Wire	<b>FTCU04B</b>	USB

See web site for dimensioned drawings or technical data for any of the controller boards and drivers.

### IC & Accessories

#### DISTINCTIVE CHARACTERISTICS

- Interface: USB and RS232C
- High Speed and Accuracy
- Built-in Calibration Function
- Data Function Removal Built In to Eliminate Noise



IC FTCSU564

The IC is for use with the 5- and 4-wire transparent touch screens, and is available for those who prefer to design their own controller boards. When the screen is touched, it recognizes the position of the touch by the level of analog voltage detected by the A/D. The A/D converter receives the value and sends a set of coordinate values as serial data or USB.

See web site or contact factory for IC specifications.

#### OPTIONAL ACCESSORIES

##### AT713 Receptacle Connector

This Receptacle Connector with code connects to RS232C communication of the controller boards. It is compatible with FTCS04A and FTCS04A2.



##### AT714 Receptacle Connector

AT714 is a Receptacle Connector with code to connect to power source of the control boards.



For more details and dimensioned drawings of the accessories, go to the web site or call our engineering support personnel.

Toggles  
Rockers  
Pushbuttons  
Illuminated PB  
Programmable  
Keylocks  
Rotaries  
Slides  
Tactiles  
Tilt  
Touch  
Indicators  
Accessories  
Supplement

## Storage, Handling & Installation

Below are some general precautions for the 5-wire & 4-wire touch screen devices. Please check web site for complete documentation.

### Installation (4-wire, 5-wire)

- Do not pull on the tail. Do not apply stress to the tail area.
- Avoid vibration or shock.
- The touch screen mounting should not be loose.
- Ensure there are no burrs around the edges of the case or housing that can cause false actuation. The edges of the case or housing should not enter the keying area.
- The case or housing and upper electrode should have a space of about 0.5 mm to accommodate expansion or shrinkage due to humidity variances. If a shock barrier is used do not press hard on the upper electrode area. Any shock barrier should be installed more than 0.6 mm above the screen.
- To secure the touch screen, secure the lower portion with an item such as the LCD display panel. Do not secure the upper electrode with double-sided tape or similar items to avoid stress that can damage the upper or lower electrode.
- In order to balance upper and lower pressure, an air vent may be installed. Ensure that no liquid or oil will enter into the device.

### Handling Precautions (4-wire, 5-wire)

- When opening product, take precaution with up/down and front/back directions. Glass edges are not chamfered, corners or edges can be sharp. Wear gloves when handling the product.
- Do not pick up the product by the tail or pull the tail area.
- Use gloves or finger cots to prevent fingerprints on surface.
- When handling the product, hold it outside of the viewing area.
- Avoid stacking multiple products or placing other items on the product.
- Remove protective film after installation is completed.

### Operating Precautions (4-wire, 5-wire)

- Only operate with fingers or a touch screen stylus.
- Do not press hard with pen or similar objects between viewing area and key area.

### Design Precautions (4-wire, 5-wire)

- With analog type, resistive value change can dislocate the input area. Input area can be calibrated with software.
- When installing on top of a LCD, noise from the display device can create misoperation. To avoid noise, implement actions such as grounding the display device frame.
- Do not create software for simultaneous touch points as analog type will read the center point between two touch points.
- When used to draw a line, analog type will have a break at dot spacer. Compensate for this with software.

### Other Precautions (4-wire, 5-wire)

- Clean with a soft cloth and ethanol. Do not use any cleaning agents other than ethanol.
- Store product in original package and store at the temperature and humidity range specified.
- Do not store in an environment with acids or other corrosive gases or dew.
- Not suited for use in critical control systems such as nuclear power, aerospace, medical or transportation equipment, without proper failsafe design consideration.

### Handling Precautions (5-wire)

- NKK warrants the 5-wire touch panel when it is used with the NKK control board and driver. Do not use third party control boards.
- 5-wire devices can misalign cathode position or touch position even after calibration. See web site for details.
- Create a larger input area. If you have the input button at the edge of a screen, it might not operate properly.
- Complete 9 point calibration with NKK driver. If more precision is desired, 25 point calibration is recommended.

### Handling of Controller Board (5-wire)

- Warranty for one year after delivery. We do not warranty the controller board unless used with NKK touch panel.
- Use arc prevention to protect device from static electricity.
- Power source should be activated after host and touch panel are connected.
- When inserting connector CN1 and touch panel tail, be sure the slider of connector CN1 is pulled. Do not pull more than 10 times.
- Do not alter the product.
- Do not use any commands other than the ones specified in specifications.
- Place the product away from noise source (such as inverter from LCD operation) since tail can be affected by noise.
- If device driver (USB) does not work after installation, reboot the host computer while connected to the controller board.
- This product does not support suspended mode (USB).
- Protocol of USB transmission is one frame per one transaction.
- Contact factory if not using protocol above.

Toggles

Rockers

Pushbuttons

Programmable Illuminated PB

Keylocks

Rotaries

Slides

Tactiles

Tilt

Touch

Indicators

Accessories

Supplement

## Digital Touch Screen

Part Number	Screen Size in Inches	Key Area Dimensions	Viewing Area Dimensions	External Dimensions	Panel Thickness	Terminal Detail 30 Pin .039" (1.0mm) Pitch
<b>FTAS225-57AN</b>	5.7	4.54" x 3.39" (115.2mm x 86.04mm)	4.80" x 3.62" (122.0mm x 92.0mm)	5.51" x 4.45" (140.0mm x 113.0mm)	.083" (2.1mm)	Length 3.94" (100.0mm)

Notes: Input method is finger. Number of keys for Digital Touch Screen: 15 x 15. See web site for dimensioned drawings for the Digital Touch Screen.

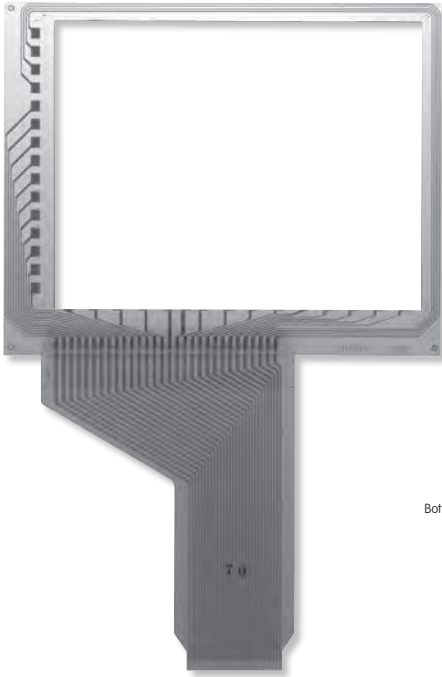

**Digital  
FTAS225-57AN**

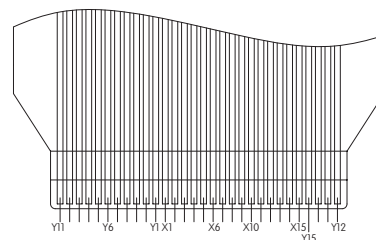
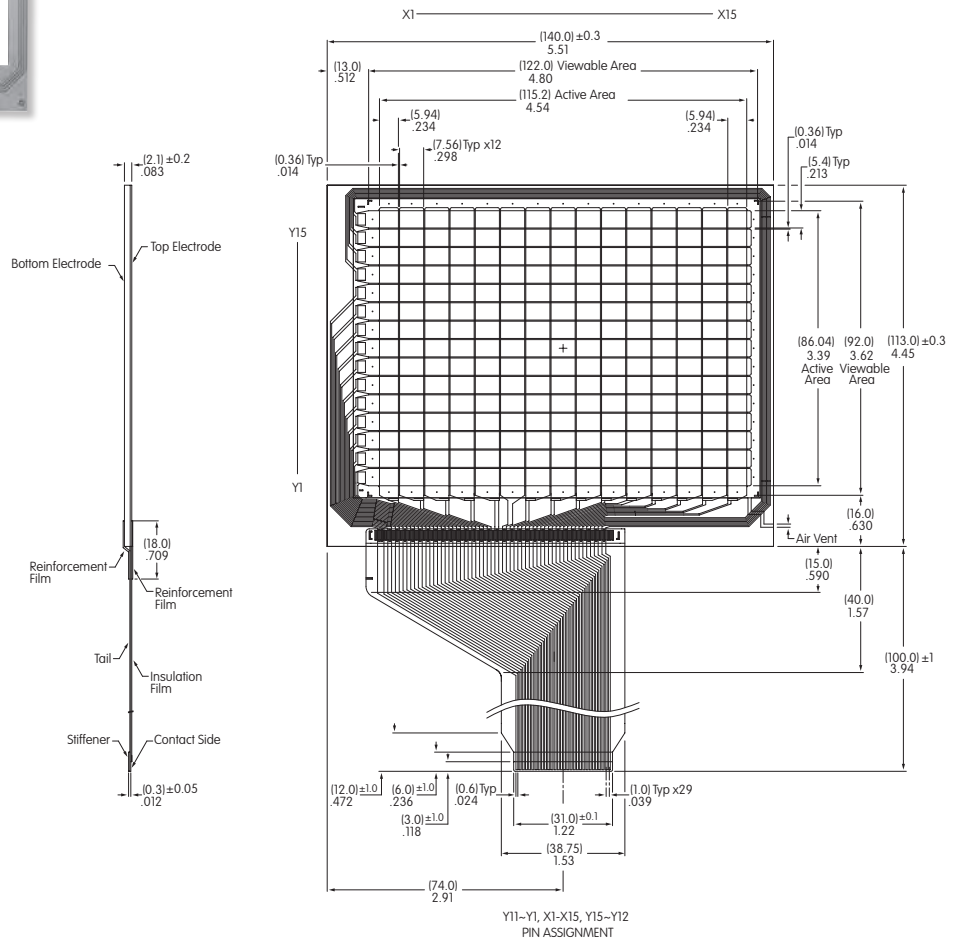

Y11-Y1, X1-X15, Y15-Y12  
PIN ASSIGNMENT

## DISTINCTIVE CHARACTERISTICS

- Nonilluminated options in 4 or 16 keys, illuminated choices in 12 or 16 keys
- 1.0mm (.039") tail pitch
- Easily integrated into designs: replaces multiple mechanical switches, soldered wires and cable assemblies
- Card insertion into design supports customized legends for nonilluminated models
- Actuating dome offers crisp, tactile feedback to positively indicate circuit transfer
- Illuminated models feature legends on embossed keypads
- Adhesive backing for easy mounting

## GENERAL SPECIFICATIONS

Power Level	20mA @ 24V DC
Contact Resistance	500Ω maximum (10mA @ 10V DC)
Insulation Resistance	100 megohms minimum @ 250V DC minimum
Dielectric Strength	250V AC minimum for one minute minimum
Operational Life	1,000,000 operations minimum
Contact Timing	10 milliseconds maximum
Nominal Operating Force	1.0N ~ 6.0N
Stroke:	
Nonilluminated	.016" ~ .039" (0.4mm ~ 1.0mm)
Illuminated with Overlay	.020" ~ .047" (0.5mm ~ 1.2mm)
Operating Temperature Range	-15°C ~ +50°C (+5°F ~ +122°F) illuminated
	-15°C ~ +55°C (+5°F ~ +131°F) nonilluminated

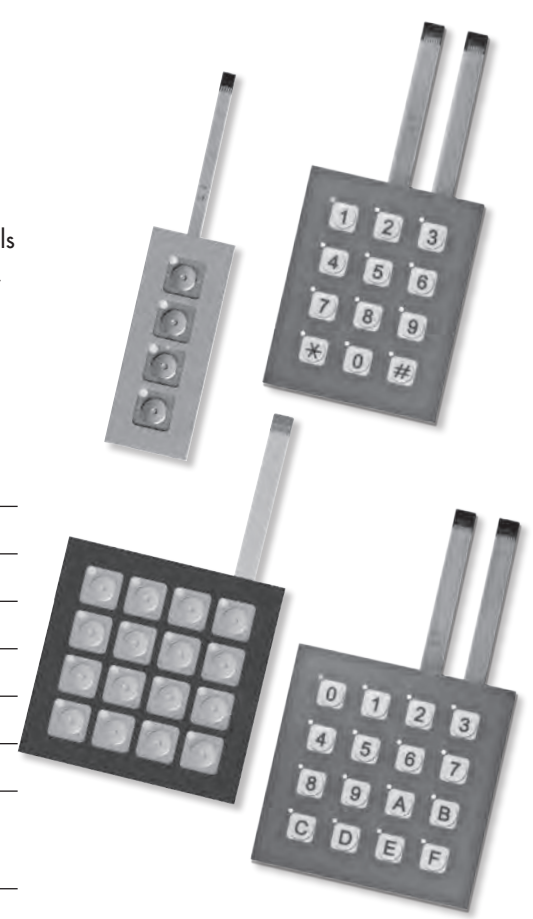

Toggles  
Rockers  
Pushbuttons  
Illuminated PB  
Programmable  
Keylocks  
Rotaries  
Slides  
Tactiles  
Tilt  
Touch  
Indicators  
Accessories  
Supplement

## LED SPECIFICATIONS

Single Element LED Color: Amber		Unit	
Forward Voltage (Typical)	V <sub>F</sub>	2.1	V
Forward Current (Typical)	I <sub>F</sub>	20	mA
Forward Current (Maximum)	I <sub>F</sub>	30	mA
* Forward Peak Current (Max)	I <sub>FM</sub>	195	mA
Reverse Voltage (Maximum)	V <sub>R</sub>	5.0	V

The electrical specifications shown are determined at a basic temperature of 25°C. LED is an integral part of the switch. LEDs are not sold separately.

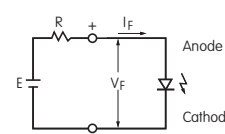

$$R = \frac{E - V_F}{I_F}$$

Where: R = Resistor Value (Ohms)  
E = Source Voltage (V)  
V<sub>F</sub> = Forward Voltage (V)  
I<sub>F</sub> = Forward Current (A)

LED circuits are isolated and require an external power source. If the source voltage exceeds the rated voltage, a ballast resistor is required.

\* Note: Pulse width 0.1msec maximum with a maximum duty cycle ratio of 1/10

Ordering Information		Description			
Part Number	Illumination	Number of Keys	Surface Sheet		Overlay
			Black (D)	Gray (E)	
<b>FMBN04BD</b>	Nonilluminated	4	•		
<b>FMBN04BE</b>		4		•	
<b>FMBN16BD</b>		16	•		
<b>FMBN16BE</b>		16		•	
<b>FMBP12BF</b>	Dot Illuminated with Overlay	12			Gray Surface Sheet with Embossed White Keypad and Gray Legends
<b>FMBP16BF</b>		16			

Toggles

Rockers

Pushbuttons

Illuminated PB

Programmable

Keylocks

Rotaries

Slides

Tactiles

Tilt

Touch

Indicators

Accessories

Supplement

## TYPICAL SWITCH DIMENSIONS

Nonilluminated • 4 or 16 Keys

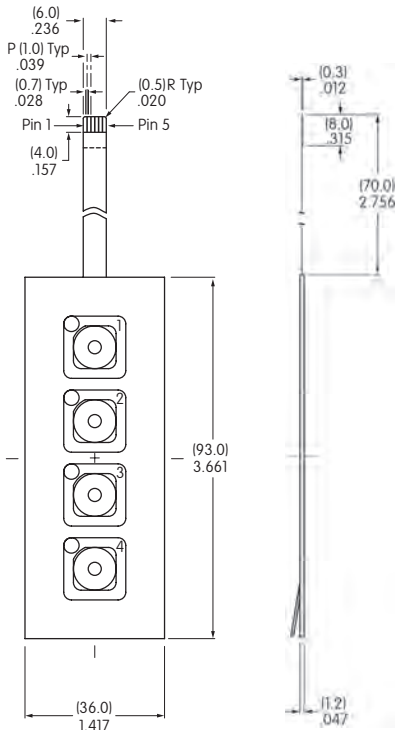

Switch Circuit Matrix For 4 Key

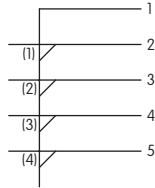

Key numbers in parenthesis are not actually on panel and are for reference only

Switch Circuit Matrix Detail For 4 or 16 Key

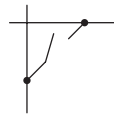

Switch Circuit Matrix For 16 Key

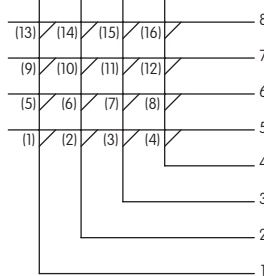

Key numbers in parenthesis are not actually on panel and are for reference only

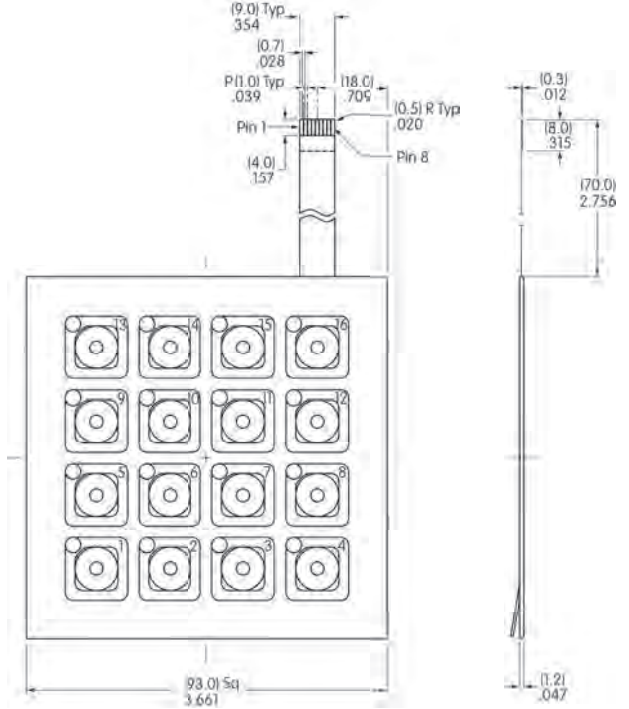

**FMBN04BE**  
Gray  
Surface  
Sheet

**FMBN16BD**  
Black  
Surface  
Sheet

Insertable Legend Card for 4 Key or 16 Key

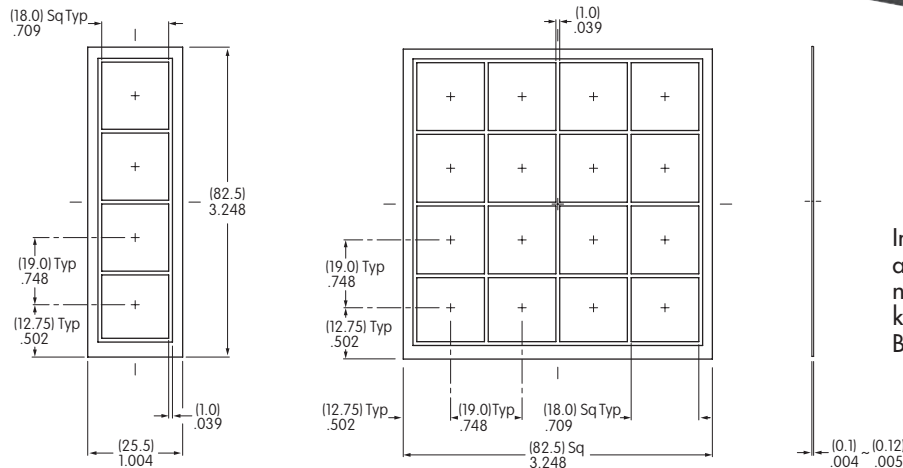

Insertable Legend Cards are supplied with the nonilluminated switch keypad assembly in Black, Gray and Yellow



TYPICAL SWITCH DIMENSIONS

Illuminated • 12 or 16 Keys

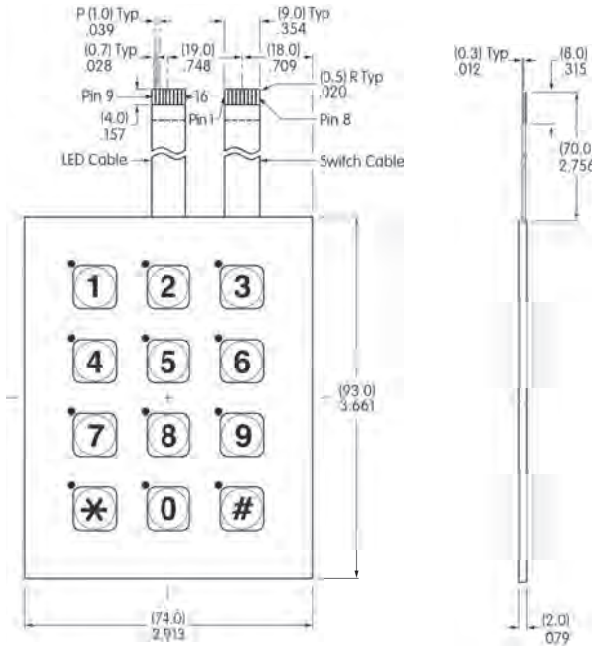

Dot illumination at upper left corner of each keypad

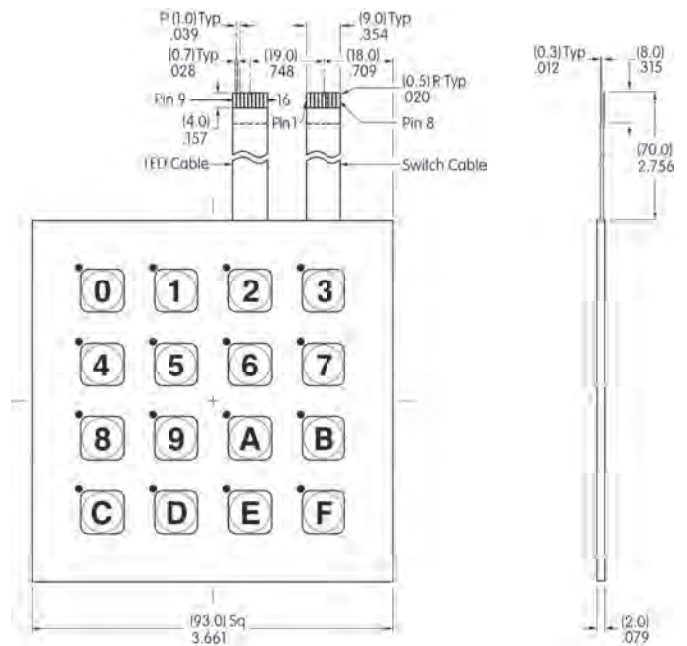

Dot illumination at upper left corner of each keypad

Switch Circuit Matrix For 12 Key

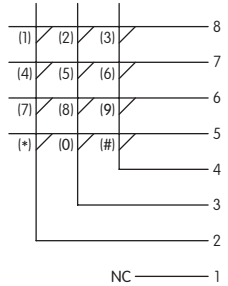

LED Circuit Matrix For 12 Key

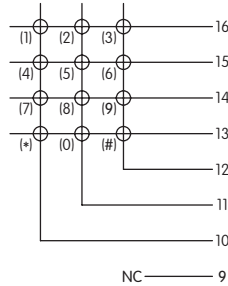

Switch Circuit Matrix For 16 Key

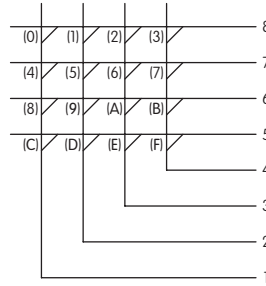

LED Circuit Matrix For 16 Key

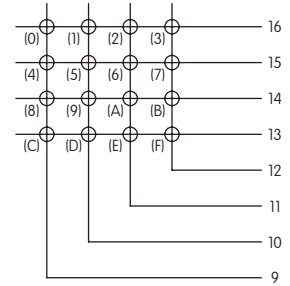

Key numbers in parenthesis are not actually on panel and are for reference only

FMBP12BF



Switch Circuit Matrix Detail For 12 or 16 Key

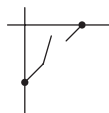

FMBP16BF



LED Circuit Matrix Detail For 12 or 16 Key

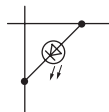

## INSERTABLE LEGEND CARDS

### Instructions for Customizing Insertable Legends

The membrane keypad assembly comes with three insertable legend cards: yellow, gray and black. The following provides guidelines for creating and insertion of legend cards for the membrane switch keypad assembly. Read all of the instructions prior to customizing and inserting the legend card.

- Using the borders on the insertable legend card as a guide, be sure characters on the card are about 1.5mm (.059") within these borders. This is the printable area.
- Legend characters may be drawn, printed, etc. Be sure that application choice is completely dry before inserting into membrane keypad assembly.

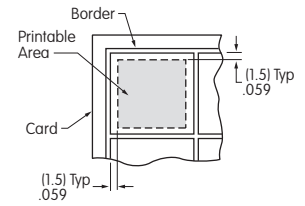

### Instructions for Inserting Legend Card

- Note correct orientation of insertable legend card. Insert card under surface sheet, and use caution to avoid bending the membrane keypad assembly. Do not use pointed object to insert card, and do not remove surface sheet.
- Align and center all legend characters within the squares of the surface sheet.
- Smooth any wrinkles or air pockets from surface sheet.
- Peel off adhesive strip from the membrane keypad assembly.
- The legend card is now firmly in place and cannot be removed.
- Detach the protective film.

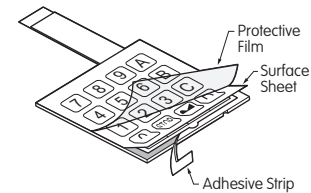
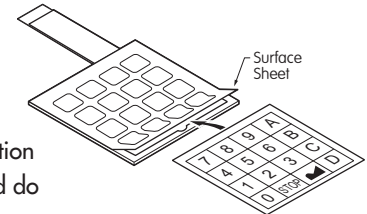

## Connectors

### Recommended Connectors for 5 Pin

Straight: FCI Part No. SLW5S-5C7LF  
Right Angle: FCI Part No. SLW5R-5C7LF

### Recommended Connectors for 8 Pin

Straight: FCI Part No. SLW8S-5C7LF  
Right Angle: FCI Part No. SLW8R-5C7LF

## PRECAUTIONS FOR HANDLING

- Assembly of legend card insert is handled by the customer. Therefore, we recommend to evaluate the finished product with the card assembled.
- Nonilluminated products have a loophole on each key. It is possible to add optional illumination by installing appropriate LEDs. Legend card does not have loopholes.
- To test proper electrical operation of switches, use of an electric buzzer is recommended.
- Use an additional chattering prevention circuit for the switch circuit.
- Do not operate switches with pointed objects (i.e. screwdrivers) to prevent perforation of film overlay.
- Use an FPC connector that corresponds to the printed circuit. Contact factory for suitable connectors.
- During assembly and installation of legends place devices on a level, sturdy surface. We do not recommend assembly and installation of device using a free hand or on a soft surface.
- Do not fold, bend, or apply pressure to the product.
- These devices contain adhesive that may emit noise. This does not affect product functionality.
- Do not depress any switch areas during assembly/installation.
- These membrane switches are built with air vents. Prior to installation, make corresponding holes to allow air vents to function. These holes should first be aligned with the membrane switch device, then made on the body of the final installation structure. Do not allow water or oil to penetrate through the air vents. Entry of any liquids through the air vents may cause contact failure.

## APPLICATIONS

- Communication equipment
- Office machines
- Electronic equipment for national security
- Automation equipment
- Electronic equipment
- Amusement equipment



# Contents Indicators

Toggles



A Series..... M3  
Complement to A Switches

Rockers



G Series..... M5  
Complement to G Switches

Pushbuttons



HB Series..... M6  
Complement to HB Pushbuttons

Illuminated PB



JF Series..... M8  
Complement to JF Tactiles

Programmable

Keylocks



KB Series..... M9  
Complement to KB Pushbuttons

Rotaries

Slides



LB Series..... M14  
Complement to LB Pushbuttons

Tactiles



P01 for MLW Series..... M19  
Complement to MLW Rockers

Tilt

Touch



UB Series..... M21  
Complement to UB Pushbuttons

Indicators



UB2 Series..... M26  
Complement to UB2 Pushbuttons

Accessories



YB Series..... M29  
Complement to YB Pushbuttons

Supplement

## TYPICAL INDICATOR ORDERING EXAMPLE

**A**

**Model**

<b>01</b>	Low .079" (2.0mm) Profile
-----------	---------------------------

**01**

**PC Terminals**

<b>P</b>	Straight
<b>B</b>	Straight with Bracket
<b>H</b>	Right Angle
<b>V</b>	Vertical

**V**

**LED Colors**

<b>C</b>	Red
<b>E</b>	Yellow
<b>F</b>	Green

**F**

DESCRIPTION FOR TYPICAL ORDERING EXAMPLE

**A01VF**

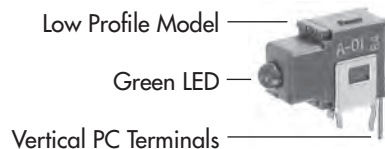

## PC TERMINALS

**P** Straight

**B** Straight with Bracket

**H** Right Angle

**V** Vertical

## LED COLORS & SPECIFICATIONS

		<b>A01</b> Indicator		
		<b>C</b>	<b>E</b>	<b>F</b>
Color		Red	Yellow	Green
LED is colored in OFF state	Color	Red	Yellow	Green
Maximum Forward Current	$I_{FM}$	50mA	50mA	50mA
Typical Forward Current	$I_F$	30mA	30mA	30mA
Forward Voltage	$V_F$	1.7V	2.2V	2.1V
Maximum Reverse Voltage	$V_{RM}$	4V	4V	4V
Current Reduction Rate Above 25°C	$\Delta I_F$	0.67mA/°C	0.67mA/°C	0.67mA/°C
Ambient Temperature Range		-30°C ~ +85°C		

Electrical specifications are determined at a basic temperature of 25°C.

If the source voltage is greater than the LED's rated voltage, a ballast resistor must be connected in series with the LED. The ballast resistor value can be calculated by using the formula shown in the Supplement section.

## TYPICAL INDICATOR DIMENSIONS

### Straight PC

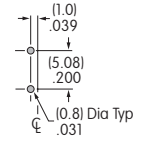
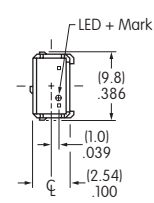
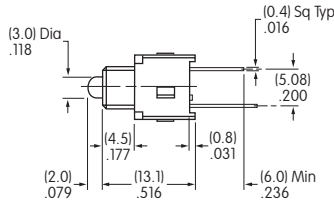
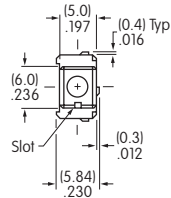

A01PF

### Straight PC • Bracket

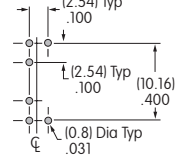
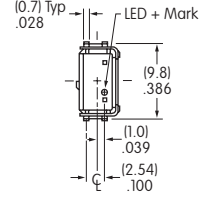
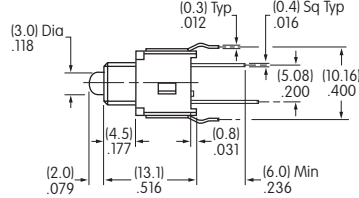
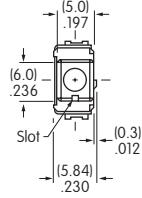

A01BF

### Right Angle PC

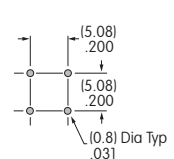
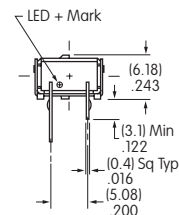
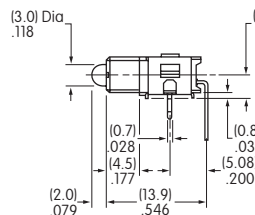
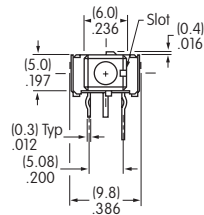

A01HF

### Vertical PC

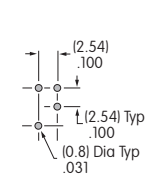
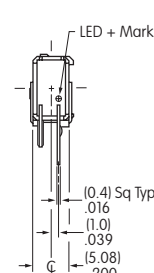
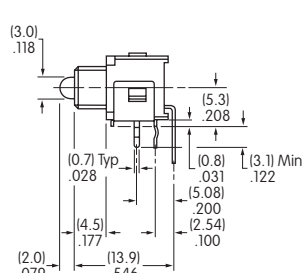
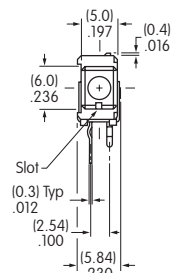

A01VF

Toggles  
Rockers  
Pushbuttons  
Illuminated PB  
Programmable  
Keylocks  
Rotaries  
Slides  
Tactiles  
Tilt  
Touch  
Indicators  
Accessories  
Supplement

TYPICAL INDICATOR ORDERING EXAMPLE

G01

P

C

DESCRIPTION FOR TYPICAL ORDERING EXAMPLE

G01PC



PC Terminals	
P	Straight
V	Vertical

LED Colors	
C	Red
E	Yellow
F	Green

Straight PC Terminals

LED COLORS & SPECIFICATIONS

		C	E	F
LED is colored in OFF state	Color	Red	Yellow	Green
Maximum Forward Current	$I_{FM}$	30mA	30mA	25mA
Typical Forward Current	$I_F$	20mA	20mA	20mA
Forward Voltage	$V_F$	2.0V	2.1V	2.25V
Maximum Reverse Voltage	$V_{RM}$	5V	5V	5V
Current Reduction Rate Above 25°C	$\Delta I_F$	0.40mA/°C	0.40mA/°C	0.33mA/°C
Ambient Temperature Range		-25°C ~ +85°C		

Electrical specifications are determined at a basic temperature of 25°C.

If the source voltage is greater than the LED's rated voltage, a ballast resistor must be connected in series with the LED. That ballast resistor value can be calculated by using the formula shown in the Supplement section.

TYPICAL INDICATOR DIMENSIONS

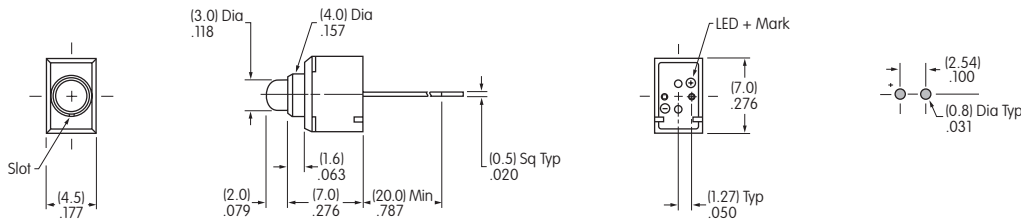

Straight PC



G01PC

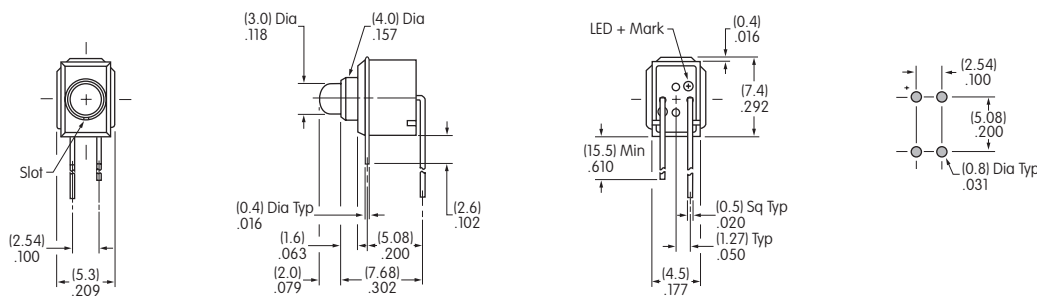

Vertical PC



G01VC

These indicators have anode and cathode terminals along with 2 support pins.

### TYPICAL INDICATOR ORDERING EXAMPLE

<b>HB</b>	<b>01</b>	<b>K</b>	<b>W01</b>	<b>5C</b>	<b>CB</b>
<b>Shapes</b>	<b>Housing</b>	<b>Terminals</b>		<b>LEDs</b>	<b>Cap Types &amp; Colors</b>
01   Square 02   Round	K   Black	W01   Silver Solder Lug		<b>Bright</b>	<b>LED Cap: Lens/Diffuser Color</b>
<b>DESCRIPTION FOR TYPICAL ORDERING EXAMPLE</b>				5C   Red	CB   Red/White
<b>HB01KW01-5C-CB</b>				5D   Amber	DB   Amber/White
				5F   Green	FB   Green/White
				<b>Super Bright</b>	
				6B   White	JB   Clear/White
				6F   Green	
				6G   Blue	

### LED COLORS & SPECIFICATIONS

The electrical specifications shown are determined at a basic temperature of 25°C. LED circuit is isolated and requires external power source. Single element LED is colored in OFF state. If the source voltage exceeds the rated voltage, a ballast resistor is required. The resistor value can be calculated by using the formula in the Supplement section.

Bright AT633		Note for Super Bright:		Bright			Super Bright			Unit	
				5C	5D	5F	6B	6F	6G		
Super Bright AT624G Blue			Color	Red	Amber	Green	White	Green	Blue		
AT629B White			Maximum Forward Current	$I_{FM}$	30	30	30	30	30	30	mA
AT630F Green			Typical Forward Current	$I_F$	20	20	20	20	20	20	mA
			Forward Voltage	$V_F$	1.95	2.0	2.1	3.3	3.3	3.3	V
			Maximum Reverse Voltage	$V_{RM}$	5	5	5	7	7	7	V
			Current Reduction Rate Above 25°C	$\Delta I_F$	0.42	0.42	0.42	0.40	0.40	0.40	mA/°C
T-1 Bi-pin		Ambient Temperature Range		-25° ~ +50°C			-25° ~ +50°C				

Toggles  
Rocker  
Pushbuttons  
Illuminated PB  
Programmable  
Keylocks  
Rotaries  
Slides  
Tactiles  
Tilt  
Touch  
Indicators  
Accessories  
Supplement



## CAP TYPES & COLORS

### Colored Cap for Bright LEDs

Lens/Diffuser  
Colors Available:

- CB** Red/White
- DB** Amber/White
- FB** Green/White

**AT4168**  
Square

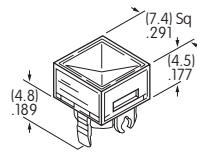

**AT4169**  
Round

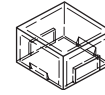
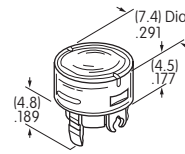

Transparent Colored Lens



Translucent White Diffuser



Colored LED AT633

Material: Polycarbonate Finish: Glossy

### White Cap for Bright & Super Bright LEDs

**JB** Clear Lens/  
White Diffuser

Material: Polycarbonate  
Finish: Glossy

**AT4033**  
Square

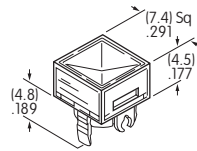

**AT4034**  
Round

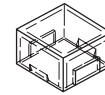
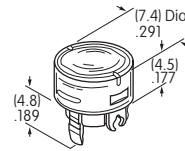

Transparent Clear Lens



Translucent White Diffuser



Colored LEDs AT624, AT629, AT630, or AT633

## TYPICAL INDICATOR DIMENSIONS

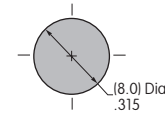
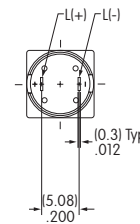
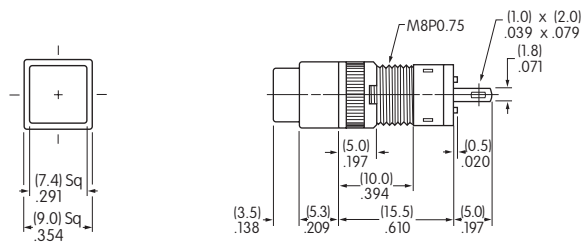

Recommended Panel Thickness: .020" ~ .197" (0.5 ~ 5.0mm)

Square



HB01KW01-5C-CB

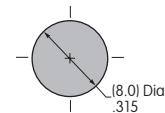
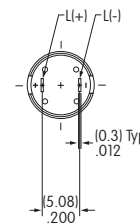
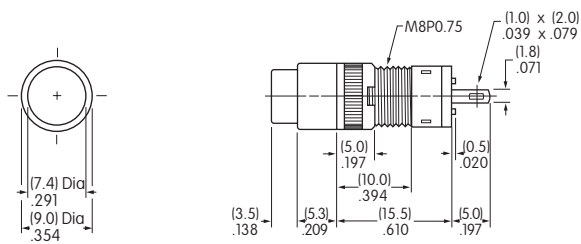

Recommended Panel Thickness: .020" ~ .197" (0.5 ~ 5.0mm)

Round



HB02KW01-5C-CB

### TYPICAL INDICATOR ORDERING EXAMPLE

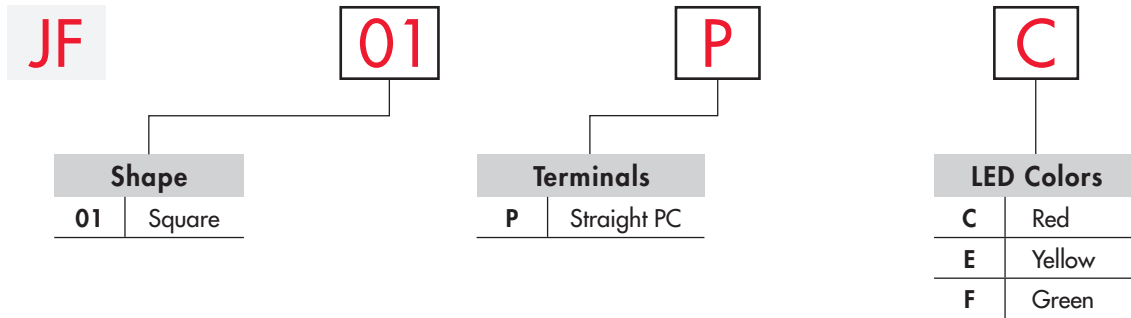

### DESCRIPTION FOR TYPICAL ORDERING EXAMPLE

**JF01PC**

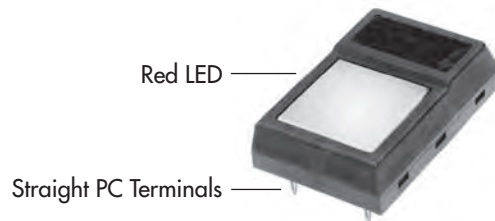

### LED COLORS & SPECIFICATIONS

LED is an integral part of the indicator and not available separately.

LED polarity markings are on the bottom of the indicator.

The electrical specifications shown are determined at a basic temperature of 25°C. If the source voltage exceeds the rated voltage, a ballast resistor is required.

The resistor value can be calculated by using the formula in the Supplement section.

		<b>C</b>	<b>E</b>	<b>F</b>
	Color	Red	Yellow	Green
Maximum Forward Current	$I_{FM}$	30mA	30mA	30mA
Typical Forward Current	$I_F$	20mA	20mA	20mA
Forward Voltage	$V_F$	1.77V	2.1V	2.3V
Maximum Reverse Voltage	$V_{RM}$	4V	4V	4V
Current Reduction Rate Above 25°C	$\Delta I_F$	0.4mA/°C	0.4mA/°C	0.4mA/°C
Ambient Temperature Range		-25° ~ +70°C		

### TYPICAL INDICATOR DIMENSIONS

#### Square



**JF01PC**

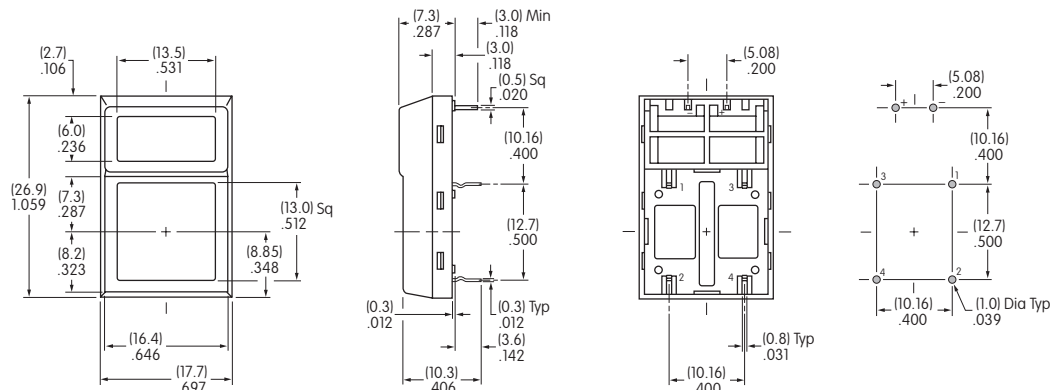

## TYPICAL INDICATOR ORDERING EXAMPLE

**KB**   **02**   **K**   **W01** — **12** — **FF**

**Shapes**

**Bushing Mounting**

01	Square
02	Round
03	Rectangular

**Snap-in Mounting**

04	Square
05	Round
06	Rectangular

**Housing**

K	Black only
---	------------

**Terminals**

W01	Silver Solder Lug
-----	-------------------

**Lamps**

**Incandescent Lamp Used with Solid Cap**

05	5-volt
12	12-volt

**Incandescent or Neon Lamp Used with Insert Cap**

05	5-volt
12	12-volt
01	110-volt Neon

**Bright LED Used with Cap for LED**

Colors	Resistor
5C Red	No Code No Resistor
5D Amber	05 5-volt
5F Green	12 12-volt
	24 24-volt

**Super Bright LED Used with Cap for LED**

6B	White
6F	Green
6G	Blue

**Cap Types & Colors**

**Solid Cap: Lens/Filter Colors**

BB	White/White	FB	Green/White
CB	Red/White	FF	Green/Green
CC	Red/Red	GB	Blue/White
EB	Yellow/White	GG	Blue/Blue

**Insert Cap: Lens/Filter Colors**

JB	Clear/White
JC	Clear/Red
JE	Clear/Yellow
*JF	Clear/Green
*JG	Clear/Blue

\* JF & JG not suitable with neon.

**LED Cap: Lens/Diffuser Colors**

AB	Square Spot Illuminated Black Cap/White Window
JB	Clear/White
JC	Clear/Red
JD	Clear/Amber
JF	Clear/Green

**LED Cap: Lens/Diffuser Colors**

JB	Clear/White
----	-------------

DESCRIPTION FOR TYPICAL ORDERING EXAMPLE

**KB02KW01-12-FF**



- 12-volt Incandescent Lamp Solid Cap with Green Lens and Green Filter
- Black Housing Round with Bushing Mounting
- Silver Solder Lug Terminals

### SHAPES & MOUNTING TYPES

#### Bushing Mounting

**01** .551" (14mm)  
Square

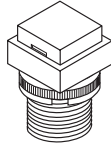

**02** .551" (14mm)  
Round

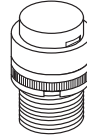

**03** .551" x .728" (14mm x 18.5mm)  
Rectangular

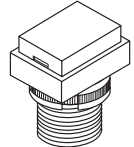

#### Snap-in Mounting

**04** .551" (14mm)  
Square

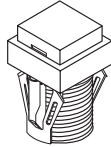

**05** .551" (14mm)  
Round

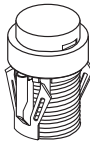

**06** .551" x .728" (14mm x 18.5mm)  
Rectangular

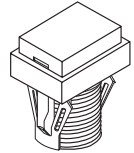

The bezel is an integral part of the indicator body.

#### Bushing Mounting

Without  
Keyway

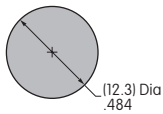

Panel Thickness:  
.020" ~ .315"  
(0.5 ~ 8mm)

#### Panel Cutouts

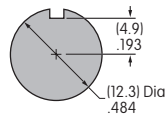

With  
Keyway

#### Snap-in Mounting

Panel Thickness:  
.039" ~ .138"  
(1.0 ~ 3.5mm)

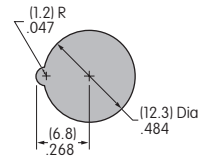

### TERMINALS

**W01**

Silver Solder Lug

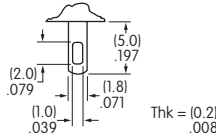

### LAMP COLORS & SPECIFICATIONS

The electrical specifications shown are determined at a basic temperature of 25°C.  
If the source voltage exceeds the rated voltage, a ballast resistor is required.  
The ballast resistor calculation and more lamp detail are shown in the Supplement section.

#### Incandescent & Neon Lamps

AT611 Incandescent	AT615 Neon		<b>05</b>	<b>12</b>	<b>01</b>	Recommended Resistors for Neon: 33K ohms for 110V AC; 100K ohms for 220V AC
			Voltage	V	5V AC	
Current	I	115mA	60mA	1.5mA		
Endurance	Hours	7,000 average		10,000		

#### Bright LED without Resistor

AT635	Color Codes	Red	Amber	Green	<b>No Code</b> No Resistor	
		<b>5C</b>	<b>5D</b>	<b>5F</b>		
LEDs are colored in OFF state.	Maximum Forward Current	$I_{FM}$			30mA	
	Typical Forward Current	$I_F$			20mA	
	Forward Voltage	$V_F$			1.9V	
	Maximum Reverse Voltage	$V_{RM}$			5V	
	Current Reduction Rate Above 25°C	$\Delta I_F$			0.42mA/°C	
	Ambient Temperature Range	-25° ~ +50°C				



T-1 1/2 Bi-pin

**LAMP COLORS & SPECIFICATIONS**

The electrical specifications shown are determined at a basic temperature of 25°C.  
 If the source voltage exceeds the rated voltage, a ballast resistor is required.  
 The ballast resistor calculation and more lamp detail are shown in the Supplement section.

**Bright LED with Resistor**

<b>AT634</b>  LEDs are colored in OFF state.    T-1 1/4 Bi-pin	Color Codes: <table border="1" style="display: inline-table; margin: 0 10px;"> <tr><td>Red</td></tr> <tr><td><b>5C</b></td></tr> </table> <table border="1" style="display: inline-table; margin: 0 10px;"> <tr><td>Amber</td></tr> <tr><td><b>5D</b></td></tr> </table> <table border="1" style="display: inline-table; margin: 0 10px;"> <tr><td>Green</td></tr> <tr><td><b>5F</b></td></tr> </table>	Red	<b>5C</b>	Amber	<b>5D</b>	Green	<b>5F</b>	<b>Resistor Codes</b> <table border="1" style="display: inline-table; margin: 0 10px;"> <tr><td><b>05</b></td></tr> </table> <table border="1" style="display: inline-table; margin: 0 10px;"> <tr><td><b>12</b></td></tr> </table> <table border="1" style="display: inline-table; margin: 0 10px;"> <tr><td><b>24</b></td></tr> </table>			<b>05</b>	<b>12</b>	<b>24</b>
	Red												
	<b>5C</b>												
	Amber												
	<b>5D</b>												
	Green												
	<b>5F</b>												
	<b>05</b>												
<b>12</b>													
<b>24</b>													
Maximum Forward Current	$I_{FM}$	—	—	—									
Typical Forward Current	$I_F$	25mA	20mA	10mA									
Forward Voltage	$V_F$	5V	12V	24V									
Maximum Reverse Voltage	$V_{RM}$	4V	8V	16V									
Current Reduction Rate Above 25°C	$\Delta I_F$	—	—	—									
Ambient Temperature Range		-25° ~ +50°C											

AT634  
5-volt  
2-element  
with 1 Resistor

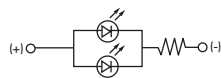

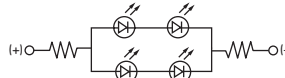

AT634  
12-volt  
4-element  
with 2 Resistors

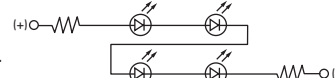

AT634  
24-volt  
4-element  
with 2 Resistors



**Super Bright Single Element LED**

<b>AT625G Blue</b>  <b>AT631B White</b>  <b>AT632F Green</b>    T-1 Bi-pin				<table border="1" style="display: inline-table; margin: 0 10px;"> <tr><td><b>6B</b></td></tr> </table>	<b>6B</b>	<table border="1" style="display: inline-table; margin: 0 10px;"> <tr><td><b>6F</b></td></tr> </table>	<b>6F</b>	<table border="1" style="display: inline-table; margin: 0 10px;"> <tr><td><b>6G</b></td></tr> </table>	<b>6G</b>
	<b>6B</b>								
	<b>6F</b>								
	<b>6G</b>								
	Color	White	Green	Blue					
	Maximum Forward Current	$I_{FM}$	30mA	30mA	30mA				
	Typical Forward Current	$I_F$	20mA	20mA	20mA				
	Forward Voltage	$V_F$	3.3V	3.3V	3.3V				
Maximum Reverse Voltage	$V_{RM}$	7V	7V	7V					
Current Reduction Rate Above 25°C	$\Delta I_F$	0.40mA/°C	0.40mA/°C	0.40mA/°C					
Ambient Temperature Range		-25° ~ +50°C							

**CAP TYPES & COLOR COMBINATIONS**

Color Codes:    **B** White    **C** Red    **E** Yellow    **F** Green    **G** Blue    **J** Clear

**Solid Cap for Incandescent Lamp**

Lens/Filter Colors Available:

- |           |           |
|-----------|-----------|
| <b>BB</b> | <b>FB</b> |
| <b>CB</b> | <b>FF</b> |
| <b>CC</b> | <b>GB</b> |
| <b>EB</b> | <b>GG</b> |

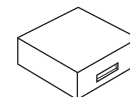
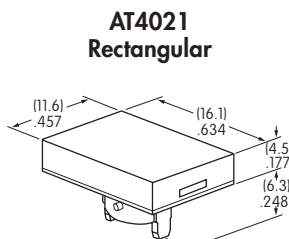
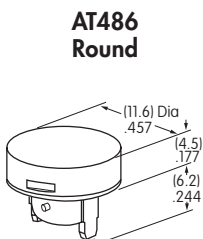
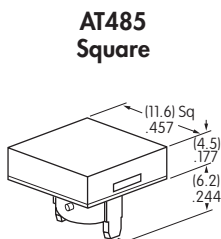

Translucent Colored Lens



Translucent Colored Filter



Lamp AT611

Material: Polycarbonate    Finish: Glossy

Toggles  
 Rockers  
 Pushbuttons  
 Illuminated PB  
 Programmable  
 Key locks  
 Rotaries  
 Slides  
 Tactiles  
 Tilt  
 Touch  
 Accessories  
 Supplement

### CAP TYPES & COLOR COMBINATIONS

Color Codes: A Black B White C Red D Amber E Yellow F Green G Blue J Clear

#### Insert Cap for Incandescent or Neon Lamp

Lens/Filter Colors Available:

**JB**

**AT487**  
Square

**AT488**  
Round

**AT4022**  
Rectangular



Transparent Clear Lens

**JC**

**JE**

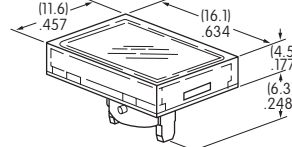
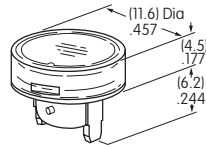
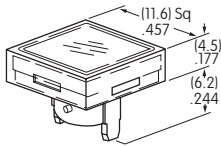

Translucent Colored Filter

**JF**

**JG**



JF and JG not suitable with neon lamp.

Material: Polycarbonate Finish: Glossy

Lamp AT611 Lamp AT615

#### Spot Illuminated Cap for Bright LED without Resistor or with Resistor

Cap/Window Colors Available:

**AB**

Opaque Black Cap with Translucent White Window for Spot Illumination

**AT4051**  
Square

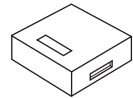
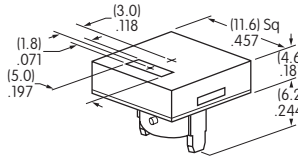

Bright LED AT635

Bright LED AT634

Material: Polycarbonate Finish: Matte

#### Cap for Bright LED without Resistor or LED with Resistor

Lens/Diffuser Colors Available: (AT4133, 4132, 4134 white diffusers; AT4158, 4160, 4159 colored diffusers)

**JB**

**AT4133**

**AT4132**

**AT4134**



Transparent Clear Lens

Square

Round

Rectangular

**JC**

**AT4158**

**AT4160**

**AT4159**



Translucent Diffuser

**JD**

**JF**

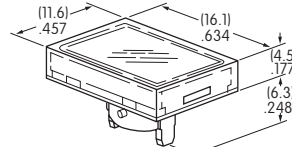
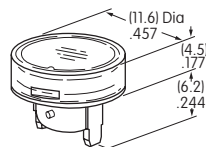
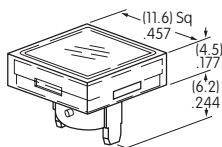

Bright LED AT635

Bright LED AT634

Material: Polycarbonate Finish: Glossy

## CAP TYPES & COLOR COMBINATIONS

Cap for Super Bright LED

Lens/Diffuser  
Colors Available:

**JB**

Clear Lens  
White Diffuser

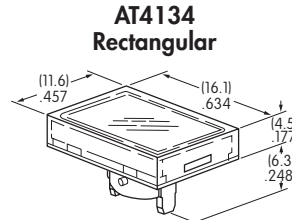
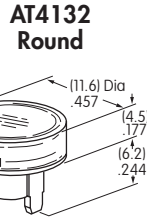
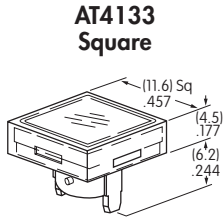

Translucent Clear Lens



Translucent White Diffuser



Super Bright LEDs  
AT625, AT631, AT632

Material: Polycarbonate Finish: Glossy

## TYPICAL INDICATOR DIMENSIONS

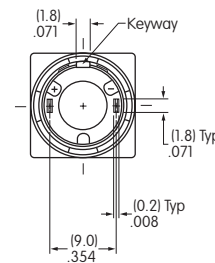
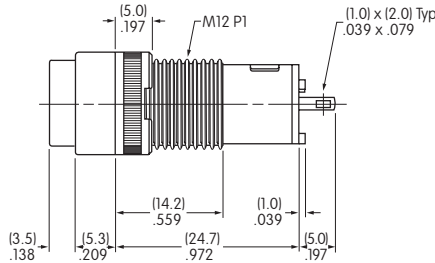
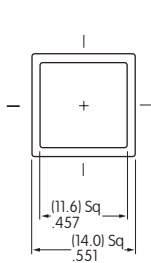
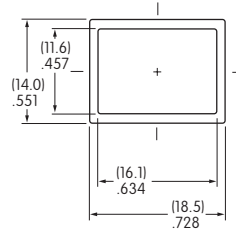
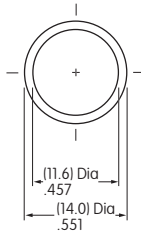

Bushing Mount



KB01KW01-05-GG

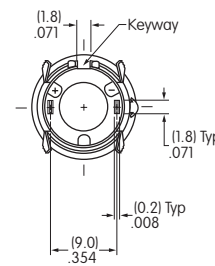
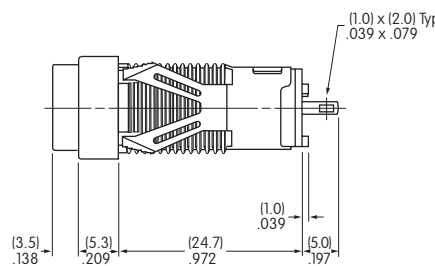
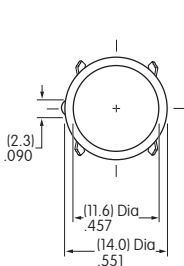
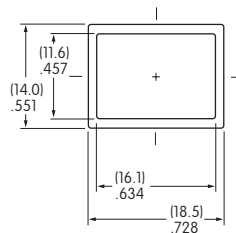
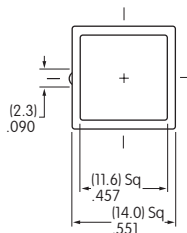

Snap-in Mount



KB05KW01-05-FF

### TYPICAL INDICATOR ORDERING EXAMPLE

**LB 01 G W01 — 5C12 — JC**

Shapes	
01	Square
02	Round
03	Rectangular

Housing	
K	Black
G	Gray

Terminals	
W01	Silver Solder Lug/ Quick Connect Terminals

Lamps			
Incandescent Lamp Used with Solid Cap			
05	5-volt		
12	12-volt		
Incandescent or Neon Used with Insert Cap			
01	110-volt Neon		
05	5-volt Incandescent		
12	12-volt Incandescent		

Bright LED Used with LED Cap			
Colors		Resistor	
5C	Red	No Code	No Resistor
5D	Amber	05	5-volt
		12	12-volt
5F	Green	24	24-volt

Super Bright LED Used with LED Cap	
6B	White
6F	Green
6G	Blue

Cap Types & Colors	
Solid Cap: Lens/Filter Colors	
BJ	White/Clear
CJ	Red/Clear
EJ	Yellow/Clear
FJ	Green/Clear
GJ	Blue/Clear
Insert Cap: Lens/Filter Colors	
JB	Clear/White
JC	Clear/Red
JE	Clear/Yellow
*JF	Clear/Green
*JG	Clear/Blue
*JF & JG not suitable with neon.	
LED Cap: Lens/Diffuser Colors	
JB	Clear/White
JC	Clear/Red
JD	Clear/Amber
JF	Clear/Green
LED Cap: Lens/Diffuser Colors	
JB	Clear/White

### DESCRIPTION FOR TYPICAL ORDERING EXAMPLE

#### LB01GW01-5C12-JC

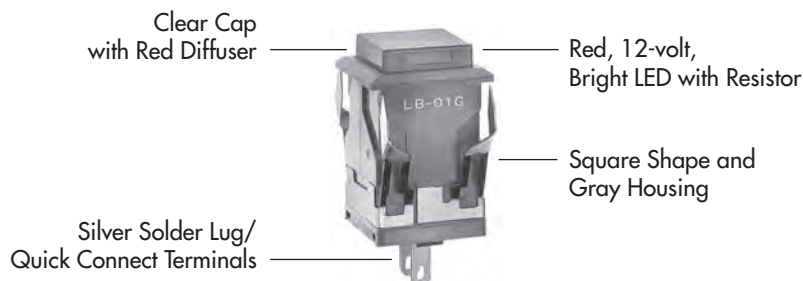

Toggles  
 Rockers  
 Pushbuttons  
 Illuminated PB  
 Programmable  
 Keylocks  
 Rotaries  
 Slides  
 Tactiles  
 Tilt  
 Touch  
 Accessories  
 Supplement

Indicators **M**



**SHAPES & PANEL CUTOUTS**

**01** .622" (15.8mm)  
Square

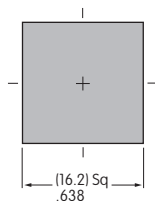
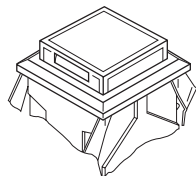

**02** .854" (21.7mm)  
Round

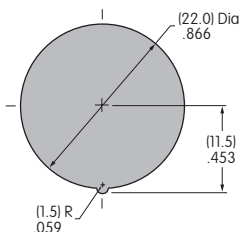
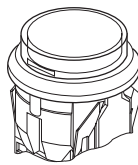

**03** .622" x .866" (15.8mm x 22.0mm)  
Rectangular

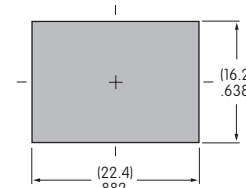
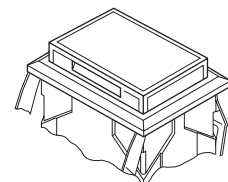

Panel Thickness: .039" ~ .157" (1.0 ~ 4.0mm)

**HOUSING**

Housing Colors Available:

**K** Black

**G** Gray

**TERMINALS**

**W01** Silver Solder Lug/.110" (2.8mm) Quick Connect

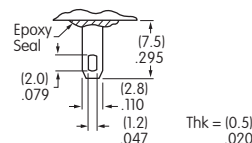

**LAMP CODES & SPECIFICATIONS**

**Incandescent Lamp for Solid Colored and Colored Insert Caps**

<b>AT607</b>   T-1 Bi-pin		<b>05</b>	<b>12</b>	
	Voltage	V	5V AC	12V AC
	Current	I	115mA	60mA
	Endurance	Hours	10,000 average	
	Ambient Temp. Range		-25°C ~ +50°C	

**Neon Lamp for Colored Insert Cap**

<b>AT607N</b>   T-1 Bi-pin		<b>01</b>	
	Voltage	V	110V AC
	Current	I	1.5mA
	Endurance	Hours	10,000 average
	Ambient Temp. Range		-25°C ~ +50°C
Recommended Resistors: 33K ohms for 110V AC; 100K ohms for 220V AC			

The electrical specifications shown are determined at a basic temperature of 25°C.

Toggle  
Rockers  
Pushbuttons  
Illuminated PB  
Programmable  
Key locks  
Rotaries  
Slides  
Tactiles  
Tilt  
Touch  
Accessories  
Supplement



### LED COLORS & SPECIFICATIONS

The electrical specifications shown are determined at a basic temperature of 25°C. Polarity marks are on the device.  
 If the source voltage exceeds the rated voltage, a ballast resistor is required.  
 The resistor value can be calculated by using the formula in the Supplement section.  
 Additional lamp detail is shown in the Accessories & Hardware section.

#### Bright LED without Resistor

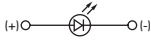
<b>AT635</b>  LEDs are colored in OFF state.      T-1 1/2 Bi-pin	Red      Amber      Green Color Codes <b>5C</b> <b>5D</b> <b>5F</b> <b>No Code</b> No Resistor
	Maximum Forward Current $I_{FM}$ 30mA      30mA      30mA
	Typical Forward Current $I_F$ 20mA      20mA      20mA
	Forward Voltage $V_F$ 1.9V      2.0V      2.1V
	Maximum Reverse Voltage $V_{RM}$ 5V      5V      5V
	Current Reduction Rate Above 25°C $\Delta I_F$ 0.42mA/°C      0.42mA/°C      0.42mA/°C
	Ambient Temperature Range      -25° ~ +50°C

#### Bright LED with Resistor

<b>AT627 with Resistor</b>    T-1 Bi-pin	Red      Amber      Green Color Codes: <b>5C</b> <b>5D</b> <b>5F</b> Resistor Codes <b>05</b> <b>12</b> <b>24</b>
	Maximum Forward Current $I_{FM}$ —      —      —
	Typical Forward Current $I_F$ 52mA      26mA      13mA
	Forward Voltage $V_F$ 5V      12V      24V
	Maximum Reverse Voltage $V_{RM}$ 4V      8V      16V
	Current Reduction Rate Above 25°C $\Delta I_F$ 0.50mA/°C
	Ambient Temperature Range      -25° ~ +50°C

AT627  
5-volt  
4-element  
with Resistor

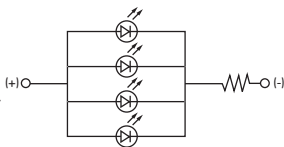

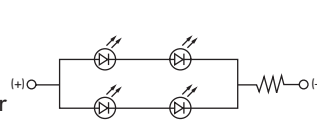

AT627  
12-volt  
4-element  
with Resistor

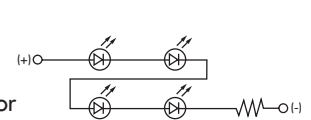

AT627  
24-volt  
4-element  
with Resistor



#### Super Bright Single Element LED

<b>AT625G Blue</b> <b>AT631B White</b> <b>AT632F Green</b>      T-1 Bi-pin		Color <b>6B</b> <b>6F</b> <b>6G</b> White      Green      Blue
	Maximum Forward Current $I_{FM}$ 30mA      30mA      30mA	
	Typical Forward Current $I_F$ 20mA      20mA      20mA	
	Forward Voltage $V_F$ 3.3V      3.3V      3.3V	
	Maximum Reverse Voltage $V_{RM}$ 7V      7V      7V	
	Current Reduction Rate Above 25°C $\Delta I_F$ 0.40mA/°C      0.40mA/°C      0.40mA/°C	
	Ambient Temperature Range      -25° ~ +50°C	

**CAP TYPES & COLOR COMBINATIONS**

Color Codes: B White C Red D Amber E Yellow F Green G Blue J Clear

**Solid Cap for Incandescent Lamp**

Lens/Filter Colors Available:

- BJ** **FJ**
- CJ** **GJ**
- EJ**

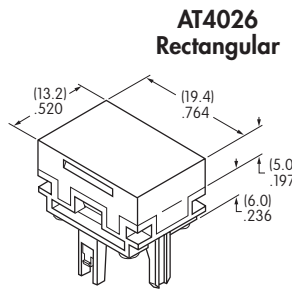
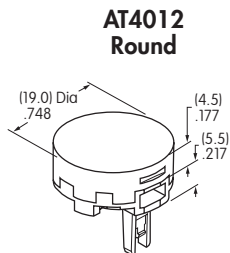
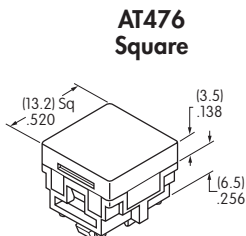

Translucent Colored Lens



Transparent Clear Filter



Lamp AT607

Material: Polycarbonate Finish: Glossy

**Insert Cap for Incandescent or Neon Lamp**

Lens/Filter Colors Available:

- JB** **JF**
- JC** **JG**
- JE**

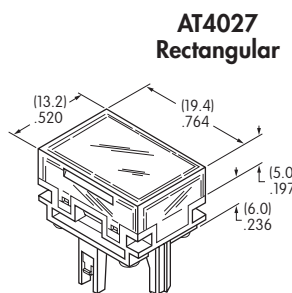
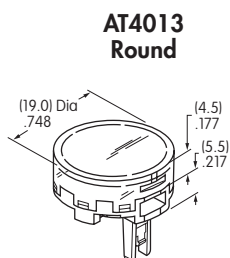
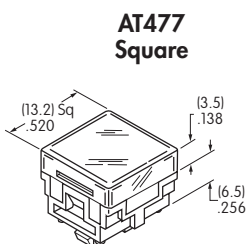

Transparent Clear Lens



Translucent Colored Filter



Lamp AT607 or 607N

Material: Polycarbonate Finish: Glossy

JF and JG not suitable with neon lamp.

**Cap for Bright LED without Resistor**

Lens/Diffuser Colors Available:

- JB**
- JC**
- JD**
- JF**

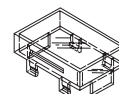
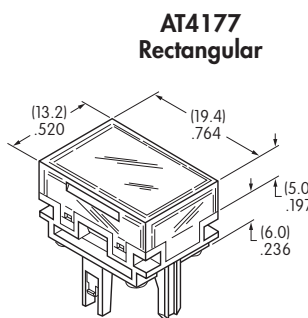
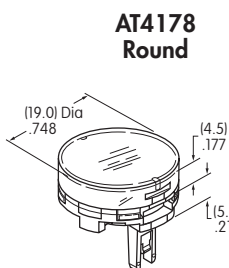
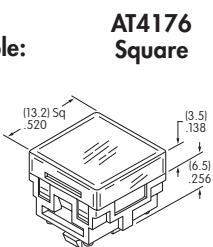

Transparent Clear Lens

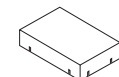

Translucent Colored Diffuser



Bright LED AT635

Material: Polycarbonate Finish: Glossy

**Cap for Bright LED with Resistor**

Lens/Diffuser Colors Available:

- JB**
- JC**
- JD**
- JF**

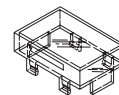
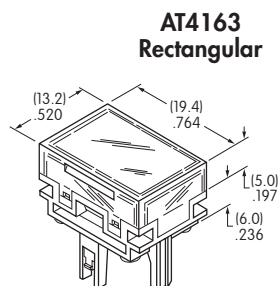
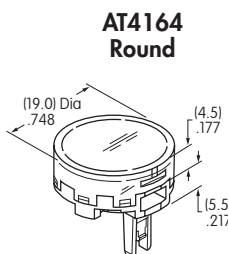
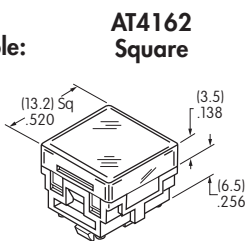

Transparent Clear Lens

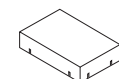

Translucent Colored Diffuser



Bright LED AT627

Material: Polycarbonate Finish: Glossy

Toggles  
 Rockers  
 Pushbuttons  
 Illuminated PB  
 Programmable  
 Keylocks  
 Rotaries  
 Slides  
 Tactiles  
 Tilt  
 Touch  
 Indicators  
 Accessories  
 Supplement

## CAP TYPES & COLOR COMBINATIONS

### Cap for Super Bright LEDs



**Clear Lens  
White Diffuser**

**AT4129  
Square**

**AT4128  
Round**

**AT4130  
Rectangular**

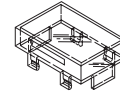

Transparent  
Clear Lens

Material:  
Polycarbonate  
Finish: Glossy

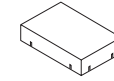
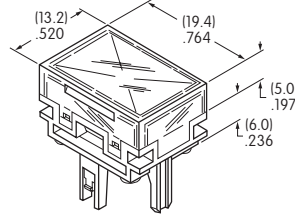
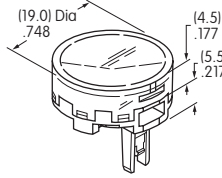
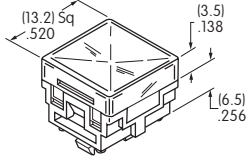

Translucent  
White Diffuser



LEDs AT625  
AT631 AT632

## TYPICAL INDICATOR DIMENSIONS

### Square

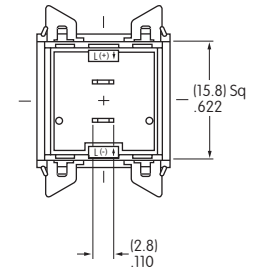
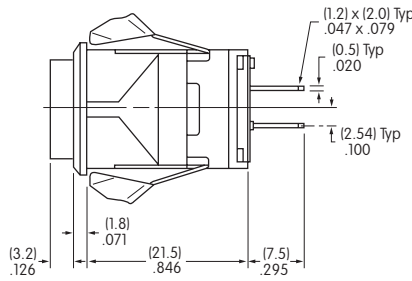
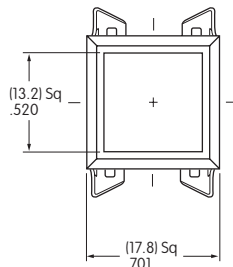

**LB01KW01-12-CJ**

### Round

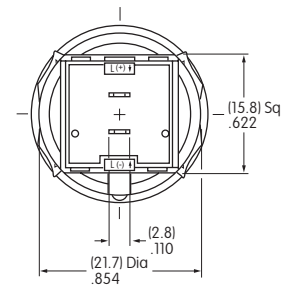
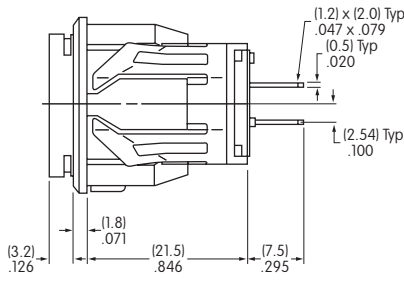
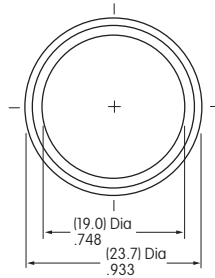

**LB02KW01-12-CJ**

### Rectangular

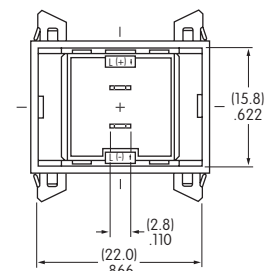
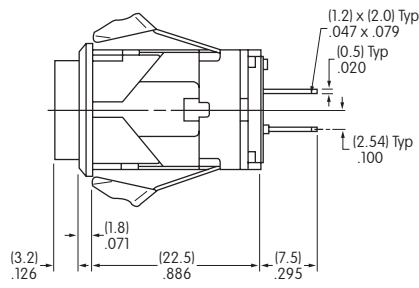
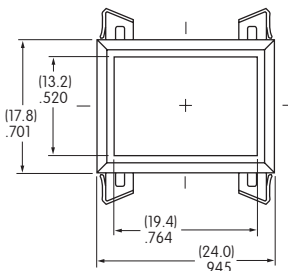

**LB03KW01-12-CJ**

Toggles  
 Rockers  
 Pushbuttons  
 Illuminated PB  
 Programmable  
 Keylocks  
 Rotaries  
 Slides  
 Tactiles  
 Tilt  
 Touch  
 Indicators  
 Accessories  
 Supplement

## TYPICAL INDICATOR ORDERING EXAMPLE

**P01**

**12**

**C**

**1**

**A**

Lamps	
Incandescent	
06	6-volt
12	12-volt
18	18-volt
24	24-volt
28	28-volt
Neon	
N	110-volt

Cap Colors	
B	White
C	Red
D	Orange
E	Yellow
*F	Green
*G	Blue

\*F & G not suitable with neon.

Bezels	
1	.787" (20.0mm) Wide
2	.937" (23.8mm) Wide

Bezel Colors	
A	Black
B	White
C	Red
D	Orange
E	Yellow
F	Green
G	Blue
H	Gray

### DESCRIPTION FOR TYPICAL ORDERING EXAMPLE

**P01-12-C-1A**



## LAMP CODES & SPECIFICATIONS

### Incandescent & Neon Lamps for Solid & Design Caps

AT602 Incandescent	AT602N Neon		<b>06</b>	<b>12</b>	<b>18</b>	<b>24</b>	<b>28</b>	<b>N</b>	
		Voltage	6V	12V	18V	24V	28V	110V	
		Current	80mA	50mA	35mA	25mA	22mA	1.5mA	
		MSCP	.159	.215	.398	.215	.247	NA	
		Endurance	2,000 Average					15,000 Avg.	
		Ambient Temperature Range	-10° ~ +50°C						
T- 1 1/2 Pilot Slide Base		Recommended Resistor for Neon: 33K ohms for 110V AC & 100K ohms for 220V AC							

Electrical specifications are determined at a basic temperature of 25°C.

For dimension drawings of lamps, see Accessories & Hardware Index.

If the source voltage is greater than rated voltage, a ballast resistor is required.

The ballast resistor calculation and more lamp detail are shown in the Supplement section.

## CAP COLORS

<b>B</b> White	<b>D</b> Orange	<b>F</b> Green
<b>C</b> Red	<b>E</b> Yellow	<b>G</b> Blue

Material: Polycarbonate

Finish: Glossy

F & G not suitable for neon

**AT429**

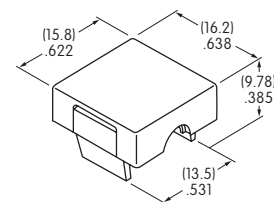

### OPTIONAL BEZELS & COLORS

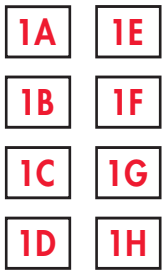

**AT204**  
**.787" (20.0mm) Wide Bezel**

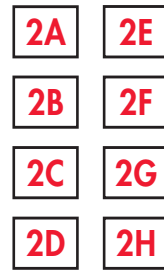
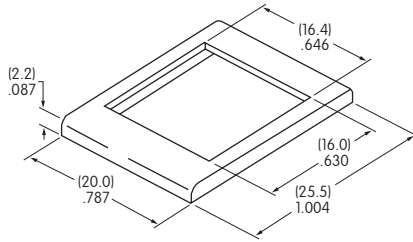

**AT9201**  
**.937" (23.8mm) Wide Bezel**

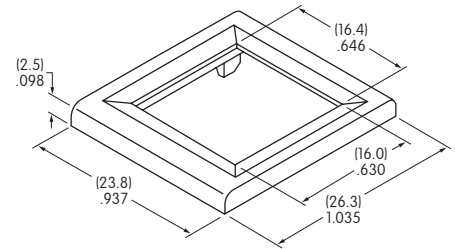

Material: Polycarbonate      Standard Finish: Glossy

**Color Codes:**    A Black    B White    C Red    D Orange    E Yellow    F Green    G Blue    H Gray

### TYPICAL INDICATOR DIMENSIONS

#### Without Bezel

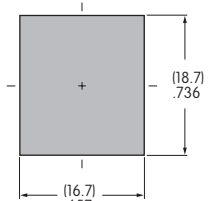
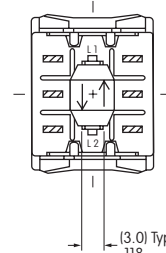
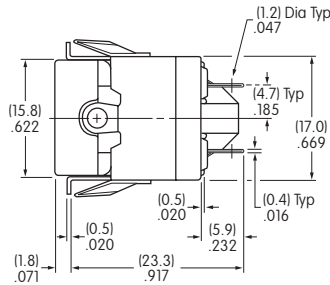
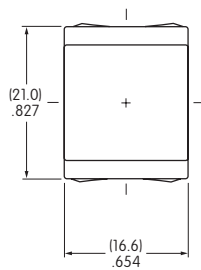

Panel Thickness:  
 .039" ~ .157"  
 (1.0mm ~ 4.0mm)

**P01-12-C**

#### With Bezel

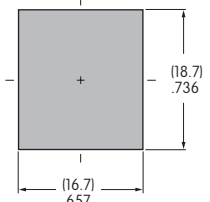
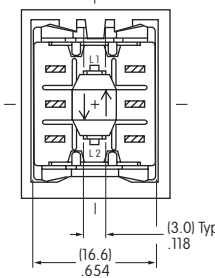
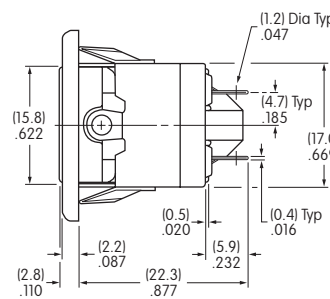
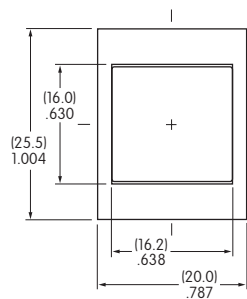

Panel Thickness:  
 .039" ~ .157"  
 (1.0mm ~ 4.0mm)

**P01-12-C-1A**

#### With Large Bezel

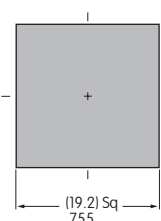
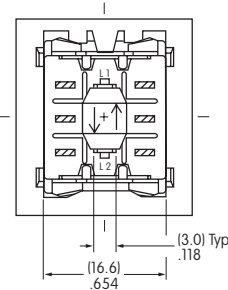
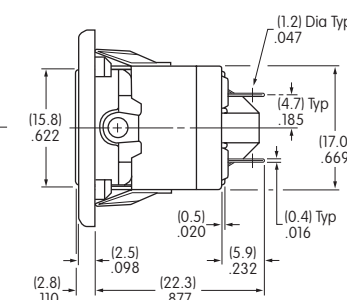
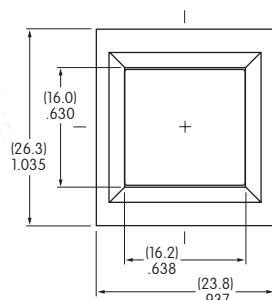

Panel Thickness:  
 .039" ~ .157"  
 (1.0mm ~ 4.0mm)

**P01-12-C-2A**



**Mounting Types**

**PCB Mounting**

01	Square
03	Rectangular

**\* Snap-in Mounting**

04	Square
06	Rectangular
06B	Rectangular with Side Barriers

\* Standard with Solder Lug terminals

**Housing**

K	Black
---	-------

**Terminals**

W01	Silver Solder Lug (for Snap-in Mounting)
W03	Silver Straight PC (for PCB Mounting)

**LEDs**

**Bright LED**

5C	Red
5D	Amber
5F	Green

**Super Bright LED**

6B	White
6F	Green
6G	Blue

**Super Bright Bicolor LED**

6CF	Red/Green
6DG	Amber/Blue

**Cap Types & Colors**

**Full Face Illuminated Cap for Bright LED**

Lens/Diffuser Colors

CB	Red/White	FF	Green/Green
CC	Red/Red	*FJ	Green/Clear
*CJ	Red/Clear	JB	Clear/White
DB	Amber/White	JC	Clear/Red
DD	Amber/Amber	JD	Clear/Amber
*DJ	Amber/Clear	JF	Clear/Green
FB	Green/White	*JJ	Clear/Clear

\* Not available with Rectangular cap

**Full Face Illuminated Cap for Super Bright LED**

JB	Clear Lens/White Diffuser
----	---------------------------

**Spot Illuminated Cap for Bright & Super Bright LEDs**

AB	Black with White Window
----	-------------------------

**Bicolor Alternating Legend Cap/Diffuser for Square or Rectangular**

JCF	Red/Green
JDG	Amber/Blue

DESCRIPTION FOR TYPICAL ORDERING EXAMPLE

UB01KW035C-JC



**Alternating Legends**

11	ON (pos)	OFF (pos)
12	ON (neg)	OFF (neg)
13	START	STOP
14	OPEN	CLOSE

**Part Numbers for Alternating Legends**

Square Alternating Legends				Rectangular Alternating Legends			
Color	Part Number	Color	Part Number	Color	Part Number	Color	Part Number
Red/Green	AT9450CF11	Amber/Blue	AT9450DG11	Red/Green	AT9451CF11	Amber/Blue	AT9451DG11
	AT9450CF12		AT9450DG12		AT9451CF12		AT9451DG12
	AT9450CF13		AT9450DG13		AT9451CF13		AT9451DG13
	AT9450CF14		AT9450DG14		AT9451CF14		AT9451DG14

Refer to Ordering Table for Alternating Legend that corresponds with last 2 digits of part number.

## BRIGHT & SUPER BRIGHT LED COLORS & SPECIFICATIONS

The electrical specifications shown are determined at a basic temperature of 25°C. LED circuit is isolated and requires external power source. Polarity marks are on bottom of switch. If the source voltage exceeds the rated voltage, a ballast resistor is required. Resistor value can be calculated by using the formula in the Supplement section. LED is an integral part of switch and not available separately.

	Super Bright LEDs are Electrostatic Sensitive	Bright			Super Bright			Unit	
		5C	5D	5F	6B	6F	6G		
		Color	Red	Amber	Green	White	Green	Blue	
Maximum Forward Current		$I_{FM}$	30	30	25	30	30	30	mA
Typical Forward Current		$I_F$	20	20	20	20	20	20	mA
Forward Voltage		$V_F$	1.85	2.0	2.1	3.2	3.2	3.2	V
Maximum Reverse Voltage		$V_{RM}$	5	5	5	5	5	5	V
Current Reduction Rate Above 25°C		$\Delta I_F$	0.40	0.42	0.46	0.40	0.40	.040	mA/°C
Ambient Temperature Range			-25° ~ +50°C			-25° ~ +50°C			

## CAP TYPES & COLOR COMBINATIONS

### Full Face Illuminated Cap for Bright LED

#### Lens/Diffuser

Colors Available for Square Cap:

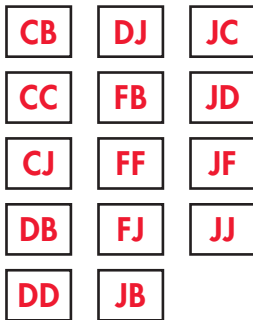

AT4074  
Lens

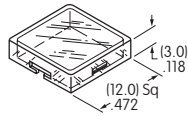

AT4075  
Diffuser



#### Lens/Diffuser

Colors Available for Rectangular Cap:

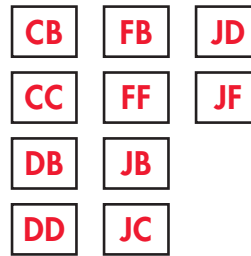

AT4117  
Lens

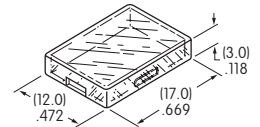

AT4118  
Diffuser

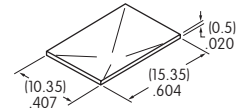

Lens & Diffuser Material: Polycarbonate    Lens Finish: Glossy    Diffuser Finish: Textured

### Full Face Illuminated Caps for Super Bright Bicolor LED



AT4074 Square Lens

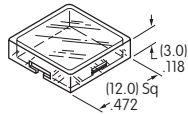

AT4117 Rectangular Lens

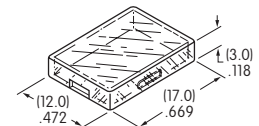

AT4188 Square Diffuser



AT4189 Rectangular Diffuser

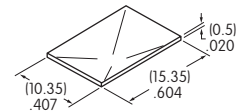

Lens & Diffuser Material: Polycarbonate    Lens Finish: Glossy    Diffuser Finish: Textured

### Spot Illuminated Caps

**AB** Black Cap with Translucent White Window for LED Display

Material: Polycarbonate  
Finish: Matte

AT4119 Square for Bright and Super Bright LED

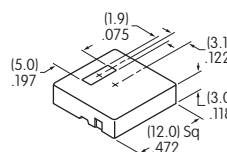

AT4120 Rectangular for Bright and Super Bright LED

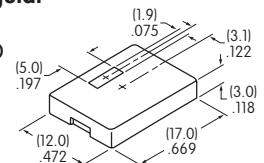

Color Codes:    A Black    B White    C Red    D Amber    F Green    J Clear

Toggles  
Rockers  
Pushbuttons  
Illuminated PB  
Programmable  
Keylocks  
Rotaries  
Slides  
Tactiles  
Tilt  
Touch  
Indicators  
Accessories  
Supplement



**SUPER BRIGHT BICOLOR LEDs FOR ALTERNATING LEGENDS**

The electrical specifications shown are determined at a basic temperature of 25°C. LED circuit is isolated and requires external power source. Polarity marks are on bottom of switch. If the source voltage exceeds the rated voltage, a ballast resistor is required. Resistor value can be calculated by using the formula in the Supplement section. LED is an integral part of switch and not available separately.

**Electrical Specifications for Super Bright Bicolor LEDs**

Super Bright LEDs are Electrostatic Sensitive	ATTENTION ELECTROSTATIC SENSITIVE DEVICES	6CF		6DG		Unit
		Red	Green	Amber	Blue	
Maximum Forward Current	$I_{FM}$	* 30	* 30	* 30	* 30	mA
Typical Forward Current	$I_F$	20	20	20	20	mA
Forward Voltage	$V_F$	2.3	3.2	2.1	3.0	V
Maximum Reverse Voltage	$V_{RM}$	4	4	4	4	V
Current Reduction Rate Above 25°C	$\Delta I_F$	0.33	0.33	0.33	0.33	mA/°C
Ambient Temperature Range		-25° ~ +50°		-25° ~ +50°		°C

\* Value applies to single color illumination for either Red or Green or Amber or Blue. When both colors are illuminated simultaneously, the sum of the currents should not exceed the smallest value of the maximum forward current.

Super Bright Bicolor Red/Green LED with 2 elements

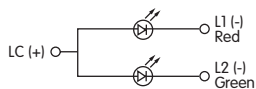

Super Bright Bicolor Amber/Blue LED with 2 elements

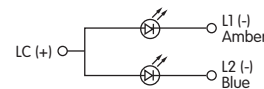

**Alternating Legend Caps for Super Bright Bicolor LED**

JCF JDG

AT4074 12.0mm Square Flat Cap

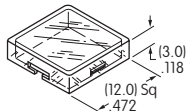

AT9450 Square Legend Insert



AT4188 Square Diffuser



JCF JDG

AT4117 12.0mm x 17.0mm Rectangular Flat Cap

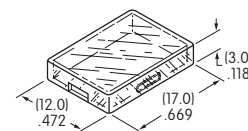

AT9451 Rectangular Legend Insert



AT4189 Rectangular Diffuser



Lens & Diffuser Material: Polycarbonate Legend Insert Material: Polyethylene Terephthalate (PET)  
 Lens Finish: Glossy Diffuser Finish: Textured

**Standard Alternating Legend Pairs**

11



Green/Red or Blue/Amber

12



Green/Red or Blue/Amber

13



Green/Red or Blue/Amber

14



Green/Red or Blue/Amber

Cap illumination is alternating Green/Red or Blue/Amber; legend text is black.  
 Contact factory for other Alternating Legends.

Legend illustrations are approximate representations of the actual characters on the filters.

## TYPICAL INDICATOR DIMENSIONS

### Square • PCB Mount

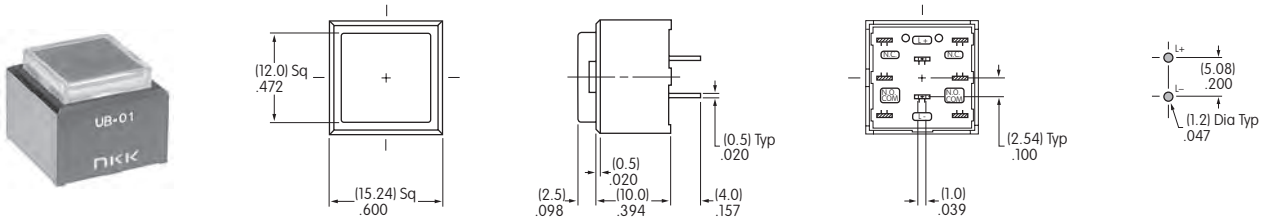

UB01KW035C-JC

### Rectangular • PCB Mount

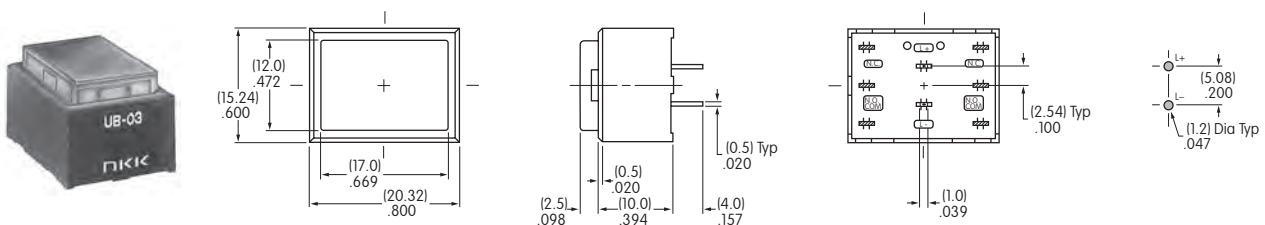

UB03KW035F-FF

### Square • Snap-in Mount • Built-in Bezel

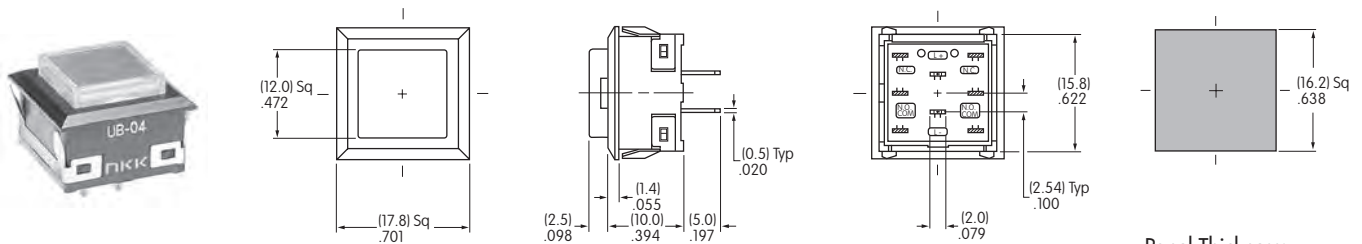

UB04KW015C-JC

Panel Thickness:  
1.0 ~ 3.2mm (.039 ~ .126")

### Rectangular • Snap-in Mount • Built-in Bezel

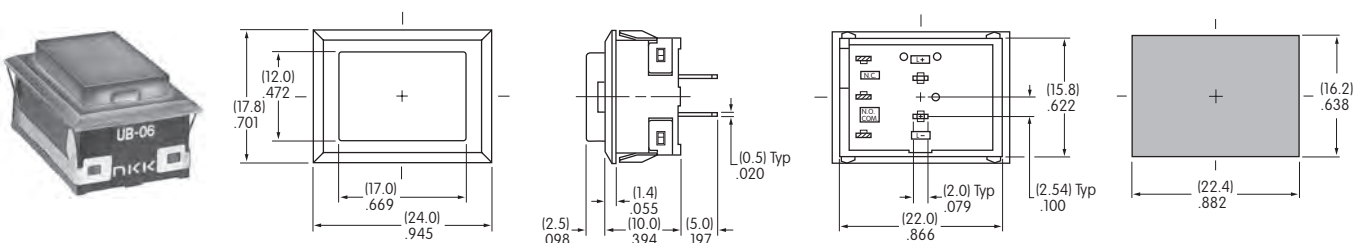

UB06KW015D-DD

Panel Thickness:  
1.0 ~ 3.2mm (.039 ~ .126")

### Rectangular • Snap-in Mount • Built-in Side Barriers

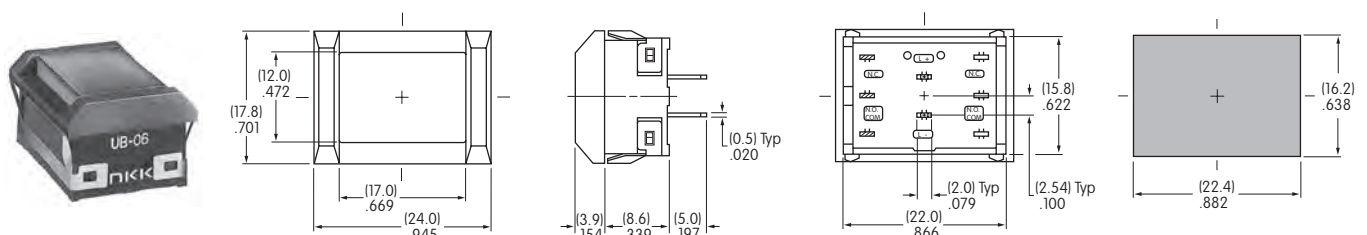

UB06BKW015F-FF

Panel Thickness:  
1.0 ~ 3.2mm (.039 ~ .126")

## TYPICAL INDICATOR DIMENSIONS

### Square • PCB Mount • Alternating Legends

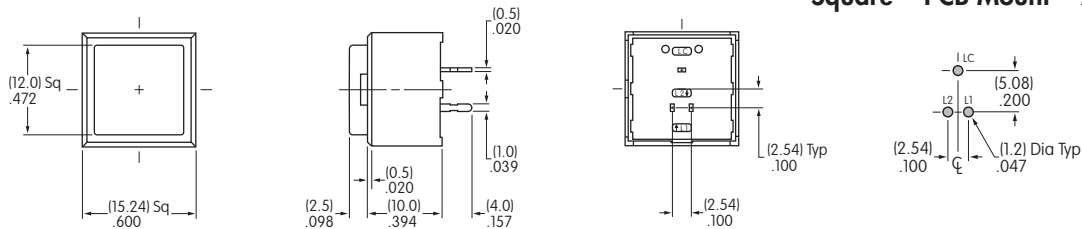

**UB01KW036DG-JDG11**

### Rectangular • PCB Mount • Alternating Legends

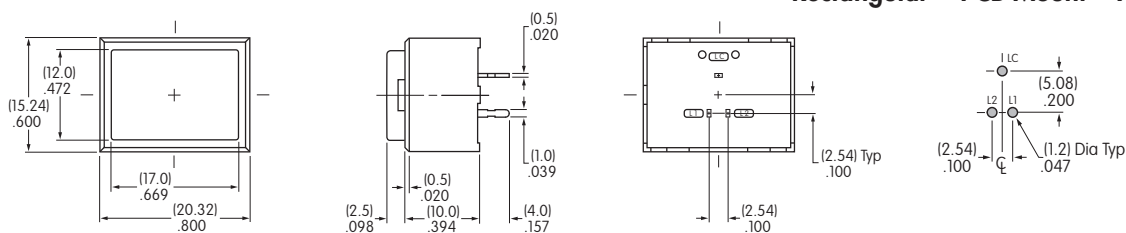

**UB03KW016DG-JDG11**

### Square • Snap-in Mount • Built-in Bezel • Alternating Legends

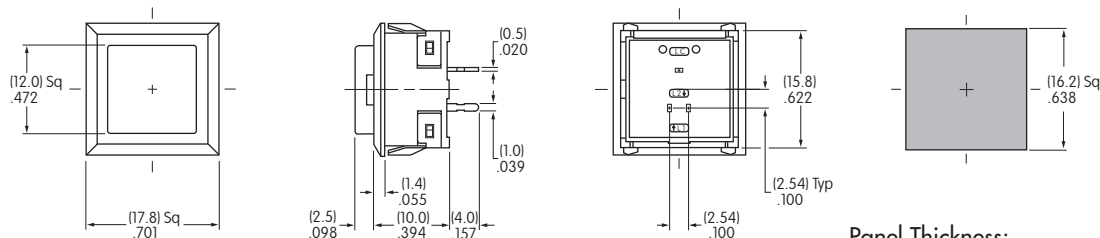

Panel Thickness:  
(1.0 ~ 3.2mm) .039 ~ .126" **UB04KW016DG-JDG11**

### Rectangular • Snap-in Mount • Built-in Bezel • Alternating Legends

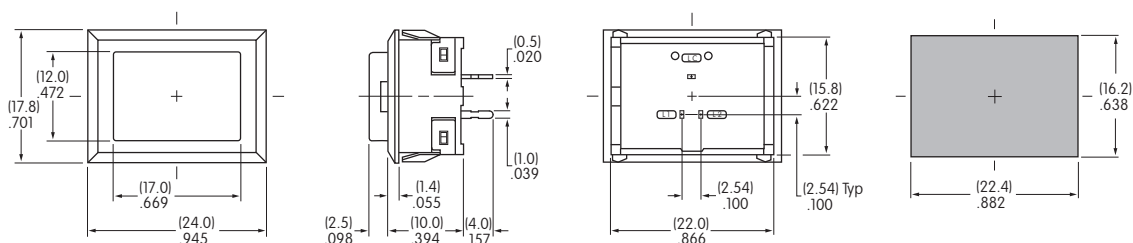

Panel Thickness:  
(1.0 ~ 3.2mm) .039 ~ .126" **UB06KW016DG-JDG11**

### Rectangular • Snap-in Mount • Built-in Side Barriers • Alternating Legends

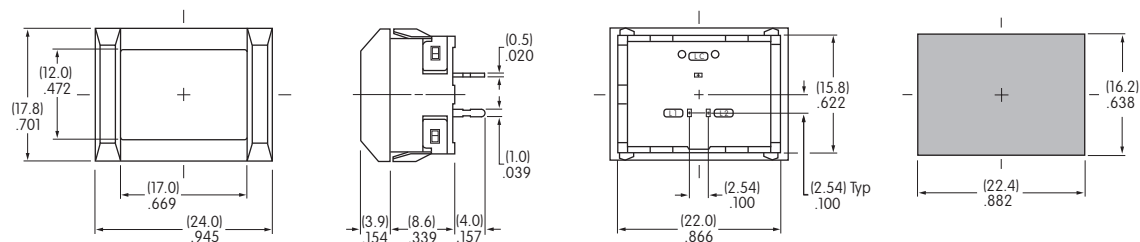

Panel Thickness:  
(1.0 ~ 3.2mm) .039 ~ .126" **UB06BKW016DG-JDG11**

### TYPICAL INDICATOR ORDERING EXAMPLE

**UB2**

**01**

**K**

**W03**

**6CF**

**1JB**



#### Mounting Types

##### PCB Mounting

**01** Square

##### Snap-in Mounting

**04** Square

#### Housing

**K** Black

#### Terminals

**W03** Silver PC/Turret

#### LEDs

##### Bright LED

<b>5C</b>	Red
<b>5D</b>	Amber
<b>5F</b>	Green

##### Super Bright LED

<b>6B</b>	White
<b>6F</b>	Green
<b>6G</b>	Blue

##### Super Bright Bicolor LED

<b>6CF</b>	Red/Green
<b>6DG</b>	Amber/Blue

#### Cap Types & Colors

##### Sculptured Cap Lens/Diffuser Colors

<b>1JB</b>	Clear/White
<b>1JC</b>	Clear/Red
<b>1JD</b>	Clear/Amber
<b>1JF</b>	Clear/Green

##### Beveled Cap & Colors

<b>2B</b>	White
<b>2C</b>	Red
<b>2D</b>	Amber
<b>2F</b>	Green

##### Flat Cap Lens/Diffuser Colors

<b>3JB</b>	Clear/White
<b>3JC</b>	Clear/Red
<b>3JD</b>	Clear/Amber
<b>3JF</b>	Clear/Green

##### Sculptured Cap Lens/Diffuser Color

<b>1JB</b>	Clear/White
------------	-------------

##### Beveled Cap & Color

<b>2B</b>	White
-----------	-------

##### Flat Cap Lens/Diffuser Color

<b>3JB</b>	Clear/White
------------	-------------

##### Sculptured Cap Lens/Diffuser Color

<b>1JB</b>	Clear/White
------------	-------------

##### Beveled Cap & Color

<b>2B</b>	White
-----------	-------

##### Flat Cap Lens/Diffuser Color

<b>3JB</b>	Clear/White
------------	-------------

##### Sculptured Cap with Alternating Legend

<b>4JCF</b>	Clear; Red/Green
<b>4JDG</b>	Clear; Amber/Blue

##### Flat Cap with Alternating Legend

<b>5JCF</b>	Clear; Red/Green
<b>5JDG</b>	Clear; Amber/Blue

#### Alternating Legends

<b>11</b>	ON (pos)	OFF (pos)
<b>12</b>	ON (neg)	OFF (neg)
<b>13</b>	START	STOP
<b>14</b>	OPEN	CLOSE

See Part Numbers Table on Next Page

#### DESCRIPTION FOR TYPICAL ORDERING EXAMPLE

**UB201KW036CF-1JB**

Sculptured Cap with Clear Lens, White Diffuser

Red/Green Super Bright Bicolor LED

Square with PCB Mounting



Black Housing

Silver PC/Turret Terminals

Toggles  
 Rockers  
 Pushbuttons  
 Illuminated PB  
 Programmable  
 Keylocks  
 Rotaries  
 Slides  
 Tactiles  
 Tilt  
 Touch  
 Indicators  
 Accessories  
 Supplement

Part Numbers for Alternating Legends		
Color	15mm Square Sculptured Cap	15mm Square Flat Cap
	Part Number	Part Number
Red/Green	AT3069JCF11 ~ AT3069JCF14	AT3070JCF11 ~ AT3070JCF14
Amber/Blue	AT3069JDG11 ~ AT3069JDG14	AT3070JDG11 ~ AT3070JDG14

Refer to Ordering Table for Alternating Legend that corresponds with last 2 digits of part number.

## MOUNTING TYPES, SHAPES, & TERMINALS

**01** PCB Mounting

Square

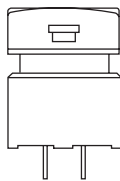

**04** Snap-in Mounting

Square with Built-in Bezel

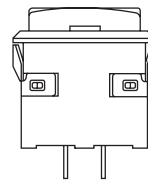

**W03** Terminals

Silver PC/Turret

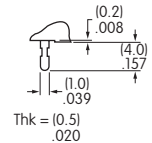

Panel Thickness: .039 ~ .126" (1.0 ~ 3.2mm)

## LED COLORS & SPECIFICATIONS

The electrical specifications shown are determined at a basic temperature of 25°C. Polarity marks are on the bottom of the device. If the source voltage exceeds the rated voltage, a ballast resistor is required. The resistor value can be calculated by using the formula in the Supplement section. The LED is an integral part of the indicator and not available separately.

Note for Super Bright: 		Bright			Super Bright			Super Bright Bicolor		Unit
		<b>5C</b>	<b>5D</b>	<b>5F</b>	<b>6B</b>	<b>6F</b>	<b>6G</b>	<b>6CF</b>	<b>6DG</b>	
Color		Red	Amber	Green	White	Green	Blue	Red/Green	Amber/Blue	
Maximum Forward Current	$I_{FM}$	30	30	25	20	30	30	30/25 *Amber 25/22	30/30	mA
Typical Forward Current	$I_F$	20	20	20	15	20	20	20/20	15/15	mA
Forward Voltage	$V_F$	1.85	2.0	2.1	3.3	3.5	3.6	2.1/3.5	2.0/2.8	V
Maximum Reverse Voltage	$V_{RM}$	5	5	5	5	5	5	4/4	4/4	V
Current Reduction Rate Above 25°C	$\Delta I_F$	0.40	0.42	0.46	0.25	0.50	0.50	0.40/0.33	0.33/0.33	mA/°C
Ambient Temperature Range		-25° ~ +50			-20° ~ +50			-25° ~ +50	-25° ~ +50	°C

Bright Single Color LED with 1 element 

Super Bright Single Color LED with 1 element 

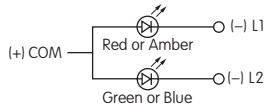
Super Bright Bicolor LED with 2 elements 

\*Amber color can be achieved by lighting red and green simultaneously on the bicolor LED (not suitable for Alternating Legends).

### CAP TYPES & COLOR COMBINATIONS

**1** AT3074  
Sculptured

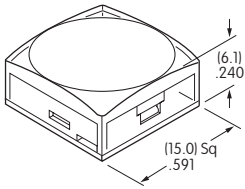

Lens/Diffuser Colors Available:

- JB** Clear/White
- JC** Clear/Red
- JD** Clear/Amber
- JF** Clear/Green

Material: Polycarbonate  
Finish: Glossy

**2** AT3075  
Beveled

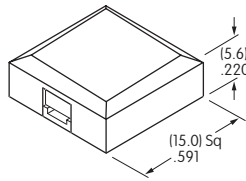

Material: Polycarbonate  
Finish: Glossy

Cap Colors Available:

- B** White
- C** Red
- D** Amber
- F** Green

**3** AT3076  
Flat

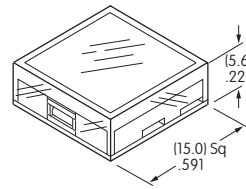

Material: Polycarbonate  
Finish: Glossy

Lens/Diffuser Colors Available:

- JB** Clear/White
- JC** Clear/Red
- JD** Clear/Amber
- JF** Clear/Green

### Alternating Legend Caps for Super Bright Bicolor LED

**AT3069J** Sculptured Cap with Alternating Legend

- 4JCF** Red/Green
- 4JDG** Amber/Blue

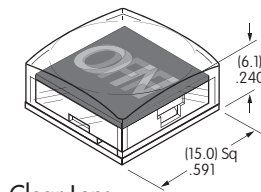

Clear Lens  
Alternating Legend Filter  
Material: Polycarbonate

**AT3070J** Flat Cap with Alternating Legend

- 5JCF** Red/Green
- 5JDG** Amber/Blue

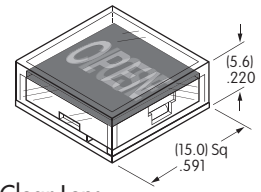

Clear Lens  
Alternating Legend Filter

### Standard Alternating Legend Pairs

- 11** ON OFF  
Green/Red or Blue/Amber
- 12** ON OFF  
Green/Red or Blue/Amber
- 13** START STOP  
Green/Red or Blue/Amber
- 14** OPEN CLOSE  
Green/Red or Blue/Amber

Cap illumination is alternating Green/Red or Blue/Amber; legend text is black. Contact factory for other Alternating Legends. Legend illustrations are approximate representations of the actual characters on the filters.

Note: Cap Removal Tool available for PCB Mount. See AT093ABC in Accessories & Hardware section for dimensions and other details.

### TYPICAL INDICATOR DIMENSIONS

#### PCB Mount

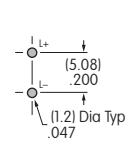
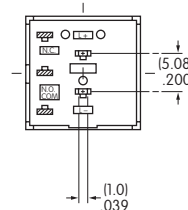
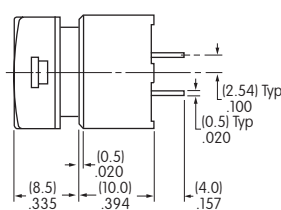
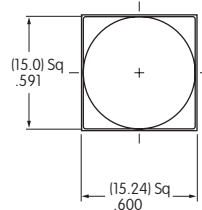

**UB201KW035C-1JC**

#### Snap-in Mount

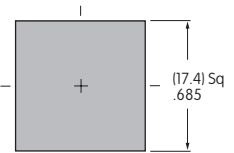
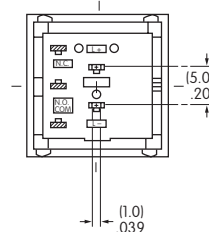
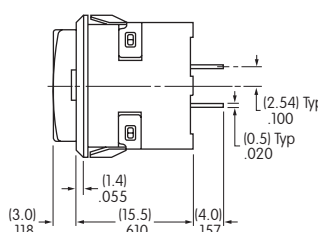
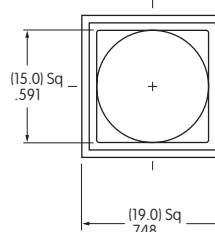

Panel Thickness:  
.039 ~ .126" (1.0 ~ 3.2mm)

Toggles  
Rockers  
Pushbuttons  
Illuminated PB  
Programmable  
Keylocks  
Rotaries  
Slides  
Tactiles  
Tilt  
Touch  
Indicators  
Accessories  
Supplement

## TYPICAL INDICATOR ORDERING EXAMPLE

**YB** **04** **K** **W01** — **12** — **FB**

### Shapes

Bushing Mounting	
01	Square
02	Round
03	Rectangular
Snap-in Mounting	
04	Square
05	Round
06	Rectangular

### Panel Seal

No Code	Without Panel Seal
W	With Panel Seal (Bushing Mount only)

### Housing

K	Black only
---	------------

### Terminals

W01	Silver Solder Lug/ .110" (2.8mm) Quick Connect
-----	--

### Lamps

Incandescent Lamp	
05	5-volt
12	12-volt

### Bright LED

LED Colors		Resistor	
5C	Red	No Code	No Resistor
5D	Amber	05	5-volt
		12	12-volt
5F	Green	24	24-volt

### Super Bright LED

6B	White
6F	Green
6G	Blue

### Bicolor LED

LED Colors		Forward Voltage	
2CF	Red/Green	02	2-volt (no resistor)
		05	5-volt
		12	12-volt
		24	24-volt

### Cap Types & Colors

Solid Cap: Lens/Insert Colors	
BB	White/White
CB	Red/White
EB	Yellow/White
FB	Green/White
GB	Blue/White

### LED Cap: Lens/Insert Colors

JB	Clear/White
JC	Clear/Red
JD	Clear/Amber
JF	Clear/Green

### LED Cap: Lens/Insert Colors

JB	Clear/White
----	-------------

### LED Cap: Lens/Insert Colors

JB	Clear/White
----	-------------

### DESCRIPTION FOR TYPICAL ORDERING EXAMPLE

**YB04KW01-12-FB**

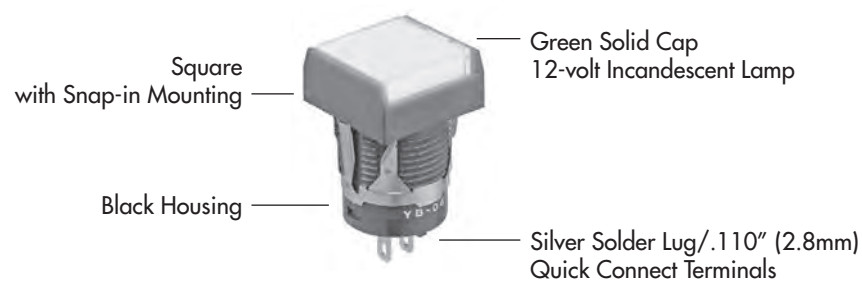

### SHAPES & MOUNTING TYPES

#### Bushing Mounting

#### Snap-in Mounting

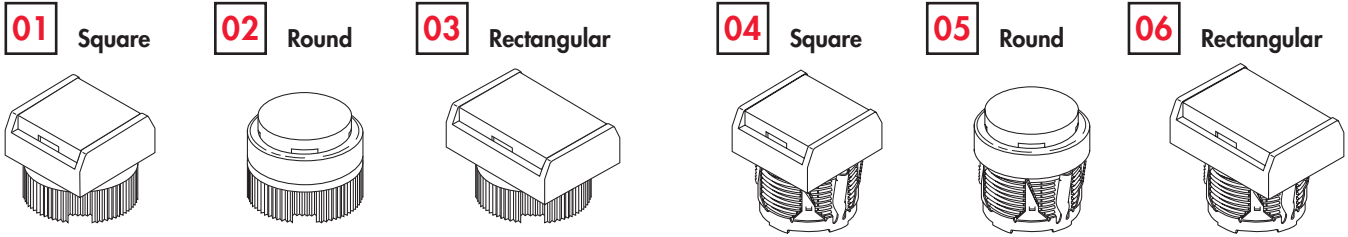

Bezel-barrier is an integral part of the indicator body.

### PANEL SEAL

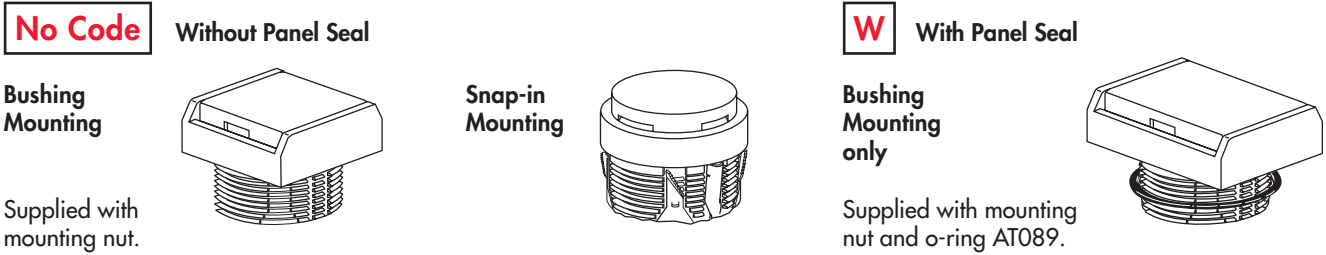

### INCANDESCENT LAMP & SOLID CAP

The electrical specifications shown are determined at a basic temperature of 25°C.  
If the source voltage exceeds the rated voltage, a ballast resistor is required.  
The resistor value can be calculated by using the formula in the Supplement section.

<b>AT611</b>  T-1 Bi-pin		<b>05</b>	<b>12</b>	
	Voltage	V	5V AC	12V AC
	Current	I	115mA	60mA
	MSCP		.150	.150
	Endurance	Hours	7,000 average	
	Ambient Temperature Range		-25°C ~ +50°C	

#### Solid Cap for Incandescent Lamp

Lens/Insert Colors Available:

- BB** White/White
- CB** Red/White
- EB** Yellow/White
- FB** Green/White
- GB** Blue/White

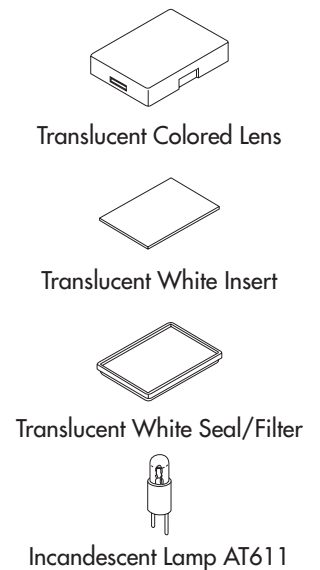
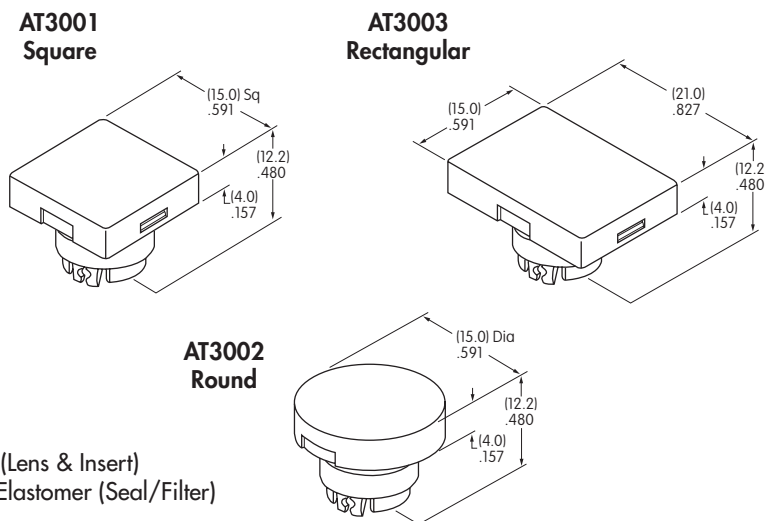

Materials: Polycarbonate (Lens & Insert)  
Thermoplastic Elastomer (Seal/Filter)  
Finish: Glossy

Toggles, Rockers, Pushbuttons, Illuminated PB, Programmable, Key locks, Rotaries, Slides, Tactiles, Tilt, Touch, Indicators, Accessories, Supplement



## BRIGHT LEDS & LED CAPS

The electrical specifications shown are determined at a basic temperature of 25°C.  
 If the source voltage exceeds the rated voltage, a ballast resistor is required.  
 The resistor value can be calculated by using the formula in the Supplement section.

### Electrical Specifications for Bright LED without Resistor

Bright AT628	Colors Available:	5C Red	5D Amber	5F Green	No Code	No Resistor	Unit
		Maximum Forward Current	$I_{FM}$	40	40	40	mA
	Typical Forward Current	$I_F$	26	26	26	mA	
	Forward Voltage	$V_F$	1.9	2.0	2.0	V	
	Maximum Reverse Voltage	$V_{RM}$	4	4	4	V	
	Current Reduction Rate Above 25°C	$\Delta I_F$	0.50			mA/°C	
	Ambient Temperature Range				-25 ~ +50	°C	

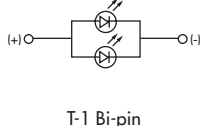

### Electrical Specifications for Bright LED with Resistor

Bright AT634	Colors Available:	5C Red	5D Amber	5F Green	05	12	24	Unit
		Maximum Forward Current	$I_{FM}$	—	—	—	—	mA
	Typical Forward Current	$I_F$	25	20	10	mA		
	Forward Voltage	$V_F$	5	12	24	V		
	Maximum Reverse Voltage	$V_{RM}$	4	8	16	V		
	Current Reduction Rate Above 25°C	$\Delta I_F$	—	—	—	mA/°C		
	Ambient Temperature Range				-25 ~ +50	°C		

AT634  
5-volt,  
2-element  
with Resistor

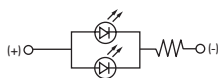

AT634  
12-volt,  
4-element  
with Resistor

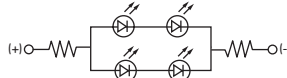

AT634  
24-volt,  
4-element  
with Resistor

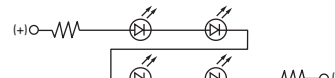

### Cap for Bright LED

Lens/Insert  
Colors Available:

- JB** Clear/White
- JC** Clear/Red
- JD** Clear/Amber
- JF** Clear/Green

**AT3004**  
Square

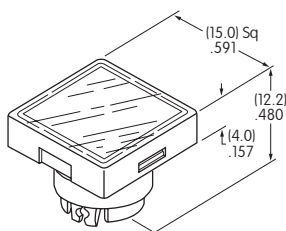

**AT3006**  
Rectangular

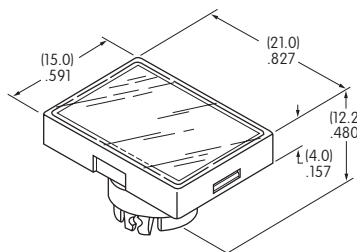

**AT3005**  
Round

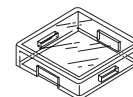
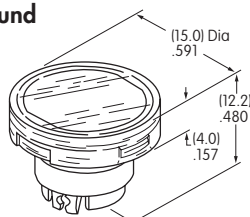

Transparent Clear Lens

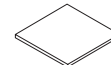

Translucent Colored Insert

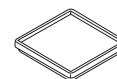

Translucent White Seal/Diffuser





Bright LEDs  
AT628 AT634

Materials: Polycarbonate (Lens & Insert)  
 Thermoplastic Elastomer (Seal/Diffuser)  
 Finish: Glossy

Toggles  
Rocker  
Pushbuttons  
Illuminated PB  
Programmable  
Key locks  
Rotaries  
Slides  
Tactiles  
Tilt  
Touch  
Indicators  
Accessories  
Supplement

### SUPER BRIGHT LEDS & LED CAPS

The electrical specifications shown are determined at a basic temperature of 25°C.  
 If the source voltage exceeds the rated voltage, a ballast resistor is required.  
 The resistor value can be calculated by using the formula in the Supplement section.

 <p>Super Bright                  AT625G Blue                  AT631B White                  AT632F Green</p> <p>T-1 Bi-pin</p>	 	<div style="border: 1px solid black; padding: 2px; display: inline-block; color: red; font-weight: bold;">6B</div>	<div style="border: 1px solid black; padding: 2px; display: inline-block; color: red; font-weight: bold;">6F</div>	<div style="border: 1px solid black; padding: 2px; display: inline-block; color: red; font-weight: bold;">6G</div>		
	Colors:	White	Green	Blue	Unit	
	Maximum Forward Current	$I_{FM}$	30	30	30	mA
	Typical Forward Current	$I_F$	20	20	20	mA
	Forward Voltage	$V_F$	3.3	3.3	3.3	V
	Maximum Reverse Voltage	$V_{RM}$	7	7	7	V
	Current Reduction Rate Above 25°C	$\Delta I_F$	0.40	0.40	0.40	mA/°C
Ambient Temperature Range		-25 ~ +50			°C	

### Cap for Super Bright LED

**AT3014**  
Square

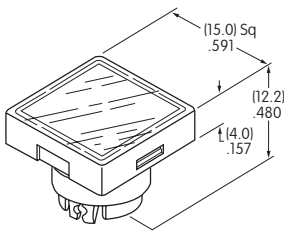

**AT3015**  
Round

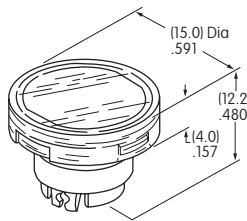

**AT3016**  
Rectangular

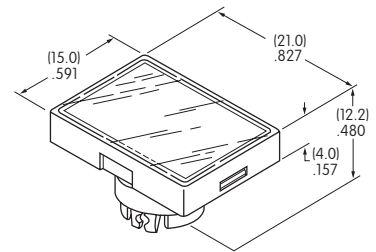

Lens/Insert  
 Colors Available:

**JB** Clear/White

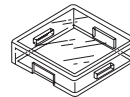

Transparent Clear Lens

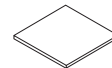

Translucent White Insert

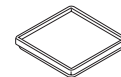

Translucent White Seal/Diffuser





Super Bright LEDs  
 AT625 AT631  
 AT632

Materials: Polycarbonate (Lens & Insert)  
 Thermoplastic Elastomer (Seal/Diffuser)

BICOLOR LED & LED CAPS

The electrical specifications shown are determined at a basic temperature of 25°C.  
 If the source voltage exceeds the rated voltage, a ballast resistor is required.  
 The resistor value can be calculated by using the formula in the Supplement section.

<b>Bicolor AT621</b>  Red/Green  T-1 1/2 Bi-pin	Bicolor LED is translucent white in OFF state.	<b>02</b>	<b>05</b>	<b>12</b>	<b>24</b>	Unit
	Maximum Forward Current $I_{FM}$	60	60	20	12	mA
	Typical Forward Current $I_F$	45	45	15	10	mA
	Forward Voltage (Red/Green) $V_F$	1.9 / 2.1	5	12	24	V
	Current Reduction Rate Above 25°C $\Delta I_F$	0.80	----	----	----	mA/°C
	Ambient Temperature Range		-25 ~ +50			°C

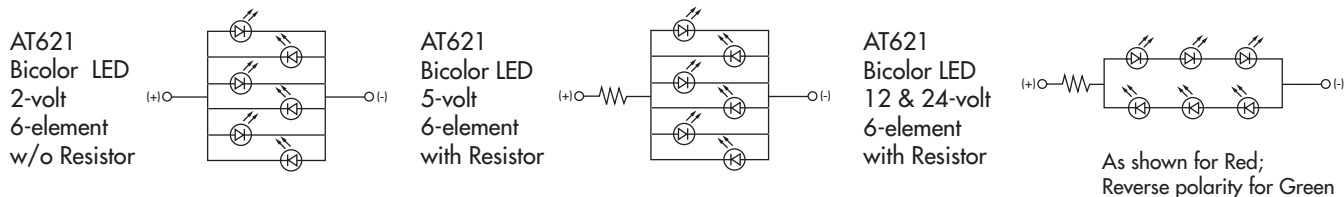

LED Caps

AT3004 Square

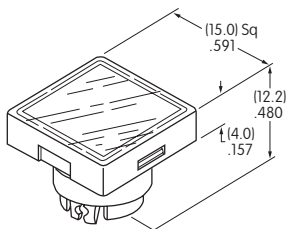

AT3005 Round

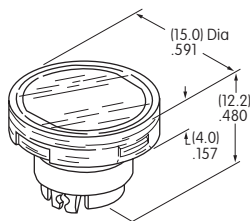

AT3006 Rectangular

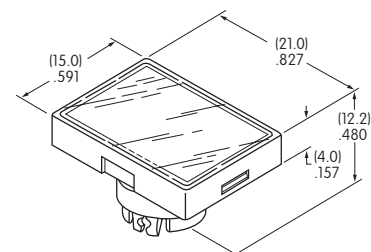

Lens/Insert Colors Available:

**JB** Clear/White

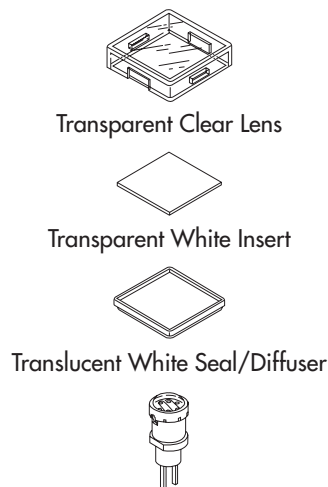

Materials: Polycarbonate (Lens & Insert)  
 Thermoplastic Elastomer (Seal/Diffuser)

### TYPICAL INDICATOR DIMENSIONS

#### Square • Bushing Mounting

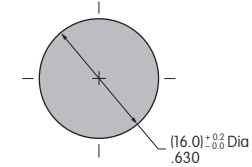
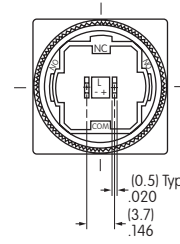
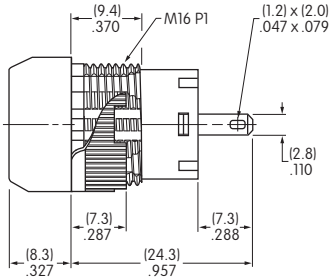
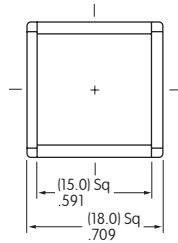

**YB01KW01-12-CB**

Panel Thickness  
.020" ~ .197" (0.5mm ~ 5.0mm)

#### Round • Panel Seal

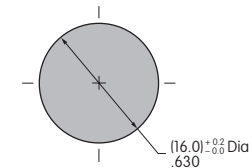
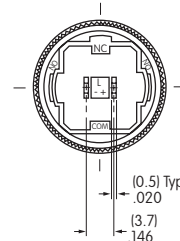
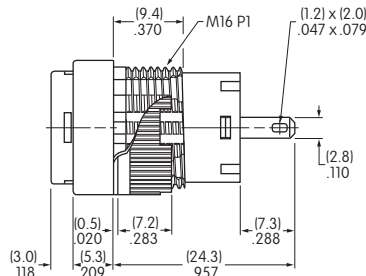
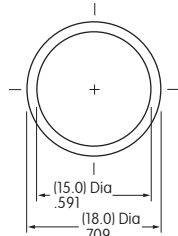

**YB02WKW01-12-GB**

Panel Thickness  
.020" ~ .197" (0.5mm ~ 5.0mm)

#### Rectangular • Snap-in Mounting

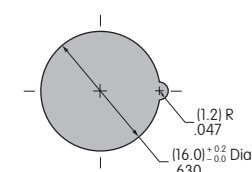
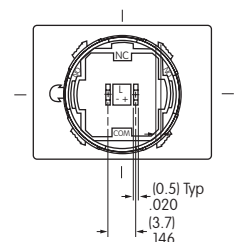
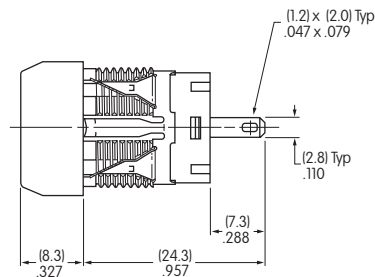
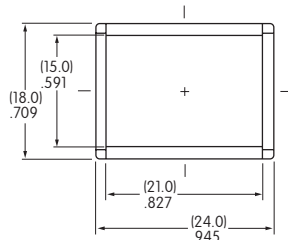

**YB06KW01-12-EB**

Panel Thickness  
.039" ~ .138" (1.0mm ~ 3.5mm)



# Accessories & Hardware

# Accessories & Hardware

## Contents

Part Number	Page
AT001s .....	Y3
AT100s .....	Y5
AT200s .....	Y6
AT400s .....	Y8
AT500s .....	Y13
AT600s .....	Y16
AT700s .....	Y18
AT2100s .....	Y19
AT3000s .....	Y19
AT4000s .....	Y23
AT4100s .....	Y27
AT9000s .....	Y34

## Color Codes

<b>A</b> Black	<b>D</b> Amber	<b>G</b> Blue	<b>P</b> Brushed Chrome
<b>B</b> White	<b>E</b> Yellow	<b>H</b> Gray	<b>S</b> Metallic Silver
<b>C</b> Red	<b>F</b> Green	<b>J</b> Clear	

## Hardware Threading

Many hardware pieces are available in both metric and inch threading, and in such cases **M** (metric) and **H** (inch) are noted in the descriptions. The customer must select threading by placing an M or H after the basic AT part number. If the hardware is available only in metric or inch, no code is used in the description; threading is designated on the drawing.

# Accessories & Hardware

AT010s~  
AT090s

**AT016**  
16mm Hex Mounting Nut  
Steel with nickel plating  
Series: CKM LP01



**AT019**  
19mm Hex Mounting Nut  
Steel with nickel plating  
Series: CKL

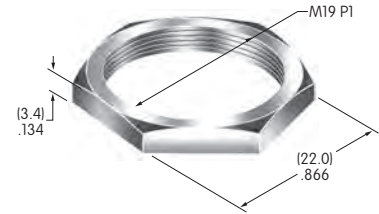

**AT055**  
Crossover Guard  
Polypropylene  
Series: KB

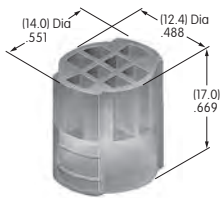

**AT056**  
Dress Cap Nut  
Brass with chrome plating  
Series: M P S

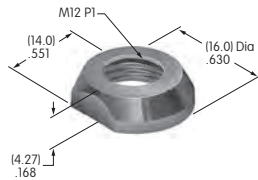

**AT056T**  
Threaded Through Dress Nut  
Brass with chrome plating  
Series: M P S

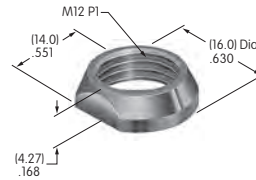

**AT057**  
Mounting Nut  
Brass with zinc plating,  
chromate finish  
Series: KB

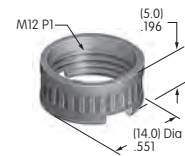

**AT062**  
.250" Wide Rocker  
Polyamide  
Colors: A B C  
Series: A

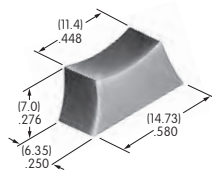

**AT063**  
Gasket  
Nitrile butadiene rubber  
Color: A  
Series: B Threaded Bushing

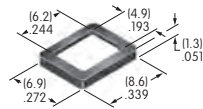

**AT064-1**  
Panel Frame for Rocker &  
Paddle .365" Wide  
Polyamide  
Color: A  
Series: M

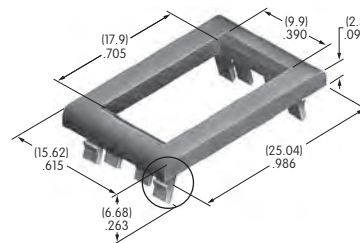

**AT064-2**  
Panel Frame for Rocker &  
Paddle .365" Wide  
Polyamide  
Color: A  
Series: M

AT064-1 accommodates  
panel thickness  
1.2 ~ 2.3mm  
(.047 ~ .090")



AT064-2 accommodates  
panel thickness  
1.57 ~ 3.18mm  
(.062 ~ .125")



Color Codes: A Black B White C Red D Amber E Yellow F Green G Blue H Gray J Clear

# Accessories & Hardware

Toggle

Rockers

Pushbuttons

Illuminated PB

Programmable

Keylocks

Rotaries

Slides

Tactiles

Tilt

Touch

Indicators

Accessories

Supplement

**AT065-1**  
**Panel Frame for Rocker & Paddle .450" Wide**  
 Polyamide  
 Color: A  
 Series: M

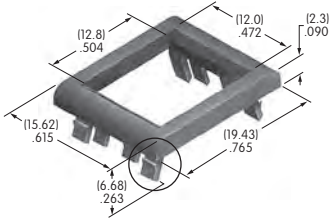

AT065-1 accommodates panel thickness 1.2 ~ 2.3mm (.047 ~ .090")



**AT065-2**  
**Panel Frame for Rocker & Paddle .450" Wide**  
 Polyamide  
 Color: A  
 Series: M

**AT066**  
**.300" Wide Rocker**  
 Polyamide  
 Color: A B C  
 Series: A

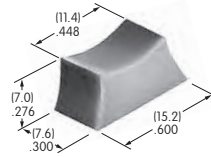

AT065-2 accommodates panel thickness 1.57 ~ 3.18mm (.062 ~ .125")



**AT070**  
**LED for AT208 Bezel**  
 Colors: C F  
 Series: EB M MB24

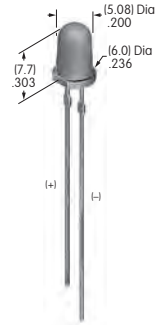

**AT073**  
**Mounting Nut**  
 Brass with nickel plating  
 Series: HB



**AT074**  
**Mounting Nut for LB Panel Seal**  
 Brass with chromate  
 Series: LB

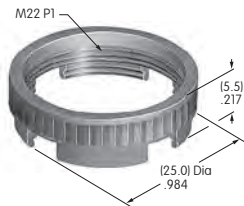

**AT075**  
**O-ring for LB Panel Seal**  
 Nitrile butadiene rubber  
 Series: LB

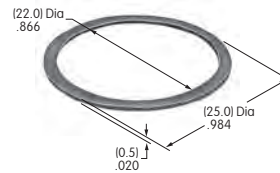

**AT078**  
**.315" (8.0mm) Diameter Screw-on Cap**  
 Polystyrene  
 Colors: A B C E F G H  
 Series: MB20 SCB WB

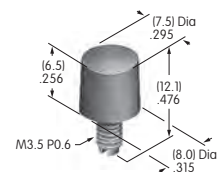

**AT079**  
**.394" (10.0mm) Diameter Screw-on Cap**  
 Polystyrene  
 Colors: A B C E F G H  
 Series: MB20 SCB WB

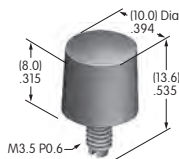

**AT080**  
**Screw Adaptor for AT452 & AT454**  
 Brass  
 Series: MB20 SCB

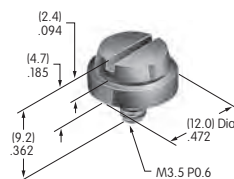

**AT089**  
**O-ring for YB Panel Seal**  
 Nitrile butadiene rubber  
 Series: YB

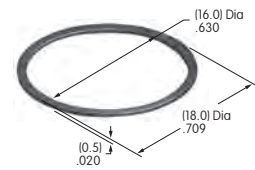

**Color Codes:** A Black B White C Red D Amber E Yellow F Green G Blue H Gray J Clear



# Accessories & Hardware

## AT092

**Knurled Mounting Nut**  
Glass fiber reinforced PBT  
Series: YB YB2 (Square)



## AT094

**PC Adaptor**  
Holder: Polypropylene  
Spring: Spring steel with nickel plating  
PC Pins: Brass with nickel plating  
Series: DSA01

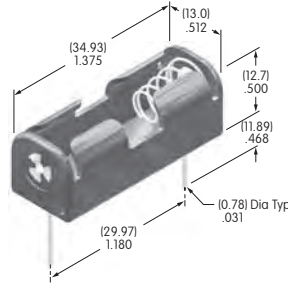

## AT097

**JST Connector for OLED Rocker**  
JST Part No. BM12B-SURS  
PCB Mount  
Series: SmartSwitch

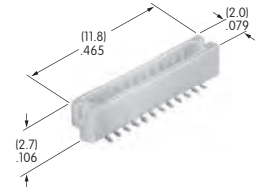

## AT100s

### AT105

**Cap Removal Tool**  
Stainless steel  
Series: HB KB LB UB YB

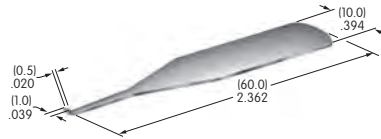

### AT106

**Socket Wrench**  
Aluminum with black alumite finish  
Series: YB YB2

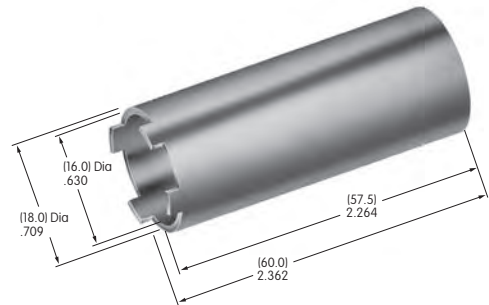

## AT107

**Lamp Extractor**  
Polyvinyl chloride  
Series: KB LW MLW YB



## AT108

**Socket Wrench**  
Aluminum with black alumite finish  
Series: KB

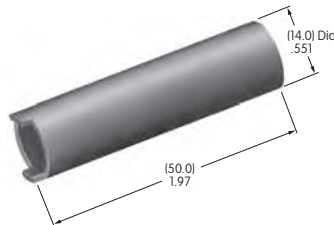

## AT109

**Cap Extractor**  
Stainless steel  
Series: HB KB LB UB YB

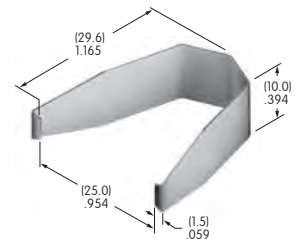

Color Codes: A Black B White C Red D Amber E Yellow F Green G Blue H Gray J Clear

# Accessories & Hardware

Toggle

Rockers

Pushbuttons

Illuminated PB

Programmable

Keylocks

Rotaries

Slides

Tactiles

Tilt

Touch

Indicators

Accessories

Supplement

**AT110**  
Socket Wrench  
Brass  
Series: HB

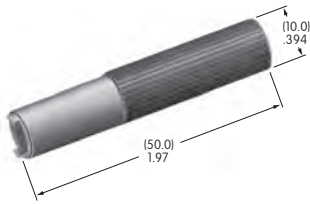

**AT111**  
Lamping Tool  
Stainless steel  
Series: HB KB YB

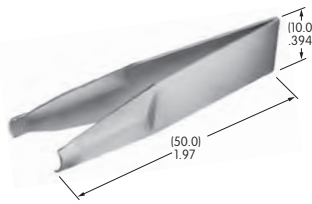

**AT112**  
Socket Wrench  
Brass with nickel plating  
Series: LB

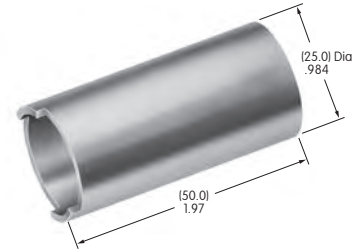

## AT200s

**AT201**  
ON-OFF Plate for  
12mm Threaded Bushing  
Brass with nickel plating  
Series: M P S

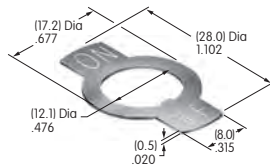

**AT202**  
ON-OFF Plate for  
12mm Threaded Bushing  
Aluminum  
Colors: Red & black enamel  
Series: M P S

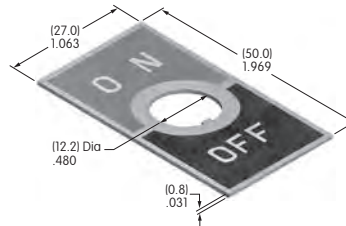

**AT204**  
Bezel  
Polycarbonate  
Colors: A B C D E F G H  
Series: MLW

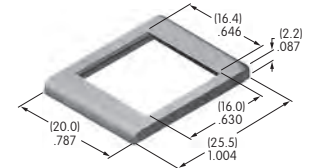

**AT206**  
Bezel  
Polycarbonate  
Colors: A B C D E F G H  
Series: LW

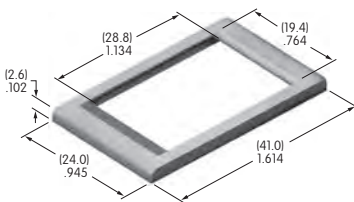

**AT207**  
Bezel  
Polycarbonate  
Colors: A B C E F G H  
Series: EB MB24 MB25

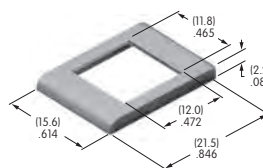

**AT208**  
Bezel for AT070 LED  
Polycarbonate  
Color: A  
Series: EB M MB24 MB25

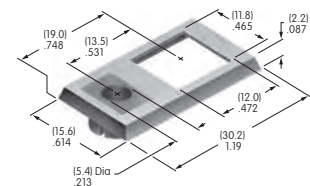

**Color Codes:** A Black B White C Red D Amber E Yellow F Green G Blue H Gray J Clear

# Accessories & Hardware

**AT209**  
**ON-OFF Plate for 6mm Threaded Bushing**  
 Brass with nickel plating  
 Series: M P

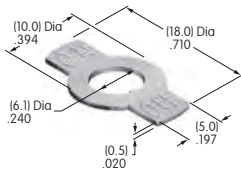

**AT210**  
**ON-OFF Plate for 6mm Threaded Bushing**  
 Aluminum  
 Colors: Red & black ink  
 Series: M P

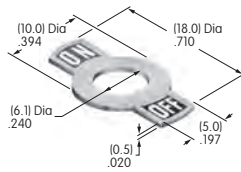

**AT211**  
**ON-OFF Plate for 6mm Threaded Bushing**  
 Aluminum  
 Colors: Red & black enamel  
 Series: M P

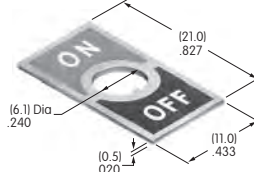

**AT212**  
**Bezel for 2 AT617 LEDs**  
 Polycarbonate  
 Color: A  
 Series: EB M MB24 MB25

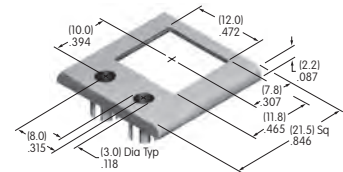

**AT213**  
**Bezel for 2 AT618 LEDs**  
 Polycarbonate  
 Color: A  
 Series: EB M MB24 MB25

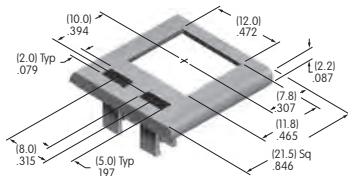

**AT214**  
**ON-OFF Plate for 12mm Threaded Bushing**  
 Aluminum  
 Colors: Red & black ink  
 Series: M P S

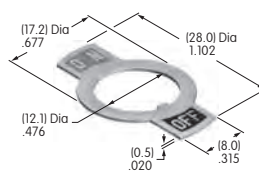

**AT215**  
**ON-OFF Plate for 12mm Threaded Bushing**  
 Aluminum  
 Colors: Red & black enamel  
 Series: M P S

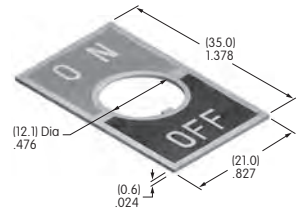

**AT217**  
**Barrier**  
 Polyamide  
 Colors: A B H  
 Series: JWM

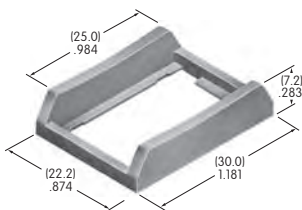

**AT218**  
**Barrier**  
 Polyamide  
 Colors: A B H  
 Series: JWL

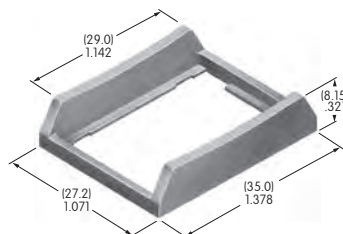

**AT219**  
**Barrier**  
 Polyamide  
 Colors: A  
 Series: JWS

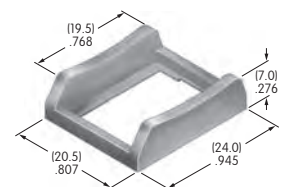

Color Codes: A Black B White C Red D Amber E Yellow F Green G Blue H Gray J Clear

# Accessories & Hardware

## AT400s

### AT401A/H/S

#### Splashproof Boot Assembly

Hex Nut Material & Finish:  
Nickel plated brass  
O-ring Material:  
Nitrile butadiene rubber  
Series: M P S WT

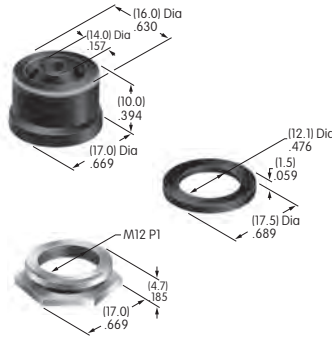

### AT401A for Oil Resistance

Boot Material: Black nitrile butadiene rubber

### AT401H for Dust & Ozone Resistance

Boot Material: Gray ethylene propylene rubber

### AT401S for Flexibility, Resilience, and Tensile Strength over Wide Temperature Range

Boot Material: Black silicone rubber

### For 12mm Bushings in M, P, S and WT Toggles

#### Boot Assembly Instructions

1. After mounting boot AT401 over toggle, press into place.
2. Be sure boot is pressed evenly and firmly down at or below height (A) as shown.

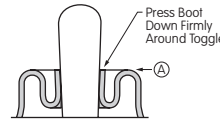

#### Switch Installation Instructions

1. Install switch bushing into mounting hole of panel from the back and adjust bushing to protrude 3.5 ~ 5.5mm (.138 ~ .217") above panel.
2. Install boot over bushing and tighten with hex nut.

#### Non-Splashproof Switches

##### M, P or S Toggles with 12mm Bushings

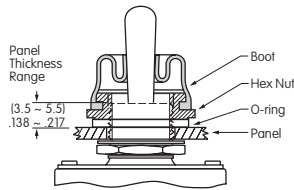

Use boot, nut and o-ring as shown. Use lockwasher and hexagon nut (from standard switch hardware) behind panel.

#### Splashproof Switches

##### S1AW ~ S29AW S Toggles

##### WT Toggles or M Toggle with B3 Bushing

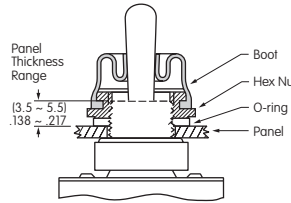

Use boot, nut and o-ring as shown. Use o-ring only (from standard switch hardware) behind panel.

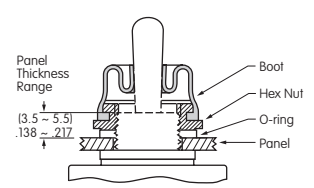

### AT401P

#### O-ring

Nitrile butadiene rubber  
Color: A  
Series: M MB20 TL WB WT

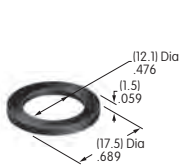

### AT402

#### Splashproof Boot

Silicon rubber for A C E F  
Ethylene propylene rubber for H  
Colors: A C E F H  
Series: M P S

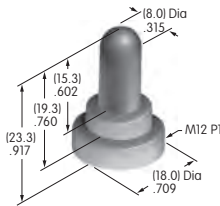

### AT402S

#### Splashproof Boot

Silicon rubber  
Color: A  
Series: M

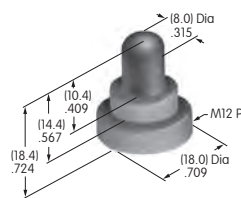

### AT405

#### Solid Color Rocker

Polycarbonate  
Colors: A B C D E F G  
Series: MLW

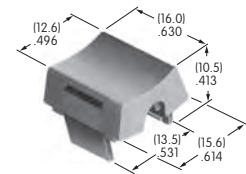

Color Codes: A Black B White C Red D Amber E Yellow F Green G Blue H Gray J Clear

Toggles  
Rockers  
Pushbuttons  
Illuminated PB  
Programmable  
Keylocks  
Rotaries  
Slides  
Tactiles  
Tilt  
Touch  
Indicators  
Accessories  
Supplement

# Accessories & Hardware

## AT406

**Bat Lever Cap**  
 Polyvinyl chloride  
 Colors: A B C E F G  
 Series: M P S



## AT407

**.394" Diameter Screw-on Cap**  
 PBT  
 Colors: A B C E F G H  
 Series: MB20



## AT412

**.748" Diameter Screw-on Cap**  
 Polystyrene  
 Colors: A B C F  
 Series: MB20 SCB WB

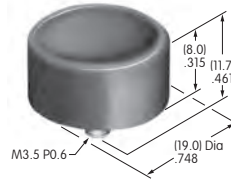

## AT413

**.315" Diameter Screw-on Cap**  
 PBT  
 Colors: A B C E F G H  
 Series: MB20

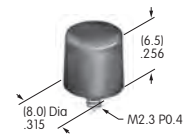

## AT414

**.520" Diameter Screw-on Cap**  
 PBT  
 Colors: A B C D E F G H  
 Series: MB20 SB SCB WB

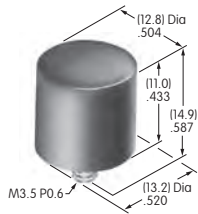

## AT415

**Bat Lever Cap**  
 Polyethylene  
 Colors: A B C E F G  
 Series: D2 M

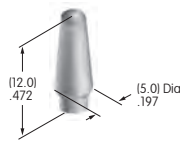

## AT416

**Lamp Cover for AT602**  
 Silicon rubber  
 Colors: C D F  
 Series: LW

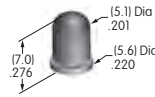

## AT420

**Rocker**  
 Polycarbonate  
 Colors: B J  
 Series: LW

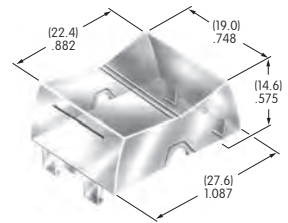

## AT421

**Filter for AT420**  
 Polycarbonate  
 Colors: B C D E F G  
 Series: LW

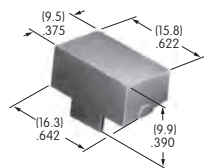

## AT422

**Slip-on Cap**  
 Polyethylene  
 Colors: A B C E F G  
 Series: SB40



## AT426

**Solid Color Paddle**  
 Polycarbonate  
 Colors: A B C D E F G  
 Series: MLW

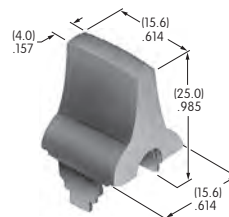

## AT427

**Cap for Locking Lever (code L)**  
 Brass with bright nickel plating (supplied with switch)  
 Anodized aluminum  
 Colors: A C G  
 Series: D2 M

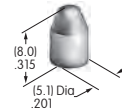

Color Codes: A Black B White C Red D Amber E Yellow F Green G Blue H Gray J Clear

# Accessories & Hardware

Toggle

Rockers

Pushbuttons

Illuminated PB

Programmable

Keylocks

Rotaries

Slides

Tactiles

Tilt

Touch

Indicators

Accessories

Supplement

**AT428 (M-metric H-inch)**  
**Splashproof Boot**  
 Silicone rubber  
 Color: A  
 Series: D2 M P

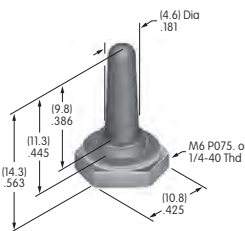

**AT429**  
**Indicator Cap**  
 Polycarbonate  
 Colors: B C D E F G  
 Series: P01



**AT431**  
**Large Rotary Knob**  
 Phenolic resin  
 Color: A  
 Series: HS PS TS

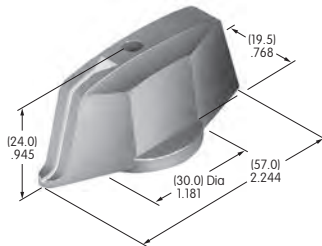

**AT432**  
**Small Rotary Knob**  
 Phenolic resin  
 Color: A  
 Series: HS PS TS

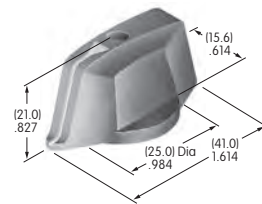

**AT433**  
**Knob for Miniature Rotaries**  
 Polyacetal  
 Color: A  
 Series: FR01 MR

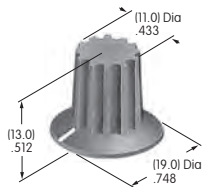

**AT434**  
**Bat Lever Cap**  
 Polyvinyl chloride  
 Colors: A B C E F G  
 Series: M



**AT435**  
**Screw-on Cap**  
 Brass with chrome plating  
 Series: SB265

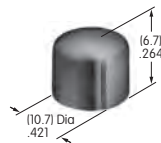

**AT438**  
**Design Rocker**  
 Polycarbonate  
 Colors: B C D F G  
 Series: MLW

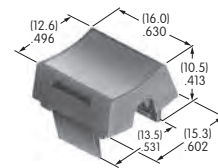

**AT442**  
**.394" Diameter Snap-on Cap**  
 Polycarbonate  
 Colors: A B C E F G H  
 Series: DB EB M2B MB20 MB25



**AT443**  
**.315" Diameter Snap-on Cap**  
 Polycarbonate  
 Colors: A B C E F G H  
 Series: DB EB M2B MB20 MB25



**AT444**  
**Bat Lever Conical Cap**  
 Polyethylene  
 Colors: A B C E F G  
 Series: D2 M M2T

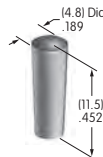

**AT445**  
**Cap for Color Tipped Cone Toggle**  
 Polycarbonate  
 Colors: A B C  
 Series: M



**Color Codes:** A Black B White C Red D Amber E Yellow F Green G Blue H Gray J Clear

# Accessories & Hardware

## AT452

**Rectangular Insert**  
Polycarbonate  
Colors: A B C F G H  
Series: MB20 SCB  
Used with Screw Adaptor AT080

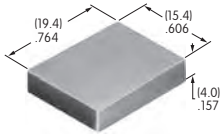

## AT453

**Rectangular Shroud**  
Polycarbonate  
Colors: A B H  
Series: MB20 SCB

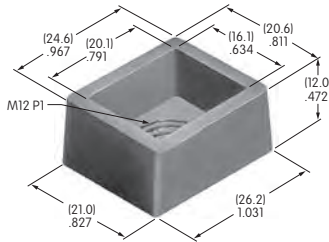

## AT454

**Round Insert**  
Polycarbonate  
Colors: A B C F G H  
Series: MB20 SCB  
Used with Screw Adaptor AT080



## AT455

**Round Shroud**  
Polycarbonate  
Colors: A B H  
Series: MB20 SCB

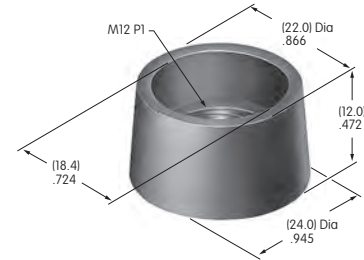

## AT460

**Cap for Color Capped Cone Toggle**  
Polyethylene  
Colors: A B C E F G  
Series: M

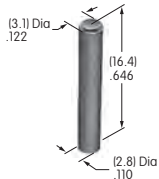

## AT465

**.453" Square Cap**  
Polycarbonate  
Colors: A B C E F G H  
Series: EB MB24 MB25

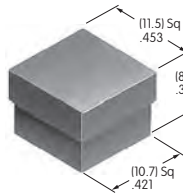

## AT466

**.453" False Illuminated Rocker**  
Polycarbonate  
Cap Color: A  
Window Color: B/C  
Series: M

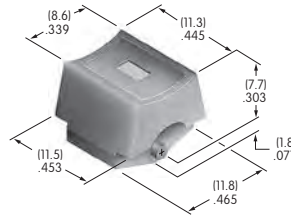

## AT467

**Short Paddle**  
Polyamide  
Colors: A B C E F G H  
Series: A

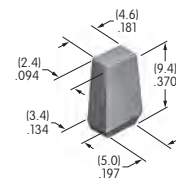

## AT468

**Long Paddle**  
Polyamide  
Colors: A B C E F G H  
Series: A

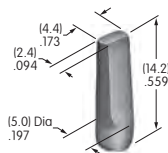

## AT469

**.260" Wide Rocker**  
Polyamide  
Colors: A B C E F G H  
Series: A



## AT475

**.201" Diameter Cap**  
Polyamide  
Colors: A B C  
Series: AB BB FB M2B MB24



## AT476

**Square Solid Colored Cap**  
Polycarbonate  
Colors: BJ CJ EJ FJ GJ  
Series: LB

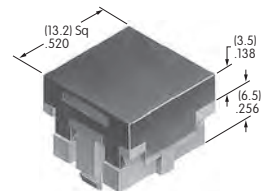

Color Codes: A Black B White C Red D Amber E Yellow F Green G Blue H Gray J Clear

# Accessories & Hardware

Toggles

Rockers

Pushbuttons

Illuminated PB

Programmable

Keylocks

Rotaries

Slides

Tactiles

Tilt

Touch

Indicators

Accessories

Supplement

**AT477**  
**Square Colored Insert Cap**  
 Polycarbonate  
 Colors: JB JC JE JF JG  
 Series: LB

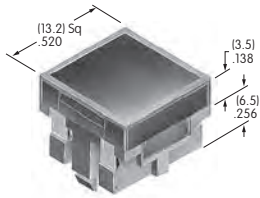

**AT480**  
**Square Spot Illuminated Cap**  
 Polycarbonate  
 Cap Colors: A B C F  
 LED Colors: C D F CF  
 Series: LB

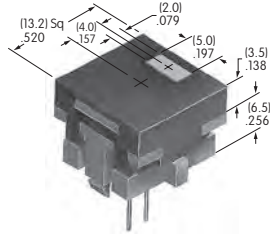

**AT484**  
**Square Nonilluminated Cap**  
 Polycarbonate  
 Colors: A B C E F G H  
 Series: LB

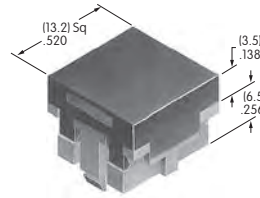

**AT485**  
**Square Solid Colored Cap**  
 Polycarbonate  
 Colors: A BB CB CC EB  
 FB FF GB GG  
 Series: KB



**AT486**  
**Round Solid Colored Cap**  
 Polycarbonate  
 Colors: A BB CB CC EB  
 FB FF GB GG  
 Series: KB



**AT487**  
**Square Colored Insert Cap**  
 Polycarbonate  
 Colors: JB JC JE JF JG  
 Series: KB



**AT488**  
**Round Colored Insert Cap**  
 Polycarbonate  
 Colors: JB JC JE JF JG  
 Series: KB



**AT494**  
**Protective Guard**  
 Cover: Polycarbonate  
 Base: Polyamide  
 Series: KB

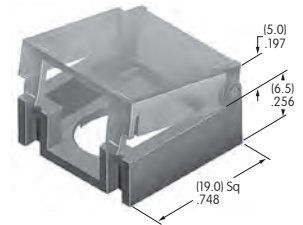

**AT495**  
**Dust Cover**  
 Lid: Polyvinyl chloride  
 Base: Polyamide  
 Series: KB

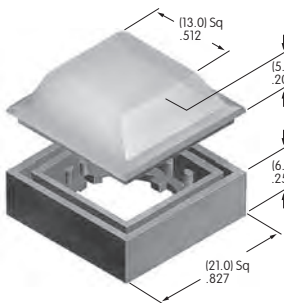

**AT496**  
**.295" Diameter Cap**  
 Polyamide  
 Colors: A B C  
 Series: AB BB FB M2B MB24



**AT497**  
**End Barrier**  
 Polyamide  
 Color: A  
 Series: LB

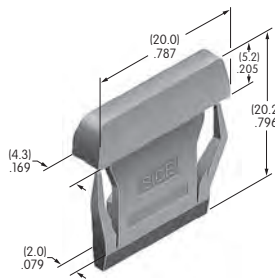

**AT498**  
**Center Barrier**  
 Polyamide  
 Color: A  
 Series: LB

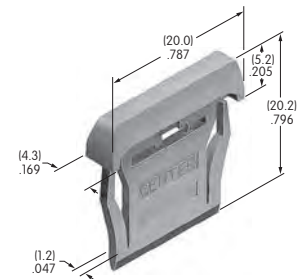

**Color Codes:** A Black B White C Red D Amber E Yellow F Green G Blue H Gray J Clear



# Accessories & Hardware

**AT499**  
**Protective Guard for Square**  
 Cover: Polycarbonate  
 Base: Polyamide  
 Series: LB

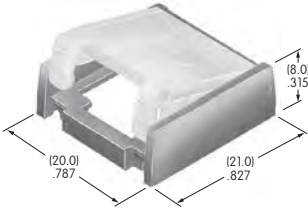

## AT500s

**AT501 (M-metric H-inch)**  
**Knurled Face Nut**  
 Brass with chrome plating  
 Series: D2 DB EB M MB20  
 MB24 P

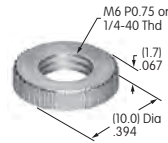

**AT503 (M-metric H-inch)**  
**Hex Face Nut**  
 Brass with chrome plating  
 Series: M P S SB WB WT

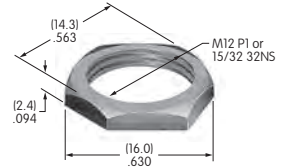

**AT504M**  
**Knurled Face Nut**  
 Brass with chrome plating  
 Series: M P S SB SCB  
 WB WT

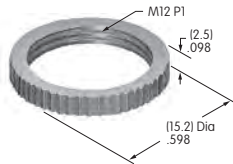

**AT506M**  
**Locking Ring**  
 Steel with zinc/chromate  
 Series: M MB20 P S SB

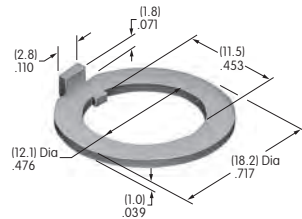

**AT507 (M-metric H-inch)**  
**Locking Ring**  
 Steel with zinc/chromate  
 Series: D2 DB EB M MB20  
 MB24 MB25 MR P

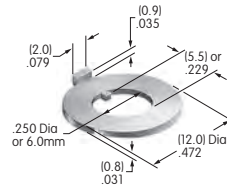

**AT508**  
**Internal Tooth Lockwasher**  
 Steel with zinc/chromate  
 Series: M P S SB SCB  
 SK TL WB WT

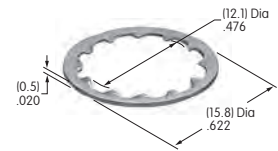

**AT509**  
**Internal Tooth Lockwasher**  
 Steel with zinc/chromate  
 Series: D2 DB EB FR01 M  
 MB25 MR P S SB

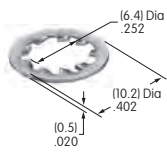

**AT512 (M-metric H-inch)**  
**Conical Nut**  
 Brass with chrome plating  
 Series: EB MB20

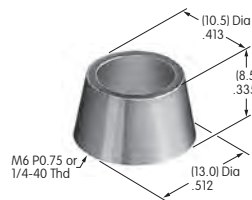

**AT512C (M-metric H-inch)**  
**Conical Nut**  
 Brass with chrome plating  
 Series: EB MB20



**AT513H**  
**Hex Nut**  
 Brass with nickel plating  
 Series: M MB20 MB24

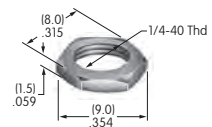

**Color Codes:** A Black B White C Red D Amber E Yellow F Green G Blue H Gray J Clear

# Accessories & Hardware

Toggle

Rockers

Pushbuttons

Illuminated PB

Programmable

Keylocks

Rotaries

Slides

Tactiles

Tilt

Touch

Indicators

Accessories

Supplement

## AT513M

### Hex Nut

Brass with nickel plating  
Series: B D2 DB EB FR01 M  
MB20 MB25 MR P

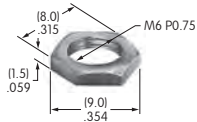

## AT515 (M-metric H-inch)

### Locking Ring for D Flat Bushing

Steel with zinc/chromate  
Series: FR01 M MB24

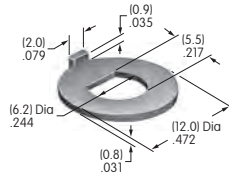

## AT516

### O-ring

Nitrile butadiene rubber  
Series: M MB20

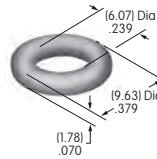

## AT518

### Locking Ring

Steel with zinc/chromate  
Series: HS PS TS

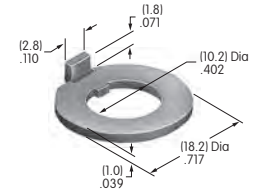

## AT520

### Split Lockwasher

Steel with zinc/chromate  
Series: HS PS TS



## AT526

### Hex Mounting Nut

Steel with nickel plating  
Series: HS PS TS



## AT527 (M-metric H-inch)

### Hex Mounting Nut

Steel with nickel plating  
Series: M P S SB SCB  
SK TL

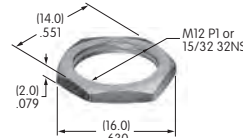

## AT527MA

### Black Hex Face Nut

Steel with black chrome plating  
Series: TL

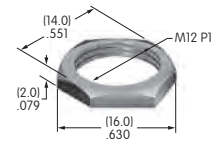

## AT529

### Mounter for Square Cap

Stainless steel frame  
GFR PBT spacer  
Series: EB

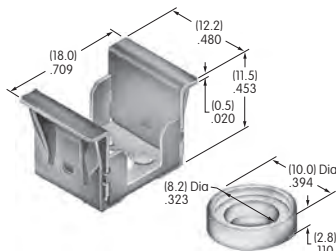

## AT530

### Panel Mount for Single Pole

Polyamide & polyacetel  
Colors: A B C E F G H  
Series: A AB

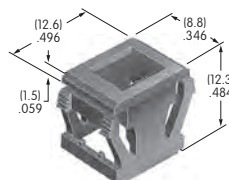

## AT531

### Panel Mount for Single or Double Pole

Polyamide & polyacetel  
Colors: A B C E F G H  
Series: A AB

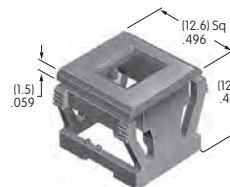

## AT532 (M-metric H-inch)

### Dress Cap Nut

Brass with nickel plating  
Series: EB M MB20 MB24 P

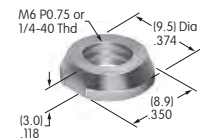

Color Codes:

A Black

B White

C Red

D Amber

E Yellow

F Green

G Blue

H Gray

J Clear

# Accessories & Hardware

**AT532T (M-metric H-inch)**  
**Threaded Through Dress Nut**  
 Brass with nickel plating  
 Series: EB M MB20 MB24 P

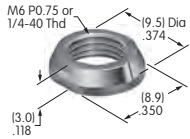

**AT533T (M-metric H-inch)**  
**Threaded Through Dress Nut**  
 Brass with nickel plating  
 Series: EB M MB20 MB24 P

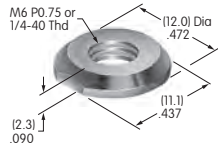

**AT535**  
**Rubber Ring for MR Panel Seal**  
 Nitrile butadiene rubber  
 Series: MRB MRK

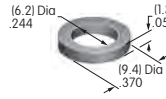

**AT536**  
**Hex Nut**  
 Brass with nickel plating  
 Series: FB

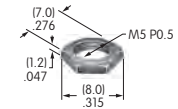

**AT537**  
**O-ring**  
 Nitrile butadiene rubber  
 Series: S

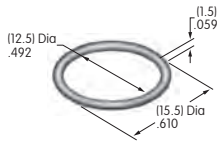

**AT541**  
**O-ring for Panel Seal with AT4115**  
 Nitrile butadiene rubber  
 Series: YB

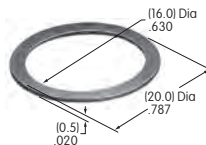

**AT542**  
**Coupler for LCD 36 x 24 Pushbutton**  
 PBT  
 Series: SmartSwitch

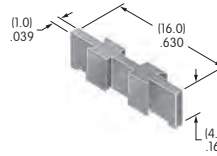

**AT543**  
**Support Bracket**  
 Steel with tin plating  
 Series: MRK

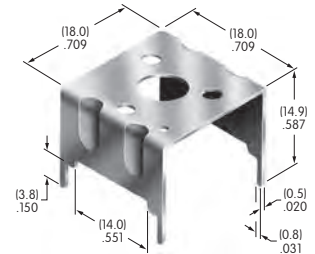

**AT545**  
**Locking Ring**  
 Steel with zinc/chromate  
 Series: MRA MRB MRK

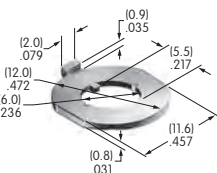

**AT546**  
**Mounting Bracket for Block Mounting**  
 Phosphor bronze with tin plating  
 Series: GB2

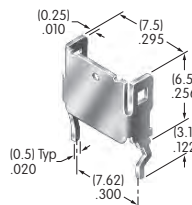

**AT547**  
**Mounter for AT4140**  
 Polyamide  
 Color: A  
 Series: JB

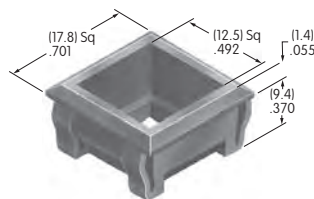

**AT548**  
**Panel Mount Housing for LCD 36 x 24 Pushbutton**  
 (not for Compact SmartSwitch)  
 Polyamide  
 Color: A  
 Series: SmartSwitch

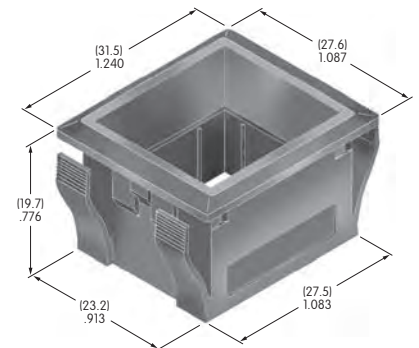

**Color Codes:** A Black B White C Red D Amber E Yellow F Green G Blue H Gray J Clear

# Accessories & Hardware

Toggles

Rockers

Pushbuttons

Illuminated PB

Programmable

Keylocks

Rotaries

Slides

Tactiles

Tilt

Touch

Indicators

Accessories

Supplement

## AT600s

**AT602**  
**Incandescent Lamp**  
 Volts: 6 12 18 24 28  
 Series: LW MLW  
 T-1½ Pilot Slide Base

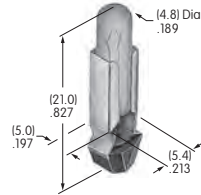

**AT602N**  
**Neon Lamp**  
 Volts: 110  
 Series: LW MLW  
 T-1½ Pilot Slide Base

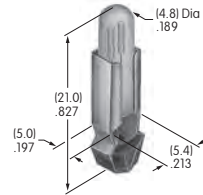

**AT607**  
**Incandescent Lamp**  
 Volts: 5 12  
 Series: LB  
 T-1 Bi-pin

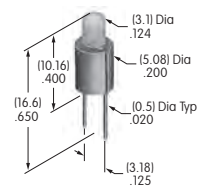

**AT607N**  
**Neon Lamp**  
 Volts: 110  
 Series: LB  
 T-1 Bi-pin

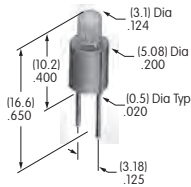

**AT611**  
**Incandescent Lamp**  
 Volts: 5 12  
 Series: KB YB  
 T-1 Bi-pin

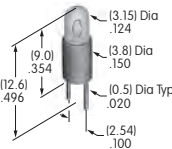

**AT615**  
**Neon Lamp**  
 Volts: 110  
 Series: KB  
 T-1 Bi-pin

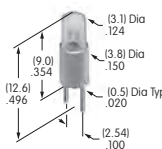

**AT617**  
**Single Element LED**  
 Colors: C E F  
 Used for AT212 Bezel

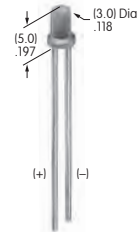

**AT618**  
**Single Element LED**  
 Colors: C E F  
 Used for AT213 Bezel

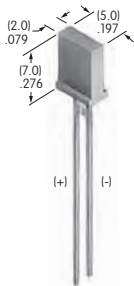

**AT621**  
**6-element Bicolor LED**  
 Without Resistor; Volts: 2  
 With Resistor; Volts: 5 12 24  
 Colors: CF  
 Series: YB  
 T-1½ Bi-pin

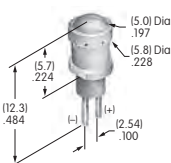

**AT622**  
**Single Element LED**  
 Colors: C E F  
 Series: MLW  
 T-1¾ Pilot Slide Base



**AT624**  
**Single Element LED**  
 Color: G  
 Series: HB  
 T-1 Bi-pin

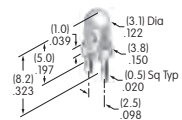

**Color Codes:** A Black B White C Red D Amber E Yellow F Green G Blue H Gray J Clear

# Accessories & Hardware

## AT625

**Super Bright  
Single Element LED**  
Color: G  
Series: KB LB YB YB2  
T-1 Bi-pin

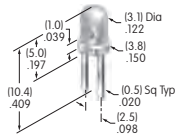

## AT627

**Bright  
4-Element LED**  
With Resistor; Volts: 5 12 24  
Colors: C D F  
Series: LB  
T-1 Bi-pin

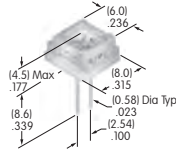

## AT628

**Bright  
Double Element LED**  
Colors: C D F  
Series: YB YB2  
T-1 Bi-pin

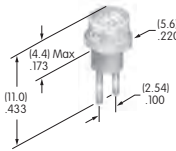

## AT629

**Single Element LED**  
Color: B  
Series: HB  
T-1 Bi-pin

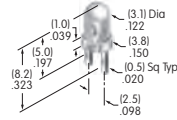

## AT630

**Single Element LED**  
Color: F  
Series: HB  
T-1 Bi-pin

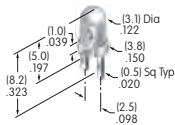

## AT631

**Super Bright  
Single Element LED**  
Color: B  
Series: KB LB YB YB2  
T-1 Bi-pin

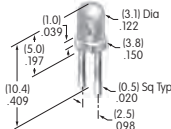

## AT632

**Super Bright  
Single Element LED**  
Color: F  
Series: KB LB YB YB2  
T-1 Bi-pin

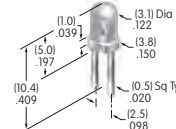

## AT633

**Single Element LED**  
Colors: C D F  
Series: HB  
T-1 Bi-pin

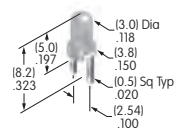

## AT634

**Bright  
2- or 4-Element LED**  
With Resistor; Volts: 5 12 24  
Colors: C D F  
Series: KB YB YB2  
T-1 1/4 Bi-pin

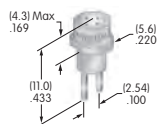

## AT635

**Bright  
Single Element LED**  
Colors: C D F  
Series: KB LB  
T-1 1/2 Bi-pin

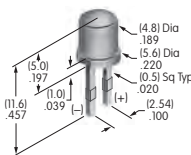

## AT636

**Bright  
Single Element LED**  
With Resistor; Volts: 5 12 24  
Color: F  
Series: YB2  
T-1 1/4 Bi-pin

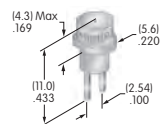

Color Codes: A Black B White C Red D Amber E Yellow F Green G Blue H Gray J Clear

# Accessories & Hardware

Toggles

Rockers

Pushbuttons

Illuminated PB

Programmable

Keylocks

Rotaries

Slides

Tactiles

Tilt

Touch

Indicators

Accessories

Supplement

## AT700s

**AT701**  
**Single Pole**  
**Straight PC Adaptor**  
 Glass fiber reinforced polyamide  
 Series: KB

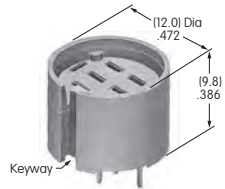

**AT702**  
**Double Pole**  
**Straight PC Adaptor**  
 Glass fiber reinforced polyamide  
 Series: KB

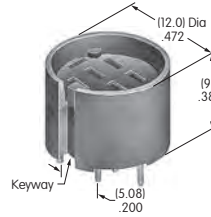

**AT711**  
**Single Pole**  
**Straight PC Adaptor**  
 Glass fiber reinforced polyamide  
 Series: LB

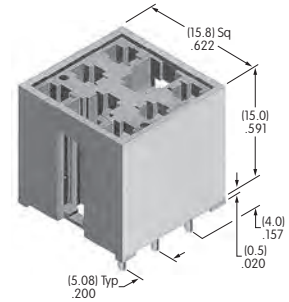

**AT712**  
**Double Pole**  
**Straight PC Adaptor**  
 Glass fiber reinforced polyamide  
 Series: LB

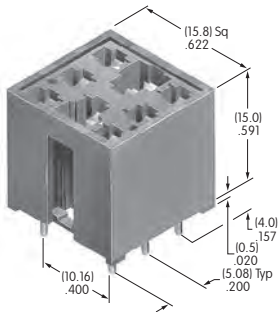

**AT713**  
**Receptacle Connector**  
 Connects to RS232C  
 Compatible with  
 FTCS04B & FTCS05B (5-wire) or  
 FTCS04A & FTCS04A2 (4 wire)  
 Length: 19.7" (500.0mm)  
 Series: FT



**AT714**  
**Receptacle Connector**  
 Connects to Power Source  
 of Control Boards  
 FTCS04B & FTCS05B (5-wire)  
 Length: 19.7" (500.0mm)  
 Series: FT



**AT715**  
**Connector Cable**  
 Cable for OLED Rocker  
 Length: 19.7" (500.0mm)  
 Series: SmartSwitch



**AT716**  
**Single Pole Solder Lug/**  
**Quick Connect Adaptor**  
 Glass fiber reinforced polyamide  
 Series: LP01, YB, YB2

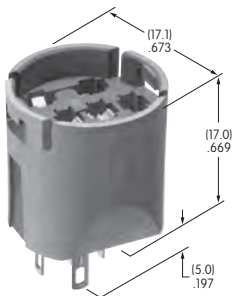

**AT717**  
**Double Pole Solder Lug/**  
**Quick Connect Adaptor**  
 Glass fiber reinforced polyamide  
 Series: LP01, YB, YB2

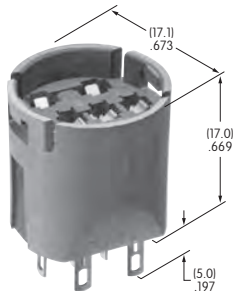

**AT718**  
**Single Pole**  
**Straight PC Adaptor**  
 Glass fiber reinforced polyamide  
 Series: LP01, YB, YB2

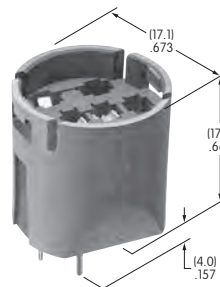

**AT719**  
**Double Pole**  
**Straight PC Adaptor**  
 Glass fiber reinforced polyamide  
 Series: LP01, YB, YB2

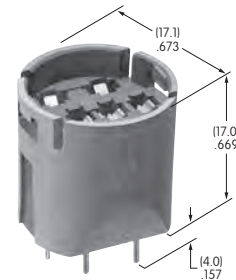

**Color Codes:** A Black B White C Red D Amber E Yellow F Green G Blue H Gray J Clear

# Accessories & Hardware

Toggle

Rockers

Pushbuttons

Illuminated PB

Programmable

Keylocks

Rotaries

Slides

Tactiles

Tilt

Touch

Indicators

Accessories

Supplement

## AT2100s

**AT2107**  
**Bezel**  
 Polyamide  
 Colors: A B E F G H  
 Series: M M2100

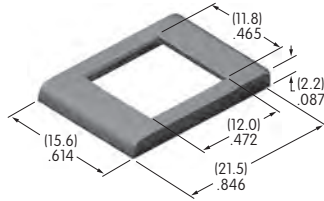

## AT3000s

**AT3001**  
**Square Solid Cap**  
 Polycarbonate  
 Colors: BB CB EB FB GB  
 Series: YB

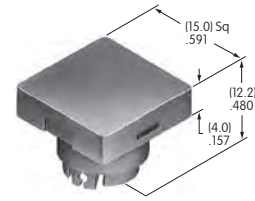

**AT3002**  
**Round Solid Cap**  
 Polycarbonate  
 Colors: BB CB EB FB GB  
 Series: YB

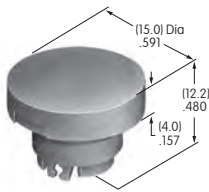

**AT3003**  
**Rectangular Solid Cap**  
 Polycarbonate  
 Colors: BB CB EB FB GB  
 Series: YB

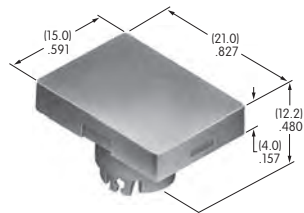

**AT3004**  
**Square Cap for Bright LED & Bicolor**  
 Polycarbonate  
 Colors: JB JC JD JF  
 Series: YB

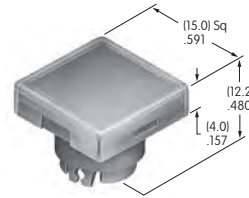

**AT3005**  
**Round Cap for Bright LED & Bicolor**  
 Polycarbonate  
 Colors: JB JC JD JF  
 Series: YB

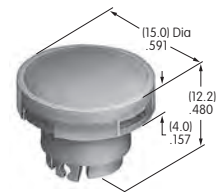

**AT3006**  
**Rectangular Cap for Bright LED & Bicolor**  
 Polycarbonate  
 Colors: JB JC JD JF  
 Series: YB

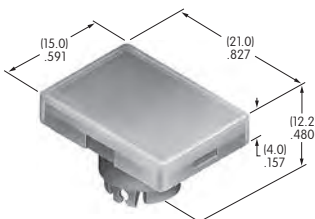

**AT3010**  
**Square Spot Illuminated Cap with Built-in LED**  
 Without Resistor; Volts: 2  
 With Resistor; Volts: 5 12 24  
 Polycarbonate  
 Cap Colors: JA JB JC JE JF  
 LED Colors: C D F CF  
 Series: YB

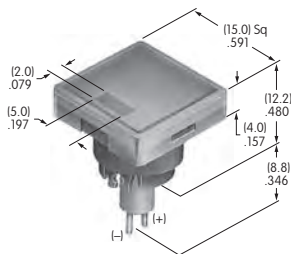

**AT3011**  
**Round Spot Illuminated Cap with Built-in LED**  
 Without Resistor; Volts: 2  
 With Resistor; Volts: 5 12 24  
 Polycarbonate  
 Cap Colors: JA JB JC JE JF  
 LED Colors: C D F CF  
 Series: YB

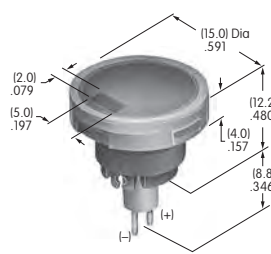

**AT3012**  
**Rectangular Spot Illuminated Cap with Built-in LED**  
 Without Resistor; Volts: 2  
 With Resistor; Volts: 5 12 24  
 Polycarbonate  
 Cap Colors: JA JB JC JE JF  
 LED Colors: C D F CF  
 Series: YB

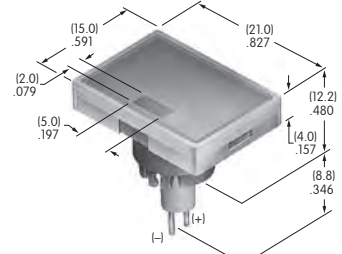

Color Codes: A Black B White C Red D Amber E Yellow F Green G Blue H Gray J Clear

# Accessories & Hardware

Toggle

Rockers

Pushbuttons

Illuminated PB

Programmable

Keylocks

Rotaries

Slides

Tactiles

Tilt

Touch

Indicators

Accessories

Supplement

**AT3014**  
**Square Cap for Super Bright LED**  
 Polycarbonate  
 Color: JB  
 Series: YB

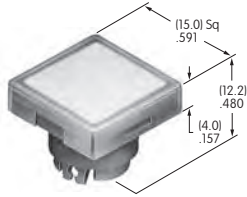

**AT3015**  
**Round Cap for Super Bright LED**  
 Polycarbonate  
 Color: JB  
 Series: YB

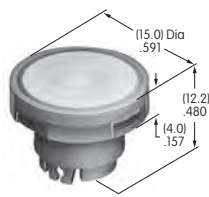

**AT3016**  
**Rectangular Cap for Super Bright LED**  
 Polycarbonate  
 Color: JB  
 Series: YB

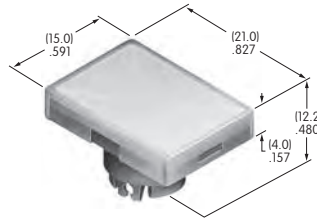

**AT3017**  
**Round Cap for Bright LED or Nonilluminated**  
 Polycarbonate  
 HB Lens: ABS Resin & Unbrushed Chrome Plating  
 Colors: JB CB EB FB HB  
 Series: YB2



**AT3018**  
**Round Cap for Super Bright LED**  
 Polycarbonate  
 HB Lens: ABS Resin & Unbrushed Chrome Plating  
 Colors: JB HB  
 Series: YB2



**AT3019**  
**Round Solid Cap for Nonilluminated**  
 ABS Resin & Brushed Chrome Plating  
 Color: P (Brushed Chrome)  
 Series: YB2

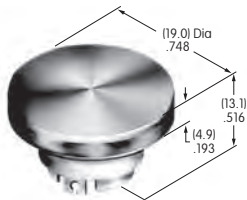

**AT3020**  
**Round Cap with Clear Illumination Ring for Bright or Super Bright LED**  
 Lens: Polycarbonate  
 Insert: Polyester  
 Color: JS (Metallic Silver with Clear Ring)  
 Series: YB2



**AT3021**  
**Flat Cap for Barrier Flange**  
 Polyphenylene oxide  
 Colors: A B C H  
 Series: JP

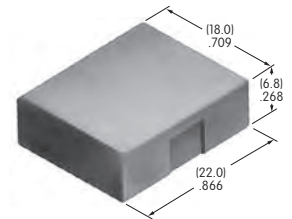

**AT3022**  
**Square Cap for Single or Bicolor LED**  
 Polycarbonate Resin  
 Colors: JB JC JD JF  
 Series: NP01



**AT3023**  
**Square Cap for Bicolor LED with Alternating Legends**  
 Polycarbonate Resin  
 Color: J  
 Series: NP01

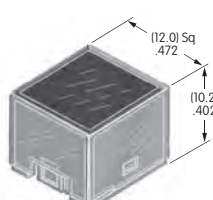

**AT3024**  
**Square Solid Cap**  
 Polycarbonate Resin  
 Colors: A B C H  
 Series: NP01

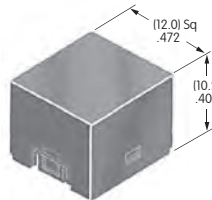

**AT3025**  
**Square Cap for Bright & Super Bright LED or Nonilluminated**  
 Polycarbonate  
 Colors: JB CB EB FB HB  
 Series: YB2

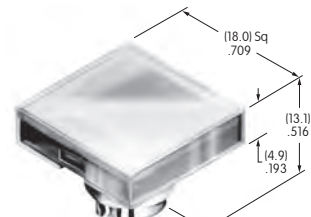

**Color Codes:** A Black B White C Red D Amber E Yellow F Green G Blue H Gray J Clear



# Accessories & Hardware

## AT3027

**Square Solid Cap for Nonilluminated**  
 ABS Resin & Brushed Chrome Plating  
 Color: P (Brushed Chrome)  
 Series: YB2

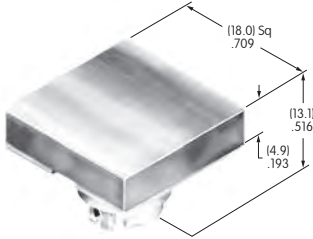

## AT3069

**Sculptured Cap with Alternating Legend for Illuminated**  
 Polycarbonate  
 Color: J  
 Series: UB2

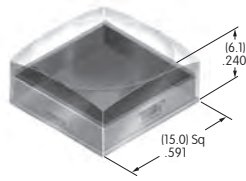

## AT3070

**Flat Cap with Alternating Legend for Illuminated**  
 Polycarbonate  
 Color: J  
 Series: UB2

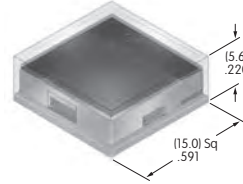

## AT3073

**Sculptured Cap for Nonilluminated**  
 Polycarbonate  
 Colors: JA JB JC JD JF  
 Series: UB2



## AT3074

**Sculptured Cap for Illuminated**  
 Polycarbonate  
 Colors: JB JC JD JF  
 Series: UB2

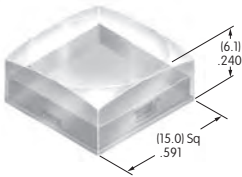

## AT3075

**Beveled Cap for Illuminated**  
 Polycarbonate  
 Colors: B C D F  
 Series: UB2

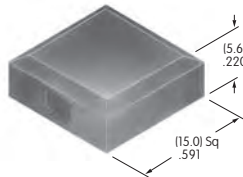

## AT3076

**Flat Cap for Illuminated with Lens/Diffuser**  
 Polycarbonate  
 Colors: JB JC JD JF  
 Series: UB2



## AT3077

**Beveled Cap for Nonilluminated**  
 Polycarbonate  
 Colors: A B C D F  
 Series: UB2

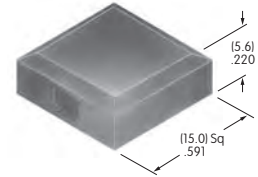

## AT3078

**12mm Sculptured Cap with Lens/Diffuser**  
 Polycarbonate  
 Color: JB  
 Series: KP

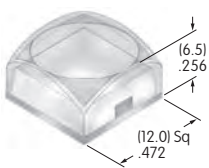

## AT3079

**15mm Sculptured Cap with Lens/Diffuser**  
 Polycarbonate  
 Color: JB  
 Series: KP

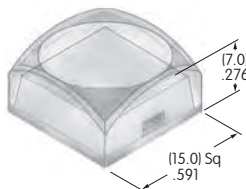

## AT3080

**17.4mm Sculptured Cap with Lens/Diffuser**  
 Polycarbonate  
 Color: JB  
 Series: KP



## AT3081

**Transparent Lens**  
 Polycarbonate  
 Color: J  
 Series: HB2

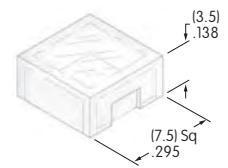

**Color Codes:** A Black B White C Red D Amber E Yellow F Green G Blue H Gray J Clear

# Accessories & Hardware

Toggle

Rockers

Pushbuttons

Illuminated PB

Programmable

Keylocks

Rotaries

Slides

Tactiles

Tilt

Touch

Indicators

Accessories

Supplement

**AT3082**  
**Translucent Diffuser**  
 Polycarbonate  
 Color: B  
 Series: HB2

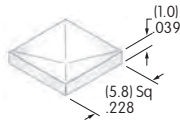

**AT3083**  
**12mm Flat Cap with Lens/Diffuser**  
 Polycarbonate  
 Color: JB  
 Series: KP

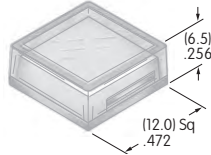

**AT3084**  
**15mm Flat Cap with Lens/Diffuser**  
 Polycarbonate  
 Color: JB  
 Series: KP

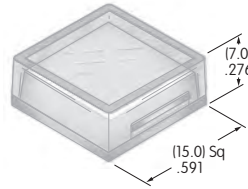

**AT3085**  
**17.4mm Flat Cap with Lens/Diffuser**  
 Polycarbonate  
 Color: JB  
 Series: KP

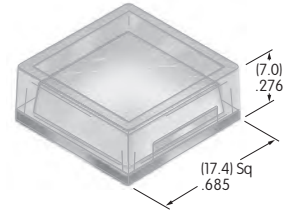

**AT3086**  
**12mm Home Key Cap with Lens/Diffuser**  
 Polycarbonate  
 Color: JB  
 Series: KP

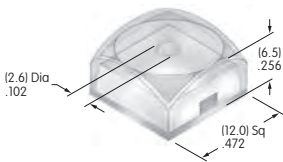

**AT3087**  
**15mm Home Key Cap with Lens/Diffuser**  
 Polycarbonate  
 Color: JB  
 Series: KP

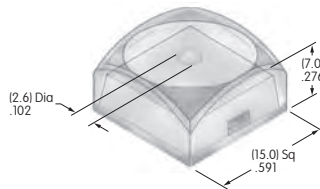

**AT3088**  
**17.4mm Home Key Cap with Lens/Diffuser**  
 Polycarbonate  
 Color: JB  
 Series: KP

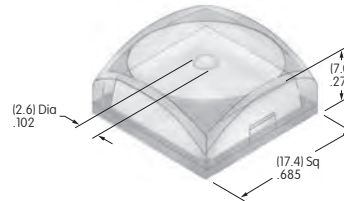

**AT3090**  
**12.0mm Square Sculptured Cap with Alternating Legends**  
 Polycarbonate  
 Color: J  
 Series: KP

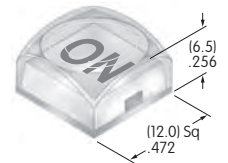

**AT3091**  
**15.0mm Square Sculptured Cap with Alternating Legends**  
 Polycarbonate  
 Color: J  
 Series: KP



**AT3092**  
**17.4mm Square Sculptured Cap with Alternating Legends**  
 Polycarbonate  
 Color: J  
 Series: KP



**AT3093**  
**12.0mm Square Flat Cap with Alternating Legends**  
 Polycarbonate  
 Color: J  
 Series: KP



**AT3094**  
**15.0mm Square Flat Cap with Alternating Legends**  
 Polycarbonate  
 Color: J  
 Series: KP

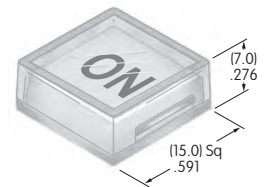

**Color Codes:** A Black B White C Red D Amber E Yellow F Green G Blue H Gray J Clear

# Accessories & Hardware

**AT3095**  
**17.4mm Square Flat Cap with Alternating Legends**  
 Polycarbonate  
 Color: J  
 Series: KP

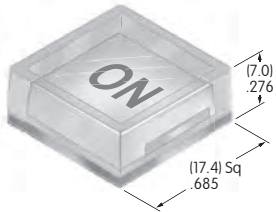

**AT3096**  
**12.0mm Square Home Key Cap with Alternating Legends**  
 Polycarbonate  
 Color: J  
 Series: KP

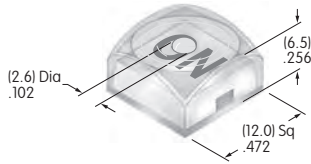

**AT3097**  
**15.0mm Square Home Key Cap with Alternating Legends**  
 Polycarbonate  
 Color: J  
 Series: KP

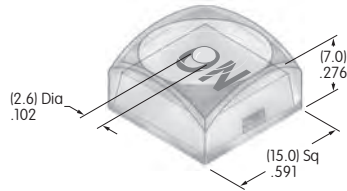

**AT3098**  
**17.4mm Square Home Key Cap with Alternating Legends**  
 Polycarbonate  
 Color: J  
 Series: KP

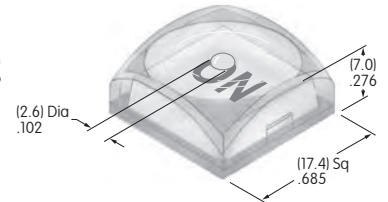

## AT4000s

**AT4001**  
**Square Dust Cover**  
 Lid: Polyvinyl chloride  
 Gasket: Polyethylene  
 Series: LB UB

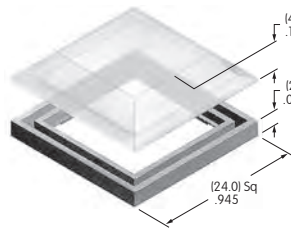

**AT4002**  
**Round Dust Cover**  
 Lid: Polyvinyl chloride  
 Gasket: Polyethylene  
 Series: LB

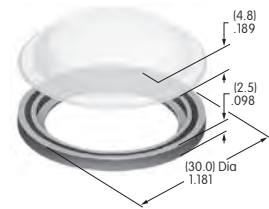

**AT4003**  
**.394" Bat Lever Cap**  
 Polyvinyl chloride  
 Colors: A B C  
 Series: A B

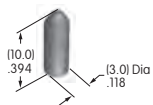

**AT4011**  
**Rectangular Dust Cover**  
 Lid: Polyvinyl chloride  
 Gasket: Polyethylene  
 Series: LB UB

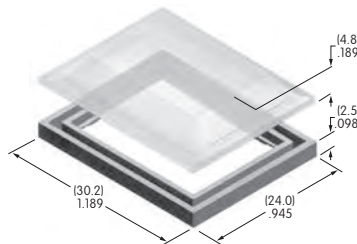

Color Codes: A Black B White C Red D Amber E Yellow F Green G Blue H Gray J Clear

# Accessories & Hardware

Toggle

Rockers

Pushbuttons

Illuminated PB

Programmable

Keylocks

Rotaries

Slides

Tactiles

Tilt

Touch

Indicators

Accessories

Supplement

**AT4012**  
**Round Solid Colored Cap**  
 Polycarbonate  
 Colors: BJ CJ EJ FJ GJ  
 Series: LB

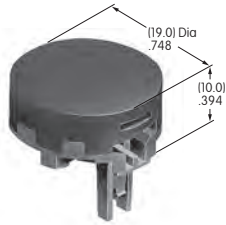

**AT4013**  
**Round Colored Insert Cap**  
 Polycarbonate  
 Colors: JB JC JE JF JG  
 Series: LB



**AT4016**  
**Round Spot Illuminated Cap**  
 Polycarbonate  
 Cap Colors: A B C F  
 LED Colors: C D F CF  
 Series: LB

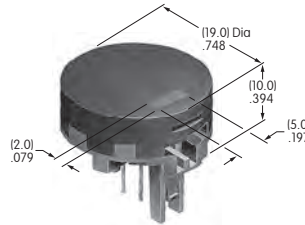

**AT4017**  
**Round Nonilluminated Cap**  
 Polycarbonate  
 Colors: A B C E F G H  
 Series: LB



**AT4021**  
**Rectangular Solid Colored Cap**  
 Polycarbonate  
 Colors: A BB CB CC EB  
 FB FF GB GG  
 Series: KB



**AT4022**  
**Rectangular Colored Insert Cap**  
 Polycarbonate  
 Cap Colors: JB JC JE JF JG  
 Series: KB



**AT4024**  
**Protective Guard**  
 Cover: Polycarbonate  
 Base: Polyamide  
 Series: KB

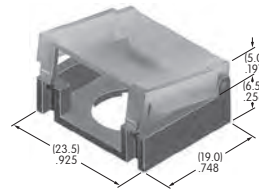

**AT4025**  
**Rectangular Dust Cover**  
 Lid: Polyvinyl chloride  
 Base: Polyamide  
 Series: KB

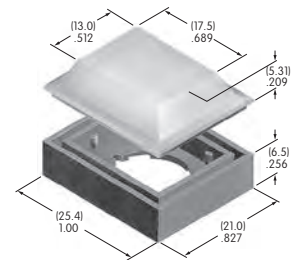

**AT4026**  
**Rectangular Solid Colored Cap**  
 Polycarbonate  
 Colors: BJ CJ EJ FJ GJ  
 Series: LB

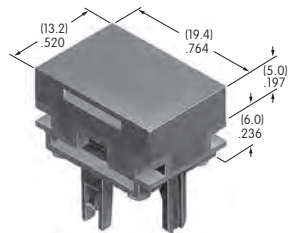

**AT4027**  
**Rectangular Colored Insert Cap**  
 Polycarbonate  
 Colors: JB JC JE JF JG  
 Series: LB

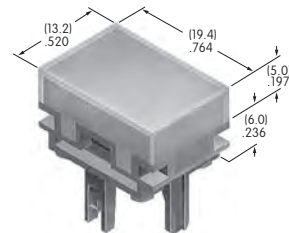

**AT4030**  
**Rectangular Nonilluminated Cap**  
 Polycarbonate  
 Colors: A B C E F G H  
 Series: LB

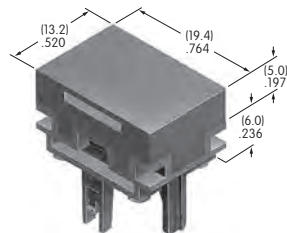

**AT4031**  
**Square Cap for Bright & Super Bright LED**  
 Polycarbonate  
 Colors: JB  
 Series: HB

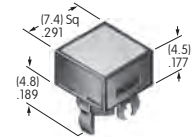

**Color Codes:** A Black B White C Red D Amber E Yellow F Green G Blue H Gray J Clear

# Accessories & Hardware

**AT4032**  
**Round Cap for Bright & Super Bright LED**  
 Polycarbonate  
 Colors: JB  
 Series: HB

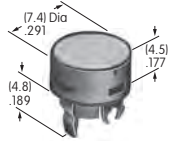

**AT4033**  
**Square Indicator Cap**  
 Polycarbonate  
 Colors: JB  
 Series: HB

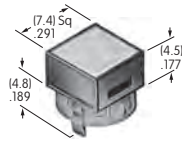

**AT4034**  
**Round Indicator Cap**  
 Polycarbonate  
 Colors: JB  
 Series: HB

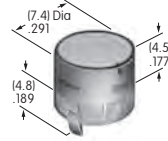

**AT4035**  
**Square Nonilluminated Cap**  
 Polycarbonate  
 Colors: A B C E F G  
 Series: HB

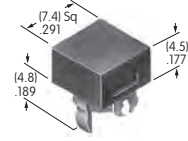

**AT4036**  
**Round Nonilluminated Cap**  
 Polycarbonate  
 Colors: B C E F G  
 Series: HB

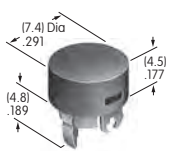

**AT4041 (M-metric H-inch)**  
**Splashproof Boot for Momentary**  
 Black silicone rubber  
 Series: MB

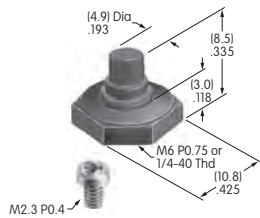

**AT4042 (M-metric H-inch)**  
**Splashproof Boot for Alternate**  
 Black silicone rubber  
 Series: MB

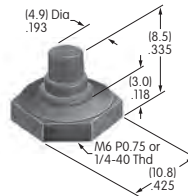

**AT4043**  
**Splashproof Boot**  
 Black silicone rubber  
 Series: MB SB WB

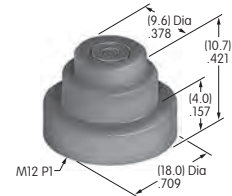

**AT4051**  
**Spot Illuminated Cap**  
 Polycarbonate  
 Colors: AB  
 Series: KB

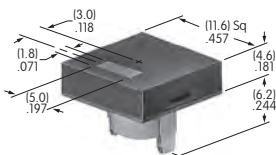

**AT4052**  
**Spot Illuminated Cap**  
 Polycarbonate  
 Colors: AB  
 Series: HB

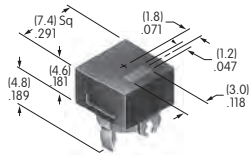

**AT4054**  
**Round Solid Colored Cap**  
 Polycarbonate  
 Colors: BJ CJ EJ FJ GJ  
 Series: LB Panel Seal



**AT4055**  
**Round Colored Insert Cap**  
 Polycarbonate  
 Colors: JB JC JE JF JG  
 Series: LB Panel Seal

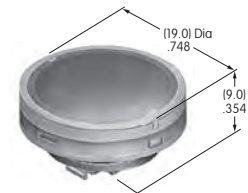

**Color Codes:** A Black B White C Red D Amber E Yellow F Green G Blue H Gray J Clear

# Accessories & Hardware

Toggle

Rockers

Pushbuttons

Illuminated PB

Programmable

Keylocks

Rotaries

Slides

Tactiles

Tilt

Touch

Indicators

Accessories

Supplement

**AT4057**  
Protective Guard  
Polycarbonate  
Series: LB

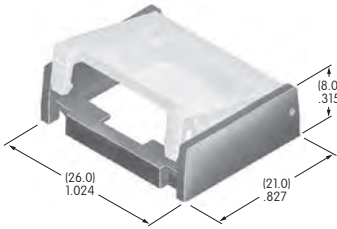

**AT4058**  
Sculptured Cap  
Polyamide  
Colors: A B C E F G H  
Series: JB

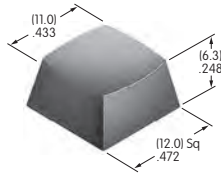

**AT4059**  
Flat Cap  
Polycarbonate  
Colors: A B C E F G H  
Series: JB

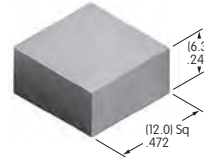

**AT4060**  
Clear Cap with  
Colored Diffuser  
Polycarbonate  
Colors: JB JC JE JF  
Series: JB

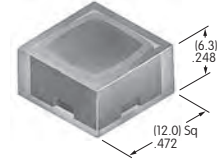

**AT4062**  
Rocker  
Polyamide  
Colors: A B C  
Series: G

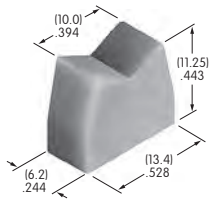

**AT4063**  
.157" Diameter  
Slip-on Cap  
Polyamide  
Colors: A B C  
Series: GB G3B

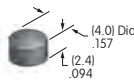

**AT4064**  
.248" Bat Lever Cap  
Polyvinyl chloride  
Polyamide  
Colors: A B C  
Series: A B

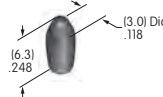

**AT4065**  
Slide Cap  
Polycarbonate  
Cap Color: A  
Window: C E F  
Series: SS

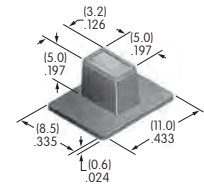

**AT4072**  
Protective Guard  
Lid: Polycarbonate  
Base: Glass fiber  
reinforced polycarbonate  
Series: YB

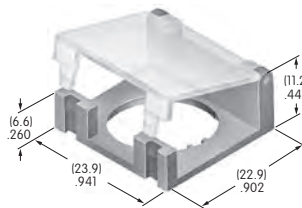

**AT4073**  
Square Opaque Cap  
for Nonilluminated  
Polycarbonate  
Colors: A B C E F G  
Series: UB



**AT4074**  
Square Transparent Cap  
for Illuminated  
Polycarbonate  
Colors: C D F J  
Series: UB



**AT4075**  
Diffuser for  
AT4074 Square Cap  
Polycarbonate  
Colors: B C D F  
Series: UB

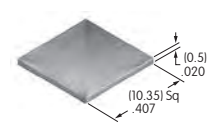

**Color Codes:** A Black B White C Red D Amber E Yellow F Green G Blue H Gray J Clear

# Accessories & Hardware

## AT4076

**Button with Frame for Illuminated**  
 Polycarbonate  
 Colors: BB BC BE BF BH  
 Series: JB

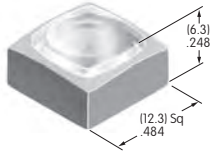

## AT4077

**Button for Nonilluminated**  
 Polycarbonate  
 Colors: B C E F G H  
 Series: JB



## AT4078

**Frame for AT4077**  
 Polycarbonate  
 Colors: B C E F G H  
 Series: JB



## AT4079

**Actuator Key**  
 Brass alloy with bright nickel plating  
 Series: SK

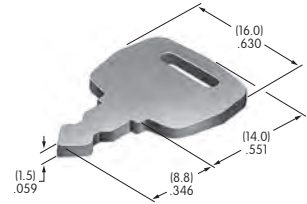

## AT4080

**Actuator Key**  
 Brass alloy with bright nickel plating  
 Antistatic ABS resin handle  
 Color: A  
 Series: SK

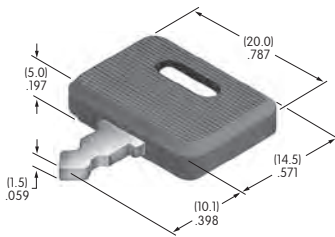

## AT4081

**Actuator Key**  
 Zinc alloy with chrome plating  
 Series: SK

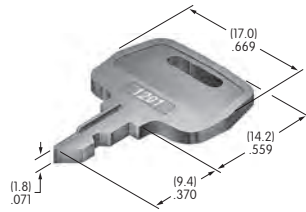

## AT4082

**Actuator Key**  
 Zinc alloy with chrome plating  
 Series: SK



## AT4094

**Actuator Key**  
 Polyacetal  
 Color: A  
 Series: SK

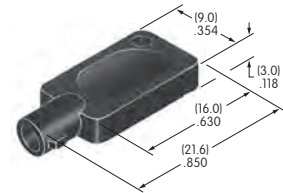

# AT4100s

## AT4103

**Small Color Tipped Knob**  
 Polyester with polyamide tip  
 Base Color: A  
 Tip Colors: A B C E F G H  
 Series: FR01 MR



## AT4104

**Large Color Tipped Knob**  
 Polyester with polyamide tip  
 Base Color: A  
 Tip Colors: A B C E F G H  
 Series: FR01 MR

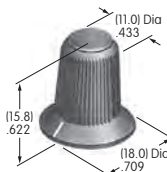

## AT4115

**Dust Cover**  
 Lid: Polyvinyl chloride  
 Base: Polyamide  
 Series: YB

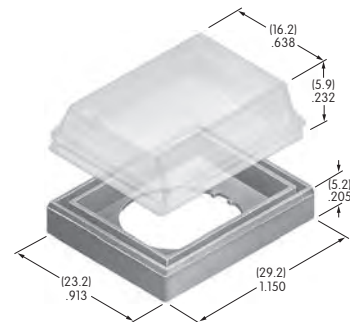

Color Codes: A Black B White C Red D Amber E Yellow F Green G Blue H Gray J Clear

# Accessories & Hardware

Toggles

Rockers

Pushbuttons

Illuminated PB

Programmable

Keylocks

Rotaries

Slides

Tactiles

Tilt

Touch

Indicators

Accessories

Supplement

**AT4116**  
**Rectangular Opaque Cap for Nonilluminated**  
 Polycarbonate  
 Colors: A B C E F G  
 Series: UB

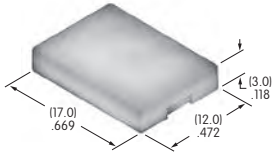

**AT4117**  
**Rectangular Transparent Cap for Illuminated**  
 Polycarbonate  
 Colors: C D F J  
 Series: UB



**AT4118**  
**Diffuser for AT4117 Rectangular Transparent Cap**  
 Polycarbonate  
 Colors: B C D F  
 Series: UB

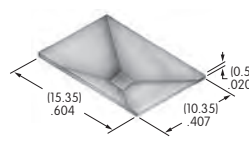

**AT4119**  
**Square Spot Illuminated Cap**  
 Polycarbonate  
 Colors: AB  
 Series: UB

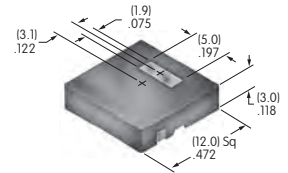

**AT4120**  
**Rectangular Spot Illuminated Cap**  
 Polycarbonate  
 Colors: AB  
 Series: UB

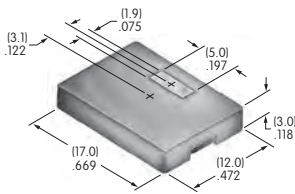

**AT4124**  
**Actuator Key**  
 Brass with nickel plating  
 Series: SK

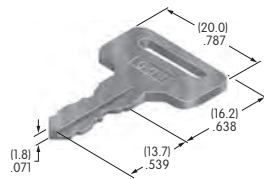

**AT4125**  
**LED Rocker**  
 Polycarbonate  
 Colors: B C E F  
 Series: MLW

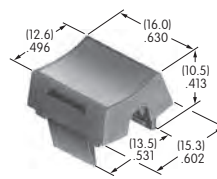

**AT4126**  
**Dust Cover**  
 Polyvinyl chloride & polyamide  
 Color: A  
 Series: JWL

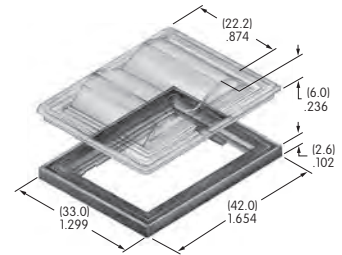

**AT4127**  
**Sculptured Rocker**  
 Polycarbonate  
 Colors: B C E F  
 Series: MLW

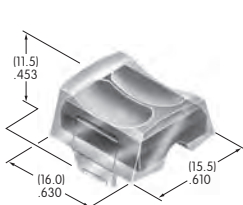

**AT4128**  
**Round Cap for Super Bright LED**  
 Polycarbonate  
 Colors: JB  
 Series: LB

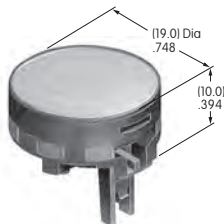

**AT4129**  
**Square Cap for Super Bright LED**  
 Polycarbonate  
 Colors: JB  
 Series: LB

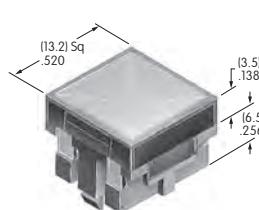

**AT4130**  
**Rectangular Cap for Super Bright LED**  
 Polycarbonate  
 Colors: JB  
 Series: LB

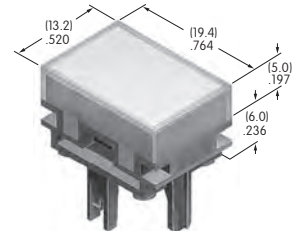

**Color Codes:** A Black B White C Red D Amber E Yellow F Green G Blue H Gray J Clear



# Accessories & Hardware

**AT4131**  
**Round Cap for Super Bright LED**  
 Polycarbonate  
 Colors: JB  
 Series: LB Panel Seal



**AT4132**  
**Round Cap for Bright & Super Bright LED**  
 Polycarbonate  
 Colors: JB  
 Series: KB



**AT4133**  
**Square Cap for Bright & Super Bright LED**  
 Polycarbonate  
 Colors: JB  
 Series: KB



**AT4134**  
**Rectangular Cap for Bright & Super Bright LED**  
 Polycarbonate  
 Colors: JB  
 Series: KB



**AT4135**  
**Frosted Cap with White Base**  
 Polycarbonate  
 Colors: B C E F  
 Series: JB

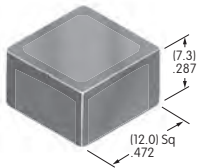

**AT4137**  
**Rectangular Cap**  
 PBT  
 Colors: A B C  
 Series: GB2

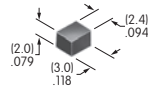

**AT4139**  
**Square Flat Cap**  
 Polycarbonate  
 Colors: A B C H  
 Series: JB

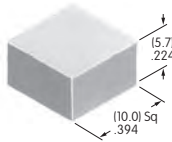

**AT4140**  
**Cap for Mounter AT547**  
 Polycarbonate  
 Colors: A B C H  
 Series: JB

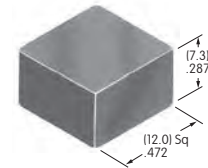

**AT4141**  
**Protective Guard**  
 Cover: Polycarbonate  
 Base: GFR polyamide  
 Series: UB2

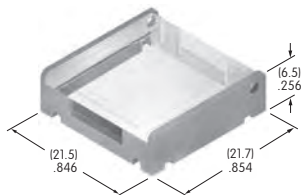

**AT4142**  
**Spring Loaded Protective Guard**  
 Cover: Polycarbonate  
 Base: GFR polyamide  
 Coil spring: Stainless steel  
 Series: UB2

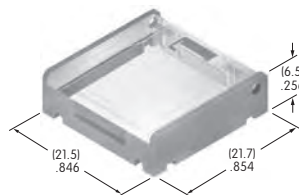

**AT4143**  
**End Barrier**  
 Polyamide  
 Color: A  
 Series: UB2

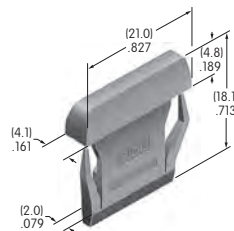

**AT4144**  
**Center Barrier**  
 Polyamide  
 Color: A  
 Series: UB2

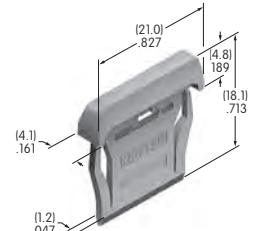

Color Codes: A Black B White C Red D Amber E Yellow F Green G Blue H Gray J Clear

# Accessories & Hardware

Toggle

Rockers

Pushbuttons

Illuminated PB

Programmable

Keylocks

Rotaries

Slides

Tactiles

Tilt

Touch

Indicators

Accessories

Supplement

**AT4145**  
**Square Dust Cover**  
 Lid: PVC  
 Gasket: Polyethylene  
 Series: UB2

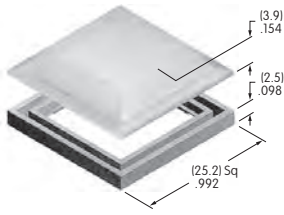

**AT4146**  
**Tubular Key**  
 Brass with nickel plating  
 ABS handle  
 Color: A  
 Series: CKM

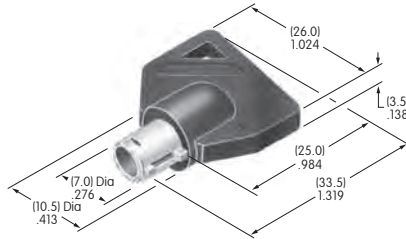

**AT4147**  
**Flat Key**  
 Brass with nickel plating  
 ABS handle  
 Color: A  
 Series: CKM

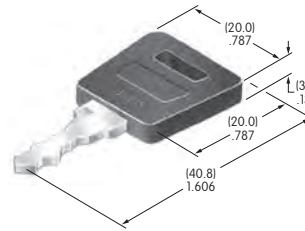

**AT4148**  
**.365" Wide Rocker**  
 Polyamide  
 Colors: A B C E F G H  
 Series: M M2T P

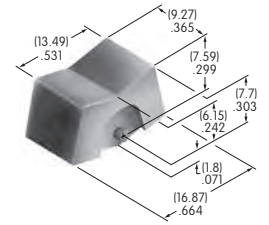

**AT4149**  
**.365" Wide Paddle**  
 Polyamide  
 Colors: A B C E F G H  
 Series: M M2T P

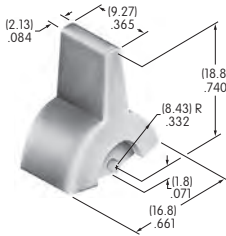

**AT4150**  
**.450" Wide Rocker**  
 Polyamide  
 Colors: A B C E F G H  
 Series: M M2T

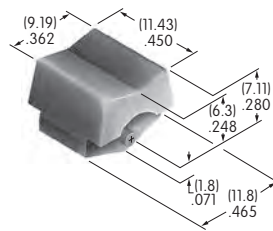

**AT4151**  
**.450" Wide Paddle**  
 Polyamide  
 Colors: A B C E F G H  
 Series: M M2T

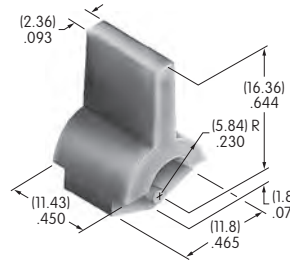

**AT4152**  
**Tubular Key**  
 Brass with nickel plating  
 Series: CKL

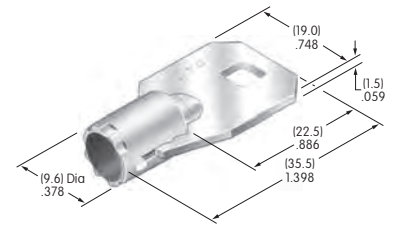

**AT4153**  
**Flat Key**  
 Brass with chrome plating  
 Series: CKL

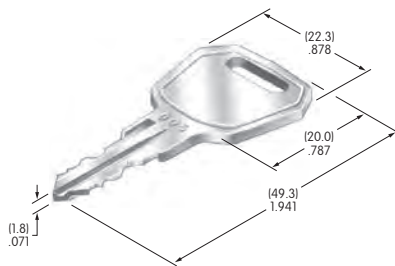

**AT4156**  
**.595" Wide Rocker**  
 Polyamide  
 Colors: A B C E F G H  
 Series: M P

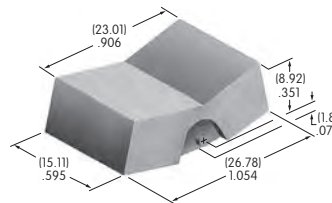

**AT4157**  
**.595" Wide Paddle**  
 Polyamide  
 Colors: A B C E F G H  
 Series: M P

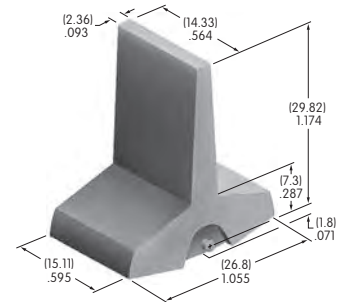

**Color Codes:** A Black B White C Red D Amber E Yellow F Green G Blue H Gray J Clear

# Accessories & Hardware

## AT4158

**Square Cap  
for Bright LED**  
Polycarbonate  
Colors: JC JD JF  
Series: KB



## AT4159

**Rectangular Cap  
for Bright LED**  
Polycarbonate  
Colors: JC JD JF  
Series: KB



## AT4160

**Round Cap  
for Bright LED**  
Polycarbonate  
Colors: JC JD JF  
Series: KB



## AT4162

**Square Cap  
for Bright LED**  
Polycarbonate  
Colors: JB JC JD JF  
Series: LB

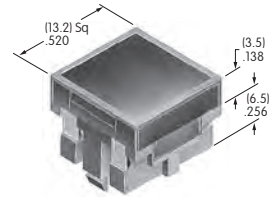

## AT4163

**Rectangular Cap  
for Bright LED**  
Polycarbonate  
Colors: JB JC JD JF  
Series: LB

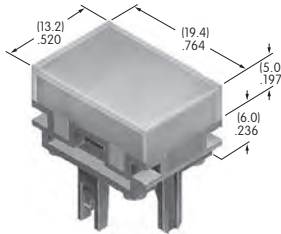

## AT4164

**Round Cap  
for Bright LED**  
Polycarbonate  
Colors: JB JC JD JF  
Series: LB



## AT4165

**Round Cap  
for Bright LED**  
Polycarbonate  
Colors: JB JC JD JF  
Series: LB Panel Seal



## AT4166

**Square Cap  
for Bright LED**  
Polycarbonate  
Colors: CB DB FB  
Series: HB

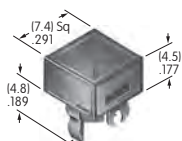

## AT4167

**Round Cap  
for Bright LED**  
Polycarbonate  
Colors: CB DB FB  
Series: HB

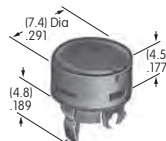

## AT4168

**Square Indicator Cap  
for Bright LED**  
Polycarbonate  
Colors: CB DB FB  
Series: HB

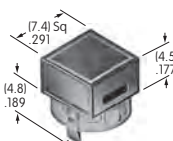

## AT4169

**Round Indicator Cap  
for Bright LED**  
Polycarbonate  
Colors: CB DB FB  
Series: HB



Color Codes: A Black B White C Red D Amber E Yellow F Green G Blue H Gray J Clear

# Accessories & Hardware

Toggle

Rockers

Pushbuttons

Illuminated PB

Programmable

Keylocks

Rotaries

Slides

Tactiles

Tilt

Touch

Indicators

Accessories

Supplement

## AT4170

### Spring Loaded Protective Guard

Cover: Polycarbonate  
Base: Polyamide  
Coil spring: Stainless steel  
Series: KP UB2

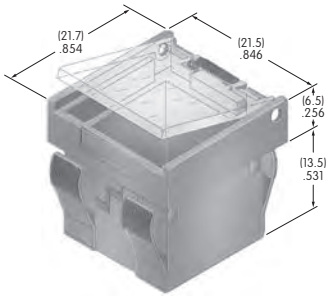

## AT4171

### Spring Loaded Protective Guard

Cover: Polycarbonate  
Base: Polyamide  
Coil spring: Stainless steel  
Series: LB UB

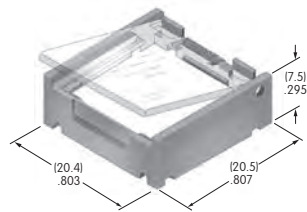

## AT4172

### Spring Loaded Protective Guard

Cover: Polycarbonate  
Base: Polyamide  
Coil spring: Stainless steel  
Series: LB UB

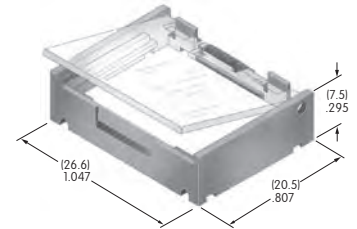

## AT4173

### Spring Loaded Protective Guard

Cover: Polycarbonate  
Base: Polyamide  
Coil spring: Stainless steel  
Series: UB

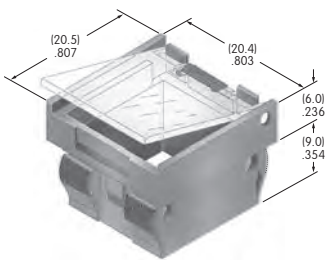

## AT4174

### Spring Loaded Protective Guard

Cover: Polycarbonate  
Base: Polyamide  
Coil spring: Stainless steel  
Series: UB



## AT4175

### Spring Loaded Protective Guard

Cover: Polycarbonate  
Base: Glass fiber reinforced polyamide  
Coil spring: Stainless steel  
Series: YB

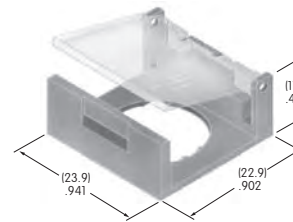

## AT4176

### Square Cap for Bright LED

Polycarbonate  
Colors: JB JC JD JF  
Series: LB

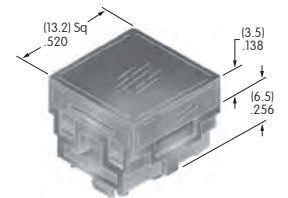

## AT4177

### Rectangular Cap for Bright LED

Polycarbonate  
Colors: JB JC JD JF  
Series: LB

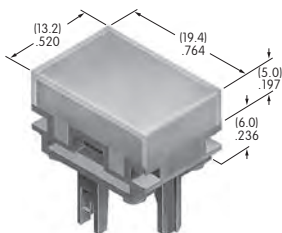

## AT4178

### Round Cap for Bright LED

Polycarbonate  
Colors: JB JC JD JF  
Series: LB



## AT4179

### Round Cap for Bright LED

Polycarbonate  
Colors: JB JC JD JF  
Series: LB Panel Seal



## AT4180

### Snap-on Knob

Polyamide  
Knob: Black  
Flange: Transparent brown  
Series: FR01

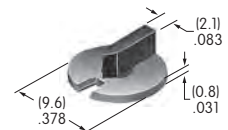

Color Codes: A Black B White C Red D Amber E Yellow F Green G Blue H Gray J Clear

## AT4181

### Splashproof Boot Assembly

Boot Material: Black silicon rubber

Hex Nut Material & Finish: Nickel plated brass

O-ring Material: Nitrile butadiene rubber

Series: M P S WT

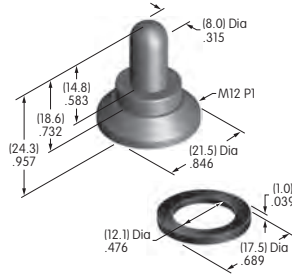

### Switch Installation Instructions

1. Install switch bushing into mounting hole of panel from the back and adjust bushing to protrude 3.5 ~ 5.5mm (.138 ~ .217").
2. Install o-ring on bushing and tighten nut from above.
3. Insert boot onto nut. Be sure the boot and nut are a firm, secure fit.

### Non-Splashproof Switches

M, P or S Toggles with 12mm Bushings

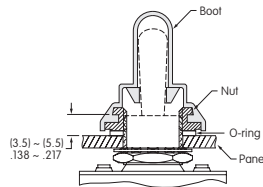

Use boot, nut and o-ring as shown. Use lockwasher and hexagon nut (from standard switch hardware) behind panel.

### Splashproof Switches

S1AW ~ S29AW S Toggles

WT Toggle or M Toggle with B3 Bushing

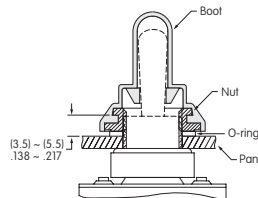

Use boot, nut and o-ring as shown. Use o-ring only (from standard switch hardware) behind panel.

Series or Part Numbers	Panel Thickness (Maximum)
<ul style="list-style-type: none"> <li>• M Series B2 Toggles with 12mm B1 &amp; B3 Bushings</li> <li>• P Series B Toggles with 12mm Bushing</li> <li>• S31 ~ 39, S41 ~ 49, S31F ~ 33F, S41F ~ S43F, S31T ~ 33T, S41T ~ 43T</li> <li>• S301 ~ 309, S331 ~ 339, S301F, S331F ~ 333F, S335F, S301T ~ 309T, S331T ~ 339T</li> <li>• S421 ~ 429, S421T ~ 429</li> </ul>	5.0mm (.197")
<ul style="list-style-type: none"> <li>• WT11S ~ 29S, WT11T ~ 29T, WT11L ~ 29L</li> </ul>	3.5mm (.138")
<ul style="list-style-type: none"> <li>• S1A ~ 7A, S21A, S1F ~ 7F, S21F</li> <li>• S114, S116</li> <li>• S1AW ~ 9AW, S21AW, S25AW ~ 29AW</li> </ul>	3.0mm (.118")

## AT4188

### Diffuser for AT4074

Square Cap

Polycarbonate

Color: B

Series: UB



## AT4189

### Diffuser for AT4117

Rectangular Cap

Polycarbonate

Color: B

Series: UB

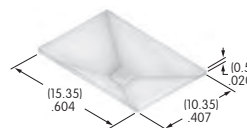

Color Codes: A Black B White C Red D Amber E Yellow F Green G Blue H Gray J Clear

# Accessories & Hardware

Toggles

Rockers

Pushbuttons

Illuminated PB

Programmable

Keylocks

Rotaries

Slides

Tactiles

Tilt

Touch

Indicators

Accessories

Supplement

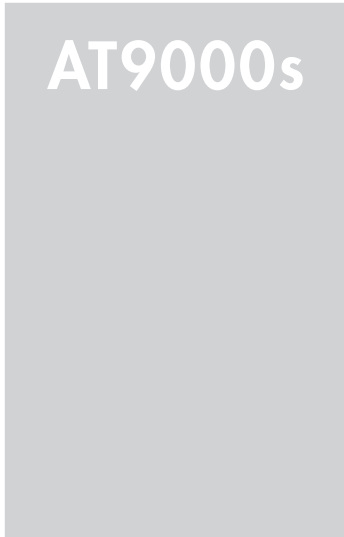

**AT9201**  
**Bezel**  
 Polycarbonate  
 Colors: A B C D E F G H  
 Series: MLW

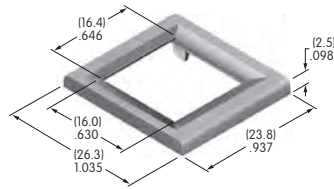

**AT9410**  
**Round Splash Cover**  
 Lid: Polyvinyl chloride  
 Base: Polyethylene  
 O-ring: Nitrile butadiene rubber  
 Series: LB Panel Seal

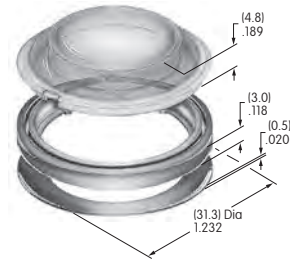

**AT9704-02YC**  
**Socket for LCD 36 x 24**  
**Single & Bicolor Pushbutton**  
 Base: Glass fiber reinforced PBT  
 Terminals: Brass/beryllium copper  
 Series: SmartSwitch

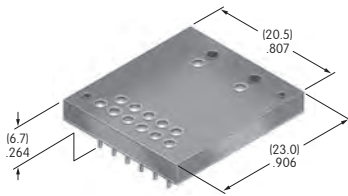

**AT9704-065E**  
**Socket for LCD 36 x 24**  
**RGB Pushbutton**  
 Base: Glass fiber reinforced PBT  
 Terminals: Brass/beryllium copper  
 Series: SmartSwitch

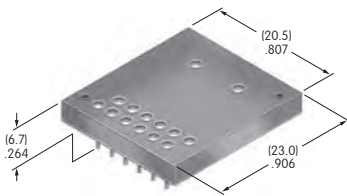

**AT9704-065F**  
**Socket for LCD 36 x 24**  
**Compact Pushbutton**  
 Base: Glass fiber reinforced PBT  
 Terminals: Brass/beryllium copper  
 Series: SmartSwitch

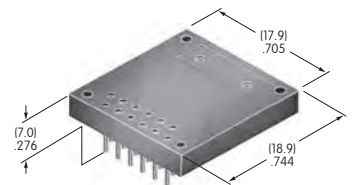

Note: By extracting some of the pins, socket may be used for the **64 x 32 Compact Pushbutton**

**AT9704-085K**  
**Socket for LCD 64 x 32 Pushbutton**  
 Base: Glass fiber reinforced PBT  
 Terminals: Brass/beryllium copper  
 Series: SmartSwitch

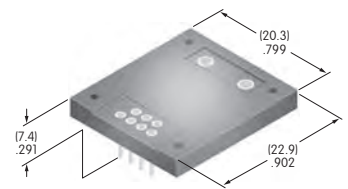

**AT9704-085L**  
**Socket for OLED 64 x 48 Pushbutton**  
 Base: Glass fiber reinforced PBT  
 Terminals: Brass/beryllium copper  
 Series: SmartSwitch

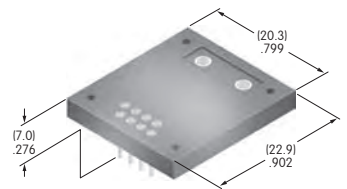

**AT9704-085M**  
**Socket for OLED 52 x 36 Display**  
 Base: Glass fiber reinforced PBT  
 Terminals: Brass/beryllium copper  
 Series: SmartSwitch

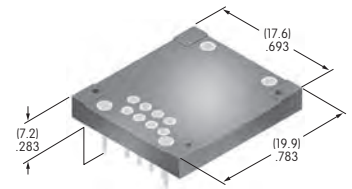

**Color Codes:** A Black B White C Red D Amber E Yellow F Green G Blue H Gray J Clear

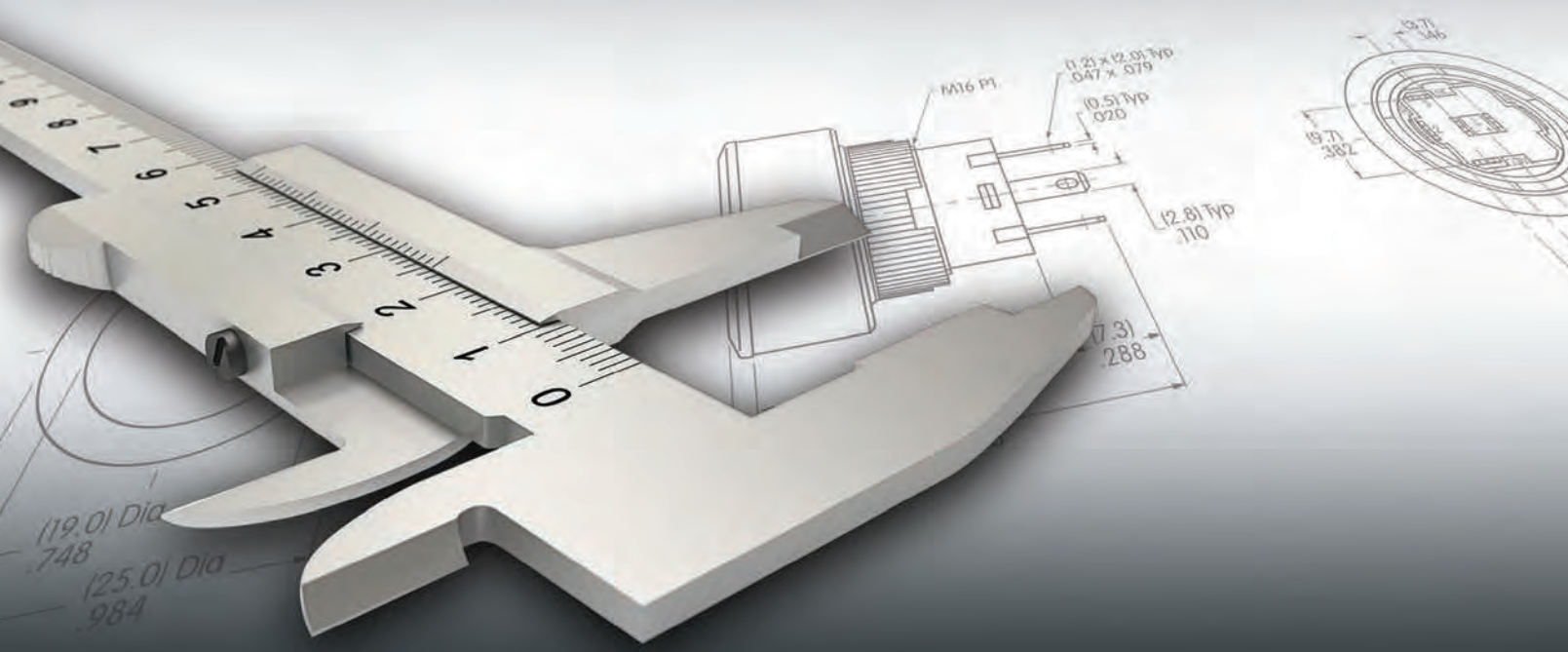

Toggles  
 Rockers  
 Pushbuttons  
 Illuminated PB  
 Programmable  
 Keylocks  
 Rotaries  
 Slides  
 Tactiles  
 Tilt  
 Touch  
 Indicators  
 Accessories  
 Supplement **Z**

	Page
<b>Product Safety Precautions</b>	
Safety Precautions .....	Z3
In-House Standard Test Methods .....	Z4
General Tolerances .....	Z5
<b>Materials &amp; Conversions</b>	
Plastics & Elements .....	Z6
Temperature .....	Z6
Linear Dimensions .....	Z6
Force & Torque .....	Z6
Plating Thickness .....	Z6
Weight .....	Z6
<b>Electrical Ratings</b>	
Rerating Current .....	Z7
Inductive DC Loads; TV Ratings .....	Z8
Operating Range & Dual Ratings .....	Z9
<b>Lamps &amp; LEDs</b>	
Rerating .....	Z10
Application Considerations .....	Z11
Ballast Resistor Calculations & Recommendations .....	Z12
<b>Processing Data</b>	
Processing Recommendation Guide .....	Z14
Process Sealed Switches; Automated Cleaning Specifications .....	Z15
Manual Solder – Profiles A, B .....	Z15
Wave Solder for Through Hole – Profiles A, B .....	Z16
Reflow Solder for SMT – Profiles A, B .....	Z16
<b>Standards &amp; Approvals</b>	
UL Recognition, cULus Recognition, CSA Certification .....	Z17
VDE, ISO, IP .....	Z21
<b>Terms &amp; Acronyms</b>	
Terms & Acronyms .....	Z22
Federal Supply Code .....	Z27
<b>Product Overview</b>	
Ultra-Miniature, Subminiature, Miniature, Specialty, Illuminated, Standard & High Capacity .....	Z28
<b>Index by Model Number</b> .....	Z30



## NKK SWITCHES PRODUCT SAFETY PRECAUTIONS

Read all specifications, instructions and precautions to ensure proper use when selecting and using products. NKK Switches does not accept liability for any problems due to incorrect usage.

Although NKK Switches' products are designed and manufactured in accordance with the highest quality standards, it is nevertheless possible for switch failure to occur as a result of improper or unintended use that could result in performance degradation, short circuits, open circuit failure, and semiconductor failures. To prevent possible injury or property damage, it is recommended to incorporate circuits or devices to protect against the failure of products and the malfunction of equipment design. Confirm that NKK Switches' products are wired and installed properly.

### 1. Voltages and Current

Check the specifications provided for the selected series and do not exceed the parameters for rated voltages and current recommendations.

Certain types of load may lead to large surge currents or reverse voltages. Select switches with the appropriate ratings to suit the type of load. Using an incorrect switch may result in abnormal wear, seizing, or contact failure.

Do not use switches under conditions that exceed their rated voltage or current specifications, as it may result in smoke, fire, or other malfunction. If there is a risk of exceeding rated voltage or current, precautions should be in place, such as appropriate protective circuits.

### 2. Usage Environment

Take account of the particular environment and conditions before selecting products.

Products do not feature sealed construction unless specified as waterproof. Sealed, or waterproof products are intended as panel sealed and cannot be used underwater or submersed in oil. Use in environments where the product may be subject to splashing liquids or dust may result in contact failure.

The use of waterproof caps is recommended where dirt, water, oil, or other substances may accumulate on the moving parts of panel surfaces.

Switches that are rarely operated should be actuated periodically to prevent potential problems, such as lubricants hardening and contact degradation.

Do not use switches in an environment where flammable gases are present. Heat generated by switch operation may lead to ignition or explosion.

Switch durability (service life) may vary significantly, depending on operating conditions. Before use, confirm compatibility of the switch selected for the application under actual usage conditions. Do not exceed the number of recommended operation cycles. Continuing to use switches with degraded performance may result in insulation failure, contact seizing, contact failure, damage, or burnout.

The resin used for products has been specially selected in accordance with the standards of NKK Switches. Do not use where there may be a risk of combustion unless appropriate fire prevention measures have been taken.

### 3. Soldering Temperature

Soldering times and temperatures should not exceed recommended ranges for each specific series.

Do not operate switches during or immediately after soldering (within 1 to 2 minutes), as it may lead to melting of resin components. Do not apply force to the terminals or lead wires.

### 4. External Force

Handle switches with care, as they may become damaged if impacted or dropped, whether loose or in packaging.

Operate switches by applying force in the correct direction.

Do not apply excessive force. Note that subjecting products to undue force may deform the terminals or cause contact failures or malfunctions. Do not subject the operating parts to impact – for example, with use of screwdrivers, wrenches, or other tools.

# Safety Precautions

Toggle

## 5. Storage

**Avoid storing devices in hot or humid locations. Products should be stored at temperatures of about 25°C (15°C – 35°C) and relative humidity of about 55% (25% – 85%).**

Avoid storing in locations where corrosive gases are present. Store products away from exposure to direct sunlight.

Products should be stored in original packaging to prevent sulfurization of terminals. Use products as soon as possible (within one year of delivery).

Avoid placing parts under heavy objects.

Rockers

Pushbuttons

## In-House Standard Test Methods

Ratings and performance figures provided in this catalog are based on NKK's In-House Standard Test Methods. Unless specifically stated otherwise, they are derived from tests performed within the standard atmospheric conditions described below. Note that these do not constitute guarantees for all standard atmospheric condition ranges.

Illuminated PB

### Initial Values

- Ambient temperature: 15°C – 35°C (59°F – 95°F)
- Relative humidity (RH): 25% – 85%
- Atmospheric pressure (kPa): 86 – 106

Programmable

Ratings and performance figures are concluded from individual tests and do not authorize warranties if the switches experience extended continuous operation at either extreme high or extreme low ends of the ranges. Optimal performance falls within the range of environmental tests. Contact factory if more details are needed.

Keylocks

For specifications not described in this catalog or for using NKK Switches' products in special environments, contact the factory.

Rotaries

### Contact Resistance (Initial Values)

At a value determined by the individual specification, voltage declines and resistances are calculated.

The resistance value shall be at the maximum value of the individual specification.

Slides

### Insulation Resistance (Initial Values)

A voltage of the individual specification shall be applied. The resistance value is at the maximum value of the individual specification. Devices shall be tested between terminals and between individual terminals and frame.

Tactiles

### Dielectric Strength (Initial Values)

Voltage of the individual specification shall be applied. There shall be no abnormality such as short-circuit, dielectric breakdown, or leakage of current, etc. Devices shall be tested between terminals and between individual terminals and frame.

Tilt

### Vibration

Testing shall be executed with conditions that include a vibration frequency and amplitude outlined by the individual specification. There shall be no mechanical failure, no looseness of any part, no disassembled parts, with no electrical interruption.

Touch

### Shock

Testing shall be executed with conditions to include a shock wave, shock wave time outlined by the individual specification. There shall be no mechanical failure, no looseness of any part, no disassembled parts, with no electrical interruption.

Indicators

### Corrosion

Testing shall be executed with the conditions outlined by the individual specification. There shall be no impairment or deterioration. Insulation resistance and dielectric strength must meet the requirement defined by the individual specification.

Accessories

### Moisture Proof

Testing shall be executed with conditions including temperature and relative humidity outlined by the individual specification. There shall be no failure of mechanical operation immediately after the test. Insulation resistance and dielectric strength must meet the requirement defined by the individual specification.

Supplement

## Heat Resistance (Operating)

Test parts are kept in a thermostatic oven at a temperature and condition outlined by the individual specification and shall make and break the electrical endurance test up to maximum number of operations. There shall be no failure of operation. Contact resistance, insulation resistance and dielectric strength must meet the requirement defined in the individual specification.

## Heat Resistance (Storage)

Test parts are kept in the thermostatic oven at a temperature determined by the individual specification. There shall be no electrical or mechanical failure. Contact resistance, insulation resistance and dielectric strength must meet the requirement outlined by the individual specification.

## Cold Proof (Operating)

Test parts shall make and break the operational test without load, in the thermostatic oven at a temperature defined by the individual specification. There shall be no electrical or mechanical failure. Contact resistance, insulation resistance and dielectric strength must meet the requirement outlined by the individual specification.

## Cold Proof (Storage)

Test parts are kept in the thermostatic oven at a temperature determined by the individual specification. There shall be no electrical and mechanical failure. Contact resistance, insulation resistance and dielectric strength must meet the requirement outlined by the individual specification.

## Electrical Endurance

Test parts shall make and break the operational test at voltage, current and load determined by the individual specification. There shall be no electrical or mechanical failure. Contact resistance, insulation resistance and dielectric strength must meet the requirement outlined by the individual specification.

## Mechanical Endurance

Test parts shall make and break the operational test at a voltage and current determined by the individual specification without load. There shall be no electrical or mechanical failure. Contact resistance, insulation resistance and dielectric strength must meet the requirement outlined by the individual specification.

## Usage Precautions

The operating temperature (humidity) ranges are guaranteed by evaluations based on the individual series specifications, and do not constitute warranties for extended continuous operation at either extreme high or low ends of the operating temperature range, or for constant operation at that temperature (or humidity).

During actual use, switches may be subjected to circumstances not tested in the laboratory. Before operating, confirm that actual usage will occur within operating environments and load conditions as outlined in recommended criteria.

Operation frequency and speed will affect switch performance. Switches may exhibit contact failure, seize, or sustain damage if operated too infrequently, very slowly or very quickly. Optimum performance may not be achieved for certain operating frequencies or operating speeds. Contact the factory if more details are needed.

## GENERAL TOLERANCES

General Tolerances Unless Otherwise Specified	Range	Dimensions
	Up to 6mm	±0.3
	Over 6mm & up to 30mm	±0.5
	Over 30mm & up to 50mm	±0.8

# Materials & Conversions

Toggles  
 Rockers  
 Pushbuttons  
 Illuminated PB  
 Programmable  
 Keylocks  
 Rotarys  
 Slides  
 Tactiles  
 Tilt  
 Touch  
 Indicators  
 Accessories  
 Supplement Z

## PLASTICS

Specific Name	Acronym or Abbreviation	Generic Name
Acrylonitrile butadiene styrene	ABS	Shatterproof thermoplastic composed of styrene and acrylic resin; ABS provides resilience, shiny appearance, and stable base for metal plating
Carbon blended polyamide		Polyamide blended with carbon for antistatic property
Carbon composite polyacetal		Polyacetal
Diallyl phthalate	DAP	Diallyl phthalate; a thermosetting resin
Ethylene Propylene Terpolymer	EPT	Ozone resistant plastic
Glass fiber reinforced diallyl phthalate	GFR DAP	Diallyl phthalate
Glass fiber reinforced polyamide	GFR PA	Polyamide
Glass fiber reinforced polybutylene terephthalate	GFR PBT	Polyester
Liquid crystal polymer	LCP	Liquid crystal polymer
Nitrile butadiene rubber	NBR	NBR; mainly used where oil-proof is required
Phenolic resin		Phenol plus aldehydes; used extensively as thermosetting plastic
Polyacetal		Polyacetal
Polyamide	PA	Nylon 6/6; Polyamide; always a nylon resin
Polybutylene terephthalate	PBT	Polyester
Polycarbonate	PC	Lexan; Polycarbonate; damaged by trichloroethylene solvent and so changes to polyamide
Polyethylene	PE	Polyethylene
Polyphenylene sulfide	PPS	Polyphenylene sulfide
Polyoxymethylene	POM	Polyoxymethylene
Polypropylene	PP	Polypropylene; more elastic than polycarbonate
Polyvinyl chloride	PVC	Polyvinyl chloride; loses pliability below 0°C (32°F)
Resin		Polymer
Silicone		Silicone

## ELEMENTS

<b>Ag</b>	silver	<b>Cr</b>	chromium	<b>Pb</b>	lead
<b>Al</b>	aluminum	<b>Cu</b>	copper	<b>Sn</b>	tin
<b>Au</b>	gold	<b>Ni</b>	nickel	<b>Zn</b>	zinc

## TEMPERATURE

Fahrenheit	(Fahrenheit - 32) x .555 = Celsius	°C	°F	°C	°F
Thermometric scale with fixed points marked 32°F for freezing point and 212°F for boiling of water.		-40	-40	0	+32
		-30	-22	+50	+122
		-25	-13	+55	+131
		-20	-4	+70	+158
		-10	+14	+85	+185
				+100	+212

## LINEAR DIMENSIONS

Formulas for Conversion	Fraction	Inch	Millimeter	Fraction	Inch	Millimeter
millimeter x .03937 = inch		.100	2.54		.394	10.0
		.150	3.81	15/32	.469	11.9
		.197	5.0		.472	12.0
inch x 25.4 = millimeter		.236	6.0	1/2	.500	12.7
	1/4	.250	6.35			

## FORCE

### Formulas for Conversions

ounce•force	x	.2780139	=	newton
pound-force	x	4.4482220	=	newton
kilogram-force	x	9.8066500	=	newton
newton	x	.1019716	=	kilogram-force
newton	x	.2248089	=	pound-force
newton	x	3.5969420	=	ounce•force

## TORQUE

### Formulas for Conversions

kg/cm	x	2.2046	x	.3937	=	lb/in
newton•meter	x	.7375621	=	pound-foot		
newton•meter	x	.1019716	=	kilogram-meter		
newton•meter	x	141.6119	=	ounce-inch		
newton•meter	x	8.8507	=	pound-inch		
pound-foot	x	1.355818	=	newton•meter		

## PLATING THICKNESS

<b>Micron</b>	1 micron = 1 thousandth of 1 millimeter
One millionth of a meter; a micrometer	1 micron ÷ .0254 = 39.37 millionths of an inch
	Example: 3 microns ÷ .0254 = 118.11 millionths of an inch

## WEIGHT

1 gram = .03527 ounce	1 ounce = 31.10348 grams
1 kilogram = 35.27 ounces	1 ounce = .03110348 kilogram
1 kilogram = 2.2 pounds	1 pound = .4539 kilogram

## RERATING CURRENT FOR SWITCHES WITH 125V AC RATINGS

Generally, most switch applications can be classified into one of the below load categories. Switch capacities can be mathematically rerated when the application calls for a category or voltage other than the switch standard general specification ratings, meaning original current ratings at 125V AC. NKK has not conducted life tests at these rerated voltages and currents so it is important to contact the factory in such cases. The candidate switch should be tested in the actual application in which it is intended to function.

### Factors for Calculating Rerated Current at Various Loads

New Voltage Rating	Resistive Load Multiply by:	Inductive Load Multiply by:	Lamp Load Multiply by:	Motor Load Multiply by:	Capacitive Load Multiply by:
125VAC	1	0.50 ~ 0.66 (PF 0.6)	0.20 ~ 0.25	0.33	0.25
250VAC	0.50 ~ 0.66	0.25 ~ 0.33 (PF 0.6)	0.10 ~ 0.16	0.16 ~ 0.22	0.12 ~ 0.16
12VDC	1	0.75 ~ 1	0.20 ~ 0.25	0.33	0.25
30VDC	0.50 ~ 1	0.25 ~ 0.50	0.10 ~ 0.25	0.16 ~ 0.33	0.12 ~ 0.25
48VDC	0.25 ~ 0.33	0.20 ~ 0.25	0.05 ~ 0.08	0.08 ~ 0.11	0.06 ~ 0.08
125VDC	0.05	0.02 ~ 0.03	N/A	N/A	N/A

#### Sample Calculation for Model M2012SS1W01

with 6A @ 125VAC resistive rating.  
To use at 48V DC inductive, multiply  
 $6A \times 0.25 = 1.5A @ 48VDC$

#### Sample Calculation for Model JWL22RCA

with 16A @ 125/250VAC resistive rating.  
To use at 30V DC motor load, multiply  
 $16A \times 0.33 = 5.28A @ 30VDC$

### Resistive Load

Resistive loads can be purely resistive or of the tungsten-heater load type. A resistive load that has no heating element is the easiest for a switch to handle, and the switch's rating is based on this type of load. A resistive load is one in which 100% of the load is composed of resistive devices. The power factor is high (PF = 1) and contact erosion is low. Consequently, the switch's electrical life can be anticipated with some certainty.

### Lamp Load

When a switch closes on a resistive lamp load, the switch sees a short circuit because the cold resistance of the lamp filament is near zero. The surge current as the switch closes can be many times the steady state current. As the lamp filament heats up to operating temperature, the resistance of the filament increases and the current decreases to the lamp's steady state.

### Motor

Motor loads present yet another brutal environment for switch contacts. Closing the switch contact on a motor start-up load causes very large current surges of about 3 to 8 times the running current. When the switch is opened and the current decreases, the magnetic field of the inductor collapses and an electromotive force is induced. The polarity of the induced voltage is such as to oppose any change in current flow. This induced voltage aids the source voltage in striking an arc and maintaining it as the contacts separate.

### Inductive Load

Non-motor inductive loads, such as those seen in switching power supplies, have inrush currents that greatly exceed the normal operating currents of the equipment. This inrush current can easily reach 8 to 10 times the steady state current. As a switch on an inductive load is opened, the inductor, or transformer,

induces a counter option "voltage" in the circuit. This voltage opposes any change in the circuit current and can reach hundreds of volts. This extremely high voltage can restrike the arc as the switch contacts open resulting in severely eroded or welded contacts.

### Capacitive

With such loads as DC power supplies, welding machines, and strobe charging units the inrush current is even more damaging than with inductive loads. To the switch a capacitive load appears as a dead short as the switch closes. In the first few milliseconds the inrush current can sometimes reach 100 times the steady state current of the circuit. Even worse for the switch, this inrush occurs before the contact bounce has subsided. This produces severe arcing and massive contact erosion. Often the contacts weld upon closure preventing the switch from ever opening. In an emergency the operator of the equipment would know he could not open the circuit.

# Electrical Ratings

Toggles

Rockers

Pushbuttons

Illuminated PB

Programmable

Keylocks

Rotaries

Slides

Tactiles

Tilt

Touch

Indicators

Accessories

Supplement

## INDUCTIVE LOADS

In AC circuits the voltage and current are varying in a sinusoidal pattern; both the voltage and current cross the zero reference 120 times per second for 60Hz. Therefore, the chances of closing or opening a switch when the voltage and current are at their maximum in AC circuits is remote.

In DC circuits the voltage and current do not vary and are always at their rated levels. Compared to AC

circuits with the same voltage and current, DC circuits handle 1.414 times the power. Therefore, when opening or closing a switch on a DC load, the arc developed is more severe, more energetic, and lasts longer causing more contact erosion and a shorter switch life. A switch intended for a DC circuit should have its AC capacity rerated for DC. See previous page for rerating current.

## DESIGN FOR INDUCTIVE DC LOAD MODELS S800D & SW3800D

Bar magnets are placed at each end of high capacity switches, and their magnetic field opposes the field created by the arcing current, thereby extinguishing the arc and protecting the contacts.

Positive (+) must be connected to end terminals and negative (-) to common terminals.

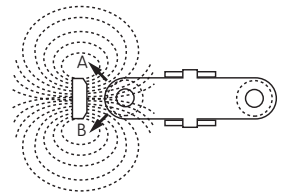
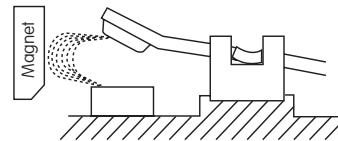
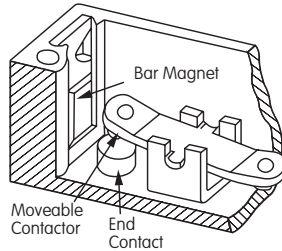

## TV RATINGS

The TV5 and TV8 ratings are tested and assigned by the Underwriters Laboratory. The switches are intended to be used as "Power ON" devices in equipment where a high tungsten inrush current is anticipated, such as tungsten-filament lamp loads or entertainment equipment like sound systems and monitors.

An example is the TV8 test which consists of an overload test and an endurance test. The overload test consists of a switch closing on a minimum inrush current of 163 amps with 50 consecutive operations at a rate of 10 cycles per minute. The test must be conducted without any failures. In the endurance test the current is reduced to 117 amps, and the same switch is subjected to another 25,000 operations.

The JWL is a product example that has been tested and meets the TV8 rating.

In addition to the electrical testing, the switch enclosure (housing) must comply with the requirements for classifying materials as UL94V-0. The insulation material must have arc-tracking characteristics with a minimum arcing time of 180 seconds when tested in accordance with the Standard

Test Methods for High-Voltage, Low-Current Arc Resistance of Solid Electrical Insulation.

The JWM and JWL switches are rugged, dependable, and well suited to high inrush circuits.

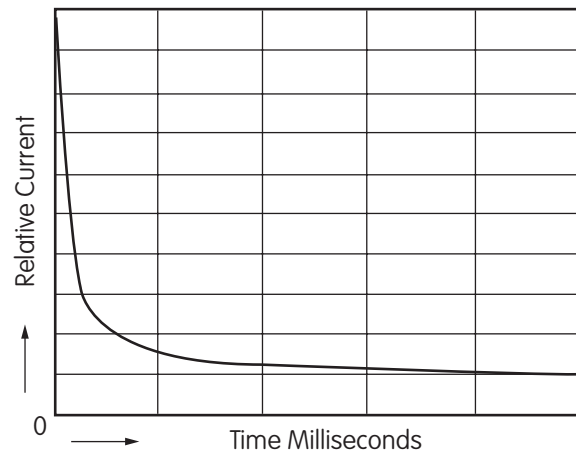

Typical Tungsten Inrush Curve

## OPERATING RANGE

Three contact materials are commonly used in NKK switches: gold, silver, and gold over silver. These materials give the options of low level, power level, plus combined power and low level ratings.

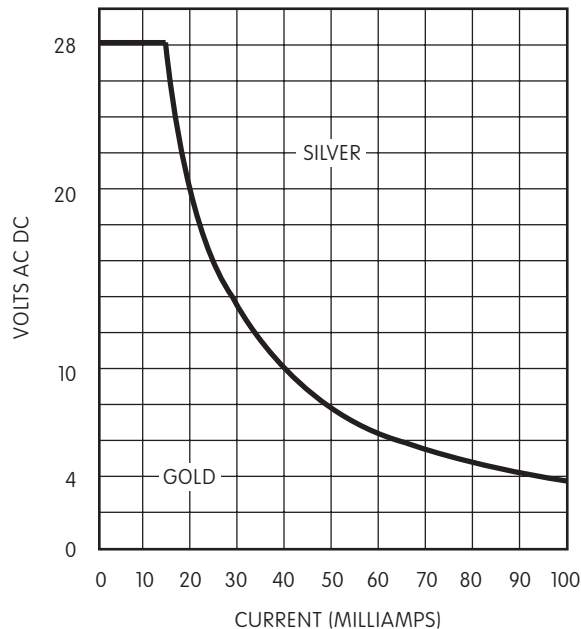

### Low Level ~ 0.4VA maximum @ 28V AC or DC maximum

Gold plated contacts are recommended for dry circuits, which are defined as very low energy. In circuits where the voltage is below 28 volts DC and current is below 100 milliamps (dry circuits), no arc develops as the contacts open or close. So, the tarnish remains. Eventually without the arc, the contacts become so encrusted that the switch is unable to close the circuit due to the high contact resistance.

The solution to this is plating the contacts with gold, which does not tarnish, thus assuring the full electrical life of the switch.

### Power Level ~ 100mA to 10 amps @ 125V AC

Silver contacts are recommended for electrical levels above 0.4VA. Although silver tarnishes, it is a good conductor and this electrical energy is sufficient to break through the tarnish to give reliable performance. The oxidation which coats the contact surfaces with a hard layer of insulative contamination is removed by arcing. In circuits where the voltage is above about 12 volts DC and the current above .5 amps, an arc develops during opening or closing of the contacts. This arc keeps the oxidation cleaned off.

### Power or Low Level

Gold over silver contacts are used in applications requiring both dry and power circuits. NKK's gold over silver contacts have dual ratings as further described below.

## DUAL RATINGS

The dual rated option is suitable where identical switches are used in both a logic and a power level circuit within the same application.

Dual rated switches enable the user to install the same switch in both a logic level (dry circuit) and a power level circuit. However, once a code "A" rated contact switch has been used at a power level, it cannot then be used at a logic level.

There may be advantages to stocking only a single switch for use in both a logic level and a power level circuit. Our dual rated contact material option allows this

advantage. However, once a dual rated contact material switch has been used at a power level it cannot then be used at a logic level.

The gold over silver contact material provides a reliable, tarnish free, contact surface for logic level switching. When this same contact material switch is used in power level circuit, the gold plating is removed by contact arcing. If an attempt is then made to use this same switch in a logic level circuit (where no arcing occurs). The low current condition cannot provide adequate contact wiping or cleaning.

# Lamps & LEDs

## RERATING

When a lamp is to be operated at a voltage other than the rated or design voltage, the rerated lamp specifications should be calculated to determine suitability for the user's application. The following formulas assist in predicting the rerated effect on luminous intensity, endurance and current. Results are most reliable for applied voltages close to the rated voltage.

$$\text{Rerated MSCP} = \text{Rated MSCP} \times \left[ \frac{\text{Applied Voltage}}{\text{Rated Voltage}} \right]$$

$$\text{Rerated Life} = \text{Rated Life} \times \left[ \frac{\text{Rated Voltage}}{\text{Applied Voltage}} \right]$$

$$\text{Rerated Current} = \text{Rated Current} \times \left[ \frac{\text{Applied Voltage}}{\text{Rated Voltage}} \right]$$

For your convenience, the graph below illustrates the way current, candlepower, and life performance vary with percent changes in applied voltage. The graphed values are typical for miniature and subminiature lamps with the average life based on rated voltages at 60 cycles AC, in room temperature, and under static conditions.

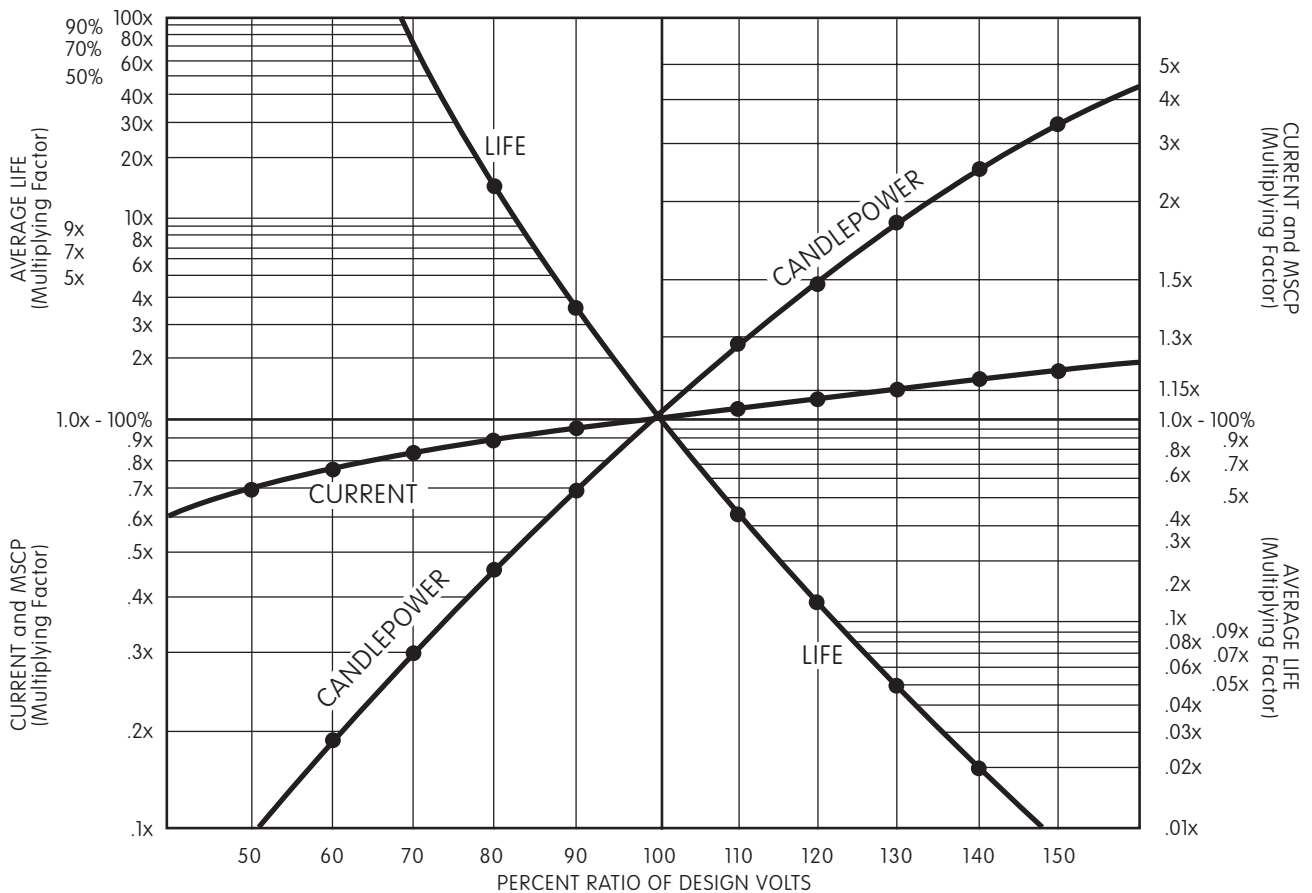

Source: General Instrument Chicago Miniature Brand Incandescent and Neon Lamps, Catalog No. 8400-Rev 1, (Chicago, Illinois: General Instrument Corporation), page 3.

Toggles

Rockers

Pushbuttons

Illuminated PB

Programmable

Keylocks

Rotaries

Slides

Tactiles

Tilt

Touch

Indicators

Accessories

Supplement Z



## APPLICATION CONSIDERATIONS

### LEDs

Light emitting diodes (LEDs) operate at relatively low current and DC voltage levels and have comparatively unlimited service life. Their characteristics do not change significantly with age, and they are not easily damaged by shock or vibration. A variety of NKK's switches and indicators are offered with red,

green, yellow, amber, blue, white, or bicolor (red/green) LEDs.

Most of the LEDs used in our products require a ballast resistor connected in series with the LED. In addition, we offer 5-, 12-, and 24-volt lamps with internal resistors in the YB series.

### Incandescent Lamps

Lamp life is determined in a laboratory environment where conditions are near perfect. Actual applications, unlike the test environment, involve many factors which can greatly affect the values listed in lamp specifications. Of all the operating characteristics, lamp life is the least predictable. The lamp filament must deteriorate to produce illumination, and actual life is a function of this unpredictable rate of deterioration. Thus, exact life performance cannot be

determined for any incandescent lamp under any set of conditions.

Lamps perform at their maximum when used at their rated AC voltages or below. There are many known conditions or factors that affect lamp life. Using the lamp in abusive environments such as high ambient temperatures, high shock and/or vibration, constant illumination, and DC voltage accelerates deterioration of the tungsten filament.

### Neon Lamps

Neon lamps are low-current, long-life sources limited by the high ionization voltage of neon ( $\geq 80$  volts) for use in line voltage circuits. A series resistor is required in all neon lamps for current limiting. Larger lamps often include an integral resistor sized for a specific voltage.

Neon lamps glow with a low intensity, amber light. Bright light and vivid colors are not obtainable

with neon lamps. Their typical 1.5mA current drain, better than 25,000-hour service life, and good resistance to shock and vibration make them an excellent alternative in many line voltage applications. For best visibility they should be used with clear lenses and diffusers. Other suitable colors are red, orange, yellow, or white.

### LED & Lamp Part Numbers for Each Series

PN	Type	Series	PN	Type	Series	PN	Type	Series
AT070	LED	EB M MB24	AT618	LED	EB M MB24	AT630	LED	HB
AT602	Incand.	LW MLW	AT621	LED	YB	AT631	LED	KB LB YB YB2
AT602N	Neon	LW MLW	AT622	LED	MLW	AT632	LED	KB LB YB YB2
AT607	Incand.	LB	AT624	LED	HB	AT633	LED	HB
AT607N	Neon	LB	AT625	LED	KB LB YB YB2	AT634	LED	KB YB YB2
AT611	Incand.	KB YB	AT627	LED	LB	AT635	LED	KB LB
AT615	Neon	KB	AT628	LED	YB YB2	AT636	LED	KB YB YB2
AT617	LED	EB M MB24	AT629	LED	HB			

# Ballast Resistors

## BALLAST RESISTOR CALCULATIONS & RECOMMENDATIONS

If the source voltage is greater than the rated voltage of a lamp or LED, a ballast resistor must be connected in series with the lamp. The following circuit diagram and formula will assist in calculating the value of the required ballast resistor.

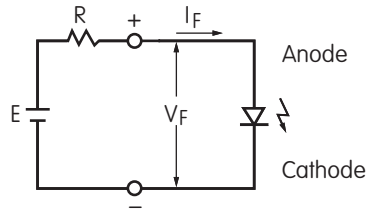

$$R = \frac{E - V_F}{I_F}$$

Where: R = Resistor Value (Ohms)  
E = Source Voltage (V)  
V<sub>F</sub> = Forward Voltage (V)  
I<sub>F</sub> = Forward Current (A)

Watt recommendations provide a margin to reduce heat rise and increase life.

FORWARD VOLTAGE		SOURCE VOLTAGE E																			
V <sub>F</sub>	I <sub>F</sub>	5V		6V		9V		12V		14V		16V		18V		22V		24V		28V	
V	mA	Ω	W	Ω	W	Ω	W	Ω	W	Ω	W	Ω	W	Ω	W	Ω	W	Ω	W	Ω	W
1.65	25	130	1/4	180	1/2	300	1/2	430	1	510	1	560	1	680	2	820	2	910	2	1.1K	2
1.70	30	110	1/2	150	1/2	240	1	360	1	430	1	470	2	560	2	680	2	750	2	910	3
1.75	40	82	1/2	110	1/2	180	1	270	1	300	2	360	2	430	2	510	3	560	3	680	3
1.77	20	160	1/4	220	1/4	360	1/2	510	1/2	620	3/4	750	3/4	820	1	1.0K	1	1.1K	1	1.3K	1.5
1.80	48	68	1/2	91	1/2	150	1	220	2	240	2	300	2	330	2	430	3	470	3	560	3
1.85	20	160	1/4	220	1/4	360	1/2	510	1	620	1	750	1	820	1	1.0K	1	1.2K	2	1.5K	2
1.90	8	390	1/8	510	1/8	910	1/4	1.2K	1/4	1.5K	1/4	1.8K	1/4	2.0K	1/2	2.4K	1/2	2.7K	1/2	3.3K	1/2
	15	220	1/8	270	1/4	470	1/2	680	1/2	820	1/2	1.0K	1	1.1K	1	1.5K	1	1.5K	1	1.8K	2
	16	200	1/4	220	1/4	430	1/2	620	1/2	750	1	910	1	1.0K	1	1.2K	1	1.3K	1	1.6K	1
	20	150	1/4	200	1/4	360	1/2	510	1/2	620	3/4	750	1	820	1	1.0K	1	1.1K	1	1.3K	2
1.95	26	120	1/4	160	1/2	300	1/2	390	1	470	1	560	1	620	1	820	2	910	2	1.1K	2
	15	220	1/8	270	1/4	470	1/2	680	1/2	820	1/2	1.0K	1	1.1K	1	1.5K	1	1.5K	1	1.8K	2
	20	150	1/4	200	1/4	360	1/2	510	1/2	620	3/4	680	3/4	820	1	1.0K	1	1.1K	1	1.3K	2
1.96	24	130	1/4	160	1/2	300	1/2	430	1	510	1	560	1	680	2	820	2	910	2	1.1K	2
	16	200	1/4	240	1/4	430	1/2	620	1/2	750	1/2	910	1	1.0K	1	1.3K	1	1.3K	1	1.6K	1
	15	200	1/8	270	1/4	470	1/2	680	1/2	820	1	910	1	1.1K	1	1.3K	1	1.5K	1	1.8K	1
2.00	20	150	1/4	200	1/4	360	1/2	510	1	620	1	750	1	820	1	1.0K	1	1.1K	2	1.3K	2
	24	120	1/4	160	1/2	300	1/2	430	1	510	1	560	1	680	2	820	2	910	2	1.1K	2
	25	120	1/4	160	1/2	270	1/2	390	1	470	1	560	1	620	2	820	2	910	2	1.1K	2
	26	120	1/4	160	1/2	270	1/2	390	1	470	1	560	1	620	1	820	2	910	2	1.0K	2
	48	62	1/2	82	1/2	150	1	200	1	240	1	300	2	330	2	430	3	470	3	560	3
2.07	16	180	1/8	240	1/4	430	1/2	620	1/2	750	1/2	910	3/4	1.0K	3/4	1.3K	1	1.3K	1	1.6K	1
2.10	15	200	1/8	270	1/4	470	1/2	680	1/2	820	1/2	1K	1	1.1K	1	1.3K	1	1.5K	1	1.8K	1
	20	150	1/4	200	1/4	360	1/2	510	1	620	1	680	1	820	1	1.0K	1	1.1K	1	1.3K	1
	24	120	1/4	160	1/2	300	1/2	430	1	510	1	560	1	680	2	820	2	910	2	1.1K	2
	25	120	1/4	160	1/2	270	1/2	390	1	470	1	560	1	620	2	820	2	910	2	1.1K	2
	30	100	1/4	130	1/2	240	1	330	1	390	1	470	2	510	2	680	2	750	2	910	2
	40	75	1/2	100	1/2	180	1	270	1.5	300	1.5	360	1.5	430	2	510	2	560	3	680	3
2.15	45	68	1/2	91	1/2	160	1	220	2	270	2	330	2	360	2	430	3	510	3	620	3
	16	180	1/8	240	1/4	430	1/2	620	1/2	750	1/2	910	3/4	1.1K	3/4	1.2K	1	1.3K	1	1.6K	1
2.16	20	150	1/4	200	1/4	360	1/2	510	1	620	1	680	1	820	1	1.0K	1	1.1K	1	1.3K	1
	16	180	1/8	240	1/4	430	1/2	620	1/2	750	1/2	910	3/4	1.0K	3/4	1.2K	1	1.3K	1	1.6K	1

## BALLAST RESISTOR CALCULATIONS & RECOMMENDATIONS

If the source voltage is greater than the rated voltage of a lamp or LED, a ballast resistor must be connected in series with the lamp. The following circuit diagram and formula will assist in calculating the value of the required ballast resistor.

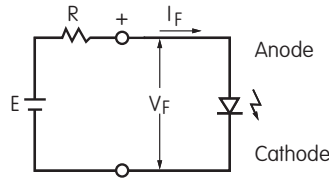

$$R = \frac{E - V_F}{I_F}$$

Where: R = Resistor Value (Ohms)  
 E = Source Voltage (V)  
 V<sub>F</sub> = Forward Voltage (V)  
 I<sub>F</sub> = Forward Current (A)

Watt recommendations provide a margin to reduce heat rise and increase life.

FORWARD		SOURCE VOLTAGE																			
VOLTAGE	CURRENT	E																			
V <sub>F</sub>	I <sub>F</sub>	5V		6V		9V		12V		14V		16V		18V		22V		24V		28V	
V	mA	Ω	W	Ω	W	Ω	W	Ω	W	Ω	W	Ω	W	Ω	W	Ω	W	Ω	W	Ω	W
2.20	20	150	1/4	200	1/4	360	1/2	510	1	620	1	750	1	820	1	1.0K	1	1.1K	2	1.3K	2
	26	110	1/4	160	1/2	270	1/2	390	1	470	1	560	1	620	1	820	2	910	2	1.0K	2
	30	91	1/2	130	1/2	220	1	330	1	390	1	470	2	510	2	680	2	750	2	820	3
2.25	20	150	1/4	200	1/4	360	1/2	510	1	620	1	750	1	820	1	1.0K	1	1.1K	2	1.3K	2
2.27	20	150	1/4	200	1/4	330	1/2	510	1/2	620	3/4	750	3/4	820	1	1.0K	1	1.0K	1	1.2K	1
2.30	20	130	1/4	180	1/4	330	1/2	510	1/2	620	3/4	680	3/4	820	1	1.0K	1	1.0K	1	1.2K	1
2.35	40	68	1/4	91	1/2	160	1	240	1	300	2	330	2	390	2	510	3	560	3	620	3
2.80	20	110	1/4	160	1/4	330	1/2	470	1/2	560	1	680	1	750	1	1.0K	1	1.1K	1	1.3K	1
3.20	20	91	1/8	150	1/4	300	1/2	470	1/2	560	1/2	680	3/4	750	3/4	1.0K	1	1.0K	1	1.2K	1
3.30	20	91	1/8	150	1/4	300	1/2	430	1/2	560	1/2	680	3/4	750	3/4	1.0K	1	1.0K	1	1.2K	1
3.40	20	82	1/8	130	1/4	300	1/2	430	1/2	560	1/2	680	3/4	750	3/4	1.0K	1	1.0K	1	1.2K	1
3.50	20	75	1/4	120	1/8	270	1/4	430	1/2	560	1	620	1	750	1	1.0K	1	1.1K	2	1.3K	2
3.60	20	68	1/4	120	1/8	270	1/4	430	1/2	560	1	620	1	750	1	1.0K	1	1.1K	2	1.3K	2
	30	47	1/8	82	1/4	180	1/2	270	1	360	1	430	1	470	2	620	2	680	2	820	2
3.80	26	47	1/8	91	1/4	200	1/2	300	1/2	390	1	470	1	560	1	750	1.5	820	1.5	1.0K	2
	30	39	1/8	75	1/4	180	1/2	270	1	330	1	430	1	470	2	620	2	680	2	820	2
3.90	30	36	1/8	68	1/4	180	1/2	270	1	330	1	390	1	470	2	620	2	680	2	820	2
4.00	26	39	1/8	82	1/4	200	1/2	330	1/2	390	1	470	1	560	1	750	1.5	820	1.5	1.0K	2
	30	33	1/8	68	1/4	130	1/2	270	1	330	1	390	1	470	2	620	2	680	2	820	2
4.20	20	39	1/8	91	1/8	240	1/4	390	1/2	510	1	620	1	680	1	910	1	1.0K	1	1.2K	1
	30	27	1/8	62	1/4	160	1/2	270	1	330	1	390	1	470	2	620	2	680	2	820	2
4.30	20	36	1/8	82	1/8	240	1/4	390	1/2	470	1/2	560	1	680	1	910	1	1.0K	1	1.2K	1
4.40	26	24	1/8	62	1/4	180	1/2	300	1/2	390	1	470	1	560	1	680	1.5	750	1.5	910	1.5
5.00	25	—	—	47	1/8	160	1/2	300	1	360	1	470	1.5	560	1.5	680	2	820	2	1.0k	2.5
5.50	12.5	—	—	82	1/8	330	1/2	160	1	560	1/4	910	1/2	1.1K	1	1.5K	1	1.6K	1	1.8K	1
	25	—	—	43	1/8	160	1/4	300	1/2	360	1/2	470	1	560	1	680	1	820	1.5	1.0K	1.5
	45	—	—	24	1/8	91	1/2	160	1	200	1	270	1.5	300	1.5	390	2	430	3	560	3
	52	—	—	20	1/8	82	1/2	150	1	180	1.5	220	1.5	270	3	330	3	390	3	470	3
12.00	12.5	—	—	—	—	—	—	—	—	160	1/8	330	1/8	510	1/4	820	1/2	1K	1/2	1.3K	1
	15	—	—	—	—	—	—	—	—	150	1/8	270	1/8	400	1/4	680	1/2	820	1/2	1.5K	1
	20	—	—	—	—	—	—	—	—	100	1/8	200	1/4	300	1/2	510	1	620	1	820	1
	26	—	—	—	—	—	—	—	—	82	1/8	160	1/4	240	1	390	1	470	1	620	1
24.00	10	—	—	—	—	—	—	—	—	—	—	—	—	—	—	—	—	—	—	400	1/8
	13	—	—	—	—	—	—	—	—	—	—	—	—	—	—	—	—	—	—	330	1/2

# Processing Data

## PROCESSING RECOMMENDATION GUIDE

Series & Type	PCB		SMT		Cleaning	
	Wave Solder	Manual Solder	IR Reflow	Vapor Phase	Auto-matic	Manual
A Rockers	x	x			x	
A Toggles	x	x			x	
AB Pushbuttons	x	x			x	
AS Slides	x	x				x
B Illuminated Toggles	x	x			x	
B Toggles	x	x			x	
BB Pushbuttons	x	x			x	
CB Tactiles	x	x			x	
CB3 SMT Tactiles		x	x		x	
CS Slides	x	x				x
D2 Toggles	x					x
DB Pushbuttons	x	x				x
DSA Tilt	x	x				x
DSB Tilt	x	x			x	
EB Pushbuttons (PCB)	x	x				x
FR01 DIP Rotaries	x	x				x
FR02 SMT DIP Rotaries		x	x			x
FS Slides	x	x				x
G Illuminated Toggles	x	x			x	
G Rockers	x	x			x	
G Toggles	x	x			x	
G3B SMT Pushbuttons		x	x		x	
G3T SMT Toggles		x	x		x	
GB Illuminated Plunger	x	x			x	
GB Pushbuttons	x	x			x	
GB2 Pushbuttons	x	x				x
GW Illum. Paddles	x	x				x
GW Rockers/Paddles	x	x				x
HB2 Illum. Pushbuttons	x	x				x
HPO2 Tactiles	x	x				x
HPO3 SMT Tactiles		x	x			x
IS LCD PB & Display	x	x				x
IS OLED PB & Display	x	x				x
JB Illuminated Tactiles	x	x			x	

Series & Type	PCB		SMT		Cleaning	
	Wave Solder	Manual Solder	IR Reflow	Vapor Phase	Auto-matic	Manual
JB Tactiles	x	x			x	
JF Illuminated Tactiles	x	x			x	
JF Tactiles	x	x			x	
JL Illuminated Tactiles	x	x				x
JS DIP Slides	x	x				x
JS SMT DIP Slides		x	x			x
KP Illum. Pushbuttons	x	x				x
M Rockers (PCB)	x	x				x
M Toggles (PCB)	x	x				x
M2B Pushbuttons	x	x			x	
M2T Rockers	x	x			x	
M2T Toggles	x	x			x	
M2100 Illum Act's (PCB)	x	x				x
MB2000 PBs (PCB)	x	x				x
MB2400 PBs (PCB)	x	x				x
MB2500 PBs (PCB)	x	x				x
MRA Rotaries	x	x			x	
MRB Rotaries	x	x			x	
MRF Rotaries	x	x			x	
MRK Rotaries	x	x			x	
MS Illuminated Slides	x	x				x
MS Slides	x	x				x
ND Rotaries	x	x			x	
ND3 SMT Rotaries		x	x		x	
NPO1 Pushbuttons	x	x				x
P Rockers (PCB)	x	x				x
P Toggles (PCB)	x	x				x
SK Keylocks (PCB)	x	x			x	
SM Slides	x	x				x
SS Illuminated Slides	x	x				x
SS Slides	x	x				x
SS3 SMT Slides		x	x			x
UB Pushbuttons (PCB)	x	x				x
UB2 Pushbuttons (PCB)	x	x				x

## PROCESS SEALED SWITCHES

NKK, a pioneer in the development of process sealed switches, is ahead of its time as a manufacturer. These process sealed switches are increasingly in demand because of the advancements in automated PC board processing. NKK's expansive family of process compatible devices includes toggles, rockers, pushbuttons, tactiles, rotaries, keylocks and slides in a variety of sizes.

Over 50 years of quality design experience produced the first process sealed switches to satisfy the process requirements of PC

board soldering and cleaning techniques. As the cutaway drawings on our Distinctive Characteristics pages illustrate, our process sealed switches incorporate all the features necessary to accomplish their process compatibility: epoxy sealed terminals, heat resistant resins, interior rubber o-rings, seals, and sleeves, plus ultrasonic welding. The following data has been developed from a comprehensive study of test data, technical literature, and industry practice.

### Automated Cleaning Specifications

#### Temperature Stabilization

To minimize the thermal shock, switches should be allowed to cool to 38°C or to the temperature of the hand or machine cleaning.

#### Flux

NKK Switches recommends a no-clean (low residue) flux that can be either left on the board or cleaned with a mild organic solvent. A second choice is a synthetic flux that can be effectively removed with an alcohol-based solvent. A water soluble flux is not recommended because of the corrosive nature of the flux residue. The relatively high temperature and energetic cleaning methods needed to ensure complete removal of all flux residues could also be hazardous to the switch.

#### Flux Removal

Cleaning should take place at a slightly elevated room temperature between 38°C and 52°C. Spray pressure should not exceed 25psi. See table of Flux Removal Conditions below to determine recommended depth of submersion, time and temperature.

#### Drying

Drying time should be extended to a one-hour bake at 52°C maximum. This step will eliminate any condensation.

#### Flux Removal Conditions

Series	Depth (mm)	Time (Minutes)	Temperature (°C)
A, B	100	5	—
AB, BB, G, GB, SK-B	50	5	—
CB, CB3, JB, JF, M2B, M2T	50	1	50
G3B, G3T, ND, ND3	100	1	70
MRA, MRB, MRF	50	3	—
SK-E	50	1	60

### Manual Solder Profiles

Manual Solder Profile	Profile A High Temperature	Profile B Low Temperature
Solder Iron Tip Temperature	390°C	350°C
Time on Terminal	4 seconds	3 seconds
Cycles	2	1

#### Notes:

Profiles A and B are for lead-free.  
Do not exceed these specifications.

# Processing Data

Toggles

Rockers

Pushbuttons

Illuminated PB

Programmable

Keylocks

Rotaries

Slides

Tactiles

Tilt

Touch

Indicators

Accessories

Supplement Z

## Wave Solder Profiles for Through Hole

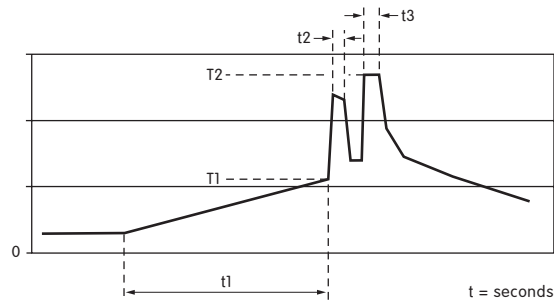

Wave Solder Profile	Symbol	Profile A High Temperature	Profile B Low Temperature
Preheat Temperature	T1	110°C	110°C
Preheat Time	t1	40 seconds	30 seconds
Peak Temperature	T2	270°C	270°C
Peak Time	t2 + t3	6 seconds	5 seconds
Thickness of PCB		1.6mm	1.6mm
Cycles		2	2
Comments		PCB with no Lead	PCB with no Lead

## Reflow Solder Profiles for SMT

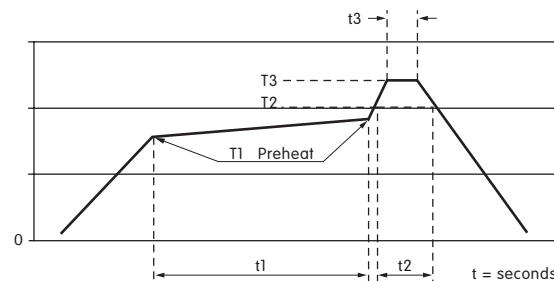

Reflow Solder Profile	Symbol	Profile A High Temperature	Profile B Low Temperature
Preheat Temperature	T1	180°C ~ 200°C	150°C ~ 170°C
Preheat Time	t1	120 seconds	90 seconds
Heating Temperature	T2	230°C	200°C
Heating Time	t2	60 seconds	30 seconds
Peak Temperature (Surface)	T3	250°C	240°C
Peak Time	t3	Not Specified	Not Specified
Thickness of PCB		1.6mm	1.6mm
Cycles		2	2
Comments		PCB with no Lead	PCB with no Lead

### Notes:

The Reflow Solder profile above describes the printed circuit board (PCB) surface temperature. Since the PCB surface temperature and the switch surface temperature will vary depending on the height of the switch, the PCB material, and PCB thickness, ensure that the

switch surface temperature does not exceed 250°C for high temperature (column A), or 240°C for low temperature (column B). Contact the factory if your conditions are more severe than the above specifications.

# Standards & Approvals

**Underwriters Laboratories Inc.**



Find certifications at [www.ul.com](http://www.ul.com)  
 File No. E44145  
 Class Description:  
 Switches, Special Use – Component.  
 Switches are supplied without marking unless specified. See General Specifications page of each series for ordering instructions.

**Underwriters Laboratories Inc.**



Find certifications at [www.ul.com](http://www.ul.com)  
 File No. E44145  
 Class Description:  
 Switches, Special Use – Certified for Canada. Switches are supplied without marking unless specified. See General Specifications page of each series for ordering instructions.

**Canadian Standards Association**



Online at [www.csa-international.org](http://www.csa-international.org)  
 File No. 023535\_0\_000  
 Class No. 6241-10; Class Description:  
 C22.2 No. 55: Switches-Snap-Special Use.  
 Switches are supplied without marking unless specified. See General Specifications page of each series for ordering instructions.

**UL, cULus recognized & CSA certified only when ordered with marking on the switch.**

**See details regarding specific options in each switch section.**

Basic NKK Part No.	Rating Amps@Volts	UL	cULus	CSA	Basic NKK Part No.	Rating Amps@Volts	UL	cULus	CSA
CWSA	6A @ 250V AC	•	•		KB15	1A @ 125/250V AC	•	•	•
CWSB	6A @ 250V AC	•	•		KB16	1A @ 30V DC	•	•	•
CWSB (illum.)	9A @ 125V AC	•		•	KB25	0.4VA @ 28V DC	•	•	•
CWSC (illum.)	9A @ 125V AC	•		•	KB26		•	•	•
CWT12	6A @ 250V AC	•	•		LB15		•	•	•
	6A @ 125V AC	•			LB16	3A @ 125/250V AC	•	•	•
	3A @ 250V AC	•			LB25	0.4VA @ 28V DC	•	•	•
EB2011		•	•	•	LB26		•	•	•
EB2065	3A @ 125V AC	•	•	•	LP0125	3A @ 125V AC	•	•	
EB2061	3A @ 125V AC	•	•	•		3A @ 250V AC	•	•	
EB2085		•	•	•		3A @ 30V DC	•	•	
FB15ANEP2	0.5A @ 125V AC	•	•		LW3122		•	•	
HB15		•	•		LW3123		•	•	
HB16	0.1A @ 30V AC/DC	•	•		LW3125	10A @ 125V AC	•	•	
HS16-1		•	•		LW3128	6A @ 250V AC	•	•	
HS16-2		•	•		LW3129		•	•	
HS16-3	12A @ 125V AC	•	•		<b>Toggle</b>		•	•	•
HS16-4	6A @ 250V AC	•	•		M2011		•	•	•
HS16-5		•	•		M2012		•	•	•
HS16-6		•	•		M2013		•	•	•
JPL	TV8, 125V AC	•	•		M2015		•	•	•
JPM	TV5, 125V AC	•	•		M2018		•	•	•
JWL11		•	•	•	M2019		•	•	•
JWL12	TV8,	•	•	•	M2021	6A @ 125V AC	•	•	•
JWL21	16A @ 250V AC	•	•	•	M2022	3A @ 250V AC	•	•	•
JWL22	5A @ 72V DC (UL)	•	•	•	M2023	0.4VA @ 28V DC	•	•	•
JWM11		•	•	•	M2024		•	•	•
JWM12	TV5,	•	•	•	M2025		•	•	•
JWM21	10A @ 250V AC	•	•	•	M2026		•	•	•
JWM22	10A @ 30V DC	•	•	•	M2027		•	•	•
JWLW11		•			M2028		•	•	•
JWLW12		•			M2029		•	•	•
JWLW21	16A @ 250V AC	•			M2032		•	•	•
JWLW22		•			M2033		•	•	•
JWMW11		•		•	M2035		•	•	•
JWMW12	10A @ 250V AC	•		•	M2038	6A @ 125V AC	•	•	•
JWMW21	10A @ 30V DC	•		•	M2039	3A @ 250V AC	•	•	•
JWMW22		•		•	M2042	0.4VA @ 28V DC	•	•	•
JWS11	6A @ 125/250V AC	•	•	•	M2043		•	•	•
JWS21	(illum. & nonilluminated)	•	•	•	M2044		•	•	•
					M2045		•	•	•
					M2046		•	•	•
					M2047	6A @ 125V AC	•	•	•
					M2048	3A @ 250V AC	•	•	•
					M2049	0.4VA @ 28V DC	•	•	•

Toggle

Rockers

Pushbuttons

Illuminated PB

Programmable

Keylocks

Rotaries

Slides

Tactiles

Tilt

Touch

Indicators

Accessories

**Z** Supplement

# Standards & Approvals

See details regarding specific options in each switch section.

Basic NKK Part No.	Rating Amps@Volts	UL	cULus	CSA	Basic NKK Part No.	Rating Amps@Volts	UL	cULus	CSA
Rockers M2011	6A @ 125V AC 3A @ 250V AC 0.4VA @ 28V DC	•	•	•	M2T22 M2T23 M2T25 M2T28 M2T29	6A @ 125V AC 3A @ 250V AC 4A @ 30V DC	• • • • •	• • • • •	• • • • •
M2012 M2013 M2015 M2018 M2019	6A @ 125V AC 3A @ 250V AC 0.4VA @ 28V DC	• • • • •	• • • • •	• • • • •	M2T22 M2T23 M2T25 M2T28 M2T29	0.4VA @ 28V DC	• • • • •	• • • • •	• • • • •
M2021	6A @ 125V AC 3A @ 250V AC 0.4VA @ 28V DC	•	•	•	MB2011 MB2065 MB2061 MB2085 MB2181 MB2185	6A @ 125V AC 3A @ 250V AC 0.4VA @ 28V DC	• • • • • •	• • • • • •	• • • • • •
M2022 M2023 M2024 M2025 M2026 M2027 M2028 M2029	6A @ 125V AC 3A @ 250V AC 0.4VA @ 28V DC	• • • • • • • •	• • • • • • • •	• • • • • • • •	MB2411 MB2461	3A @ 125V AC 0.4VA @ 28V DC	• •	• •	• •
M2032 M2033 M2035 M2038 M2039	6A @ 125V AC 3A @ 250V AC 0.4VA @ 28V DC	• • • • •	• • • • •	• • • • •	MB2511 MB2521	3A @ 125V AC 0.4VA @ 28V DC	• •	• •	• •
M2042 M2043 M2045 M2048 M2049	6A @ 125V AC 3A @ 250V AC 0.4VA @ 28V DC	• • • • •	• • • • •	• • • • •	MLW3012 MLW3013 MLW3015 MLW3018 MLW3019	5A @ 125V AC 3A @ 250V AC	• • • • •	• • • • •	• • • • •
M2044 M2046 M2047	6A @ 125V AC 3A @ 250V AC 0.4VA @ 28V DC	• • •	• • •	• • •	MLW3022 MLW3023 MLW3025 MLW3028 MLW3029 MLW3020	5A @ 125V AC 3A @ 250V AC	• • • • • •	• • • • • •	• • • • • •
M2112 M2113	6A @ 125V AC	• •	• •	• •	MRT22 MRT23	10A @ 125V AC 5A @ 125V AC	• •	• •	• •
UL & cULus for M2112 & M2113: Only Synchronous Toggles & Rockers with Solder Lug or Straight PC					MS12 MS13 MS22 MS23	6A @ 125V AC 3A @ 250V AC (nonilluminated)	• • • •	• • • •	• • • •
M2112 M2113	6A @ 125V AC			• •	MS12 MS13 MS20 MS22 MS23	6A @ 125V AC 3A @ 250V AC 0.4VA @ 28V DC (nonilluminated)			• • • • •
CSA for M2112 & M2113: Only Synchronous Toggles & Rockers					P2011 P2012 P2013 P2021 P2022 P2023	10A @ 125V AC 6A @ 250V AC	• • • • • •	• • • • • •	• • • • • •
M2B15 M2B25	1A @ 125V AC 1A @ 30V DC 0.4VA @ 28V DC	• •	• •	• •	S1A S2A S3A	10A @ 125V AC 5A @ 250V AC	• • •	• • •	• • •
M2T12 M2T13 M2T15 M2T18 M2T19	6A @ 125V AC 3A @ 250V AC 4A @ 30V DC	• • • • •	• • • • •	• • • • •	S1A S2A S3A	15A @ 125V AC 6A @ 250V AC			• • •
M2T12 M2T13 M2T15 M2T18 M2T19	0.4VA @ 28V DC	• • • • •	• • • • •	• • • • •					• • • • •

Toggles

Rockers

Pushbuttons

Illuminated PB

Programmable

Keylocks

Rotaries

Slides

Tactiles

Tilt

Touch

Indicators

Accessories

Supplement

Z



# Standards & Approvals

See details regarding specific options in each switch section.

Basic NKK Part No.	Rating Amps@Volts	UL	cULus	CSA	Basic NKK Part No.	Rating Amps@Volts	UL	cULus	CSA
S6A S6AL	20A @ 125V AC 10A @ 250V AC	• •	• •	• •	S301 S302 S303	15A @ 125V AC 6A @ 250V AC	• • •	• • •	• • •
S7A	20A @ 125V AC 10A @ 250V AC			•	S301F	15A @ 125V AC 6A @ 250V AC	•	•	•
S31 S31F	18A @ 125V AC 9A @ 250V AC	• •	• •		S301T S302T S303T	15A @ 125V AC 6A @ 250V AC	• • •	• • •	• • •
S31 S31F	25A @ 125V AC 9A @ 250V AC			• •	S305 S305T S308 S308T S309 S309T	15A @ 125V AC 6A @ 250V AC		• • • •	• • • •
S32 S32F	18A @ 125V AC 9A @ 250V AC	• •	• •		S331	25A @ 125V AC 9A @ 250V AC	•	•	•
S32 S32F	25A @ 125V AC 9A @ 250V AC			• •	S331F	25A @ 125V AC 25A @ 250V AC	•	•	
S33 S33F	18A @ 125V AC 9A @ 250V AC	• •	• •		S331R	25A @ 125V AC 9A @ 250V AC	•	•	
S33 S33F	25A @ 125V AC 9A @ 250V AC			• •	S331T	15A @ 125V AC 15A @ 250V AC	•	•	
S31T S32T S33T	15A @ 125V AC 6A @ 250V AC	• • •	• • •	• • •	S332	25A @ 125V AC 9A @ 250V AC			•
S35 S38 S39	15A @ 125V AC 6A @ 250V AC	• • •	• • •	• • •	S332 S332F S332R	25A @ 125V AC 15A @ 250V AC	• • •	• • •	
S41 S41F S41R	18A @ 125V AC 9A @ 250V AC	• • •	• • •		S332T	15A @ 125V AC 15A @ 250V AC	•	•	
S41 S42 S43	25A @ 125V AC 9A @ 250V AC			• • •	S333	25A @ 125V AC 9A @ 250V AC			•
S41T S42T S43T	15A @ 125V AC 6A @ 250V AC	• • •	• • •	• • •	S333 S333F S333R	25A @ 125V AC 15A @ 250V AC	• • •	• • •	
S42 S42F S42R	18A @ 125V AC 9A @ 250V AC	• • •	• • •		S333T	15A @ 125V AC 15A @ 250V AC	•	•	
S42	25A @ 125V AC 9A @ 250V AC			•	S335	15A @ 125V AC 6A @ 250V AC	•	•	•
S43 S43F S43R	18A @ 125V AC 9A @ 250V AC	• • •	• • •		S335F	25A @ 125V AC 15A @ 250V AC	•	•	
S43	25A @ 125V AC 9A @ 250V AC			•	S335T	15A @ 125V AC 6A @ 250V AC	•	•	
S45 S48 S48R S49 S49R	15A @ 125V AC 6A @ 250V AC	• • • •	• • • •		S338 S338R S338T	15A @ 125V AC 6A @ 250V AC	• • •	• • •	
S114 S116	5A @ 125V AC 2A @ 250V AC			• •	S339 S339R S339T	15A @ 125V AC 6A @ 250V AC	• • •	• • •	

Toggle

Rockers

Pushbuttons

Illuminated PB

Programmable

Key locks

Rotaries

Slides

Tactiles

Tilt

Touch

Indicators

Accessories

Z  
Supplement

# Standards & Approvals

See details regarding specific options in each switch section.

Basic NKK Part No.	Rating Amps@Volts	UL	cULus	CSA	Basic NKK Part No.	Rating Amps@Volts	UL	cULus	CSA
S821 S822 S823	30A @ 125V AC 30A @ 250V AC	• • •	• • •	• • •	SW3001A SW3002A SW3003A	15A @ 125V AC 6A @ 250V AC 1.5A @ 30V DC 10A @ 125V AC (Inductive)	• • •		
S821D S822D S823D	30A @ 30V DC 1.5A @ 125V DC	• • •	• • •	• • •	SW3001A SW3002A SW3003A	15A @ 125V AC 6A @ 250V AC			• • •
S831 S832 S833	30A @ 125V AC 30A @ 250V AC	• • •	• • •	• • •	SW3006A	20A @ 125V AC 10A @ 250V AC	•	•	•
S831D S832D S833D	30A @ 30V DC 1.5A @ 125V DC	• • •	• • •	• • •	SW3007A	15A @ 125V AC 6A @ 250V AC			•
SB25	1.5A @ 125V AC 9A @ 250V AC	•	•	•	SW3821 SW3822 SW3823	30A @ 125V AC 30A @ 250V AC	• • •	• • •	• • •
SB61A	10A @ 125V AC 5A @ 250V AC	•	•		SW3821D SW3822D SW3823D	30A @ 30V DC 1.5A @ 125V DC	• • •	• • •	• • •
SB221NC SB221TNC	3A @ 125V AC 1.5A @ 250V AC	• •	• •	• •	SW3831 SW3832 SW3833	30A @ 125V AC 30A @ 250V AC	• • •	• • •	• • •
SB221NO SB221TNO	3A @ 125V AC 1.5A @ 250V AC			• •	SW3831D SW3832D SW3833D	30A @ 30V DC 1.5A @ 125V DC	• • •	• • •	• • •
SB265	6A @ 125V AC 3A @ 250V AC	•	•	•	UB15 UB16 UB25 UB26	5A @ 125V AC 5A @ 250V AC 0.014A @ 28V DC	• • • •	• • • •	
SB4011NC SB4011NO	3A @ 125V AC 2A @ 250V AC	• •	• •	• •	UB15 UB16 UB25 UB26	5A @ 125V AC 5A @ 250V AC 0.4VA @ 28V DC 5A @ 30V DC			• • • •
<u>Low Security</u> SK12AA SK12BA SK13DA SK13EA	3A @ 125V AC 1A @ 250V AC	• • • •	• • • •	• • • •	UB215 UB216 UB225 UB226	5A @ 125V AC 5A @ 250V AC 0.014A @ 28V DC	• • • •	• • • •	
<u>Medium Security</u> SK12AD SK12BD SK13ED	3A @ 125V AC	• • •	• • •		WR11 WR12 WR13 WR15 WR18 WR19	15A @ 125V AC 15A @ 250V AC 15A @ 30V DC	• • • • • •	• • • • • •	
					YB15 YB16 YB25 YB26	3A @ 125/250V AC 0.4VA @ 28V AC/DC (Solder Lug only)	• • • •	• • • •	• • • •
					YB15 YB16 YB25 YB26	3A @ 125/250V AC 0.4VA @ 28V AC/DC	• • • •	• • • •	• • • •
					YB215 YB216 YB225 YB226	3A @ 125/250V AC 0.4VA @ 28V AC/DC	• • • •	• • • •	

Toggles

Rockers

Pushbuttons

PB

Illuminated

Programmable

Keylocks

Rotaries

Slides

Tactiles

Tilt

Touch

Indicators

Accessories

Supplement **Z**

# Standards & Approvals

## VDE (Verband Deutscher Elektrotechniker/Germany)

VDE Approved				VDE Approved			
Models	Approved Ratings	File or License Numbers	Marking on Case	Models	Approved Ratings	File or License Numbers	Marking on Case
JPL	8A/128A @ 250V AC 16A (8A) @ 250V AC	097579	Standard	JWS	5A (3A) @ 125/250V AC	119153	Standard
JPM	5A/80A @ 250V AC 10A (6A) @ 250V AC	113494	Standard	P	10A (6A) @ 125V AC 6A (6A) @ 250V AC	119174	Standard
JWL	8A/128A @ 250V AC 16A (8A) @ 250V AC	115637	Standard	SW3006A	20A @ 125V AC 10A @ 250V AC	119189	On Request
JWM	5A/80A @ 250V AC 10A (6A) @ 250V AC	115637	Standard	WR	15A (8A) @ 250V AC	126501	On Request

## ISO (International Organization for Standardization)

### ISO 9001

ISO 9000 is a set of international standards on quality management and quality assurance. It is not a set of product specifications but requirements for building a quality system with documented and repeatable procedures.

NKK has received the certificate of registration for the ISO 9001 standard, which is for business operations that design, produce, install, and service products.

### ISO 14001

ISO 14000 is a new series of voluntary international standards governing environmental management. ISO 14001 is the first of some 20 standards to be developed.

NKK, being a corporation mindful of environmental concerns, has obtained a certificate of registration for ISO 14001. This standard seeks to balance socio-economic and business needs with support of environmental protection and pollution prevention within reach of businesses large and small.

## IP Code for Degrees of Protection Provided by Enclosures

The IP code is part of the IEC60529 (International Organization for Standardization) standard recommending the degree of protection of enclosures for low-voltage switch gear; specifically, concerned with protection of persons against contact with live or moving parts and the prevention of ingress of solid foreign bodies and liquid.

The IP code is an industrial specification used internationally and is similar to the NEMA standard.

<b>IP60</b>	dust tight but not protected from water.
<b>IP65</b>	dust tight and protected against water jets.
<b>IP67</b>	dust tight and protected against effects of temporary immersion.

# Terms & Acronyms

Toggles

Rockers

Pushbuttons

Illuminated PB

Programmable

Keylocks

Rotaries

Slides

Tactiles

Tilt

Touch

Indicators

Accessories

Supplement

## A

<b>AC</b>	Alternating Current; electric current that continually reverses direction at a fixed frequency
<b>alloy</b>	A metal created by combining two or more different metals to obtain a desired physical property
<b>alternate action</b>	Commonly describing pushbutton switches; remaining in a given circuit condition after removal of actuating force; when actuating force is applied a second time, the opposite circuit is engaged; also known as push-push switching action; may or may not be latchdown
<b>ambient temperature range</b>	Operating temperature range
<b>angle of throw</b>	Used with rockers and toggles to indicate total travel arc measured in degrees
<b>annealed</b>	Relieved of mechanical stress through the application of heat and gradual cooling; for example, annealed copper is less brittle
<b>ANSI</b>	American National Standards Institute; a standard-setting agency of the United States which approves the design and/or performance of electrical/electronic components that are distributed in the world market
<b>arcing</b>	The flow of electric current between opening or closing switch contacts
<b>AWG</b>	American Wire Gauge. Sizes may be determined by measuring the diameter of the conductor (the bare wire) with the insulation removed.

## B

<b>bifurcated contact</b>	A two-pronged, wiping movable contact
<b>bounce</b>	The repeated rebounding of the movable contact during the transfer from one throw to the next; measured in milliseconds
<b>brass</b>	An alloy of zinc and copper
<b>break before make</b>	Interrupting one circuit of a pole before completing another of the same pole (nonshorting contact)

## C

<b>capacitive load</b>	A load in which the initial current on make is higher than steady state; upon break it is less than steady state. Current leads voltage in capacitive loads
<b>clad</b>	The joining of two dissimilar materials by welding or bonding
<b>cleaning</b>	Automated cleaning for process sealed devices, manual cleaning for unsealed devices. Cleaning is needed to remove flux from terminals and PC boards
<b>contact resistance</b>	The resistance across a pair of closed contacts which is in series with the load; this resistance increases with the age of the switch at a rate varied by environment, frequency of use, voltage, and load conditions; measured in milliohms
<b>convection reflow</b>	Automated soldering of surface mount devices by running the PC board with the attached components through a soldering convection oven

**coplanarity** The profile of the surface tolerance establishes a tolerance zone defined by two parallel planes some distance apart within which all considered surfaces must lie

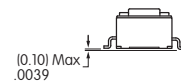

HPO3 Series

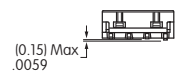

All other SMTs

**creepage** The unwanted flow of electrical current from one conductive part to another

**CSA** Canadian Standards Association



**cULus** Underwriters Laboratories Inc. - indicates compliance with both Canada and US requirements



**cycle** The complete sequence of indexing through all successive switch positions and returning to the original position

# Terms & Acronyms

## D

<b>DC</b>	Direct Current; electric current that flows only in one direction
<b>detent</b>	A mechanical positioning device for stopping actuator travel at each successive electrical circuit; for example, a spring-operated ball and groove
<b>dielectric strength</b>	The ability of an insulating material to withstand high voltage without electrical degradation
<b>differential travel</b>	The distance an actuator moves between the point where contacts snap over and where they snap back, or where a contact makes and then breaks
<b>DIP</b>	Dual Inline Package, indicating .100" center-to-center terminal spacing and .300" row-to-row spacing
<b>double break</b>	Having two pairs of contacts (shorting bar) that open the circuit at two places; having this added contact material improves heat dissipation and increases life; desirable in DC circuit applications
<b>DP</b>	Double Pole; see pole
<b>dry circuit</b>	A low energy circuit condition where no arcing occurs during contact switching; for example, 0.4VA maximum @ 28V AC/DC maximum; see logic level
<b>DSP</b>	National Defense Standards of Japan; NKK file numbers C 6310B & C 6313
<b>DT</b>	Double Throw; see throw
<b>dust cover</b>	Protects switch in an environment where small particles and dust exist; switch is operable with dust cover in place

## E

<b>environmentally sealed</b>	Protected for use in harsh environments
-------------------------------	---

## F

<b>flash plating</b>	A very thin or "instant plating" of usually less than 10 microinches in thickness
<b>flow soldering</b>	Automated soldering of through-hole devices on PC boards, also known as wave soldering
<b>flux</b>	Chemical used for cleaning metal surfaces so that solder will flow out on the metal; fluxes change a passive, contaminated metal surface into an active, clean, solderable surface
<b>forward voltage (<math>V_F</math>)</b>	The typical voltage drop across the LED at the typical forward current.

## G

<b>gull wing</b>	A type of surface mount terminal which extends from side of switch and has an L-shaped bend at the end
------------------	--

## H

<b>horsepower</b>	Horsepower, a unit of work, is often found as a rating on electrical motors. One horsepower is equal to 746 watts.
-------------------	--

## I

<b>inductive load</b>	A load in which the initial current on make is lower than steady state and upon break is greater than steady state. The long arcing time, due to stored energy in the inductor at the time of breaking, is severe on the switch contacts.
-----------------------	---

<b>IEC</b>	International Electrotechnical Commission 3 Rue de Varembe P. O. Box 131 1211 Geneva 20, Switzerland
------------	---



# Terms & Acronyms

Toggle

**IECQ** IEC's Quality Assessment System for Electronic Components, created in 1983 to facilitate national and international trade in certified electronic components; a worldwide certification system which provides a method whereby electronic components made and handled by approved manufacturers and distributors can be used anywhere without further testing.

Rockers

**infrared reflow** A method of mass soldering surface mount devices with some form of infrared (IR) thermal radiation, such as a lamp IR system where PCB and components are heated largely by radiant energy from IR lamps

Pushbuttons

**inrush** The initial, transitory high-level of current through contacts upon making (closing); can cause severe degradation of contacts; applicable to resistive and capacitive loads

**insulation resistance** The electrical resistance between two normally insulated parts; measured at a specific high potential; usually greater than 1 megohm

Illuminated PB

**IP** Ingress Protection (IP) rating system for definition of level of water and dust protection

**ISO** ISO, International Standards Organization, is a network of the national standards institutes of 146 countries, on the basis of one member per country, with a Central Secretariat in Geneva, Switzerland, that coordinates the system

Programmable

**isolated lamp circuit** Independent of switching circuit; lamp is operated on a circuit separate from the switch circuit

## J

Keylocks

**JEITA** Japan Electronics and Information Technology Industries Association

**JETL** Japan Electrical Testing Laboratory



**JIS** Japan Industrial Standard; Japan Industrial Standards Committee (JISC)  
Agency of Industrial Science and Technology



Rotaries

## L

**lamp load (tungsten)** Most notably characterized by the high inrush current at make (approximately 10 to 16 times the steady state)

Slides

**latchdown** One type of alternate action in which the pushbutton is mechanically fastened in the down position; the pushbutton is at "normal" position for one circuit and latched down position for the other circuit condition

**LED** Light Emitting Diode; provides illumination with advantages of long life and low power consumption

Tactiles

**logic level** An application in which power levels do not cause arcing, melting, or softening of contacts; also referred to as dry circuit or low energy; specified 0.4VA maximum @ 28V AC/DC maximum; typically requiring gold contacts for reliability

**low level** Devices that are used in a low level circuit (low voltage and low current) have not been tested by UL and/or CSA. When used as intended in a low level circuit, the results do not produce hazardous energy.

Tilt

**luminous intensity** The luminous intensity is the luminous flux emitted from a point per unit solid angle into a particular direction. Standard unit of luminous intensity is Candela (cd), also expressed as Lumen per Steradian (lm/sr).

## M

Touch

**maintained action** Remaining in a given circuit condition until actuated to the opposite circuit condition where it is again maintained; opposite momentary action

Indicators

**make before break** Completing one circuit of a pole before interrupting another of the same pole (shorting contact)

**maximum forward current ( $I_{FM}$ )** The maximum continuous operating current at 25°C that the LED can withstand. Exceeding the recommended voltage results in serious degrading or destruction of the LED. Operation should be well below the limit.

Accessories

**maximum reverse voltage ( $V_{RM}$ )** The maximum voltage in the opposite direction that the LED can withstand. Exceeding the recommended voltage results in serious degrading or destruction of the LED. Operation should be well below the limit.

**MITI** Ministry of Industry & Trade Institute (Japan)

Supplement

**momentary action** Mechanically returning from a temporary circuit condition to the normal circuit condition as soon as the actuating force is removed

Z

# Terms & Acronyms

**motor load** Most electric motors are designed to run at 50% to 100% of rated load. Maximum efficiency is usually near 75% of rated load. Thus, a 10-horsepower (hp) motor has an acceptable load range of 5 to 10 hp; peak efficiency is at 7.5 hp. A motor's efficiency tends to decrease dramatically below about 50% load.

**MSCP** Mean Spherical Candle Power; a unit of measure of light intensity

## N

**NC** Normally Closed contacts; circuit is closed when actuator is in relaxed or normal position

**NEMA** National Electrical Manufacturers Association, an agency of the United States setting standards for products distributed worldwide; applied to switches in their degrees of protection against the intrusion of liquids, dust, other contaminants

**Newton** The unit of measure for operating force abbreviated N; see the conversion tables in the previous section

**NO** Normally Open contacts; circuit is open when actuator is in relaxed or normal position; applies to momentary or alternate action switches

**nominal** The result of the calculated actual value range

**nonshorting contacts** Contacts which break before make

**nonswitching rating** The power carrying capability of a switch after contact closure and at the end of contact bounce; usually much higher than the switching rating

## O

**opaque** Condition that prevents the passage of light

**overtravel** The distance an actuator moves beyond the point at which electrical contacts transfer

## P

**panel seal** Liquid is prevented from reaching the switch contacts from front of the panel if panel is subjected to spills or splashing

**PCB** Printed Circuit Board; thin copper traces on a plastic laminate providing low cost, low current mass wiring

**PF** Power Factor; a means of determining contact capability when used with inductive loads relative to the standard resistive load rating; for example, if PF = 1.0 the inductive load is 100% of the resistive load, or if PF = 0.6 the inductive load is 60% of the resistive load

**photo interrupter** Light source being interrupted and thus changing the status of an electrical circuit

**pole** A single common electrical input having one or more outputs

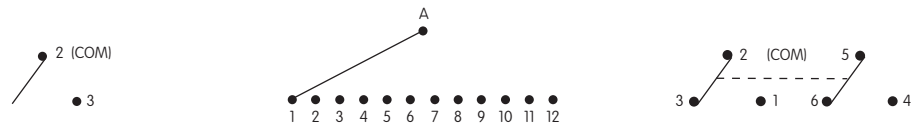

**Single Pole** (with 1 output)

**Single Pole** (with 12 outputs)

**Double Pole** (with 2 outputs)

**position** The mechanical detents of a switch actuator

**PPS** Polyphenylene sulfide; a thermoplastic resin which is chemical and flame resistant

**pretravel** The distance an actuator moves before a change in the electrical condition is made

**process compatible** Capable of subjection to automated cleaning procedures after wave soldering; often noted as "washable"

**process sealed** Sealed to withstand the entire automated processing including the final cleaning

**protective guard** Prevents accidental actuation; switch is not operable when protective guard is in place

**push-push** Also known as alternate action; is not latchdown

# Terms & Acronyms

Toggle

Rockers

Pushbuttons

Illuminated PB

Programmable

Keylocks

Rotaries

Slides

Tactiles

Tilt

Touch

Indicators



Accessories

Supplement

## R

- RCJ** Reliability Center for Electronic Components of Japan, member of EXACT (International Exchange of Authenticated Electronic Component Performance Test Data) 
- resistive load** The easiest load to switch because current and voltage are in a steady state on make and drop instantly to zero on break; produces minimal arcing which maximizes contact life
- RMS** Root Mean Square
- RoHS** Restriction of Hazardous Substances in Electrical and Electronic Equipment directive restricting the use of lead, cadmium, mercury, hexavalent chromium and PBB/PBDE flame retardant materials in electrical and electronic products sold in Europe beginning July 1, 2006

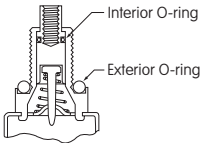
## S

- shorting contacts** Contacts which make before break
- silicone rubber** Rubber made from silicone elastomers and noted for its retention of flexibility, resilience, and tensile strength over a wide temperature range
- SIP** Single Inline Package, indicating .100" center-to-center terminal spacing with terminals aligned in one row
- snap action** The abrupt transfer of contacts from one position to another; this action is relatively independent of the speed of actuator travel
- splashproof** Prevents entry of liquids at front panel generally by means of one or two internal o-rings, as illustrated here 
- SPST** Single Pole Single Throw; see pole, also throw
- STC** Sliding Twin Contact, a mechanism with two movable contact surfaces which pinch the stationary contacts. The STC contact mechanism provides smooth, positive detent actuation, unparallelled logic-level reliability, and more contact stability than conventional mechanisms. Continued reliability is assured since the gold-plated contacts are wiped clean with each actuation. Furthermore, if one side of the twin contacts should fail to conduct, the other side functions as a backup or a fail-safe path for the current. The combination of rounded movable and stationary contacts provides the smooth contact feel not found previously in sliding contact type mechanisms. 
- surface mount SMD or SMT** Component terminals are soldered to pads on the surface of the PC boards as opposed to using holes for mounting; terminal shapes vary – gull wing, J-bend, and others
- synchronous lamp circuit** Lamp is operated on a circuit in phase with the switch; the switch contains a separate circuit to open or close the lamp circuit simultaneously with the switching circuit

## T

- tactile feedback** The switching action felt by an operator
- tamperproof** Designed to prevent tampering or provide evidence of tampering; impervious to tampering
- tamper resistant** Designed to make tampering difficult or resistive
- thermal shock** The state of a component that is undergoing an excessive temperature change, particularly in reference to movement from one process to another in soldering and cleaning
- thermoplastic** A plastic which is flexible and easily molded when heated and which becomes hard and rigid when cooled
- thermoset** A plastic which becomes hard and rigid when heated or cured
- throw** The number of electrical circuits within a pole

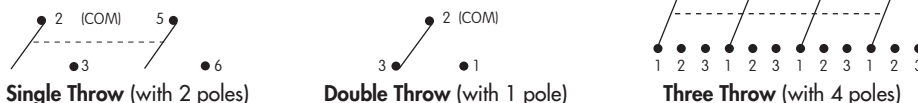



# Terms & Acronyms

<b>total travel</b>	Sum of pretravel and overtravel; full distance an actuator moves from relaxed position past the point of electrical contact and to the end of travel
<b>translucent</b>	Transmitting and diffusing light so that objects beyond cannot be seen clearly
<b>transparent</b>	Transmitting light without appreciably scattering so that objects lying beyond are entirely visible
<b>travel</b>	The distance the actuator moves to effect the change of electrical circuits; see also differential travel, pretravel, overtravel, and total travel
<b>two circuit</b>	Circuit in which one circuit is completed in one position and another separate circuit is completed in the other position
<b>typical forward current (I<sub>F</sub>)</b>	The test condition at 25°C. It is recommended that the current be at or below the Typical Forward Current.

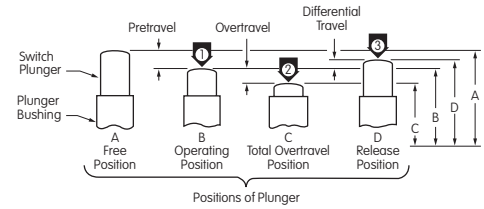

## U

**UL** Underwriters Laboratories Inc.; many of NKK's switches are UL Recognized



**undercoating** A coating used for preparation of a surface for plating or used to prevent corrosion when the finish plating develops pinholes; thickness of an undercoating is determined by its purpose

## V

**vapor phase** A process well-suited to soldering surface mount devices; it combines infrared preheating with condensation heating for reflow, advantageous for eliminating overheating of components and PCB

**VDE** Verband Deutscher Elektrotechniker of Germany



## W

**watertight** Impermeable to water except when subjected to immersion; not waterproof

**wavelength** The color of visible light is measured by its wavelength. The Greek symbol "lambda" is used to represent wavelength, the unit of measure is nm.

**wave soldering** A method of soldering in which a wave of molten solder contacts surfaces as the PC board with components is conveyed through the process; wave width, travel speed, dwell time, etc. are varied to achieve desired results

**WEEE** Waste Electrical and Electronic Equipment  
Directive aims at prevention of WEEE and its reuse, recycling and recovery, so as to reduce the disposal of this type of waste. The directive sets targets for the separate collection of WEEE, along with standards for treatment and targets for recycling and recovery.

**wiping action** Sliding of contacts over one another resulting in cleaning of the surfaces

## FEDERAL SUPPLY CODE

NKK Switches has been assigned the  
FSC Number 63426  
and is classified as a  
Commercial and Governmental Entity (CAGE)  
by the Defense Logistics Agency  
in Battle Creek, Michigan.

# Product Overview

## Ultra-Miniature & Subminiature

Toggles

Rockers

Pushbuttons

- Toggles
- Rockers
- Pushbuttons
- Slides

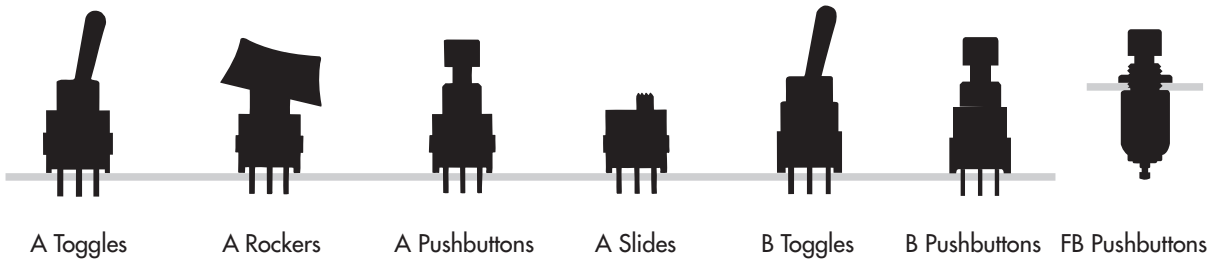

A Toggles    A Rockers    A Pushbuttons    A Slides    B Toggles    B Pushbuttons    FB Pushbuttons

## Miniature

Programmable

Keylocks

- Toggles
- Rockers
- Pushbuttons
- Slides

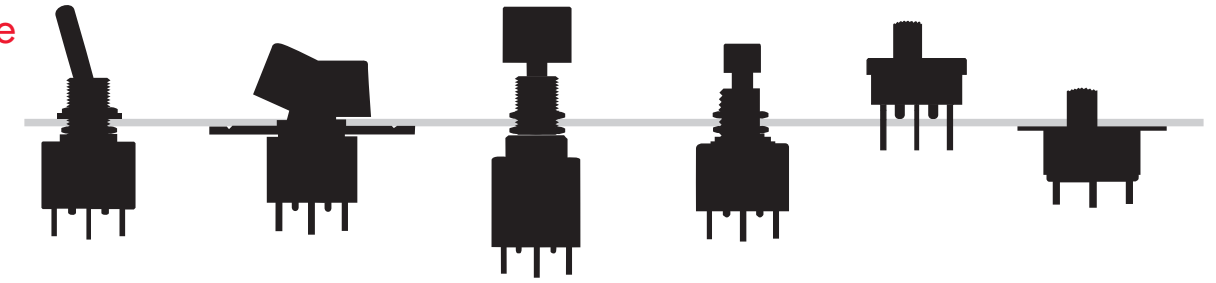

M Toggles    M Rockers    MB2000    MB2400    CS Slides    MS Slides

## Specialty

Rotaries

Slides

- Rotaries
- DIP Rotaries
- Tactiles
- Slides
- Keylocks
- Tilt Switches



FR01    ND    SM    SS    CB    HP02    JB    JB    JF    JS  
FR02    ND3    SS3    CB3    HP03

## Illuminated

Tactiles

Tilt

- Toggles
- Rockers
- Pushbuttons
- Tactiles
- Slides

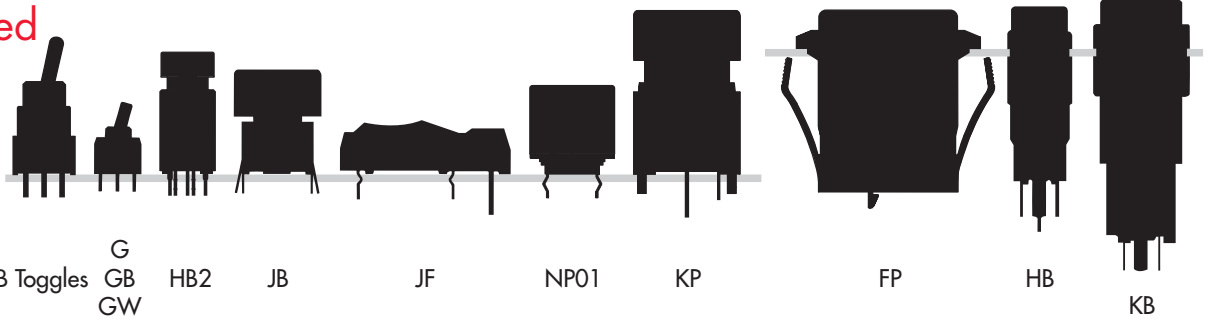

B Toggles    G    HB2    JB    JF    NP01    KP    FP    HB    KB  
GB    GW

## Standard & High Capacity

Touch

Indicators

Accessories

- Toggles
- Rockers
- Pushbuttons
- Rotaries

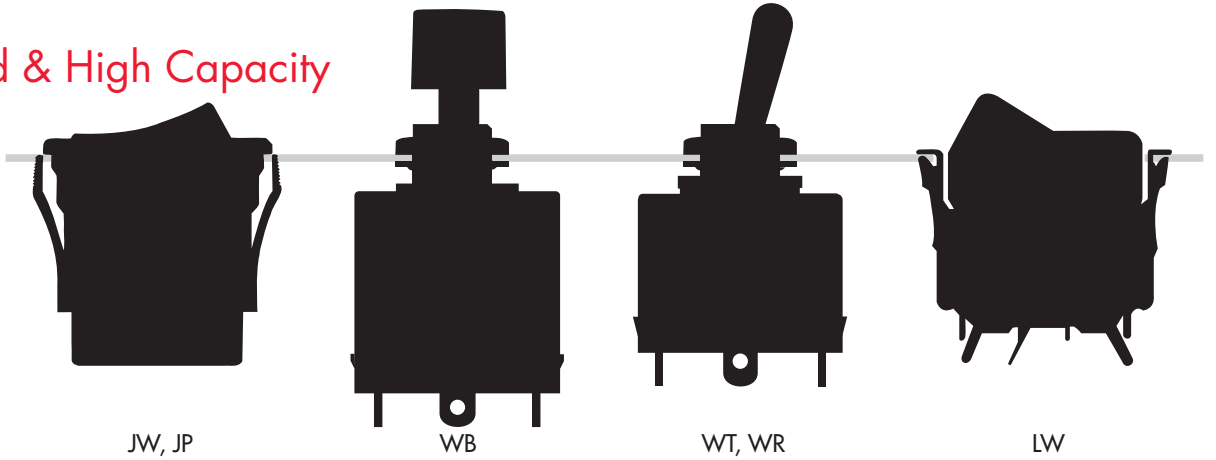

JW, JP    WB    WT, WR    LW

Supplement



# Product Overview

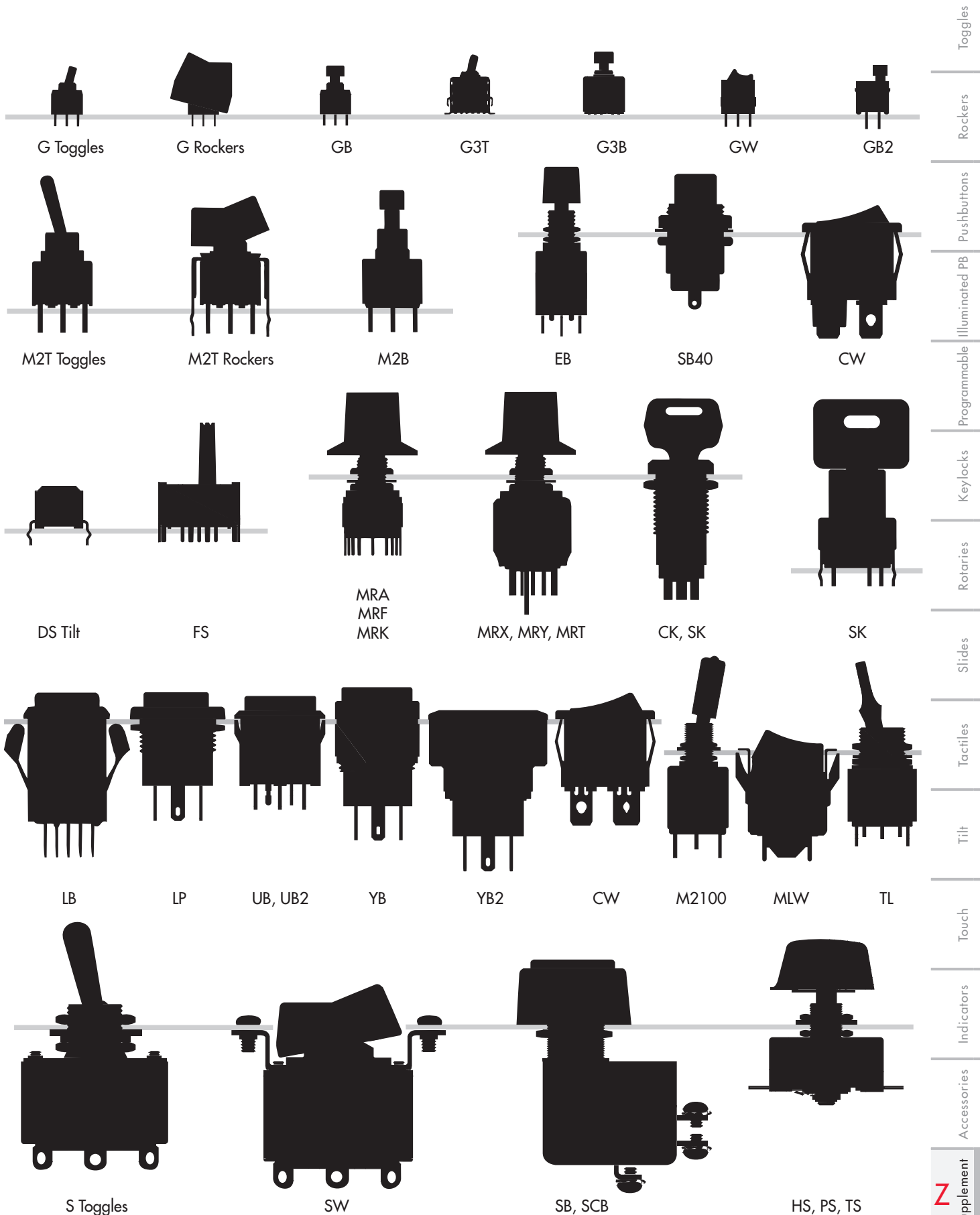

# Index by Model Number

Toggles

Rockers

Pushbuttons

Illuminated PB

Keylocks

Rotaries

Slides

Tactiles

Tilt

Touch

Indicators

Accessories

Supplement

MODEL	PAGE NO.	MODEL	PAGE NO.	MODEL	PAGE NO.	MODEL	PAGE NO.
A01	M3-4	A29K1	B4-11	CWSB21 (Illum)	B18-21	G12 (Illum)	A38-41
A11	A4-11	A2SK1	B4-11	CWSC11 (Illum)	B22-27	G13 (Illum)	A38-41
A12	A4-11	AB11	C6-11	CWSC21 (Illum)	B22-27	G12K	B28-31
A13	A4-11	AB15	C6-11	CWT12	B12-17	G13K	B28-31
A15	A4-11	AB25	C6-11	D22012	A24-33	G15K	B28-31
A1R	A4-11	AS11	H4-9	D22013	A24-33	G18K	B28-31
A18	A4-11	AS12	H4-9	D22015	A24-33	G19K	B28-31
A19	A4-11	AS13	H4-9	D22018	A24-33	G22K	B28-31
A1S	A4-11	AS22	H4-9	D22019	A24-33	G23K	B28-31
A12K	B4-11	AS23	H4-9	D22022	A24-33	G25K	B28-31
A13K	B4-11	AS24	H4-9	D22023	A24-33	G28K	B28-31
A15K	B4-11	AT016-9704	Y1-34	D22025	A24-33	G29K	B28-31
A1RK	B4-11	B12	A12-19	D22028	A24-33	GB15	C44-47
A18K	B4-11	B13	A12-19	D22029	A24-33	GB25	C44-47
A19K	B4-11	B15	A12-19	D22042	A24-33	GB15 (Illum)	D8-11
A1SK	B4-11	B1S	A12-19	DB2511	C18-23	GB215	C48-51
A12K1	B4-11	B18	A12-19	DB2521	C18-23	G3B15	C52-57
A13K1	B4-11	B19	A12-19	DSA01	K3-10	G3B25	C52-57
A15K1	B4-11	B22	A12-19	DSBA1P	K3-10	G3T12	A42-47
A1RK1	B4-11	B23	A12-19	DSBA1H	K3-10	G3T13	A42-47
A18K1	B4-11	B25	A12-19	EB2011	C24-37	G3T15	A42-47
A19K1	B4-11	B2R	A12-19	EB2061	C24-37	G3T18	A42-47
A1SK1	B4-11	B28	A12-19	EB2065	C24-37	G3T19	A42-47
A22	A4-11	B29	A12-19	EB2085	C24-37	G3T22	A42-47
A23	A4-11	B2S	A12-19	FB15AN	C38-41	G3T23	A42-47
A24	A4-11	B12 (Illum)	A20-23	FM	L14	G3T25	A42-47
A25	A4-11	B13 (Illum)	A20-23	FP01	D4-7	G3T28	A42-47
A2R	A4-11	BB15	C12-17	FR01	G4-11	G3T29	A42-47
A26	A4-11	BB16	C12-17	FR02	G12-15	GW12	B32-35
A27	A4-11	BB25	C12-17	FS22	H14-17	GW22	B32-35
A28	A4-11	BB26	C12-17	FT	L3	GW12 (Illum)	B36-39
A29	A4-11	CB15	J4-7	G01	M5	HB01	M6-7
A2S	A4-11	CB315	J8-11	G12	A34-37	HB02	M6-7
A22K	B4-11	CKL12	F3-8	G13	A34-37	HB15	D12-17
A23K	B4-11	CKL13	F3-8	G15	A34-37	HB16	D12-17
A24K	B4-11	CKM12	F3-8	G18	A34-37	HB215	D18-21
A25K	B4-11	CKM13	F3-8	G19	A34-37	HP0215	J12-15
A2RK	B4-11	CS12	H10-13	G22	A34-37	HP0315	J16-19
A26K	B4-11	CS22	H10-13	G23	A34-37	HS13-X	G46-47, 50
A27K	B4-11	CWSA11	B12-17	G25	A34-37	HS13-Y	G46-47, 50
A28K	B4-11	CWSA12	B12-17	G28	A34-37	HS13-Z	G46-47, 50
A29K	B4-11	CWSB11	B12-17	G29	A34-37		
A2SK	B4-11	CWSB21	B12-17				

# Index by Model Number

MODEL	PAGE NO.	MODEL	PAGE NO.	MODEL	PAGE NO.	MODEL	PAGE NO.
HS16-1	G46-47, 50	JWL22	B40-49	M2022	A48-79	M2112J, P	B92-97
HS16-2	G46-47, 50			M2023	A48-79	M2113N, R	B92-97
HS16-3	G46-47, 50	JWM21	B40-49	M2024	A52-79	M2113J, P	B92-97
HS16-4	G46-47, 50	JWM22	B40-49	M2025	A52-79	M2122N, R	B92-97
HS16-5	G46-47, 50	JWLW21	B40-49	M2026	A52-79	M2122J, P	B92-97
HS16-6	G46-47, 50	JWLW22	B40-49	M2027	A52-79	M2123N, R	B92-97
		JWMW21	B40-49	M2028	A48-79	M2123J, P	B92-97
		JWMW22	B40-49	M2029	A52-79		
ISO1BBF	E39-40					M2B15	C64-71
ISO1EBF	E26-27					M2B25	C64-71
IS15BAF	E35-38	JWS11	B50-55	M2032	A52-79		
IS15BBF	E35-38	JWS21	B50-55	M2033	A52-79		
IS15BSA	E41-47			M2035	A52-79	M2T12	A82-89
IS15BSB	E41-47	KB01	M9-13	M2038	A52-79	M2T13	A82-89
IS15EBF	E22-25	KB02	M9-13	M2039	A52-79	M2T15	A82-89
IS15ESB	E28-33	KB03	M9-13			M2T18	A82-89
IS18WW	E15-20	KB04	M9-13	M2042	A52-79	M2T19	A82-89
ISCO1P	E11-14	KB05	M9-13	M2043	A52-79		
ISC15AN	E8-14	KB06	M9-13	M2044	A52-79	M2T22	A82-89
ISF15AC	E4-7			M2045	A52-79	M2T23	A82-89
		KB15	D22-35	M2046	A52-79	M2T25	A82-89
JB15FH	J20-27	KB16	D22-35	M2047	A52-79	M2T28	A82-89
JB15FP	J20-27	KB25	D22-35	M2048	A52-79	M2T29	A82-89
JB15HAP	J20-27	KB26	D22-35	M2049	A52-79		
JB15KH	J20-27					M2T12TX	B98-105
JB15KP	J20-27	KP0115	D36-47	M2012T	B62-91	M2T13TX	B98-105
		KP0215	D36-47	M2013T	B62-91	M2T15TX	B98-105
JB15LP (Illum)	J28-33			M2015T	B62-91	M2T18TX	B98-105
JB15HBP (Illum)	J28-33	LB01	M14-18	M2018T	B62-91	M2T19TX	B98-105
		LB02	M14-18	M2019T	B62-91		
JF01	M8	LB03	M14-18			M2T22TX	B98-105
				M2022T	B62-91	M2T23TX	B98-105
JF15C	J34-39	LB15	D48-58	M2023T	B62-91	M2T25TX	B98-105
JF15S	J34-39	LB16	D48-58	M2024T	B62-91	M2T28TX	B98-105
		LB25	D48-58	M2025T	B62-91	M2T29TX	B98-105
JF15R (Illum)	J40-45	LB26	D48-58	M2026T	B62-91		
JF15A (Illum)	J40-45			M2027T	B62-91	MB2011	C72-95
		LB15W	D59-67	M2028T	B62-91	MB2061	C72-95
JL15	J46-50	LB16W	C59-67	M2029T	B62-91	MB2065	C72-95
		LB25W	C59-67			MB2085	C72-95
JPL16	C58-63	LB26W	C59-67	M2032T	B62-91	MB2181	C72-95
JPL26	C58-63			M2033T	B62-91	MB2185	C72-95
JPM16	C58-63	LP0115	D68-73	M2035T	B62-91		
JPM26	C58-63	LP0125	D68-73	M2038T	B62-91	MB2411	C96-115
				M2039T	B62-91	MB2461	C96-115
JS01	H18-23	LW3021A	B61			MB2511	C116-127
JS03	H18-23			M2042T	B62-91	MB2521	C126-127
		LW3122	B56-60	M2043T	B62-91		
JS02	H24-29	LW3123	B56-60	M2044T	B62-91		
JS04	H24-29	LW3125	B56-60	M2045T	B62-91	MLW3012	B106-113
		LW3128	B46-60	M2046T	B62-91	MLW3013	B106-113
JWL11	B40-49	LW3129	B56-60	M2047T	B62-91	MLW3015	B106-113
JWL12	B40-49			M2048T	B62-91	MLW3018	B106-113
JWM11	B40-49	M2011	A52-79	M2049T	B62-91	MLW3019	B106-113
JWM12	B40-49	M2012	A48-79				
JWLW11	B40-49	M2013	A48-79	M2112L, T	A76-81	MLW3022	B106-113
JWLW12	B40-49	M2015	A52-79	M2113L, T	A76-81	MLW3023	B106-113
JWMW11	B40-49	M2018	A48-79	M2122L, T	A76-81	MLW3025	B106-113
JWMW12	B40-49	M2019	A52-79	M2123L, T	A76-81	MLW3028	B106-113
JWL21	B40-49	M2021	A52-79			MLW3029	B106-113
				M2112N, R	B92-97		

Toggles

Rockers

Pushbuttons

Illuminated PB

Programmable

Key locks

Rotaries

Slides

Tactiles

Tilt

Touch

Indicators

Accessories

Supplement

Z

# Index by Model Number

	MODEL	PAGE NO.	MODEL	PAGE NO.	MODEL	PAGE NO.	MODEL	PAGE NO.
Toggle	MRA112	G16-21	P01	M19-20	S8AW	A100	S302	A103
	MRA206	G16-21			S9AW	A100	S302T	A105
	MRA403	G16-21	P2011	A90-93			S303	A103
Rockers			P2012	A90-93	S21A	A98	S303T	A105
	MRB	G28-33	P2013	A90-93	S21AL	A101		
			P2021	A90-93	S21AW	A100	S305	A103
Pushbuttons	MRF112	G16-21			S21F	A99	S305T	A105
	MRF206	G16-21	P2022	A90-93				
	MRF403	G16-21	P2023	A90-93	S25AW	A100	S308	A103
Illuminated PB	MRK112	G16-21	P2011N	B114-119	S28AW	A100	S308T	A105
	MRK206	G16-21	P2012N	B114-119	S29AW	A100		
	MRK403	G16-21	P2013N	B114-119			S309	A103
Programmable	MRT22	G22-27	P2021N	B114-119	S31	A108	S309T	A105
	MRT23	G22-27	P2022N	B114-119	S31F	A110		
			P2023N	B114-119	S31T	A109	S331	A103
Keylocks	MRX108	G22-27					S331F	A106
	MRX204	G22-27	P2011Y	B114-119	S32	A108	S331R	A104
	MRX402	G22-27	P2012Y	B114-119	S32F	A110	S331T	A105
Rotaries	MRY106	G22-27	P2013Y	B114-119	S32T	A109		
			P2021Y	B114-119	S33	A108	S332	A103
			P2022Y	B114-119	S33F	A110	S332F	A106
Slides	MS12	H30-37	P2023Y	B114-119	S33T	A109	S332R	A104
	MS13	H30-37					S332T	A105
	MS20	H30-37	PS1	G46, 49, 50	S35	A108	S333	A103
Tactiles	MS22	H30-37	PS2	G46, 49, 50	S38	A108	S333F	A106
	MS23	H30-37	PS3	G46, 49, 50	S39	A108	S333R	A104
			PS4	G46, 49, 50			S333T	A105
Tilt	MS12 (Illum)	H38-41	PS5	G46, 49, 50	S41	A108		
	MS13 (Illum)	H38-41			S41F	A110	S335	A103
	NDFC10	G34-37	S1A	A98	S41R	A108	S335F	A106
Touch	NDFC16	G34-37	S1AL	A101	S41T	A109	S335T	A105
	NDFR10	G34-37	S1AW	A100				
	NDFR16	G34-37	S1F	A99	S42	A108	S338	A103
Indicators	NDKC10	G34-37	S2A	A98	S42F	A110	S338R	A104
	NDKC16	G34-37	S2AL	A101	S42R	A108	S338T	A105
	NDKR10	G34-37	S2AW	A100	S42T	A109		
Accessories	NDKR16	G34-37	S2F	A99			S339	A103
	ND3FC10	G38-45	S3A	A98	S43	A108	S339R	A104
	ND3FC16	G38-45	S3AL	A101	S43F	A110	S339T	A105
Supplement	ND3FR10	G38-45	S3AW	A100	S43R	A108		
	ND3FR16	G38-45	S3F	A99	S43T	A109	S421	A111
			S5AW	A100			S421T	A111
				S45	A108	S422	A111	
				S48	A108	S422T	A111	
				S48R	A108	S423	A111	
						S423T	A111	
				S49	A108	S425	A111	
				S49R	A108	S425T	A111	
						S428	A111	
				S114	A96	S428T	A111	
				S116	A96	S429	A111	
				S116R	A96	S429T	A111	
				S301	A103			
				S301F	A106			
				S301T	A105			

# Index by Model Number

MODEL	PAGE NO.	MODEL	PAGE NO.	MODEL	PAGE NO.
S732	A116				
S821	A114	SM03	H42-43	UB215	D92-103
S821D	A115			UB216	D92-103
S822	A114	SS12	H44-48	UB225	D92-103
S822D	A115	SS14	H44-48	UB226	D92-103
S823	A114	SS22	H44-48		
S823D	A115	SS12 (Illum)	H49-52	WB12	C134-138
		SS22 (Illum)	H49-52	WB15	C134-138
S831	A114			WR11	B124-130
S831D	A115	SS312	H53-58	WR12	B124-130
S832	A114	SS314	H53-58	WR13	B124-130
S832D	A115			WR15	B124-130
S833	A114	SW3001A	B120-121	WR18	B124-130
S833D	A115	SW3002A	B120-121	WR19	B124-130
		SW3003A	B120-121		
SB25	C129	SW3006A	B120-121	WT11	A124-130
		SW3007A	B120-121	WT12	A124-130
SB61	C129	SW3008A	B120-121	WT13	A124-130
SB63	C129			WT15	A124-130
		SW3821	B122-123	WT18	A124-130
SB221	C128	SW3821D	B122-123	WT19	A124-130
SB265	C130	SW3822	B122-123		
		SW3822D	B122-123	WT21	A124-130
SB4011NC	C38-43	SW3823	B122-123	WT22	A124-130
SB4011NO	C38-43	SW3823D	B122-123	WT23	A124-130
				WT25	A124-130
SCB15	C131-133	SW3831	B122-123	WT28	A124-130
SCB16	C131-133	SW3831D	B122-123	WT29	A124-130
SCB25	C131-133	SW3832	B122-123		
SCB26	C131-133	SW3832D	B122-123	YB01	M27-34
		SW3833	B122-123	YB02	M27-34
SK12AA	F9-14	SW3833D	B122-123	YB03	M27-34
SK12AD	F9-14			YB04	M27-34
SK12BA	F9-14	TL22	A118-123	YB05	M27-34
SK12BD	F9-14			YB06	M27-34
SK13DA	F9-14	TS1	G46, 48, 50		
SK13EA	F9-14	TS2	G46, 48, 50	YB15	D104-117
SK13ED	F9-14	TS3	G46, 48, 50	YB16	D104-117
		TS4	G46, 48, 50	YB25	D104-117
SK13AE	F15-18	TS5	G46, 48, 50	YB26	D104-117
SK15AE	F15-18				
		UB01K	M21-23	YB215	D118-129
SK12AG	F19-24	UB03K	M21-23	YB216	D118-129
SK12BG	F19-24	UB04K	M21-23	YB225	D118-129
SK14DG	F19-24	UB06K	M21-23	YB226	D118-129
SK14EG	F19-24	UB06BK	M21-23		
SK15BG	F19-24				
		UB15	D80-91		
SK22AG	F19-24	UB16	D80-91		
SK22BG	F19-24	UB25	D80-91		
SK24DG	F19-24	UB26	D80-91		
SK24EG	F19-24				
SK25BG	F19-24	UB201K	M24-26		
		UB204K	M24-26		
SK14DGM	F25-26				

Toggle

Rockers

Pushbuttons

Illuminated PB

Programmable

Key locks

Rotaries

Slides

Tactiles

Tilt

Touch

Indicators

Accessories

Supplement

# Notes

---





# NKK Switches

## Over 65 Years of Innovation

NKK Switches is known throughout the world as the industry leader of electromechanical switches and manufacturer of the widest range of illuminated, process sealed, miniature, specialty, surface mount and programmable switches. With over 3.5 million switch options, all products are designed with innovation, high reliability, customization and a commitment to excellence.

NKK's sales and engineering teams are dedicated to providing technical expertise and outstanding customer support.

Our manufacturing centers are ISO 9001 and ISO 14001 certified and feature state-of-the-art production and testing facilities to assure the highest quality products.

Please visit [www.nkkswitches.com](http://www.nkkswitches.com) for NKK Sales Representatives and Distributors in your area.



**NIKK**  
SWITCHES

[www.nkkswitches.com](http://www.nkkswitches.com)

---

## Available Worldwide

### Over 65 Years of Engineering Excellence

- ▶ Design and Manufacturing of All Products
- ▶ Widest Selection of Electromechanical Switches in the Industry
- ▶ Free Online 3D CAD Models with over 500,000 Product Variations
- ▶ Custom Products for Specific Applications
- ▶ High Quality and Environmentally Safe Products (RoHS, REACH)
- ▶ ISO Certified Facilities



---

Warranty: All NKK products are warranted against defects in workmanship, material and construction for a period of one (1) year from the date of shipment if the products have been properly installed, used, and maintained. There are no express warranties of merchantability or fitness for a particular purpose. Materials, finishes, and component parts are subject to change without notification.



## Corporate Headquarters

### **NKK SWITCHES CO., LTD.**

Kawasaki-shi, Japan

Tel: 81.44.813.8001 / Fax: 81.44.813.8031

[www.nkkswitches.co.jp](http://www.nkkswitches.co.jp)

## Global Offices:

Americas

### **NKK SWITCHES OF AMERICA, INC.**

Scottsdale, AZ USA

Tel: 1.480.991.0942 / Fax: 1.480.998.1435

[www.nkkswitches.com](http://www.nkkswitches.com)

Asia

### **NKK SWITCHES HONG KONG CO., LTD.**

Kwai Chung, N.T., Hong Kong

Tel: 852.2366.6634 / Fax: 852.2366.6803

[www.nkkswitches.com.hk](http://www.nkkswitches.com.hk)

China

### **NKK SWITCHES CHINA, CO., LTD.**

Shanghai, China

Tel: 86.21.6249.6574 / Fax: 86.21.6248.3375

[www.nkkswitches.com.cn](http://www.nkkswitches.com.cn)

Europe

### **NKK SWITCHES CO., LTD.**

Frankfurt, Germany

Tel: 49.61.96.400.187 (English) / 49.61.96.400.189 (Deutsch)

[www.nkkswitches.eu](http://www.nkkswitches.eu)