

Electromechanical Cam Timer 882565 Part number 88256506



Relay output

- Mono-function
- Mono-range
- Mono-voltage
- Manual reset
- Progress of cycle displayed
- Output : 1, 2 or 3 changeover contacts (max of 16 A per contact)
- Mounting option

Part numbers

	Type	Voltage	Relay outputs	Breaking capacity per contact	Version	Maximum available timing	Dial graduation
88 256 506	882565	127/230 V AC 50 Hz	2 timed	16 A	5 min	4 min 40 s	15 s

Specifications

Precision limit error	± 4 %
Timed two-pole	1 or 2 or 3
Thermal rating	20 A
Mechanical life (operations)	> 10 ⁷
Rating (cos φ = 0.41) 10 ⁴ operations	16 A - 230 V
Voltage variation at maximum temperature of 55 °C according to IEC 255 100	+10 % -15 % Un
Absorbed power-motor	3,1 VA cos φ 0,8
Operating factor	100 %
Temperature limits use (°C)	-5→+70
Temperature limits stored (°C)	-40→+80
Environmental protection Protected metal components - Insulated motor coil	■
Vibration withstand on 3 axes (Veritas standard)	4 G - 55 Hz
Dielectric test voltage according to IEC 255-5 or VDE 0435	1000 V - Un ≤ 60 V
Insulation according to standard VDE 0110 group C	380 V AC 440 V DC
Protection : terminal	IP10
Operating position- any	■
Connection : Tags	6,35
Connection : Motor leads	250 mm
Mounting by screw	2 x M3 - 2 x M4
Weight (g)	225 / 245

Accessories

Accessories	Code
Invertor for DC supply 24-48 V DC	84 861 501
Invertor for DC supply 110-127 V DC	84 861 503

Dimensions (mm)

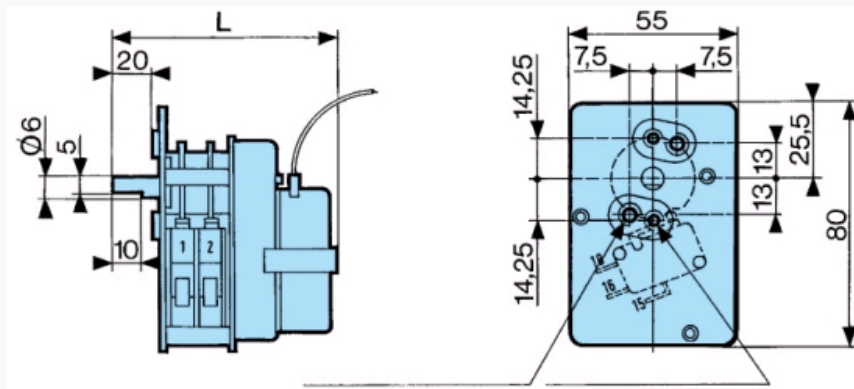

Dimensions (mm)

Panel cut-out

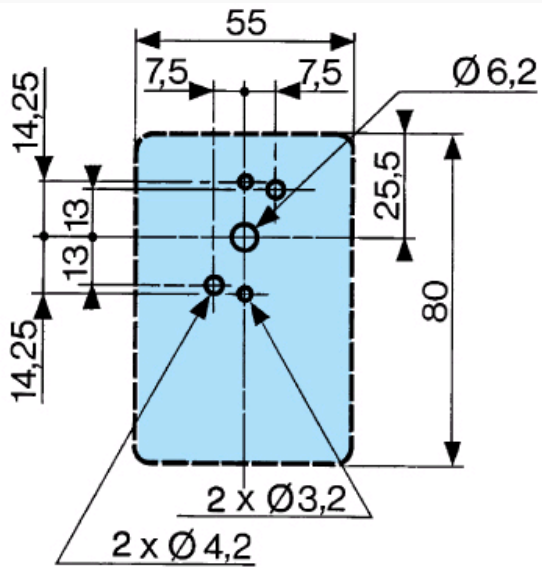

Dimensions (mm)

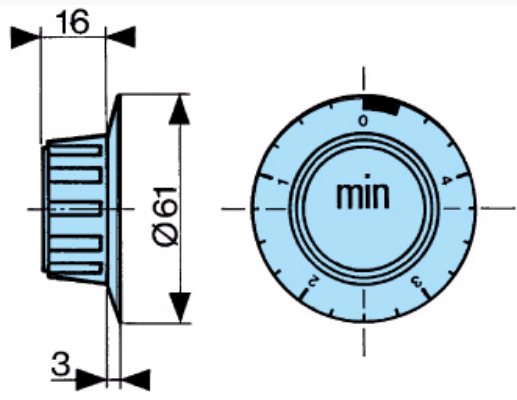

Dimensions (mm)

Inverter for DC supply
 84 861 501 : 24 • 48 V DC
 84 861 503 : 110 • 127 V DC
 Weight 150 g

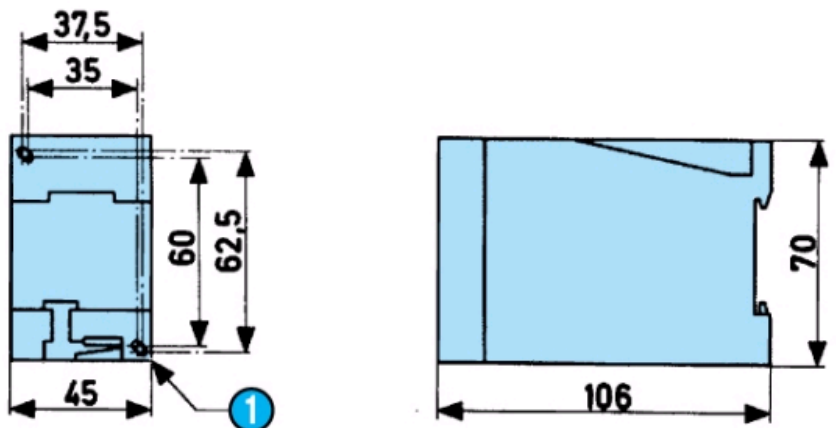

[48 V DC](#)

[84 861 503 : 110 • 127 V DC](#)

[Weight 150 g" class="link_produits thickbox"> Zoom](#)

N°	Legend
1	Fixing holes Ø5

Curves

2 poles

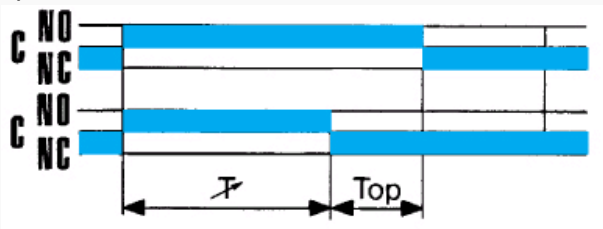

Connections

2 poles

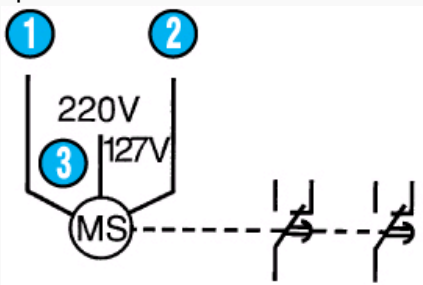

N°	Legend
1	Red
2	Blue
3	White

Connections

2 poles

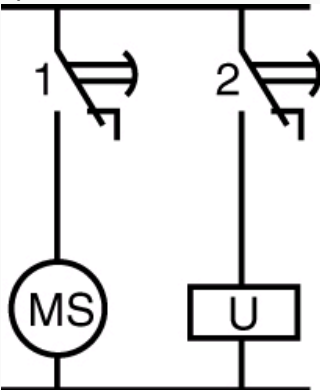

Connections

2 poles

