

## Data sheet | Item number: 750-963

Fieldbus Connector CANopen; with D-sub female connector; 9-pole

[www.wago.com/750-963](http://www.wago.com/750-963)

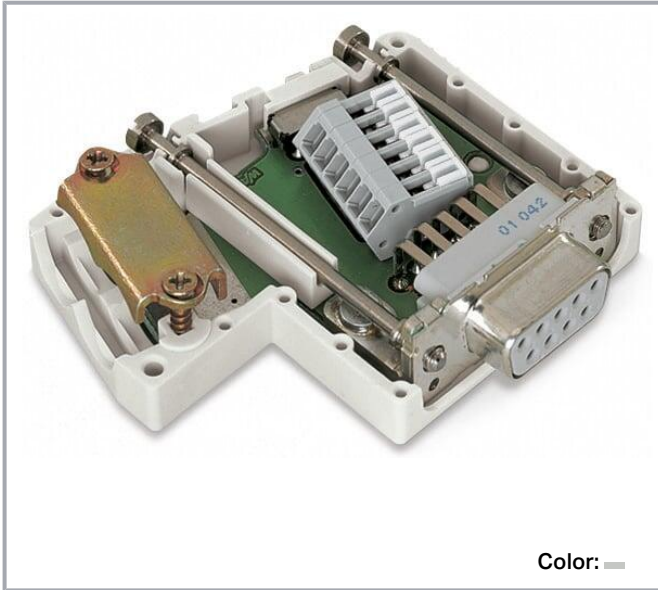

Color: —

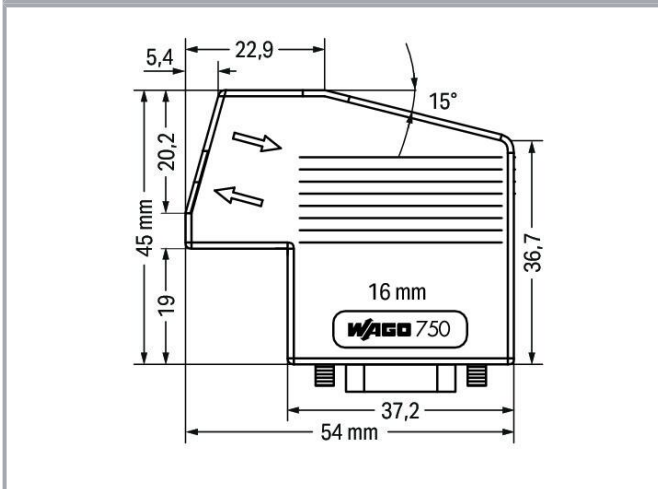
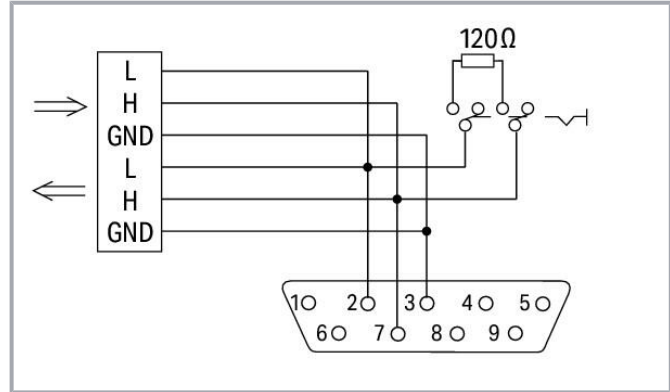

### Item description

This fieldbus connector links a CANopen device to a CANopen line.

The fieldbus connector has the following features:

- Two horizontal cable entries for both input and output

Subject to changes. Please also observe the further product documentation!

WAGO GmbH & Co. KG  
Hansastr. 27  
32423 Minden  
Phone: +49571 887-0 | Fax: +49571 887-169  
Email: [info.de@wago.com](mailto:info.de@wago.com) | Web: [www.wago.com](http://www.wago.com)

Do you have any questions about our products?  
We are always happy to take your call at +49 (571) 887-44222.



- Fast and maintenance-free CAGE CLAMP® connection – a locking slide keeps the clamping unit in its open position
- Externally operable switch to activate or deactivate the network terminating resistor

For the first and last station on the bus, the switch must be set to "ON" (Terminating resistor activated)  
Switch setting to "OFF" for downstream bus stations  
(Terminating resistor deactivated)

## Data

### Technical data

Connection type	D-sub 9 socket
Pole number	9
Communication/fieldbus	CANopen
Baud rate	10 kBd ... 1 MBd (per CANopen specification)

### Connection data

Connection type 1	CAGE CLAMP® terminal strip with locking slide (218 Series)
Solid conductor	0.08 ... 0.5 mm <sup>2</sup> / 28 ... 20 AWG
Strip length	5 ... 6 mm / 0.2 ... 0.24 inches

### Physical data

Width	45 mm / 1.772 inches
Height	16 mm / 0.63 inches
Depth	54 mm / 2.126 inches

### Mechanical Data

Connectable sheathed cable diameter	4.5 ... 9.5 mm
Cable glands (number)	2
Housing material	PA66-105-V2
Weight	27.6 g
Color	light gray

### Environmental requirements

Ambient temperature (operation)	0 ... +60 °C
Ambient temperature (storage)	-25 ... +85 °C
Protection type	IP20

Subject to changes. Please also observe the further product documentation!

Relative humidity (without condensation)	95 %
Vibration resistance	4g per IEC 60068-2-6
Fire load	0.95 MJ

### Commercial data

Product Group	15 (I/O System)
eCl@ss 10.0	27-24-26-92
eCl@ss 9.0	27-24-26-92
ETIM 8.0	EC002584
ETIM 7.0	EC002584
PU (SPU)	1 pcs
Packaging type	bag
Country of origin	DE
GTIN	4045454344405
Customs tariff number	85366990990

### Environmental Product Compliance



RoHS Compliance Status	Compliant, No Exemption
------------------------	-------------------------

### Approvals / Certificates

#### General approvals

Logo	Approval	Additional Approval Text	Certificate name
	UL Underwriters Laboratories Inc. (ORDINARY LOCATIONS)	UL 508	E175199 Sec.1

#### Declarations of conformity and manufacturer's declarations







Logo	Approval	Additional Approval Text	Certificate name
	EU-Declaration of Conformity WAGO GmbH & Co. KG	-	-
	UK-Declaration of Conformity WAGO GmbH & Co. KG	-	-

Subject to changes. Please also observe the further product documentation!



WAGO GmbH & Co. KG  
Hansastr. 27  
32423 Minden  
Phone: +49571 887-0 | Fax: +49571 887-169  
Email: [info.de@wago.com](mailto:info.de@wago.com) | Web: [www.wago.com](http://www.wago.com)

Do you have any questions about our products?  
We are always happy to take your call at +49 (571) 887-44222.

## Approvals for marine applications

Logo	Approval	Additional Approval Text	Certificate name
	<b>ABS</b> American Bureau of Shipping	-	22-2219060
	<b>BV</b> Bureau Veritas S.A.	-	30389/B1 BV
	<b>DNV</b> DNV GL SE	DNV-CG-0339, Aug. 2021	TAA0000194
	<b>KR</b> Korean Register of Shipping	-	KR HMB05880-AC001
	<b>LR</b> Lloyds Register EMEA	-	LR22180952TA
	<b>PRS</b> Polski Rejestr Statków	-	TE/2236/880590/19
	<b>RINA</b> RINA Germany GmbH	-	ELE343521XG001

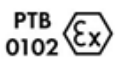
## Approvals for hazardous areas

Logo	Approval	Additional Approval Text	Certificate name
	<b>ATEX</b> TUEV Nord Cert GmbH	EN 60079-0	TUEV_14_ATEX_148929_X (II 3 G Ex ec IIC T4 Gc)
	<b>CCC</b> CNEX	CNCA-C23-01	2020312310000213 (Ex ec IIC T4 Gc)
	<b>EAC</b>	TP TC 012/2011	EAC RU C-DE.AM02.B.00163

Subject to changes. Please also observe the further product documentation!

Brjansker Zertifizierungsstelle

/19 (2Ex nA IIC T4 Gc X)



IECEX  
TUEV Nord Cert GmbH

IEC 60079-0

IECEX TUN 14.0035 X (Ex ec  
IIC T4 Gc)



INMETRO  
TÜV Rheinland do Brasil Ltda.

IEC 60079-0

BR-Ex\_TÜV 12.1297 X



UKEx  
WAGO GmbH & Co. KG

EN 60079-0

UKCA\_WAGO22UKEX003X\_ec

## Downloads

### Documentation

#### Manual

System Manual WAGO I/O System 750/753 Decentralized Automation Technology	V 3.3.0 2023 May 4	pdf 8.8 MB	Download
--	-----------------------	---------------	----------

#### Bid Text

750-963 X81 - Datei	2019 Feb 19	xml 4.6 kB	Download
750-963 doc - Datei	2017 Oct 6	doc 25.1 kB	Download

#### Instruction Leaflet

CCC Ex (Additional information) WAGO-I/O-SYSTEM *750-****/*	2023 Apr 26	pdf 163.6 kB	Download
--	-------------	-----------------	----------

#### Additional Information

Disposal and Recycling Electrical and electronic equipment, Batteries, Packaging	V 1.1.0 2022 Aug 18	pdf 2.2 MB	Download
---	------------------------	---------------	----------

#### System Description

Subject to changes. Please also observe the further product documentation!

WAGO GmbH & Co. KG  
Hansastr. 27  
32423 Minden  
Phone: +49571 887-0 | Fax: +49571 887-169  
Email: [info.de@wago.com](mailto:info.de@wago.com) | Web: [www.wago.com](http://www.wago.com)

Do you have any questions about our products?  
We are always happy to take your call at +49 (571) 887-44222.



Overview on WAGO-I/O-SYSTEM 750 approvals

pdf  
789.0 kB

[Download](#)

## CAD/CAE-Data

### CAD data

2D/3D Models 750-963	<a href="#">URL</a>	<a href="#">Download</a>
----------------------	---------------------	--------------------------

### CAE data

EPLAN Data Portal 750-963	<a href="#">URL</a>	<a href="#">Download</a>
---------------------------	---------------------	--------------------------

WSCAD Universe 750-963	<a href="#">URL</a>	<a href="#">Download</a>
------------------------	---------------------	--------------------------

ZUKEN Portal 750-963	<a href="#">URL</a>	<a href="#">Download</a>
----------------------	---------------------	--------------------------

## Environmental Product Compliance

### Compliance Search

Environmental Product Compliance 750-963	<a href="#">URL</a>	<a href="#">Download</a>
--	---------------------	--------------------------

Fieldbus Connector CANopen; with D-sub female connector; 9-pole

## Installation Notes

Subject to changes. Please also observe the further product documentation!