

AC Filter 3-Stage, Very High Broad Band Attenuation



The same image is used for FMW-200

See below:
[Approvals and Compliances](#)

Description

- Line-filter in standard version
- 3 stages
- very high attenuation, broadband

Characteristics

- Designed for highest demands
- High attenuation at maximum resp. asymmetric load independent from the line impedance
- For standard and industrial applications
- Suitable for use in equipment according to IEC/UL 62368-1

References

Alternative: Standard version
 Last order date: 15.12.2023

Weblinks

[pdf data sheet](#), [html datasheet](#), [General Product Information](#), [Approvals](#), [Distributor-Stock-Check](#), [Detailed request for product](#), [Microsite](#)

Technical Data

| | |
|---------------------------------|---|
| Ratings IEC | 4 - 30A @ Ta 40 °C / 250VAC; 50Hz |
| Ratings UL/CSA | 4 - 30A @ Ta 40 °C / 125VAC; 60Hz |
| Leakage Current | industrial < 1.5mA (250V / 60Hz) |
| Dielectric Strength | > 1.7 kVDC between L-N > 2.7 kVDC between L/N-PE Test voltage (2 sec) |
| Allowable Operation Temperature | -25 °C to 100 °C |
| Climatic Category | 25/100/21 acc. to IEC 60068-1 |
| Protection Class | Suitable for appliances with protection class I acc. to IEC 61140 |
| Terminal | Screw |
| Material | Metal |

| | |
|-------------|--|
| Line Filter | Industrial version, IEC 60939, UL 1283, CSA C22.2 no. 8 Technical Details |
| MTBF | > 200'000h acc. to MIL-HB-217 F |

Approvals and Compliances

Detailed information on product approvals, code requirements, usage instructions and detailed test conditions can be looked up in [Details about Approvals](#)

SCHURTER products are designed for use in industrial environments. They have approvals from independent testing bodies according to national and international standards. Products with specific characteristics and requirements such as required in the automotive sector according to IATF 16949, medical technology according to ISO 13485 or in the aerospace industry can be offered exclusively with customer-specific, individual agreements by SCHURTER.

Approvals



The approval mark is used by the testing authorities to certify compliance with the safety requirements placed on electronic products.

Approval Reference Type: FMW-150 (200)

| Approval Logo | Certificates | Certification Body | Description |
|---------------|-------------------------------|--------------------|------------------------------|
| | VDE Approvals | VDE | Certificate Number: 40004673 |
| | UL Approvals | UL | UR File Number: E72928 |

Product standards

Product standards that are referenced

| Organization | Design | Standard | Description |
|--|-----------------------|-----------------|--|
|  | Designed according to | IEC 60939 | Passive filters for suppressing electromagnetic interference |
|  | Designed according to | UL 1283 | Electromagnetic interference filters |
|  | Designed according to | CSA C22.2 no. 8 | Electromagnetic interference (EMI) filters |





Application standards

Application standards where the product can be used

| Organization | Design | Standard | Description |
|--|--------------------------------|----------------|---|
|  | Suitable for applications acc. | IEC/UL 62368-1 | Audio/video, information and communication technology equipment - Part 1: Safety requirements |

Compliances

The product complies with following Guide Lines

| Identification | Details | Initiator | Description |
|--|--|-------------|---|
|  | CE declaration of conformity | SCHURTER AG | The CE marking declares that the product complies with the applicable requirements laid down in the harmonisation of Community legislation on its affixing in accordance with EU Regulation 765/2008. |
|  | UKCA declaration of conformity | SCHURTER AG | The UKCA marking declares that the product complies with the applicable requirements laid down in the British Amendment of Regulation (EC) 765/2008. |
|  | RoHS | SCHURTER AG | Directive RoHS 2011/65/EU, Amendment (EU) 2015/863 |
|  | China RoHS | SCHURTER AG | The law SJ / T 11363-2006 (China RoHS) has been in force since 1 March 2007. It is similar to the EU directive RoHS. |
|  | REACH | SCHURTER AG | On 1 June 2007, Regulation (EC) No 1907/2006 on the Registration, Evaluation, Authorization and Restriction of Chemicals 1 (abbreviated as "REACH") entered into force. |

Dimension [mm]

Case 43

Case 22

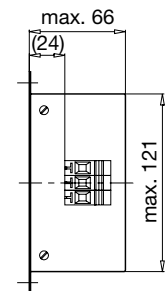
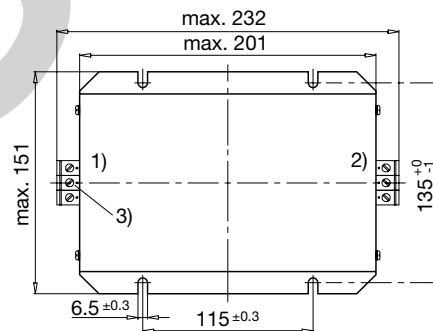
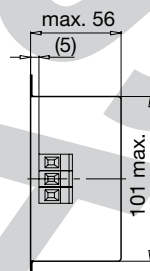
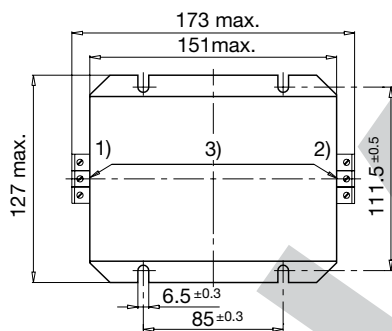

- 1) Line
- 2) Load
- 3) I/O connections torque 0.6...0.8 Nm

- 1) Line
- 2) Load
- 3) I/O connections torque 1.5...1.8 Nm

Diagrams

Standard version

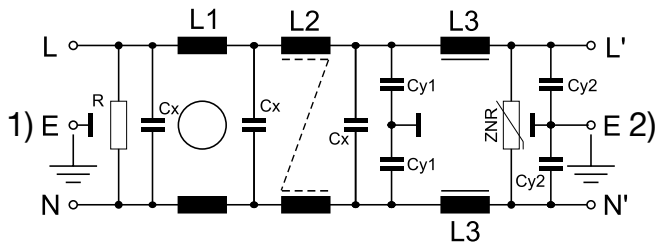

- 1) Line
- 2) Load

Attenuation Loss

Industrial version

----- 50Ω differential mode _____ 50Ω common mode

4 A

10 A

30 A

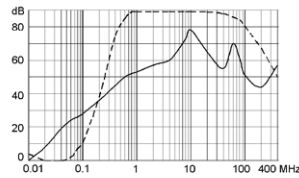
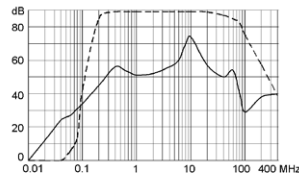
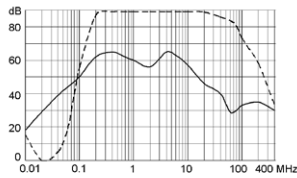

All Variants

| Rated Current [A] | Filter-Type | Leakage Current [mA] | L1 [mH] | L2 [μH] | L3 [μH] | Cx [nF] | Cy1 [nF] | Cy2 [nF] | R [MΩ] | Clamps [mm ²] | Weight [kg] | Housing | Order Number |
|-------------------|--------------------|----------------------|---------|---------|---------|---------|----------|----------|--------|---------------------------|-------------|---------|--------------|
| 4 | Industrial version | 3.5 | 2 x 20 | 2 x 30 | 3 | 220 | 33 | 2.2 | 0.5 | 4 | 1600 g | 43 | 5500.2048 |
| 10 | Industrial version | 1.5 | 2 x 5 | 2 x 30 | 3 | 220 | 15 | - | 0.5 | 4 | - | 43 | 5500.2049 |
| 30 | Industrial version | 1.5 | 2 x 4 | 2 x 17 | 3 | 220 | 15 | - | 0.5 | 6 | 3220 g | 22 | 5500.2050 |

Availability for all products can be searched real-time: <https://www.schurter.com/en/Stock-Check/Stock-Check-SCHURTER>

Packaging unit

1 Pcs